

# PHANTOM 3

STANDARD

User Manual V1.4

2015.10

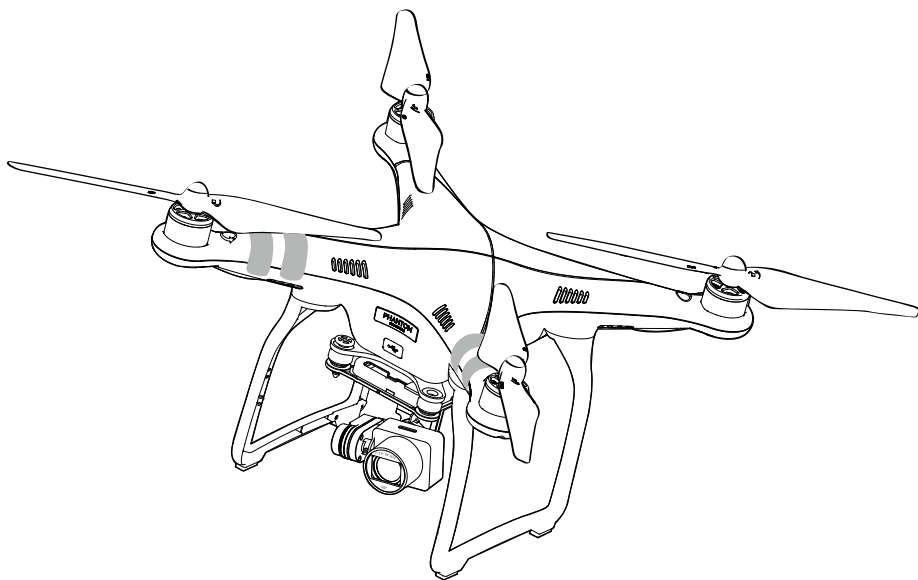

## Searching for Keywords

Search for keywords such as “battery” and “install” to find a topic. If you are using Adobe Acrobat Reader to read this document, press Ctrl+F on Windows or Command+F on Mac to begin a search.

## Navigating to a Topic

View a complete list of topics in the table of contents. Click on a topic to navigate to that section.

# Using this Manual

## Legends

 Warning

 Important

 Hints and Tips

 Reference

## Readings

Read the following documents before using your Phantom 3 Standard.

1. *In the Box*
2. *Phantom 3 Standard User Manual*
3. *Phantom 3 Standard Quick Start Guide*
4. *Phantom 3 Standard Guidelines and Disclaimer*
5. *Phantom 3 Standard Intelligent Flight Battery Safety Guidelines*

To prepare for your first flight, follow the steps in the Phantom 3 Standard Quick Start Guide. Read the Guidelines and Disclaimer to understand your legal rights and responsibilities.

## Video Tutorials

These tutorials will guide you all the way through unboxing, updating the firmware, and your maiden flight.  
<http://www.dji.com/product/phantom-3-standard/video>



## DJI GO App

Download the DJI GO app on the App Store or Google Play, or by scanning the QR code on the right.



The DJI GO app supports iOS 8.0 and Android 4.1.2, or later versions.

# Contents

## Using this Manual

Legends	2
Readings	2
Video Tutorials	2
DJI GO App	2

## Product Profile

Introduction	6
Key Features	6
Preparing the Aircraft and Remote Controller	7
Aircraft Diagram	8
Remote Controller Diagram	8

## Aircraft

Flight Controller	10
Flight Modes	10
LED Indicators	10
Return-to-Home (RTH)	11
Smart RTH	11
Low Battery RTH	12
Failsafe RTH	13
Flight Data	14
Attaching and Detaching the Propellers	14
Intelligent Flight Battery	15

## Remote Controller

Profile	21
Controls and Operation	21

## Camera and Gimbal

Camera	28
Gimbal	29

## **DJI GO App**

Equipment	32
Library	35
Explore	35
Me	35

## **Flight**

Flying Conditions	37
Flight Limits and No Fly Zones	37
Pre-flight Checklist	41
Calibrating the Compass	41
Auto Takeoff and Landing	42
Starting and Stopping the Motors	43
Flight Test	43

## **FAQ**

## **Appendix**

Specifications	50
Firmwares Update	52
Intelligent Flight Mode	52
After-Sales Information	52
FCC Compliance	53



# Product Profile

---

This section introduces the features of the aircraft and remote controller.

# Product Profile

## Introduction

The Phantom 3 Standard is an easy-to-fly quadcopter for aerial photography and filmmaking. It includes a high-quality camera, custom-built remote controller, and Intelligent Flight Battery, and is compatible with the DJI GO app for mobile devices.

## Key Features

**Camera and Gimbal:** The built-in camera captures video at 2.7K and 12 megapixel photos. A 3-axis gimbal holds the camera stable and steady as you fly, resulting in shake-free footage every time.

**Intelligent Flight Battery:** A 4480 mAh lithium polymer Intelligent Flight Battery features an advanced power management system, and provides up to 25 minutes of flight time.

**WiFi Video Downlink:** Live HD video is streamed from the camera to the DJI GO app over WiFi as you fly. A WiFi range extender is built into the remote controller.

**Flight Controller:** Flying is easy and safe with a flight controller optimized to enable controlled, stable flight. Critical flight data is collected, computed and communicated to the entire aircraft in real time.

## Preparing the Aircraft and Remote Controller

### Removing the Gimbal Clamp

Slide the gimbal clamp off the camera.

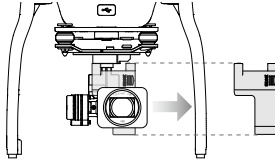

### Attaching the Propellers

Attach the black propeller nuts onto the motors with black dots and spin them counter-clockwise to secure. Attach the silver propeller nuts onto the motors without black dots and spin them clockwise to secure.

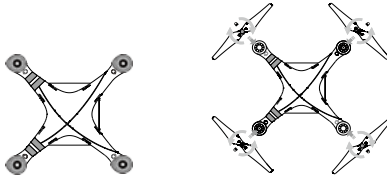

 Tighten the propellers with both hands before each flight.

### Battery Installation

Slide battery into the battery compartment according to the arrow's direction shown below. Make sure that you hear a click sound indicates the battery is firmly installed. Failure to do so may affect the flight safety of your aircraft.

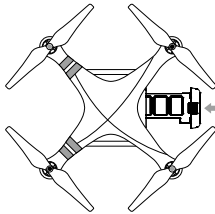

### Preparing the Remote Controller:

1. Unfold the mobile device holder and adjust its position and angle.
2. Slide the power switch to the right to turn on the remote controller. Ensure the battery is fully charged.
3. Be sure the S1 switch is toggled to the upper most position. The Status LED will become solid green if the remote controller is functioning properly.

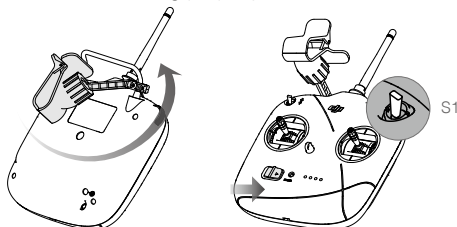

## Aircraft Diagram

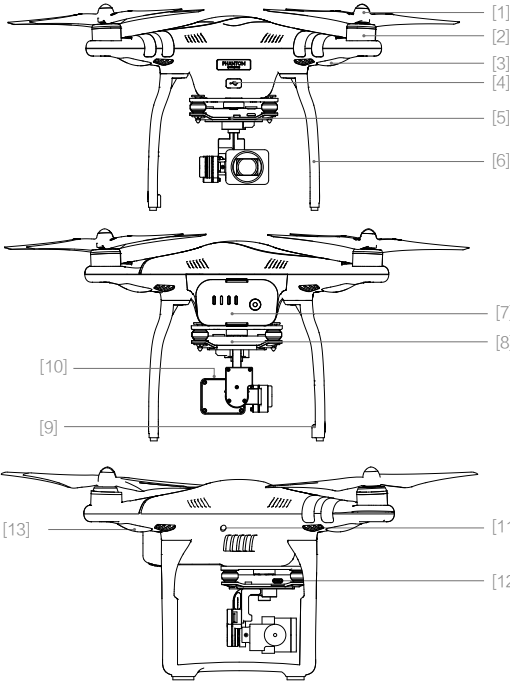

- [1] Propellers
- [2] Motors
- [3] Front LED Indicator
- [4] Aircraft Micro USB Port
- [5] Camera Status Indicator
- [6] Landing Gear
- [7] Intelligent Flight Battery
- [8] Gimbal and Camera
- [9] Antennas
- [10] Camera Micro SD card slot
- [11] Link Button
- [12] Camera Micro USB Port
- [13] Aircraft Status Indicator

## Remote Controller Diagram

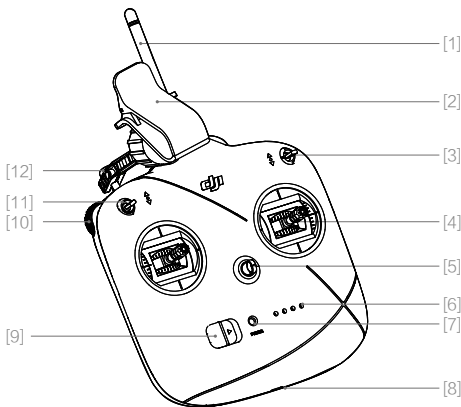

- [1] Antenna
- [2] Mobile Device Holder
- [3] Switch S1
- [4] Control Sticks
- [5] Lanyard Loop
- [6] Battery Level Indicator
- [7] Status LED
- [8] Micro USB Charging Port
- [9] Power Switch
- [10] Gimbal Dial
- [11] Switch S2
- [12] Handle Bar

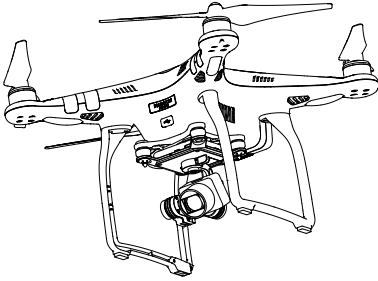

## Aircraft

---

This section introduces the features of the flight controller and the Intelligent Flight Battery.

# Aircraft

## Flight Controller

The flight controller provides stability, safety and control to the Phantom 3 Standard. The supported flight modes are designed to optimize aircraft control for different conditions and purposes. The flight controller allows the aircraft to automatically Return-to-Home (RTH) if the remote controller signal is lost (i.e. Failsafe RTH) or when instructed to by the pilot (i.e. Smart RTH), ensuring the safe return of your aircraft. Flight data is stored to the device every time you fly and can be accessed anytime.

## Flight Modes

Three flight modes are available. The details of each flight mode are found below:

**P-Mode (Positioning):** P-Mode works best when the GPS signal is strong. One of its two states will be selected by the aircraft automatically depending on GPS signal strength.

**P-GPS:** GPS is available. The aircraft uses GPS for positioning.

**P-ATTI:** GPS is not available. The aircraft only uses its barometer to maintain altitude.

**A-Mode (Attitude):** GPS is not used for positioning, and the aircraft only uses its barometer to maintain altitude. If a GPS signal is present, the aircraft will still return to the last recorded Home Point if the remote controller signal is lost.

**F-Mode (Function):** Intelligent Orientation Control (IOC) is supported in this mode. Refer to the IOC section in the Appendix for more information.

The Flight Mode Switch is locked in P-Mode by default. To enable other flight modes, go to the DJI GO app > Camera View >  > Advanced Settings > Enable Multiple Flight Modes.

## LED Indicators

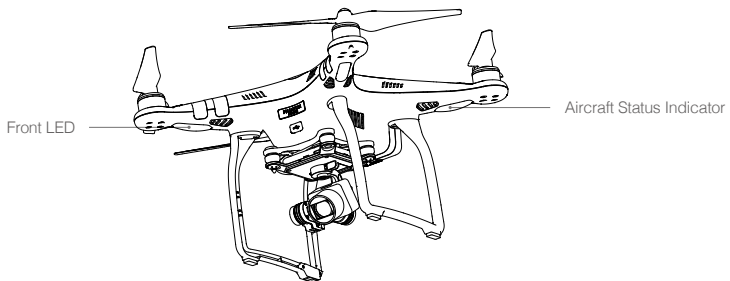

The Phantom 3 Standard has two Front LEDs located under the two front motors and two Aircraft Status Indicators located under the two rear motors.









The Front LEDs glow solid red when the aircraft is turned on and help you orientate the aircraft when it is in the air. You can switch off the Front LEDs in the DJI GO app to achieve a better filming result. The Aircraft Status Indicators indicate the status of the flight controller. See the table below for details of its blinking patterns.

## Aircraft Status Indicator Blinking Patterns

### Normal



	Flashes red, green and yellow alternately	Turning on and running self-diagnostic test
	Flashes green and yellow alternately	Warming up
	Flashes green slowly	Safe to Fly (P-Mode with strong GPS signal)
	Flashes yellow slowly	Safe to Fly (A-mode but No GPS signal)

### Warning

	Flashes yellow quickly	Remote controller's signal lost
	Flashes red slowly	Low Battery Warning
	Flashes red quickly	Critical Battery Warning
	Flashes red (Alternates with other patterns)	IMU error
	Glows solid red	Critical error
	Flashes red and yellow alternately	Compass calibration required

## Return-to-Home (RTH)

The Return-to-Home (RTH) procedure brings the aircraft back to the last recorded Home Point. There are three types of RTH procedures: Smart RTH, Low Battery RTH, and Failsafe RTH. The following sections describe them in detail.

	GPS	Description
Home Point		The Home Point is the location at which the aircraft takes off. A strong GPS signal (  ) must be present for the aircraft to record the Home Point. If the Home Point is recorded successfully, the Aircraft Status Indicator will blink green rapidly.

## Smart RTH

Tap  in the DJI GO app or toggle the S2 switch on the remote controller back and forth at least twice to initiate Smart RTH. The aircraft will first ascend to the Return-to-Home altitude, then return to the last recorded Home Point if a GPS signal is available. During the RTH procedure, you may use the remote controller to guide the aircraft around obstacles.

Tap  or toggle the S1 switch once to terminate Smart RTH and regain full control of the aircraft.

## Low Battery RTH

When the Intelligent Flight Battery is depleted to a point that may affect the safe return of the aircraft, the Low Battery Level Warning or Critically Low Battery Warning will appear in the DJI GO app. The thresholds for these warnings are automatically determined based on the aircraft's current altitude and distance from the Home Point, but you can also set your own fixed thresholds as extra precaution.

Observe the Battery Level Indicator as you fly your aircraft. The **12:29** icon displays the estimated remaining flight time, and the **H** icon represents the point when the battery level is just enough for the aircraft to return to the Home Point. The **12:29** icon gradually moves to the left as the battery is consumed.

When the **12:29** icon enters the yellow region, the Low Battery Level Warning will appear and prompt you to Return-to-Home. The aircraft will automatically return to the Home Point if no action is taken after 10 seconds, but you can resume normal flight by tapping **RTH** or toggling the S1 switch.

When the **12:29** icon enters the red region, the battery level can only support the aircraft to land from its current altitude. The Critically Low Battery Level Warning will appear and the aircraft will begin to descend automatically. You should find a suitable location to land the aircraft immediately.

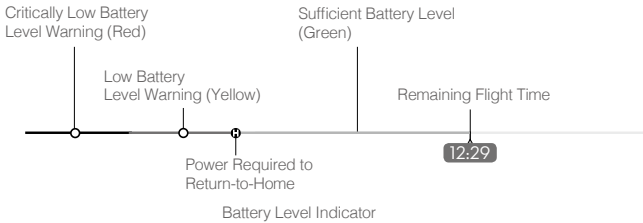

Battery Level Warning	Description	DJI GO App	Aircraft
Low Battery Warning	The battery level is just sufficient for the aircraft to safely return to the Home Point.	Prompts the pilot to start the Return-to-Home procedure.	The Aircraft Status Indicator flashes RED slowly. The aircraft will automatically return to the Home Point if no action is taken after 10 seconds.
Critically Low Battery Level Warning	The battery level can only support the aircraft to land from its current altitude.	Alerts the pilot of the aircraft's automatic descent (cannot be cancelled). The screen will flash RED.	The Aircraft Status Indicator flashes RED quickly. The aircraft begins to descend and land itself automatically.

- While the aircraft is in automatic descent, you can still control the aircraft's movement although its ascent speed is very limited. Use this opportunity to find a suitable landing location.





## Failsafe RTH

Failsafe RTH will be triggered if the remote controller signal is lost for more than three seconds, provided that a Home Point was recorded previously. You can regain control of the aircraft if the remote controller signal is recovered.

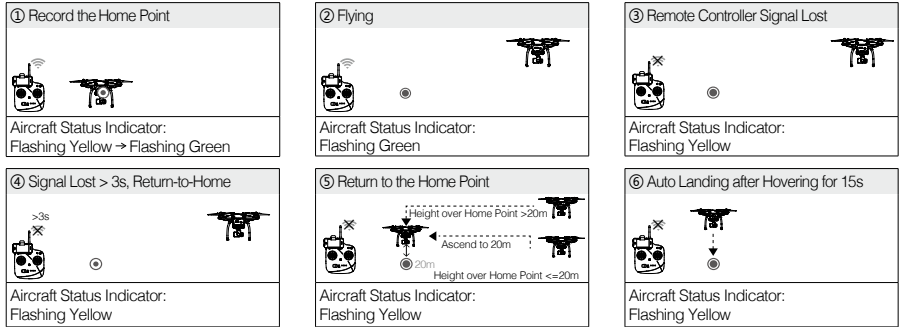
### Failsafe RTH Illustration



- The aircraft will automatically descend and land if Failsafe RTH is triggered when the aircraft is within a 20 meter (65 feet) radius of the Home Point. During the RTH procedure, if you move the throttle stick after the aircraft rises above 65 feet (20m), the aircraft will stop ascending and immediately return to the Home Point.
- The aircraft cannot Return-to-Home if the signal is weak ( [  ] is grey).
- The aircraft cannot avoid obstacles during the Failsafe RTH procedure, and therefore it is important to set a suitable Return-to-Home altitude before each flight. Go to the DJI GO app > Camera View >  > Advanced Settings > Failsafe Mode to set the Failsafe altitude.

### Failsafe Safety Notices



The aircraft cannot avoid obstruction during the Failsafe RTH, therefore, it is important to set an suitable Failsafe altitude before each flight. Launch the DJI GO app and enter "Camera" and select "MODE > Advanced Settings > Failsafe mode" to set the Failsafe altitude.



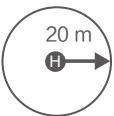

If the aircraft is flying under 20 meters (65 feet) and Failsafe (including Smart RTH, Lower Battery RTH ) is triggered, the aircraft will first automatically ascend to 20 meters (65 feet) from the current altitude. You can only cancel the ascending by exiting the Failsafe. Refer to "Remote Controller Operation" on page 23 for more information on how to exit the Failsafe and regain the control of the remote controller.



Aircraft automatically descends and lands if RTH is triggered when the aircraft flies within a 20 meters (65 feet) radius of the Home Point. Aircraft will stop ascending and immediately return to the Home Point if you move the throttle stick if the aircraft reaches 20 meters (65 feet) altitudes or beyond during Failsafe.



Aircraft cannot return to the Home Point when GPS signal is weak ( [   ] displays grey) or unavailable.







if you move the throttle stick after the aircraft rises above 65 feet (20m) but below the pre-set Failsafe RTH altitude, the aircraft will stop ascending and immediately return to the Home Point.

## Flight Data

The aircraft automatically keeps a record of detailed flight data including telemetry measurements, aircraft status information, and error messages. To export this data, connect the aircraft to the PC through the Micro USB port and launch the DJI GO app to export this data. This data can be later analyzed with the proper software if necessary.

## Attaching and Detaching the Propellers

Only use official DJI Phantom 3 propellers with your Phantom 3 Standard.

Propellers	Silver Propeller Nut	Black Propeller Nut
Figure		
Attach On	Motors without a black dot	Motors with a black dot
Legends	 Lock : Turn the propellers in this direction to secure.  Unlock : Turn the propellers in this direction to loosen.	

### Attaching the Propellers

1. Remove the warning stickers from the motors before attaching the propellers.
2. Attach the black propeller nuts onto the motors with black dots and spin them counter-clockwise to secure. Attach the silver propeller nuts onto the motors without black dots and spin them clockwise to secure.

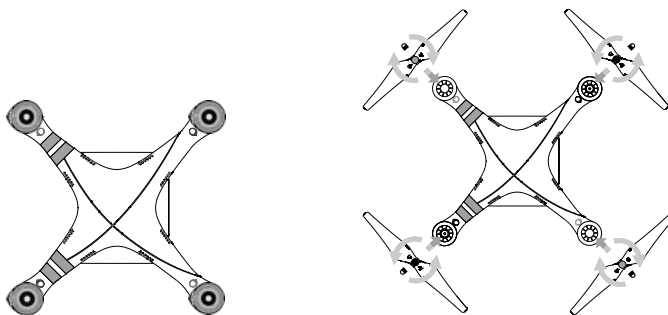

- ⚠️ • Ensure the propellers are attached to the correct motors. Only using the propeller with the same model.
- Tighten the propellers with both hands before each flight.
- Ensure that all propellers are in good condition before each flight. DO NOT use aged, chipped, or broken propellers.
- Stand clear of the motors and DO NOT touch the propellers when they are spinning.

### Detaching the Propellers

Put the propeller removal clamp around the motor, and pinch both sides as shown below to hold the motor in place. Then rotate the propeller in the unlock direction  to loosen it.

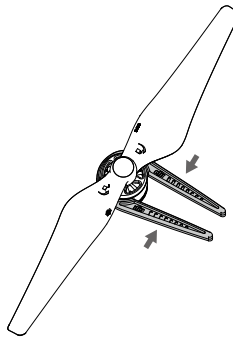

### Intelligent Flight Battery

The DJI Intelligent Flight Battery has a capacity of 4480 mAh, a voltage of 15.2 V and a smart charge/discharge functionality. It should only be charged with the official DJI battery charger.

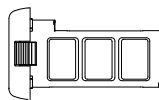

Intelligent Flight Battery

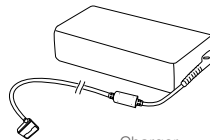

Charger

- ⚠️ • The Intelligent Flight Battery must be fully charged before using it for the first time. Refer to [Charging the Intelligent Flight Battery](#) on page 18 for more information.

- 💡 • Note that the output power of the supplied Phantom 3 Standard charger is 57 W.

### DJI Intelligent Flight Battery Functions

1. **Battery Level Display:** LEDs display the current battery level.
2. **Battery Life Display:** LEDs display the current battery life.
3. **Auto-Discharging Function:** The battery automatically discharges to below 65% of battery level when it is left idle (pressing the power button will exit idle state) for more than 10 days to prevent swelling. It takes about two days to discharge the battery from 100% to 65%, and it is normal to feel moderate heat emitting from the battery during the discharge process. The discharge thresholds can be adjusted in the DJI GO app.
4. **Balanced Charging:** Automatically balances the voltage of each battery cell when charging.
5. **Overcharge Protection:** Automatically stops charging the battery when it is fully charged.
6. **Temperature Detection:** The battery will only charge when its core temperature is between 0°C and 40°C (32°F and 104°F).
7. **Overcurrent Protection:** The battery stops charging when the maximum current of 8A is exceeded.
8. **Over-Discharge Protection:** The battery stops discharging when the battery voltage reaches 12V to prevent damage from over-discharge.
9. **Short Circuit Protection:** Automatically cuts the power supply when a short circuit is detected.
10. **Battery Cell Damage Detection:** The DJI GO app display a warning message if a damaged battery cell is detected.
11. **Battery Log:** Show the last 32 entries of battery information including warning messages.
12. **Sleep Mode:** The battery enters sleep mode after 20 minutes of inactivity to save power.
13. **Communication:** The battery voltage, capacity, current and other relevant information is sent to the flight controller.

---

 Read the *Phantom 3 Standard Intelligent Flight Battery Safety Guidelines* before use. Users take full responsibility for all operations and usage.

---

### Using the Battery

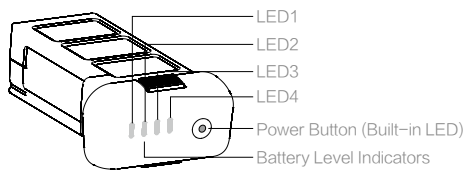

### Turning On or Turning Off the Battery

Press the power button once, again, and hold for 2 seconds.

---

 When turning off the battery, the power button may continue to flash for a few seconds if the aircraft is still storing media files to the Micro SD card.

---

**Low Temperature Environments:**

1. The battery capacity is significantly reduced when flying in cold environments (i.e. air temperatures below 0°C).
2. It is not recommended to fly in very cold environments (i.e. air temperatures below -10°C). Ensure the battery voltage is stable when operating in air temperatures between -10°C and 5°C.
3. End the flight as soon as possible if the Low Battery Level Warning appears when you are flying in low temperature environments.
4. Try to warm up the battery indoors prior to flying in low temperature environments.
5. Keep the battery core temperature above 20°C to ensure optimal performance.
6. The charger will pause the charging process if the battery core temperature is out of operating range (0°C ~ 40°C).





































-  • Ensure the temperature of the Intelligent Flight Battery exceeds 5°C before takeoff.
- To warm up the aircraft battery, power it on inside the battery compartment for approximately 1-2 minutes before takeoff. Begin flying by hovering the aircraft at a low altitude for approximately 1 minute to ensure that the battery temperature is stable.

**Checking the Battery Level**

When the battery is powered off, press the power button once. The Battery Level Indicator will light up to display the current battery level. See the table below for more details.

 The Battery Level Indicators will also show the current battery level during charging and discharging. The LED states are defined below.

-  : LED is on.       : LED is flashing.
-  : LED is off.

LED Patterns				
LED1	LED2	LED3	LED4	Battery Level
				87.5%~100%
				75%~87.5%
				62.5%~75%
				50%~62.5%
				37.5%~50%
				25%~37.5%
				12.5%~25%
				0%~12.5%
				0%

## Checking the Battery Life

The battery life indicates the number of cycles the battery can be charged and discharged before it must be replaced. When the battery is turned off, press and hold the power button for 5 seconds to check the battery life. The Battery Level Indicator will light up with one of the following LED patterns:

LED Patterns				
LED1	LED2	LED3	LED4	Battery Life
□	□	□	□	90%~100%
□	□	□	▤	80%~90%
□	□	□	□	70%~80%
□	□	▤	□	60%~70%
□	□	□	□	50%~60%
□	▤	□	□	40%~50%
□	□	□	□	30%~40%
▤	□	□	□	20%~30%
□	□	□	□	Below 20%

⚠ When the battery life reaches 0%, the Intelligent Flight Battery must be replaced.

☰ For more information about the battery, launch the DJI GO app and tap **100%** in Camera View.

## Charging the Intelligent Flight Battery

1. Connect the battery charger to a suitable power supply (100-240V, 50/60Hz).
2. Open the protection cap on the battery charger and connect it to the Intelligent Flight Battery. If the battery level is above 95%, turn on the battery before charging, otherwise it will not be fully charged.
3. The Battery Level Indicator will display the current battery level as it is charging.
4. The Battery Level Indicators will turn off when charging is complete. Disconnect the Intelligent Flight Battery from the battery charger.

⚠ Always turn off the Intelligent Flight Battery before inserting it into or removing it from the aircraft. Air cool the Intelligent Flight Battery after each flight. Allow its temperature to drop to room temperature before charging it.

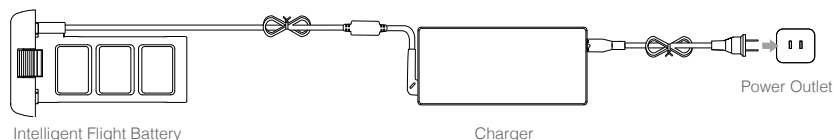

Battery Level Indicators while Charging				
LED1	LED2	LED3	LED4	Battery Level
				0%~25%
				25%~50%
				50%~75%
				75%~100%
				Fully Charged

### Battery Protection Mechanism

The table below shows the LED blinking patterns and their corresponding battery protection warning.

Battery Level Indicators while Charging					
LED1	LED2	LED3	LED4	Blinking Pattern	Battery Protection Warning
				LED2 blinks twice per second	Over current detected
				LED2 blinks three times per second	Short circuit detected
				LED3 blinks twice per second	Overcharge detected
				LED3 blinks three times per second	Charger overvoltage detected
				LED4 blinks twice per second	Charging temperature is too low (<0°C)
				LED4 blinks three times per second	Charging temperature is too high (>40°C)

After any of the above protection issues are resolved, press the power button to turn off the battery protection warning. Unplug the Intelligent Flight Battery from the battery charger and plug it back in to resume charging. Note that you do not need to unplug and plug the battery charger in the event of a room temperature error; the battery charger will resume charging when the temperature falls within the normal range.

DJI does not take any responsibility for damage caused by third-party battery chargers.

### Discharging the Intelligent Flight Battery

**Slow** : Place the Intelligent Flight Battery into the Phantom 3 Standard's battery compartment and turn it on. Leave it on until there is less than 8% of battery remaining, or until the battery can no longer be turned on. Check the battery level in the DJI GO app.

**Fast** : Fly the Phantom 3 Standard outdoors until there is less than 8% of battery remaining or until the battery can no longer be turned on.

# Remote Controller

---

This section describes the features of the remote controller, and includes instructions for controlling the aircraft and the camera.

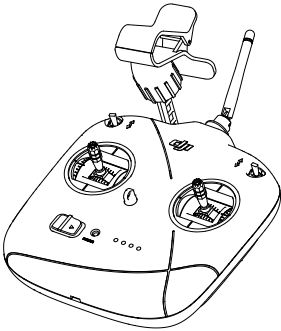



# Remote Controller

## Profile

The Phantom 3 Standard remote controller features a 2.4 GHz WiFi Video Downlink, 5.8 GHz aircraft transmission system, and a built-in battery. It is capable of transmitting signals to the aircraft at up to 0.62 miles (1 km). There is a foldable mobile device holder attached to the remote controller used to mount your smartphone.

- ☰ • **Compliance:** The remote controller is made to comply with both CE and FCC standards.
- **Operating Modes:** The controls can be set to Mode 1, Mode 2 or a custom mode.
- **Mode 1:** The right stick serves as the throttle.
- **Mode 2:** The left stick serves as the throttle.

☀️ The mobile device holder can be tilted at different positions and angles.

⊘ DO NOT force an overlarge mobile device into the mobile device holder.

## Controls and Operation

### Powering on the Remote Controller

1. Toggle the S1 switch to the upper most position and ensure both control sticks are in the neutral position.
2. Slide the power switch to the right to turn on the remote controller.
3. The Status LED will light up solid green when the remote controller is connected to the aircraft. The Battery Level Indicator will display the battery level of the remote controller.

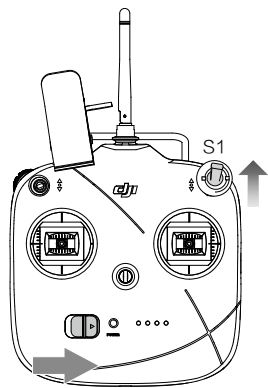







### Charging the Remote Controller



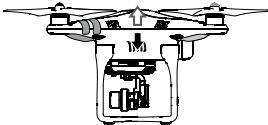

Charge the remote controller through the Micro USB port using the provided Micro USB cable. The Battery Level Indicator will blink green when it is charging.

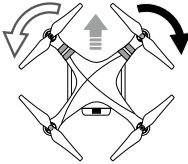
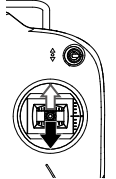
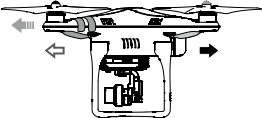
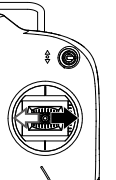
## Remote Controller Operation

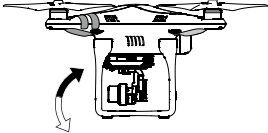
The remote controller is set to Mode 2 by default.

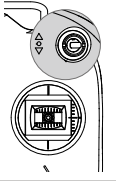
 Neutral Position: The control stick is released and in the central position.

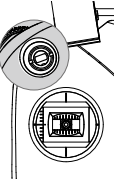
Remote Controller	Aircraft (  Indicates nose direction)	Operation
		<p>Vertical movement of the left stick controls the aircraft's elevation. Push up to ascend and press down to descend.</p> <p>Use the left stick to take off when the motors are spinning at idle speed. The aircraft will hover in place if the stick is in the neutral position.</p>
		<p>Horizontal movement of the left stick controls the aircraft's heading. Move left to rotate the aircraft counter clock-wise and move right to rotate the aircraft clockwise.</p>
		<p>Vertical movement of the right stick controls the aircraft's pitch. Push up to fly forwards and press down to fly backwards.</p> <p>Move the stick further for a larger pitch angle and faster flight.</p>
		<p>Horizontal movement of the right stick controls the aircraft's roll. Move the stick left to fly left and right to fly right.</p> <p>Move the stick further for a larger roll angle and faster flight.</p>
		<p>Turn the Gimbal Dial to the right to tilt the camera upwards, and to the left to tilt the camera downwards.</p>

	 <p>Position 1   Position 2   Position 3</p>	<p>Toggle the S1 switch back and forth multiple times to regain the control of the aircraft during Failsafe RTH.</p> <p>Toggle the S1 switch back and forth for more than 3 times to calibrate the aircraft's compass.</p> <p>Toggle the S1 switch to position 1 to enable P-Mode, to position 2 to enable A-Mode, and to position 3 to enable F-Mode.</p>
	 <p>Position 1   Position 2   Position 3</p>	<p>Toggle the S2 switch back and forth at least twice to initiate Smart RTH. Use the S2 switch and the gimbal dial to link with the aircraft and reset the WiFi password. Refer to <a href="#">Linking the Remote Controller</a> on page 24 and <a href="#">Resetting the WiFi Video Downlink</a> on page 26 for more details.</p>

-  • The aircraft will hover in place when both sticks are released and GPS is available.
- If GPS is not available, the aircraft will lock its altitude but drift from side to side.

### Battery Level Indicator

The figure below illustrates the four battery levels that are displayed by the Battery Level Indicator on the remote controller's front panel.

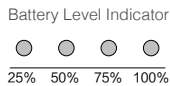

-  Always ensure the remote controller has an adequate battery level before each flight. If the battery level is critically low, the remote controller will sound an alert and its Status LED will blink red for 3 seconds before automatically powering off. If the remote controller powers off during flight, the aircraft will enter Failsafe RTH.

### Optimal Transmission Range

To achieve optimal transmission, point the top of the remote controller at the aircraft, and adjust the antenna so that it is parallel to the aircraft's legs (or simply tilt it at a 45 degree angle).

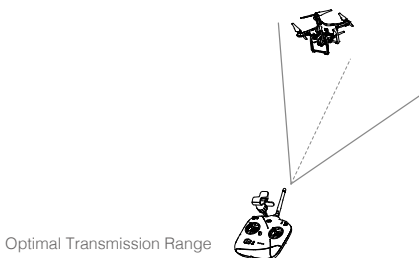

## Linking the Remote Controller

The Phantom 3 Standard is linked to the remote controller by default, and re-linking is only necessary if the remote controller is replaced with a new one. Refer to the figure below to locate the Link Button.

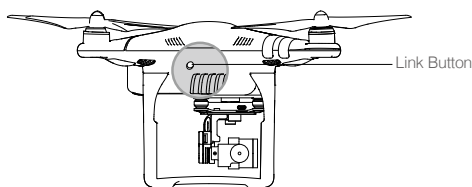

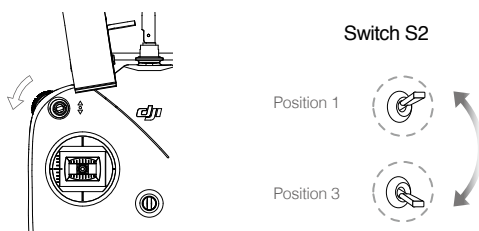

### Linking Procedures

1. Turn on the aircraft and press the Link Button. The button will blink red when the aircraft is ready to link.
2. Switch on the remote controller, turn the gimbal dial to the far left, and toggle the S2 switch back and forth quickly for at least three times. You will hear a pulsating beep sound when the remote controller is trying to link to the aircraft.
3. The remote controller will stop beeping and the Link Button on the aircraft will turn solid green if linking is successful.



### Linking Status







Link Button	Description	User Action
 — Glows solid red	No RC signal	Switch on the RC or perform a linking procedure
 .....Blinks red	Ready to link	Switch on the RC
 — Glows solid green	Linked to RC	Linking successful

### CE or FCC Compliance

The remote controller complies with CE compliance as default. Switch between CE and FCC is automatically adjusted according to the GPS locations acquired by the DJI GO app.

- ⚠ • The CE compliant remote controller has an effective signal range of 0.31 miles (500 m) in open spaces.
- The FCC compliant remote controller has an effective signal range of 0.62 miles (1000 m) in open spaces.
- Be aware of your flying distance as the aircraft will enter Failsafe RTH if it flies beyond transmission range.

### Remote Controller Status LED Description

Status LED	Sound	Remote Controller Status
 — Solid green	None	Functioning normally and fully charged.
 — Solid red	None	Charging (remote controller is powered off). Remote controller is not connected to the aircraft.
 — Solid yellow	None	Control stick calibration error. Battery fully charged but remote controller is not connected to the aircraft.
 ..... Blinks red slowly	BB---BB---BB	Low battery level. Recharge the remote controller.
 ..... Blinks red quickly	B-B-B...	Critically low battery level, the remote controller will automatically power off after 3 seconds / The remote controller is switched on with the control stick not in the neutral position.
 ..... Blinks green slowly	B--B--B...	Inactivity for over 6 minutes. Switch off the remote controller if it is not in use.

### WiFi Video Downlink

Used to boost the transmission range between the on-board camera and the remote controller, the 2.4 GHz WiFi video downlink is integrated into the remote controller and provides the device with an effective communication range of up to 0.62 miles (1000 m). It also enables the remote controller to connect to the DJI GO app wirelessly.

#### Connecting to the WiFi Video Downlink:

1. Switch on the remote controller.
2. Turn on the aircraft.
3. On your mobile device, select 'PHANTOM3\_XXXXXX' from the WiFi network list, and enter the default password '12341234'.
4. Launch the DJI GO app and enter Camera View. A video signal from the aircraft's camera indicates that the aircraft has established a connection to the WiFi video downlink successfully.

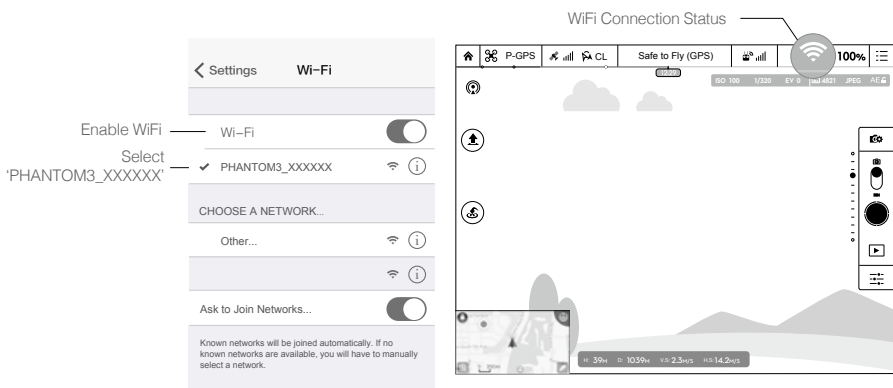

- Refer to [DJI GO App](#) on page 32 for more information on how to change the SSID and password for the WiFi video downlink.

## Resetting the WiFi Video Downlink

Switch on the remote controller, turn the gimbal dial to the far right, and toggle the S2 switch back and forth for at least three times. The remote controller will sound a long beep if the SSID and password for the WiFi Video Downlink have been reset to their default values successfully.

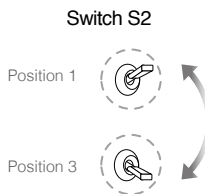
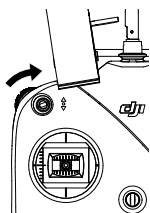

## Camera and Gimbal

---

This section provides the technical specifications of the camera and explains the gimbal's operation modes.

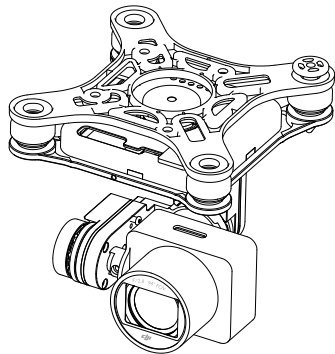

# Camera and Gimbal

## Camera

The on-board camera features a 1/2.3 inch CMOS sensor that captures up to 2.7k Ultra HD video at 30fps and 12 MP still photos. Video can be recorded in MOV or MP4 format, while stills can be saved in both JPEG and DNG formats. Shooting modes include burst, AEB and time-lapse. A live HD video feed from the camera can be viewed on your mobile device through the DJI GO app.

## Video and Photo Storage

The Phantom 3 Standard comes with an 8 GB Micro SD, but also supports Micro SD cards with a capacity of up to 64 GB. It is recommended using a UHS-1 or Class 10 Micro SD card to minimize the delay when reading or writing high resolution image files.

Gimbal Camera

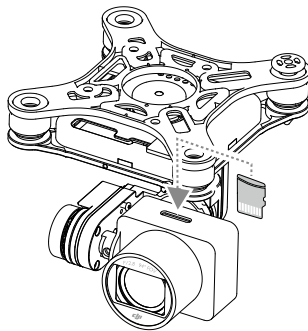

---

⊘ DO NOT insert or remove the Micro SD card when the Phantom 3 Standard is turned on.

---

## Downloading Videos and Photos

Connect the Phantom 3 Standard to your PC through the Camera Micro USB Port to access videos and photos stored on the Micro SD card.

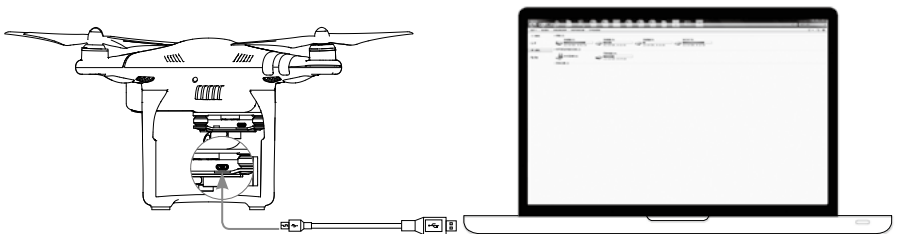

---









⚠ The aircraft must be turned on in order to access the files on the Micro SD card.

---



## Camera Status LED

The Camera Status LED lights up when the aircraft is turned on and provides information on the working status of the camera.

Blinking Pattern	Camera Status
 Blinks green quickly (0.1s on, 0.2s off)	System is warming up
 Blinks green once (0.4s on, 0.5s off)	Taking a single shot
 Blinks green three times (0.1s on, 0.3s off)	Taking 3/5/7 burst shots
 Blinks red slowly (1.6s on, 0.8s off)	Recording video
 Blinks red quickly (0.2s on, 0.5s off)	SD card error
 Blinks red twice (0.1s on, 0.1s off X2)	Camera overheated
 Glows solid red	System error
 Blinks green and red alternatively (0.8s green, 0.8s red)	Firmware updating

## Gimbal

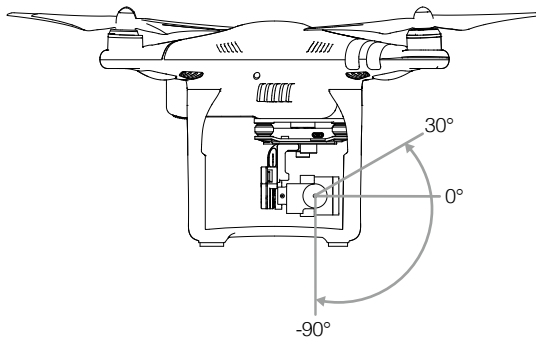

The 3-axis gimbal provides a steady platform for the camera attached, allowing you to capture crisp, clear images. The gimbal can tilt the camera across a 120° range.



Use the gimbal dial on the remote controller to control the tilt motion of the camera.

## Gimbal Operation Modes

Two gimbal operation modes are available. Switch between the different operation modes on the camera settings page of the DJI GO app. Note that your mobile device must be connected to the remote controller for changes to take effect. Refer to the table below for details:

	Follow Mode	The pitch angles of the gimbal and the aircraft stay the same.	
		FPV Mode	The pitch and roll angles of the gimbal and the aircraft stay the same, providing a unique first-person view.



- Take off from a flat, open ground that will not interfere with the gimbal movement.  
A gimbal motor error may occur in these situations:
  - (1) The gimbal's motion is obstructed by the gimbal clamp or obstacles on the ground.
  - (2) The gimbal was subjected to an excessive external force such as a collision.
- Flying in heavy fog or clouds may make the gimbal wet, leading to a temporary failure. The gimbal will recover full functionality once it dries.

## Anti-Drop Kit

The Phantom 3 Standard comes with two Anti-Drop Pins which help secure the gimbal and camera to the aircraft. To install additional pins, follow these steps:

Push the Anti-Drop Pin through the damper and the center of the ring. Press them together until you hear a click. Only 2 pins installed adjacent from each other are required during use.

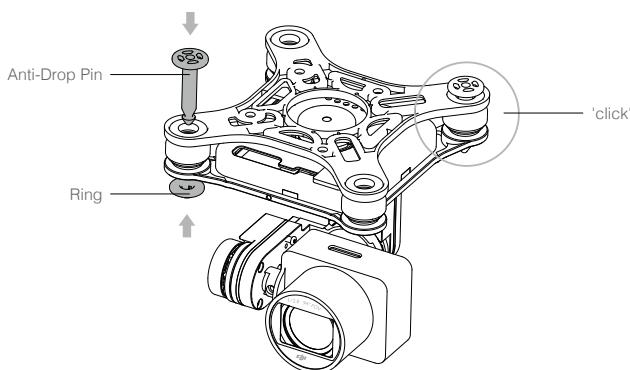

## DJI GO App

---

This section introduces the four main pages in the DJI GO app.

# DJI GO App

The DJI GO app is an essential hub to operate your DJI equipment, share your artwork, explore the community, and manage your DJI account, all at once. These features correspond to the four pages – Equipment, Library, Explore and Me - which are introduced in detail below.

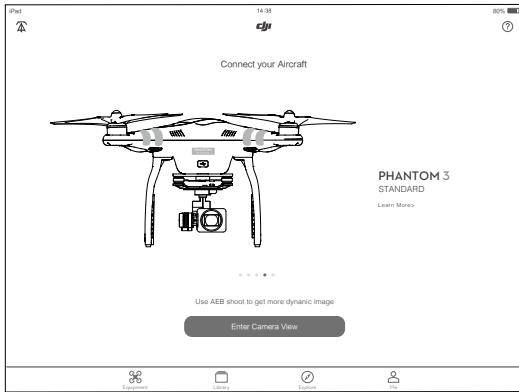

## Equipment

On the Equipment page, you can enter Camera View, visit the Academy or view your flight records.

### Camera View

The Camera View is the main panel for operating your aircraft. The center of the screen contains a live HD video feed from the camera, and around it are icons and buttons that give you control over the aircraft and camera.

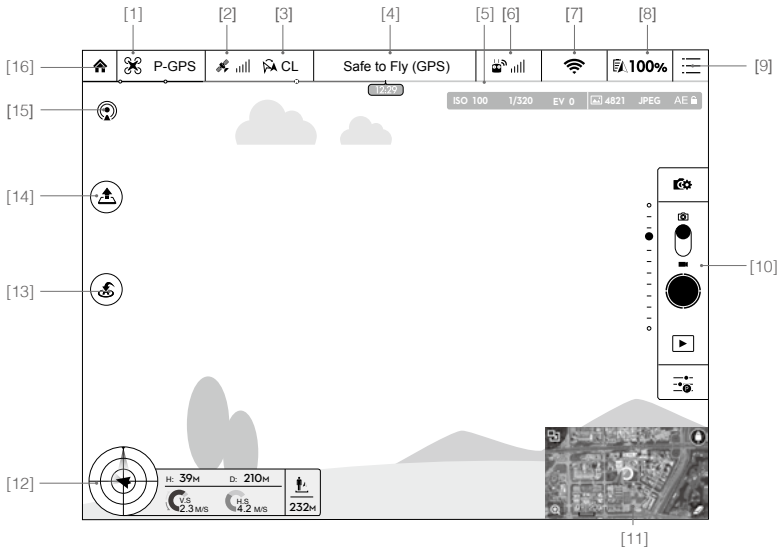

**[1] Flight Mode**

 : The current flight mode is displayed next to this icon.

Tap to enter the Main Controller Settings, where you can configure the parameters that affect flight behavior.



The aircraft is in Beginner Mode by default, and cannot fly 30 meters (98 feet) above or away from the Home Point. You can disable Beginner Mode in the Main Controller Settings.

**[2] GPS Signal Strength**

 : Shows the current GPS signal strength. Green bars indicate an adequate GPS strength.

**[3] IOC Settings**

 **CL** : Displays the IOC settings when the aircraft is in F-Mode. Tap this icon to view the IOC menu and select the desired IOC mode.

**[4] System Status Bar**

 : Indicates the current aircraft system status and GPS signal strength.

**[5] Battery Level Indicator**

 : Describes the battery level of the aircraft according to its immediate status. The colored zones represent the various thresholds of battery level. When the battery level drops below a certain threshold, the system will prompt the user to take the appropriate action.

**[6] Remote Controller Signal**

 : Shows the signal strength of the remote controller.

**[7] Video Downlink Signal**

 : Shows the signal strength of the WiFi Video Downlink between the aircraft and the remote controller. Tap to set the SSID and connection password for the WiFi connection.

**[8] Battery Level**

 **100%** : Shows the current battery level. Tap to view the Aircraft battery menu, where you can view battery information and set the battery warning thresholds.

**[9] General Settings**

 : Tap to view the settings for the camera, mini-map and video cache.

**[10] Camera Bar****Camera Operations**

 : Tap to enter various camera value settings, including color space for the recording, resolution of the videos, image size and so on.

**Shutter (Photo)**

 : Tap once to take a single photo. Tap and hold to switch between shooting modes.

**Shutter (Video)**

 : Tap to start or stop recording video.

**Playback**

 : Tap to play back photos and videos on the Micro SD card.

**Camera Settings**

 : Tap to set the ISO, shutter speed and auto exposure values.

**[11] Map**

Shows the current position of the aircraft. Tap the map to switch from Camera View to Map View.



**[12] Flight Telemetry**

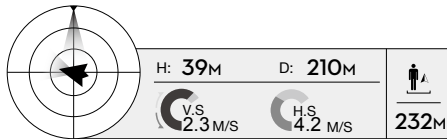

The radar-like object indicates the aircraft's attitude. Tap to bring up the Map.

- (1) The red arrow indicates the aircraft's heading.
- (2) The ratio between the blue and gray areas indicates the aircraft's pitch.
- (3) The horizontal level of the blue-gray boundary indicates the aircraft's roll angle.

**[13] Return-to-Home (RTH)**

 : Initiates the RTH procedure. Tap to bring the aircraft back to the last recorded Home Point.

**[14] Auto Takeoff/Landing**

 : Tap to initiate auto takeoff or landing.

**[15] Livestream**

 : Indicates that a video feed is being broadcast live on YouTube. Be sure that your mobile device is connected to the internet.

**[16] Back**

 : Tap to return to the main menu.

## Library

View, edit and share your artwork all in one place. The Library has a range of simple but powerful tools that let you edit your videos and photos before sharing them online, minutes after they are captured.

## Explore

Find out about our latest events, featured products and trending Skypixel uploads in the Explore page.

## Me

If you already have a DJI account, you will be able to participate in forum discussions, earn Credits in the DJI Store, and share your artwork with the community.

# Flight

---

This section describes safe flight practices and flight restrictions.



# Flight

Once pre-flight preparation is complete, it is recommended that you use the flight simulator in the DJI GO app to practice flying or have an experienced pilot accompany you for supervision. Ensure that all flights are carried out in an open area.

## Flying Conditions

1. DO NOT use the aircraft in adverse weather conditions including rain, snow, fog, and wind speeds exceeding 10 m/s.
2. Only fly in open areas. Tall buildings and steel structures may affect the accuracy of the on-board compass and GPS signal.
3. Avoid flying near obstacles, crowds, high voltage power lines, trees and bodies of water.
4. Avoid flying in area with high levels of electromagnetism, including mobile phone base stations and radio transmission towers.
5. Aircraft and battery performance is subject to environmental factors such as air density and temperature. Be very careful when flying over 19685 feet (6000 m) above sea level as the battery and aircraft performance may be reduced.
6. The Phantom 3 Standard cannot operate in P-Mode within the Earth's polar regions.

## Flight Limits and No Fly Zones

Unmanned aerial vehicle (UAV) operators should abide by the regulations from self-regulatory organizations such as the International Civil Aviation Organization (ICAO), the Federal Aviation Administration (FAA) and their local aviation authorities. For safety reasons, flight limits are enabled by default to help users use this product safely and legally.

When operating the aircraft in P-Mode, the altitude limit, radius limit and No Fly Zones work together to bound the aircraft. In A-Mode, the aircraft cannot exceed altitudes of 400 feet (120 m).

### Altitude and Radius Limits

The pilot can set the altitude and radius limits in the DJI GO app to create a cylindrical geo-fence to bound the aircraft. The tables below show the details of these limits.

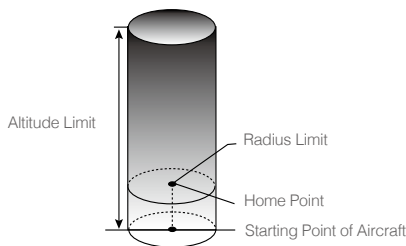

Strong GPS Signal  ..... Flashing Green			
	Flight Limits	DJI GO App	Aircraft Status Indicator
Max Height	Flight altitude must be below the preset height.	Warning: Height limit reached.	None.
Max Radius	Flight distance must be within the max radius.	Warning: Distance limit reached.	Flashes red rapidly when the aircraft approaches the max radius limit.

Weak GPS Signal  ..... Flashing Yellow			
	Flight Limits	DJI GO App	Aircraft Status Indicator
Max Height	Flight height restricted to Max Height under 400 ft (120 m).	Warning: Height limit reached.	None.
Max Radius	No limit		



- If you fly out of bounds, you can still control the aircraft, but cannot fly it further.
- If the aircraft loses GPS signal and flies out of the max radius but regains GPS signal afterwards, it will fly back within range automatically.

## No Fly Zones

All No Fly Zones are listed on the DJI official website at <http://flysafe.dji.com/no-fly>. No Fly Zones are divided into Airports and Restricted Areas. Airports include major airports and flying fields where manned aircraft operate at low altitudes. Restricted Areas include borders between countries or sensitive sites. The details of the No Fly Zones are explained below.

### Airports (Requires GPS):

1. Airport No Fly Zones are comprised of Takeoff Restricted Zones and Restricted-Altitude Zones. Each type of zone encompasses a radius of a certain size.
2. The radius R1 depends on the shape and size of the airport, and is an area around the airport that is a Takeoff Restricted Zone, inside of which takeoff and flight is inhibited.
3. From R1 to R1+1 miles around the airport, the flight altitude is limited on a 15 degree incline, starting at 66 feet (20 m) from the edge of airport and radiating outwards. The flight altitude is limited to 1640 feet (500 m) at R1+1 miles.
4. When the aircraft is within 320 feet (100 m) of a no-fly zone, a warning message will appear in the DJI GO app.

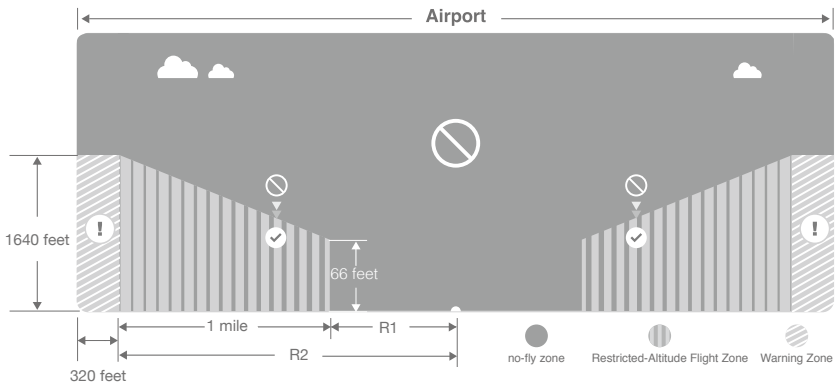





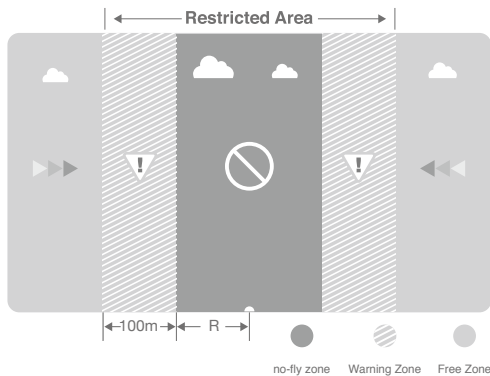

### Restricted Areas (Requires GPS):

1. Restricted Areas do not have a Restricted-Altitude Flight Zone.
2. The radius R around the designated Restricted Area is a Takeoff Restricted Area. Aircraft cannot take off within this zone. The value of R depends of the shape and size of the Restricted Area.
3. A Warning Zone is set on the perimeter of the Restricted Area. When the aircraft is within 0.062 miles (100 m) of the no-fly zone (inside the Warning Zone), a warning message will appear in the DJI GO app.



**No Fly Zone:** Areas introduced by DJI with restricted flight to help the pilot fly safely and legally.  
**no-fly zone:** The area within a No Fly Zone in which the aircraft is inhibited from any kind of flight.

Strong GPS Signal  ..... Flashing Green			
Zone	Restrictions	DJI GO App Warning	Aircraft Status Indicator
No Fly Zone 	Motors will not start.	Warning: You are in a no-fly zone. Takeoff prohibited.	 ..... Flashes red
	If the aircraft loses GPS signal and enters the restricted area but regains GPS signal afterwards, the aircraft will enter Semi-Automatic Descent and land itself.	Warning: You are in a no-fly zone. Automatic landing has begun. (If the aircraft is within R1)	
Restricted-Altitude Flight Zone 	If the aircraft loses GPS signal and enters the restricted area and regains GPS signal afterwards, it will descend to a safe altitude and hover 15 feet below the safe altitude.	Warning: You are in a restricted zone. Descending to a safe altitude. (If the aircraft is outside R1 but within R2) Warning: You are in a restricted zone. Max flight altitude restricted between 20 m and 120 m. Fly Cautiously.	
Warning Zone 	No flight restrictions.	Warning: You are approaching a Restricted Area. Fly cautiously.	
Free Zone 	No flight restrictions.	None.	

 Semi-Automatic Descent: All stick commands are available except the throttle stick command during the descent and landing process. Motors will stop automatically after landing.

-  • When flying in a No Fly Zone, the Aircraft Status Indicator will flash red rapidly and continue for 3 seconds, then switch to indicate the current flying status and continue for 5 seconds, at which point it will switch back to flashing red rapidly.
- For safety reasons, please DO NOT fly close to airports, highways, railway stations, railway lines, city centers or other busy areas. Try to ensure the aircraft is visible at all times.

## Pre-flight Checklist

1. The remote controller, Intelligent Flight Battery, and your mobile device are fully charged.
2. Propellers are mounted correctly and firmly.
3. The Micro SD card is inserted, if necessary.
4. The gimbal is functioning normally.
5. Motors start properly and are functioning as normal.
6. The DJI GO app is connected to the remote controller.

## Calibrating the Compass

**IMPORTANT:** Always calibrate the compass in every new flight location. The compass is very sensitive to electromagnetic interference, which can produce abnormal compass data and lead to poor flight performance or flight failure. Regular calibration is required for optimal performance.

Ensure the compass is calibrated. If you did not calibrate the compass as part of your pre-flight preparations, or if you have moved to a new location since the last calibration.

- 
- ⊘ • DO NOT calibrate your compass where there is any possibility of strong magnetic interference. Sources of potential interference include magnetite, parking structures, and subterranean metal structures.
  - DO NOT carry ferromagnetic materials with you during calibration such as keys or cellular phones.
  - DO NOT calibrate in direct proximity to large metal objects.
  - DO NOT calibrate indoors.
- 

### Calibration Procedures

Choose an open space to carry out the following procedures:

1. Go to the DJI GO app > Camera View > Aircraft Status Bar (top of the screen). Next to 'Compass', tap Calibrate. Alternatively, flip the S1 switch quickly for more than 3 times. The Aircraft Status Indicator will change from flashing yellow to solid yellow when the aircraft is ready for compass calibration.
2. Hold the aircraft upright and rotate it 360 degrees along the central axis. The Aircraft Status Indicator will change from solid yellow to solid green when complete.

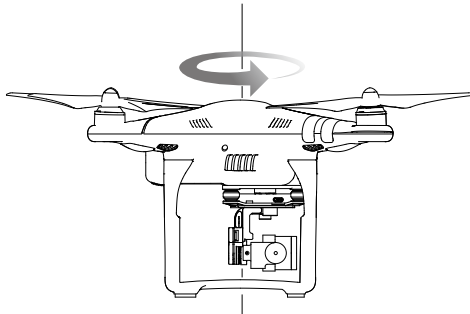

3. Hold the aircraft with its camera facing down, and rotate it 360 degrees along its central axis. The Aircraft Status Indicator will change from solid green to flashing yellow when complete. The calibration is successful.

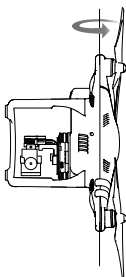

4. If the Aircraft Status Indicator becomes solid red, the calibration is unsuccessful. Repeat the steps above to recalibrate the compass.

---

 If the Aircraft Status Indicator flashes red and yellow alternatively, the compass data is abnormal. Move your aircraft to a different location to carry out the calibration.

---

 Calibrate the compass after you launch the DJI GO app if you are prompted to do so.

---

### When to Calibrate

1. The Aircraft Status Indicator is flashing red and yellow alternatively, indicating that the compass data is abnormal.
2. Flying in a new location that is different from your last flight.
3. The physical structure of the aircraft has been changed.
4. There is severe drifting during flight (i.e. the aircraft has difficulty flying in a straight line).

## Auto Takeoff and Landing

### Auto Takeoff

To use Auto Takeoff:

1. Launch the DJI GO app and enter Camera View.
2. Ensure that the aircraft is in P-Mode (switch S1 is in the uppermost position).
3. Go through the pre-flight checklist.
4. Tap  and slide Confirm to take off.
5. The aircraft will take off and hover 2.5 meters above the ground.

### Auto Landing

To use Auto Landing:

1. Ensure that the aircraft is in P-Mode (switch S1 is in the uppermost position).
2. Check that the landing area is clear before tapping  to land the aircraft.
3. The aircraft will begin to land automatically.

---

 Only use Auto Takeoff or Landing if there is a strong GPS signal.

---

## Starting and Stopping the Motors

The Combination Stick Command (CSC) illustrated below is used to start or stop the motors. Ensure you perform the CSC command in one continuous motion.

### Starting the Motors

A Combination Stick Command (CSC) is used to start the motors. Push both sticks to the bottom inner or outer corners to start the motors. Once the motors have started spinning, release both sticks simultaneously.

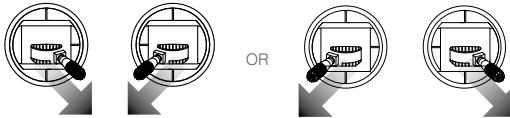

### Stopping the Motors

There are two methods to stop the motors.

**Method 1:** When the aircraft has landed, push the throttle stick down, then perform the CSC command to stop the motors. Release both sticks once the motors have stopped.

**Method 2:** When the aircraft has landed, push the throttle down and hold. The motors will stop after 3 seconds.

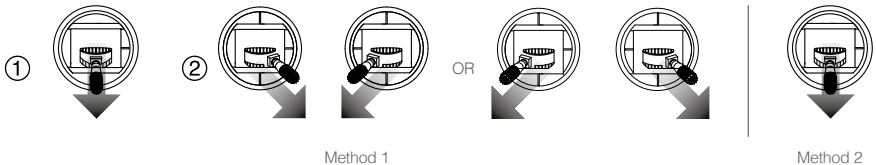

**⚠ DO NOT perform the CSC command when the aircraft is flying in mid-air.**

## Flight Test

### Takeoff and Landing Procedures

1. Place the aircraft on an open, flat ground with the battery indicator facing towards you.
2. Power on the remote controller and your mobile device, and then the Intelligent Flight Battery.
3. Launch the DJI GO app and enter Camera View.
4. Wait until the Aircraft Status Indicator flashes green. This means the Home Point has been recorded and it is safe to fly. If it flashes yellow, the Home Point has not been recorded and you must not take off.
5. Slowly push the throttle stick up or use Auto Takeoff to take off.
6. To land, hover over a level surface and gently pull down on the throttle stick to descend slowly.
7. After landing, execute the CSC command or push the throttle stick down for 3 seconds until the motors come to a stop. Do not release the control stick until the motors come to stop completely.
8. Turn off the Intelligent Flight Battery, followed by the remote controller.



- When the Aircraft Status Indicator flashes yellow rapidly during flight, the aircraft has entered the Failsafe mode.
  - The Aircraft Status Indicators will flash red slowly to indicate a Low Battery Level Warning, and flash red rapidly to indicate a Critically Low Battery Level Warning.
- 

### Tips for Shooting Aerials

1. Go through the pre-flight checklist before each flight.
2. Select the desired gimbal operation mode in the DJI GO app.
3. Shoot video when flying in P-Mode whenever possible.
4. Always fly in good weather and avoid rain or strong winds.
5. Choose a suitable recording format for the camera and adjust the settings for ISO, exposure, etc.
6. Perform test flights to establish flight routes and locate interesting scenes.
7. Move the control sticks gently to keep the aircraft's movement smooth and stable for the best shots.



## FAQ

---

In this section, we'll try our best to answer all your questions.

# FAQ

## **How far can I fly my Phantom 3 Standard?**

The signal transmission distance will vary depending on environmental conditions and local regulations, but the Phantom 3 Standard can reach distances of up to 0.62 miles (1 km) away from the pilot.

## **What is the Phantom 3 Standard's maximum flight time?**

Flight time will vary depending on environmental conditions and usage patterns, but the Intelligent Flight Battery is designed to provide up to 25 minutes of uninterrupted flight time when fully charged.

## **What app should I use with my Phantom 3 Standard?**

The Phantom 3 Standard is compatible with the DJI GO app for iOS and Android, which is also used for other DJI products. The app will detect which aircraft is connected and automatically adjust accordingly.

## **Where can I get the DJI GO app?**

The DJI GO app is free to download from the Apple App Store or Google Play. Search for "DJI GO" and download/install the app as usual.

## **Which mobile devices are compatible with the app?**

The DJI GO app is only compatible with devices running iOS 8.0 or Android v4.1.2, or later versions. A full list of suggested devices can be found on the Phantom 3 Standard webpage at "DJI.com".

## **How do I connect to the DJI GO app?**

The Phantom 3 Standard connects to the DJI GO app on your mobile device via its own WiFi network. First power on your Phantom 3 Standard and remote controller. Then connect your mobile device to the dedicated "PHANTOM3" WiFi network, and open the DJI GO app. Details can be found in the user manual.

## **How can I ensure that my pictures and videos will be synchronized to my iOS album?**

You may need to adjust the settings of your mobile device. Open the Settings menu, select the Privacy tab, select the Photos tab, and then toggle the switch next to the DJI GO app icon. If the GO app has not been granted access to your albums, the photos and videos cannot be synchronized.

## **How do I use the automatic video editor?**

There is an automatic video editor built into the DJI GO app. After recording several video clips, simply tap "Library" from the app's home screen. You can then select your clips and a template, which are automatically combined to create a short film that can be shared immediately.

## **Do I have to buy the remote controller separately?**

No, there is no need to buy a separate remote controller. Your Phantom 3 Standard comes with a custom-built remote controller that is already linked to the aircraft.

## **Does my Phantom 3 Standard support dual Remote Controllers?**

No. The included Remote Controller can be used to control both the aircraft and the gimbal tilt at the same time.

## **How do I change the control mode of my Phantom 3 Standard?**

By default, the remote controller is set to Mode 2. This means that the left stick controls the throttle and orientation of the aircraft and the right stick controls the movement of the aircraft. You can switch to other standard modes or configure a custom mode under RC Settings in the DJI GO app.

### **What do the switches on the top of the remote controller do?**

These switches are called the S1 and S2 switches.

The S1 switch allows you to change between advanced flight modes, including P-Mode, A-Mode, and F-Mode. More information about these modes can be found in the user manual. Beginners should keep this switch in the uppermost position (P-Mode) when flying.

The S2 switch can be used to trigger Return-to-Home. When flying, simply toggle this switch up and down several times to tell your Phantom 3 Standard to return to the Home Point and land.

### **Can I remove the camera and attach my own?**

No. The camera that comes with the Phantom 3 Standard is permanently attached. Attempting to remove, replace, or modify the camera may damage the product and will void your warranty.

### **Can I use a Phantom 2 Intelligent Flight Battery with the Phantom 3 Standard?**

No. The Phantom 3 series uses a newly designed Intelligent Flight Battery with greater power. The new 4-cell battery has a capacity of 4480 mAh and voltage of 15.2 V.

### **Can I use a Phantom 3 Professional/Advanced Intelligent Flight Battery with the Phantom 3 Standard?**

Yes, the Phantom 3 series batteries are the same.

### **Why is the number of discharges for the Intelligent Flight Battery not zero, even though I have never used it?**

Every Intelligent Flight Battery is tested prior to being packaged and shipped. This affects the discharge time of a new battery and is the reason that the discharge time displayed in the DJI GO app is not zero. The battery is safe to use.

### **My Phantom 3 Standard does not turn off right away, is something wrong?**

This is normal. After you release the power button, the Intelligent Flight Battery may remain on for a few seconds while any video data is saved to the Micro SD card. This helps prevent your data from being lost or corrupted.

### **How can I restore a video file if the power is turned off during recording?**

Insert the Micro SD card into the camera and turn on the Phantom 3 Standard. Wait approximately 30 seconds for the video file to be restored.

### **What should I do to land my Phantom 3 smoothly as possible?**

Hover the aircraft over a flat, level surface. Slowly pull the throttle stick down until the aircraft touches the ground.

### **How can I safely operate the aircraft when encountering compass error?**

A compass error may occur when the aircraft is flying close to strong electric magnetic sources (e.g. power lines and radio base stations). The Aircraft Status Indicators will blink red and yellow rapidly when a compass error occurs and the DJI GO app will display one of the following messages:

- **Compass error, calibration required**  
This warning message indicates the aircraft is receiving abnormal compass readings. It is recommended that you land the aircraft and recalibrate the compass at a different location. Resume flight in a different area when possible.
- **Compass error, exiting P-GPS Mode**  
This warning message indicates that the aircraft is drifting severely. Bring the aircraft to a higher altitude to acquire connections with enough GPS satellites when this warning message appears. The flight controller will automatically adjust the heading of the aircraft to mitigate the drifts. The aircraft will switch back to P-GPS mode when these adjustments are complete.

# Appendix

---

Everything else you need to know.

# Appendix

## Specifications

### Aircraft

Weight (Incl. Battery and Propellers)	1216 g
Max Ascent Speed	5 m/s
Max Descent Speed	3 m/s
Max Speed	16 m/s (A-Mode, no wind)
Max Service Ceiling Above Sea Level	6000 m (Software altitude limit: 120 m above takeoff point)
Max Flight Time	Approx. 25 min
Operating Temperature	0° to 40° C
GPS System	Built-in GPS

### Gimbal

Controllable Range	Pitch: -90° to +30°
Angular Vibration Range	±0.02°

### Camera

Sensor	1/2.3"
Photo Resolution	12 Megapixels
Lens	94° FOV, 20 mm (35 mm format equivalent) f/2.8, focus at ∞
ISO Range	100-3200 (video); 100-1600 (photo)
Electronic Shutter Speed	8 s - 1/8000 s
Max Image Size	4000 x 3000 pixels
Still Photography Modes	Single shot Photo burst mode: 3/5/7 shots Auto Exposure Bracketing (AEB): 3/5 bracketed frames at 0.7EV bias Time-lapse
Video Recording Modes	2.7K: 2704x1520p30 FHD: 1920x1080p 24/25/30 HD: 1280x720p 24/25/30/48/50/60
Max Video Bitrate	40 Mbps
Supported File Formats	FAT32/exFAT Photo: JPEG, DNG Video: MP4/MOV (MPEG-4 AVC/H.264)
Supported SD Card Types	Micro SD, Max Capacity: 64GB. Class 6 or higher
Operating Temperature	0° to 40° C
WiFi	
Operating Frequency	2.400 GHz - 2.483 GHz
Max Transmission Distance	FCC: 1000 m; CE: 500 m (outdoors and unobstructed, aircraft's altitude at 400 feet/120 m)
Transmitter Power (EIRP)	FCC: 27 dBm; CE: 20 dBm

**Remote Controller**

Operating Frequency	5.725 GHz - 5.825 GHz, 922.7 MHz - 927.7 MHz (Japan)
Max Transmission Distance	FCC: 1000 m; CE: 500 m (outdoors and unobstructed, aircraft's altitude at 400 feet/120 m)
Operating Temperature	0° to 40° C
Battery	2600 mAh LiPo 18650
Transmitter Power (EIRP)	FCC: 19 dBm; CE: 14 dBm
Operating Voltage	600 mA @ 3.7V
Charging Port	Micro USB







**Battery Charger**

Output Voltage	17.4 V
Rated Power	57 W
<b>Intelligent Flight Battery (PH3 - 4480 mAh - 15.2 V)</b>	
Capacity	4480 mAh
Voltage	15.2 V
Battery Type	LiPo 4S
Energy	68 Wh
Net Weight	365 g
Operating Temperature	-10° to - 40° C
Max Charging Power	100 W

**Aircraft Status Indicator Blinking Patterns****Normal Operations**

 ..... Flashes red, green and yellow alternately	Powered on and self-testing
 ..... Flashes green and yellow alternately	Aircraft warming up
 ..... Flashes green slowly	Safe to Fly (P-Mode with strong GPS signal)
 ..... Flashes yellow slowly	Safe to Fly (A-Mode without GPS signal)

**Warnings**

 ..... Flashes yellow quickly	Remote controller signal lost
 ..... Flashes red slowly	Low Battery Warning
 ..... Flashes red quickly	Critically Low Battery Warning
 ..... Flashes red (Alternates with other patterns)	IMU error
 — Glows solid red	Critical error
 ..... Flashes red and yellow alternately	Compass calibration required

## Firmwares Update

Connect to the Internet, launch the DJI GO app. The DJI GO app will start checking for available firmware updates automatically. Follow the on-screen instruction to update the latest firmware for the aircraft, remote controller and intelligent flight battery.

## Intelligent Flight Mode

Intelligent Flight mode includes Course Lock, Home Lock, Point of Interest (POI), Follow Me and Waypoints features to assist users to create professional shoots during the flight. Course Lock and Home Point lock helps to lock the orientation of aircraft so that the user can focus more on other operations. Point of Interest, Follow Me and Waypoints mode enable aircraft to fly automatically according to the pre-set flight maneuvers.

Course Lock	Lock the current nose direction as the aircraft's forward direction. The aircraft will move in the locked directions regardless of its orientation (yaw angle).
Home Lock	Pull the pitch stick backward to move the aircraft toward its recorded Home Point.
Point of Interest	The aircraft will orbit around the subject automatically to allow the operator can be more focus on framing their shoot on the subject in Point of Interest.
Follow Me	A virtual tether is created between the aircraft and the mobile device so that the aircraft can track your movement as you move. Note that Follow Me performance is subject to the GPS accuracy on the mobile device.
Waypoints	Record a flight path, then the aircraft will fly along the same path repeatedly while you control the camera and orientation. The flight path can be saved and re-apply in the future.

Enable Multiple Flight Mode by launching the DJI GO app > Camera View >  > Advanced Settings > Multiple Flight Mode before using the Intelligent Flight Mode for the first time.

## After-Sales Information

Visit the following pages to learn more about After-sales policy and warranty information:

1. After-sales Policy: <http://www.dji.com/service>
2. Refund Policy: <http://www.dji.com/service/refund-return>
3. Paid Repair Service: <http://www.dji.com/service/repair-service>
4. Warranty Service: <http://www.dji.com/service/warranty-service>



## FCC Compliance

### FCC Compliance

This device complies with part 15 of the FCC Rules. Operation is subject to the following two conditions:

- (1) This device may not cause harmful interference, and
- (2) This device must accept any interference received, including interference that may cause undesired operation.

Changes or modifications not expressly approved by the party responsible for compliance could void the user's authority to operate the equipment.

### Compliance Information

### FCC Warning Message

This device complies with part 15 of the FCC Rules. Operation is subject to the following two conditions: (1) This device may not cause harmful interference, and (2) this device must accept any interference received, including interference that may cause undesired operation.

### FCC Radiation Exposure Statement:

This equipment complies with FCC radiation exposure limits set forth for an uncontrolled environment. This equipment should be installed and operated with minimum distance 20cm between the radiator & your body. This transmitter must not be co-located or operating in conjunction with any other antenna or transmitter.

Note: This equipment has been tested and found to comply with the limits for a Class B digital device, pursuant to part 15 of the FCC Rules. These limits are designed to provide reasonable protection against harmful interference in a residential installation. This equipment generates uses and can radiate radio frequency energy and, if not installed and used in accordance with the instructions, may cause harmful interference to radio communications. However, there is no guarantee that interference will not occur in a particular installation. If this equipment does cause harmful interference to radio or television reception, which can be determined by turning the equipment off and on, the user is encouraged to try to correct the interference by one or more of the following measures:

- Reorient or relocate the receiving antenna.
- Increase the separation between the equipment and receiver.
- Connect the equipment into an outlet on a circuit different from that to which the receiver is connected.
- Consult the dealer or an experienced radio/TV technician for help.

### IC RSS warning

This device complies with Industry Canada licence-exempt RSS standard (s). Operation is subject to the following two conditions: (1) this device may not cause interference, and (2) this device must accept any interference, including interference that may cause undesired operation of the device.

Le présent ariel est conforme aux CNR d'Industrie Canada licables aux ariels radio exempts de licence.

L'exploitation est autorisée aux deux conditions suivantes:

- (1) l'areil ne doit pas produire de brouillage, et
- (2) l'utilisateur de l'areil doit accepter tout brouillage radioélectrique subi, même si le brouillage est susceptible d'en compromettre le fonctionnement.

### IC Radiation Exposure Statement:

This equipment complies with IC RF radiation exposure limits set forth for an uncontrolled environment. This transmitter must not be co-located or operating in conjunction with any other antenna or transmitter. This equipment should be installed and operated with minimum distance 20cm between the radiator & your body.

Any Changes or modifications not expressly approved by the party responsible for compliance could void the user's authority to operate the equipment.

### KCC Warning Message

“해당 무선설비는 운용 중 전파혼신 가능성이 있으므로 인명안전과 관련된 서비스는 할 수 없습니다.”  
“해당 무선설비는 운용 중 전파혼신 가능성이 있음”

### NCC Warning Message

低功率電波輻射性電機管理辦法

第十二條經型式認證合格之低功率射頻電機，非經許可，公司、商號或使用者均不得擅自變更頻率、加大功率或變更原設計之特性及功能。

第十四條低功率射頻電機之使用不得影響飛航安全及干擾合法通信；經發現有干擾現象時，應改善至無干擾時方得繼續使用。前項合法通信，指依電信法規定作業之無線電通信。低功率射頻電機須忍受合法通信或工業、科學及醫療用電波輻射性電機設備之干擾。



This content is subject to change.

Download the latest version from  
<http://www.dji.com/product/phantom-3-standard>

If you have any questions about this document, please contact DJI by sending a message to [DocSupport@dji.com](mailto:DocSupport@dji.com).