

PHANTOM 3

ADVANCED

User Manual V1.8

2017.07

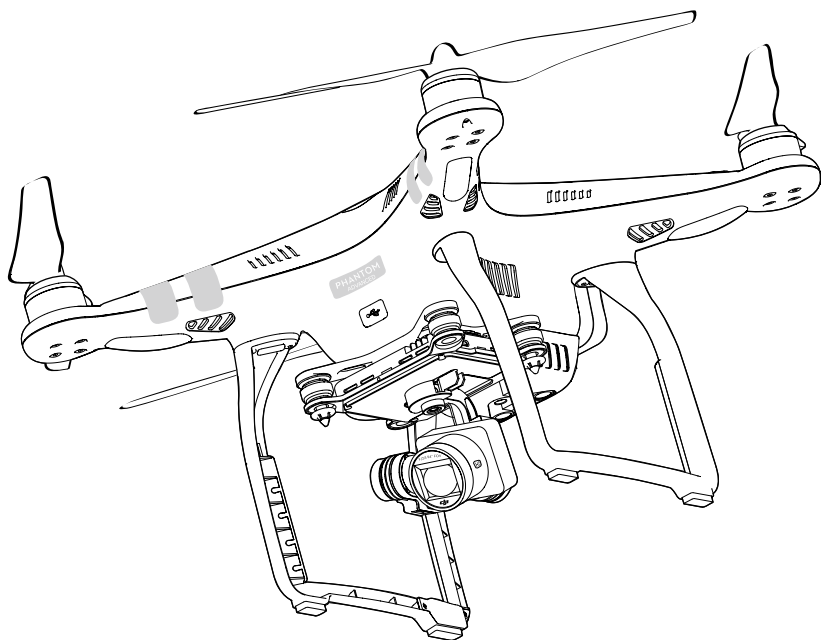

🔍 Searching for Keywords

Search for keywords such as “battery” and “install” to find a topic. If you are using Adobe Acrobat Reader to read this document, press Ctrl+F on Windows or Command+F on Mac to begin a search.

👉 Navigating to a Topic

View a complete list of topics in the table of contents. Click on a topic to navigate to that section.

Using this manual

Legends

⚠ Warning

⚠ Important

💡 Hints and Tips

📖 Reference

Read Before the First Flight

Read the following documents before using the PHANTOM™ 3 Advanced:

1. *In the Box*
2. *Phantom 3 Advanced User Manual*
3. *Phantom 3 Advanced Quick Start Guide*
4. *Phantom 3 Professional / Advanced Safety Guidelines and Disclaimer*
5. *Phantom 3 Professional / Advanced Intelligent Flight Battery Safety Guidelines*

We recommend that you watch all tutorial videos on the official DJI™ website and read the Disclaimer before you fly. Prepare for your first flight by reviewing the Phantom 3 Advanced Quick Start Guide and refer to the User Manual for more detailed information.

Video Tutorials

Please watch the tutorial videos at the link below, which demonstrates how to use Phantom 3 Advanced safely:

<http://www.dji.com/product/phantom-3/video>



Download the DJI GO app

Be sure to use the DJI GO™ app or other apps compatible with DJI aircraft during flight. Scan the QR code to the right to download the latest version.

The Android version of the DJI GO app is compatible with Android 4.1.2 or later.
The iOS version of the DJI GO app is compatible with iOS 8.0 or later.



* For increased safety, the flight is restricted to a height of 30 m and distance of 50 m when not connected or logged into the app during flight, including DJI GO and all apps compatible with DJI aircraft.

Contents

Using this manual

| | |
|------------------------------|---|
| Legends | 2 |
| Read Before the First Flight | 2 |
| Video Tutorials | 2 |
| Download the DJI GO app | 2 |

Product Profile

| | |
|---------------------------|---|
| Introduction | 6 |
| Feature Highlights | 6 |
| Preparing the Aircraft | 6 |
| Aircraft Diagram | 8 |
| Remote Controller Diagram | 8 |

Aircraft

| | |
|--|----|
| Flight Controller | 11 |
| Flight Mode | 11 |
| Flight Status Indicator | 11 |
| Return-to-Home (RTH) | 12 |
| Smart RTH | 12 |
| Low Battery RTH | 13 |
| Failsafe RTH | 14 |
| Vision Positioning System | 15 |
| Flight Recorder | 16 |
| Attaching and Detaching the Propellers | 17 |
| DJI Intelligent Flight Battery | 18 |

Remote Controller

| | |
|--------------------------------------|----|
| Remote Controller Profile | 23 |
| Using the Remote Controller | 23 |
| Remote Controller Status LED | 27 |
| Linking the Remote Controller | 28 |
| Remote Controller Compliance Version | 29 |

Camera and Gimbal

| | |
|----------------|----|
| Camera Profile | 31 |
| Gimbal | 32 |

DJI GO app

| | |
|-----------|----|
| Camera | 35 |
| Director | 38 |
| Store | 38 |
| Discovery | 38 |

Flight

| | |
|---------------------------------|----|
| Flight Environment Requirements | 40 |
| Flight Limits and No-Fly Zones | 40 |
| Preflight Checklist | 44 |
| Calibrating the Compass | 44 |
| Auto Takeoff and Auto Landing | 45 |
| Flight Test | 46 |
| Starting/Stopping the Motors | 46 |

Troubleshooting (FAQ)

Appendix

| | |
|-------------------------|----|
| Specifications | 54 |
| Firmwares Update | 56 |
| Intelligent Flight Mode | 56 |
| After-Sales Information | 56 |
| FCC Compliance | 57 |

Product Profile

This section introduces the Phantom 3 Advanced and lists the components of the aircraft and remote controller.

Product Profile

Introduction

The Phantom 3 Advanced represents the next generation of DJI quadcopters. It is capable of capturing 1080p video and transmitting an HD video signal out of the box. The built-in camera has an integrated gimbal to maximize stability while minimizing both weight and size. Even when no GPS signal is available, the Vision Positioning System allows the aircraft to hover accurately in place.

Feature Highlights

Camera and Gimbal: Phantom 3 Advanced has a fully integrated camera that shoots 1080p video at up to 60 frames per second and captures 12 megapixel photos. An enhanced sensor gives you greater clarity, lower noise, and better pictures than any previous flying camera.

HD Video Downlink: The low-latency long range HD downlink is powered by an enhanced version of DJI Lightbridge.

DJI Intelligent Flight Battery: The 4480 mAh DJI Intelligent Flight Battery features upgraded battery cells and an advanced power management system.

Flight Controller: The next-generation flight controller has been updated to provide a safer, more reliable flight experience. A newly implemented flight recorder stores critical data from each flight and the Vision Positioning System enhances hovering precision when flying indoors or in environments where GPS is unavailable.

Preparing the Aircraft

Removing Gimbal Clamp

Remove the gimbal clamp by sliding it to the right (when facing the nose of the aircraft), as shown below.

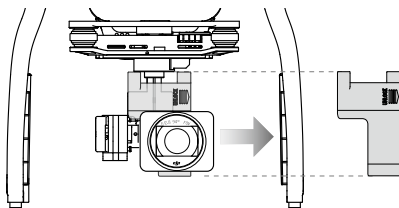

Attaching the Propellers:

Mount the propellers with black dots on to motors with black axes and spin counter-clockwise to secure. Mount the propellers with silver dots on to motors with silver axes and spin clockwise to secure. Be sure all propellers are securely in place.

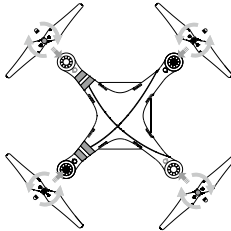

 Place all propellers onto the correct motors and tighten by hand to lock them in position.

Battery Installation

Slide battery into the battery compartment according to the arrow's direction shown below. Make sure that you hear a click sound indicates the battery is firmly installed. Failure to do so may affect the flight safety of your aircraft.

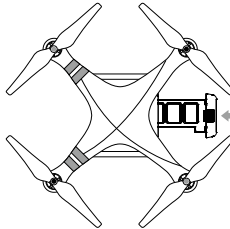

Preparing the Remote Controller:

The mobile device holder is designed for securing tablet or mobile device. Tilt the mobile device holder to the desired position, then adjust the antennas so they are facing outward.

1. Press the button on the top right side of the mobile device holder to release the clamp, then adjust the clamp to fit the size of your mobile device.
2. Secure your mobile device in the clamp by pressing down, and connect your mobile device to the remote controller using a USB cable.
3. Plug one end of the cable into the mobile device, and the other end into the USB port on the back of the remote controller.

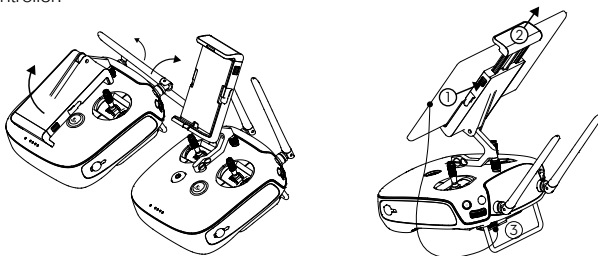

Aircraft Diagram

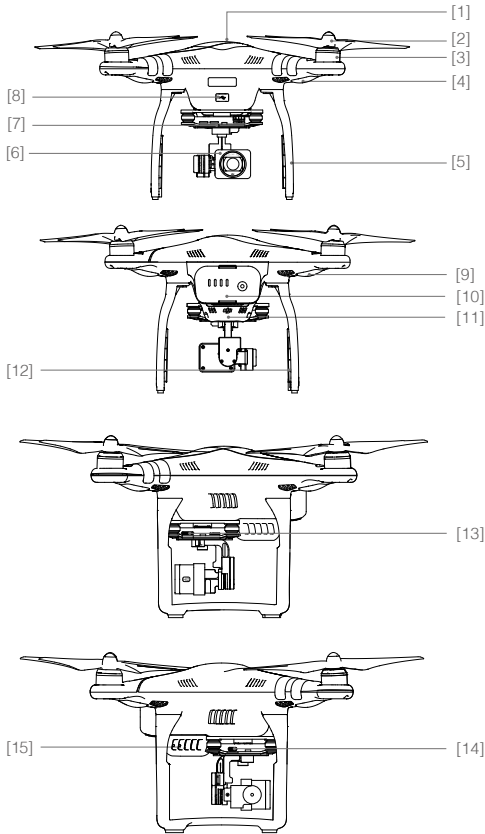

- [1] GPS
- [2] Propeller
- [3] Motor
- [4] Front LED Indicator
- [5] Landing gear
- [6] Gimbal and Camera
- [7] Camera Status Indicator
- [8] Aircraft Micro USB Port
- [9] Aircraft Status Indicator
- [10] Intelligent Flight Battery
- [11] Vision Positioning Sensors
- [12] Antennas
- [13] Camera Micro SD Card Slot
- [14] Camera Micro USB Port
- [15] Link Button

Remote Controller Diagram

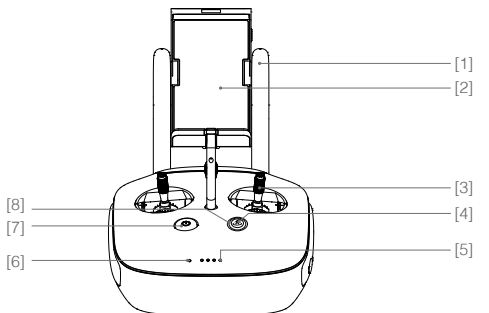

- [1] Antennas
Relays aircraft control and video signal.
- [2] Mobile Device Holder
Securely mounts your mobile device to the remote controller.
- [3] Control Stick
Controls the orientation and movement of the aircraft.
- [4] Return Home (RTH) Button
Press and hold the button to initiate Return to Home (RTH).

[5] Battery Level LEDs

Displays the battery level of the remote controller.

[6] Status LED

Displays the remote controller's system status.

[7] Power Button

Used to turn the remote controller on and off.

[8] RTH LED

Circular LED around the RTH button displays RTH status.

[9] Camera Settings Dial

Turn the dial to adjust camera settings.
(Only functions when the remote controller is connected to a mobile device running the DJI GO app.)

[10] Playback Button

Playback the captured images or videos.
(Only functions when the remote controller is connected to a mobile device running the DJI GO app.)

[11] Shutter Button

Press to take a photo. If burst mode is selected, the set number of photos will be taken with one press.

[12] Flight Mode Switch

Switch between P-mode, A-mode, and F-mode.

[13] Video Recording Button

Press to start recording video. Press again to stop recording.

[17] C1 Button

Customizable through the DJI GO app.

[18] C2 Button

Customizable through the DJI GO app.

[19] Power Port

Connect to the DJI Phantom 3 Charger to charge the battery of the remote controller.

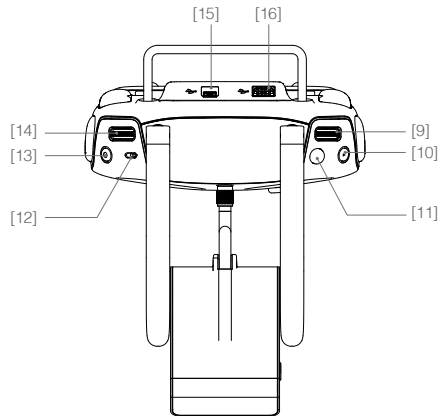
**[14] Gimbal Dial**

Use this dial to control the tilt of the gimbal.

[15] Micro USB Port

Reserved port.

[16] USB Port

Connect to mobile device or to a USB port for firmware upgrade.

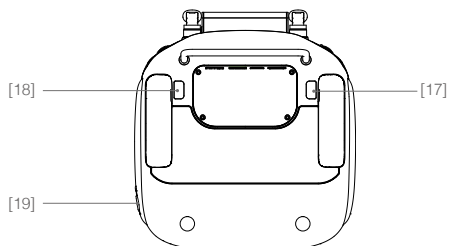

Aircraft

This section introduces the features of the Flight Controller, Vision Positioning System, and the Intelligent Flight Battery

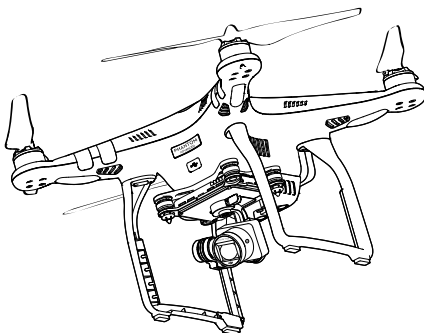

Aircraft

Flight Controller

The Phantom 3 Advanced's flight controller features several important upgrades, including a new flight mode. Safety modes include Failsafe and Return-to-Home. These features ensure the safe return of your aircraft if the control signal is lost. The flight controller can also save critical flight data from each flight to the on-board storage device. The new flight controller also provides increased stability and a new air braking feature.

Flight Mode

Three flight modes are available. The details of each flight mode are found below:

P-mode (Positioning) : P-mode works best when GPS signal is strong. There are three different states of P-mode, which will be automatically selected by the Phantom 3 Advanced depending on signal strength of GPS and Vision Positioning sensors :

P-GPS: GPS and Vision Positioning both are available. The aircraft is using GPS for positioning.

P-OPTI: Vision Positioning is available but the GPS signal strength is not sufficient. The aircraft is using only the Vision Positioning System for positioning.

P-ATTI: Neither GPS nor Vision Positioning is available. The aircraft is using only its barometer for positioning, so only altitude can be stabilized.

A-mode (Attitude): GPS and Vision Positioning System are not used for stabilization. The aircraft only uses its barometer. The aircraft can still automatically return to the home point if the control signal is lost and the Home Point was recorded successfully.

F-mode (Function): Intelligent Orientation Control (IOC) is activated in this mode. For more information about IOC, refer to the IOC section in the Appendix.



Use the Flight Controller mode switch to change the flight mode of the aircraft, refer to the ["Flight Mode Switch"](#) on Page 26 for more information.

Flight Status Indicator



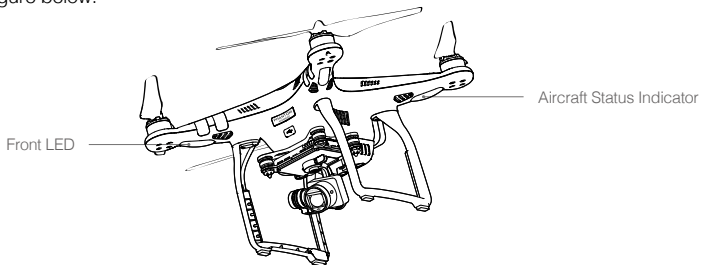

The Phantom 3 Advanced has Front LEDs and Aircraft Status Indicators. The positions of these LEDs are shown in the figure below:



The Front LEDs show the orientation of the aircraft. The Front LEDs glow solid red when the aircraft is turned on to indicate the front (or nose) of the aircraft. The Aircraft Status Indicators communicate the system status of the flight controller. Refer to the table below for more information about the Aircraft Status Indicators:

Aircraft Status Indicator Description

Normal



| | | |
|--|---|--|
|  | Red, Green and Yellow Flash Alternately | Turning On and Self Diagnostic Testing |
|  | Green and Yellow Flash Alternately | Warming Up |
|  | Green Flashes Slowly | Safe to Fly (P-mode with GPS and Vision Positioning) |
|  | Green Flashes Twice | Safe to Fly (P-mode with Vision Positioning but without GPS) |
|  | Yellow Flashes Slowly | Safe to Fly (A-mode but No GPS and Vision Positioning) |

Warning

| | | |
|--|----------------------------------|---------------------------------|
|  | Fast Yellow Flashing | Remote Controller's Signal Lost |
|  | Slow Red Flashing | Low Battery Warning |
|  | Fast Red Flashing | Critical Battery Warning |
|  | Red Flashing Alternately | IMU Error |
|  | Solid Red | Critical Error |
|  | Red and Yellow Flash Alternately | Compass Calibration Required |

Return-to-Home (RTH)

The Return-to-Home (RTH) function brings the aircraft back to the last recorded Home Point. There are three types of RTH procedures: Smart RTH, Low Battery RTH, and Failsafe RTH. This section describes these three scenarios in detail.

|  | GPS | Description |
|--|---|--|
| Home Point |  | If a strong GPS signal was acquired before takeoff, the Home Point is the location from which the aircraft was launched. The GPS signal strength is indicated by the GPS icon (). The aircraft status indicator will blink rapidly when the home point is recorded. |

Smart RTH

Use the RTH button on the remote controller (refer to "RTH button" on page 26 for more information) or tap the RTH button in the DJI GO app and follow the on-screen instructions when GPS is available to initiate Smart RTH. The aircraft will then automatically return to the last recorded Home Point. You may use the remote controller's control sticks to control the aircraft's position to avoid a collision during the Smart RTH process. Press and hold the Smart RTH button once to start the process, and press the Smart RTH button again to terminate the procedure and regain full control of the aircraft.

Low Battery RTH

The low battery level failsafe is triggered when the DJI Intelligent Flight Battery is depleted to a point that may affect the safe return of the aircraft. Users are advised to return home or land the aircraft immediately when prompted. The DJI GO app will display a notice when a low battery warning is triggered. The aircraft will automatically return to the Home Point if no action is taken after a ten-second countdown. The user can cancel the RTH procedure by pressing the RTH button on the remote controller. The thresholds for these warnings are automatically determined based on the aircraft's current altitude and distance from the Home Point.

The aircraft will land automatically if the current battery level can only support the aircraft long enough to descend from its current altitude. The user can still use the remote controller to alter the aircraft's orientation during the landing process.

The Battery Level Indicator is displayed in the DJI GO app, and is described below:

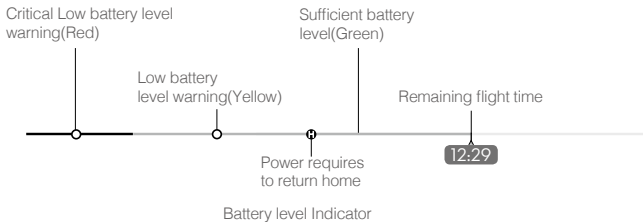

| Battery Level Warning | Remark | Aircraft Status Indicator | DJI GO app | Flight Instructions |
|------------------------------------|--|---|---|--|
| Low battery level warning | The battery power is low. Please land the aircraft. | Aircraft status indicator blinks RED slowly. | Tap "Go-home" to have the aircraft return to the Home point and land automatically, or "Cancel" to resume normal flight. If no action is taken, the aircraft will automatically go home and land after 10 seconds. Remote controller will sound an alarm. | Fly the aircraft back and land it as soon as possible, then stop the motors and replace the battery. |
| Critical Low battery level warning | The aircraft must land immediately. | Aircraft status indicator blinks RED quickly. | The DJI GO app display will flash red and the aircraft will start to descend. The remote controller will sound an alarm. | Allow the aircraft to descend and land automatically. |
| Estimated remaining flight time | Estimated remaining flight based on current battery level. | N/A | N/A | N/A |

- When the Critical battery level warning is triggered and the aircraft begins to land automatically, you may push the throttle upward to make the aircraft hover at its current altitude, giving you an opportunity to navigate to a more appropriate landing location.
- The colored zones and markers on the battery level indicator bar reflect the estimated remaining flight time. They are automatically adjusted according to the aircraft's current location and status.

Failsafe RTH

If the Home Point was successfully recorded and the compass is functioning normally, Failsafe RTH will be automatically activated if the remote controller signal is lost for more than three seconds. The Return-to-Home process may be interrupted and the operator may regain control of the aircraft if the remote controller signal connection is re-established.

Failsafe Illustration

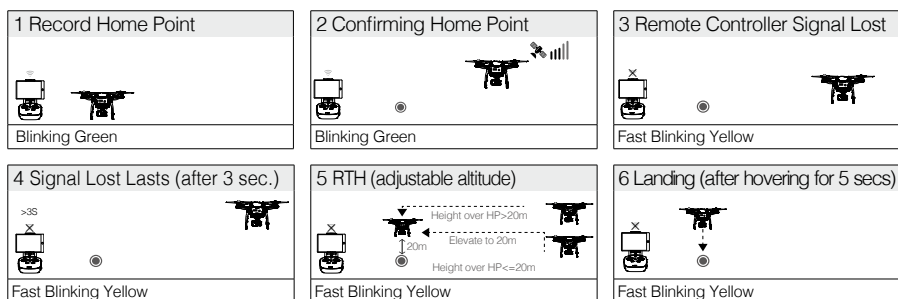





- Aircraft cannot return to the Home Point when GPS signal is weak ([] displays grey) or unavailable.
- Aircraft automatically descends and lands if RTH is triggered when the aircraft flies within a 20 meters (65 feet) radius of the Home Point. Aircraft will stop ascending and immediately return to the Home Point if you move the throttle stick if the aircraft reaches 20 meters (65 feet) altitudes or beyond during Failsafe.
- The aircraft cannot avoid obstruction during the Failsafe RTH, therefore, it is important to set an suitable Failsafe altitude before each flight. Launch the DJI GO app and enter "Camera" and select "MODE > Advanced Settings > Failsafe mode" to set the Failsafe altitude.
- User cannot control the aircraft while the aircraft is ascending to its failsafe altitude. However, user can press RTH button once to exit ascending and regain control.

Failsafe Safety Notices



The aircraft cannot avoid obstruction during the Failsafe RTH, therefore, it is important to set an suitable Failsafe altitude before each flight. Launch the DJI GO app and enter "Camera" and select "MODE > Advanced Settings > Failsafe mode" to set the Failsafe altitude.

| | |
|---|--|
|  | <p>If the aircraft is flying under 20 meters (65 feet) and Failsafe (including Smart RTH, Lower Battery RTH) is triggered, the aircraft will first automatically ascend to 20 meters (65 feet) from the current altitude. You can only cancel the ascending by exiting the Failsafe. Refer to "RTH Button" on page 26 for more information on how to exit the Failsafe and regain the control of the remote controller.</p> |
|  | <p>Aircraft automatically descends and lands if RTH is triggered when the aircraft flies within a 20 meters (65 feet) radius of the Home Point. Aircraft will stop ascending and immediately return to the Home Point if you move the throttle stick if the aircraft reaches 20 meters (65 feet) altitudes or beyond during Failsafe.</p> |
|  | <p>Aircraft cannot return to the Home Point when GPS signal is weak ([📶] displays grey) or unavailable.</p> |
|  | <p>if you move the throttle stick after the aircraft rises above 65 feet (20m) but below the pre-set Failsafe RTH altitude, the aircraft will stop ascending and immediately return to the Home Point.</p> |

Vision Positioning System

The DJI Vision Positioning System uses ultrasound and image data to help the aircraft maintain its current position. With the help of Vision Positioning, your Phantom 3 Advanced can hover in place more precisely and fly indoors or in other environments where a GPS signal is not available. The main components of the Vision Positioning System are located on the bottom of your Phantom 3 Advanced; they include [2] two ultrasonic sensors and [1] one monocular camera.

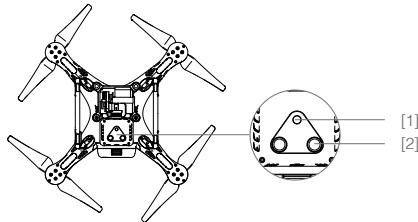

Using Vision Positioning

Vision Positioning is activated automatically when the Phantom 3 Advanced is turned on. No further action is required. Vision Positioning is typically used in indoor environments, where GPS is unavailable. Using the sensors that are built into the Vision Positioning system, the Phantom 3 Advanced can hover precisely even without GPS.

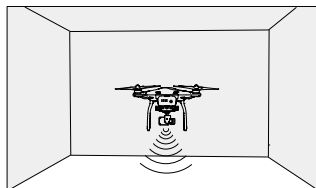

Follow the steps below to use Vision Positioning:

1. Toggle the flight mode switch to P-mode.
2. Place the aircraft on a flat surface. Note that the Vision Positioning system cannot work properly on surfaces without clear pattern variations.
3. Turn on the aircraft. The aircraft status indicator will flash green two times, which indicates the Vision Positioning system is ready. Gently push the throttle up to lift off and the aircraft will hover in place.

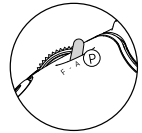

⚠ The performance of your Vision Positioning System is affected by the surface over which it is flying. The ultrasonic sensors may not be able to accurately measure distances when operating above sound-absorbing materials. In addition, the camera may not function correctly in suboptimal environments. The aircraft will switch from P-mode to A-mode automatically if neither GPS nor Vision Positioning System are available. Operate the aircraft with great caution in the following situations:

- Flying over monochrome surfaces (e.g. pure black, pure white, pure red, pure green).
- Flying over a highly reflective surfaces.
- Flying at high speeds(over 8 m/s at 2 meters or over 4 m/s at 1 meter).
- Flying over water or transparent surfaces.
- Flying over moving surfaces or objects.
- Flying in an area where the lighting changes frequently or drastically.
- Flying over extremely dark (lux < 10) or bright (lux > 100,000) surfaces.
- Flying over surfaces that can absorb sound waves (e.g. thick carpet).
- Flying over surfaces without clear patterns or texture.
- Flying over surfaces with identical repeating patterns or textures (e.g. tiles with the same design).
- Flying over inclined surfaces that will deflect sound waves away from the aircraft.

- 🚫**
- Keep the sensors clean at all times. Dirt or other debris may adversely affect the effectiveness of the sensors.
 - Vision Positioning is only effective when the aircraft is at altitudes of 0.3 to 3 meters.
 - The Vision Positioning System may not function properly when the aircraft is flying over water.
 - The Vision Positioning System may not be able to recognize pattern on the ground in low light conditions (less than 100 lux).
 - Do not use other ultrasonic devices with frequency of 40 KHz when Vision Positioning system is in operation.
 - Vision Positioning System may not be able to stabilize the aircraft when flying close to the ground (below 0.5 meters) at fast speeds..





- 🚫**
- Keep animals away from the aircraft when Vision Positioning system is activated. The sonar sensor emits high frequency sounds that are only audible to some animals.

Flight Recorder

Flight data is automatically recorded to the internal storage of the aircraft. This includes flight telemetry, aircraft status information, and other parameters. To access these data, connect the aircraft to the PC through the Micro USB port and launch the DJI GO app.

Attaching and Detaching the Propellers

Use only DJI approved propellers with your Phantom 3 Advanced. The grey and black nuts on the propeller indicate where they should be attached and in which direction they should spin. To attach the propellers properly, match the nut color with the motor axis color.

| Propellers | Silver Dot | Black Dot |
|------------|--|---|
| Figure |  |  |
| Attach On | Motors with a grey axes | Motors with a black axes |
| Legends |  Lock : Turn the propellers in the indicated direction to mount and tighten.  Unlock : Turn the propellers in the indicated direction to loosen and remove. | |

Attaching the Propellers

1. Be sure to remove the warning stickers from the motors before attaching the propellers.
2. Attach the propellers with silver dots onto the motors with silver axes and spin the propellers clockwise to secure them in place. Attach the propellers with black dots onto the motors with black axes and spin the propellers counter-clockwise to secure them in place. Be sure to tighten each propeller by hand before flight.

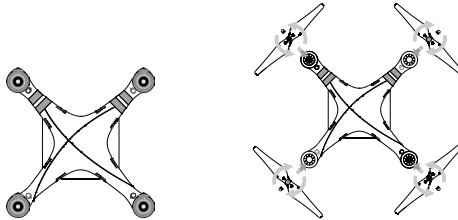

-  • Ensure the propellers are attached to the correct motors. Only using the propeller with the same model.
- Tighten the propellers with both hands before each flight.
- Ensure that all propellers are in good condition before each flight. DO NOT use aged, chipped, or broken propellers.
- Stand clear of the motors and DO NOT touch the propellers when they are spinning.

Detaching the Propellers

Hold the motor in place with one hand, then spin the propeller in the indicated unlock direction.

-  • Check that the propellers and motors are installed correctly and firmly before every flight.
- Ensure that all propellers are in good condition before each flight. DO NOT use aged, chipped, or broken propellers.
- To avoid injury, STAND CLEAR of and DO NOT touch propellers or motors when they are spinning.
- ONLY use original DJI propellers for a better and safer flight experience.

DJI Intelligent Flight Battery

The DJI Intelligent Flight Battery has a capacity of 4480 mAh, a voltage of 15.2 V, and a smart charge/discharge functionality. It should only be charged using an appropriate charger that has been approved by DJI.

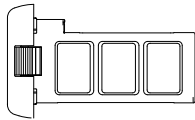

Intelligent Flight Battery

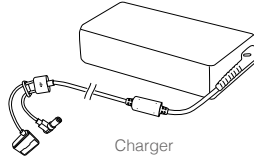

Charger

⚠ The Intelligent Flight Battery must be fully charged before using it for the first time. Refer to [“Charging the Intelligent Flight Battery”](#) for more information.

⚡ Be aware that the output power of the supplied Phantom 3 Advanced charger is 57 W.

DJI Intelligent Flight Battery Functions

1. Battery Level Display: the LED indicators display the current battery level.
2. Battery Life Display: the LEDs display the current battery power cycle.
3. Auto-Discharging Function: To prevent swelling, the battery automatically discharges to below 65% of total power when it is idle for more than ten days. It takes around two days to discharge the battery to 65%. It is normal to feel moderate heat being emitted from the battery during the discharge process. Discharge thresholds can be set in the DJI GO app.
4. Balanced Charging: Automatically balances the voltage of each battery cell when charging.
5. Overcharge Protection: Charging automatically stops when the battery is fully charged.
6. Temperature Detection: The battery will only charge when the temperature is between 0°C (32°F) and 40°C (104°F).
7. Over Current Protection: The battery stops charging when high amperage (more than 8 A) is detected.
8. Over Discharge Protection: To prevent over-discharge damage, discharging automatically stops when the battery voltage reaches 12 V.
9. Short Circuit Protection: Automatically cuts the power supply when a short circuit is detected.
10. Battery Cell Damage Protection: The DJI GO app displays a warning message when a damaged battery cell is detected.
11. Battery Error History: Browse the battery error history in the DJI GO app.
12. Sleep mode: To save power, the battery enters sleep mode after 20 minutes of inactivity.
13. Communication: Information pertaining to the battery's voltage, capacity, current, etc. is transmitted to the aircraft's main controller.

⚠ Refer to *Phantom 3 Professional / Advanced Intelligent Flight Battery Safety Guidelines* before use. Users take full responsibility for all operations and usage.

Using the Battery

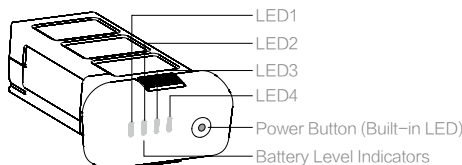

Turning ON/OFF

Turning On: Press the Power Button once, then press again and hold for 2 seconds to turn on. The Power LED will turn red and the Battery Level Indicators will display the current battery level.

Turning Off: Press the Power Button once, then press again and hold for 2 seconds to turn off. The battery power LED will flash when powering off the Phantom to allow automatically stopping of a recording during the event recording wasn't stopped.

Low Temperature Notice:

1. Battery capacity is significantly reduced when flying in low temperature ($< 0^{\circ}\text{C}$) environments.
2. It is not recommended that the battery be used in extremely low temperature ($< -10^{\circ}\text{C}$) environments. Battery voltage should reach the appropriate level when operating environment with temperatures between -10°C and 5°C .
3. End the flight as soon as the DJI GO app displays the "Low Battery Level Warning" in low temperature environments.
4. Keep the battery indoors to warm it before flying in low temperature environments.
5. To ensure optimal performance of the battery, keep the battery temperature above 20°C .
6. The charger will stop charging the battery if the battery cell's temperature is not within the operating range ($0^{\circ}\text{C} \sim 40^{\circ}\text{C}$).





































 In cold environments, insert the battery into the battery compartment and allow the aircraft for approximately 1-2 minutes to warm up before taking off.

Checking the Battery Level

The Battery Level Indicators display how much power remains. When the battery is turned off, press the Power Button once. The Battery Level Indicators will light up to display the current battery level. See below for details.

 The Battery Level Indicators will also show the current battery level during charging and discharging. The indicators are defined below.

 : LED is on.  : LED is flashing.
 : LED is off.

| Battery Level | | | | |
|---|---|---|---|---------------|
| LED1 | LED2 | LED3 | LED4 | Battery Level |
|  |  |  |  | 87.5%~100% |
|  |  |  |  | 75%~87.5% |
|  |  |  |  | 62.5%~75% |
|  |  |  |  | 50%~62.5% |
|  |  |  |  | 37.5%~50% |
|  |  |  |  | 25%~37.5% |
|  |  |  |  | 12.5%~25% |
|  |  |  |  | 0%~12.5% |
|  |  |  |  | =0% |

Battery life

Battery life refers to how many more times the battery can be discharged and recharged before it must be replaced. When the battery is turned off, press and hold the Power Button for 5 seconds to check the battery life. The Battery Level Indicators will light up and/or blink for two seconds, as shown below:

| Battery Life | | | | |
|--------------|------|------|------|--------------|
| LED1 | LED2 | LED3 | LED4 | Battery Life |
| □ | □ | □ | □ | 90%~100% |
| □ | □ | □ | ▤ | 80%~90% |
| □ | □ | □ | □ | 70%~80% |
| □ | □ | ▤ | □ | 60%~70% |
| □ | □ | □ | □ | 50%~60% |
| □ | ▤ | □ | □ | 40%~50% |
| □ | □ | □ | □ | 30%~40% |
| ▤ | □ | □ | □ | 20%~30% |
| □ | □ | □ | □ | below 20% |

⚠ When battery life reaches 0%, it can no longer be used.

📖 For more information about the battery, launch the DJI GO app and check the information that is listed under the battery tab.

Charging the Intelligent Flight Battery

1. Connect the Battery Charger to a power source (100-240 V 50/60 Hz).
2. Open the Protection Cap and connect the Intelligent Flight Battery to the Battery Charger. If the battery level is above 95%, turn on the battery before charging.
3. The Battery Level Indicator will display the current battery level as it is charging.
4. The Intelligent Flight Battery is fully charged when the Battery Level Indicators are all off.
5. Air-cool the Intelligent Flight Battery after each flight. Allow its temperature to drop to room temperature before storing it for an extended period.

⚠ • Always turn off the battery before inserting it or removing it from the Phantom 3 Advanced. Never insert or remove a battery when it is turned on.

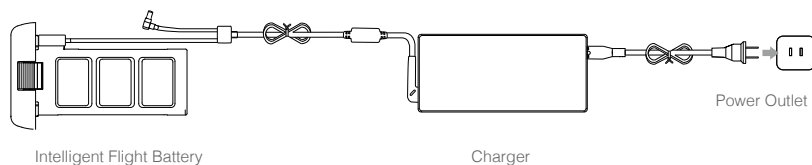

Battery Level Indicators While Charging

| LED1 | LED2 | LED3 | LED4 | Battery Level |
|------|------|------|------|---------------|
| | | | | 0%~25% |
| | | | | 25%~50% |
| | | | | 50%~75% |
| | | | | 75%~100% |
| | | | | Fully Charged |

Battery Protection LED Display

The table below shows battery protection mechanisms and corresponding LED patterns.

Battery Level Indicators while Charging

| LED1 | LED2 | LED3 | LED4 | Blinking Pattern | Battery Protection Item |
|------|------|------|------|------------------------------------|----------------------------------|
| | | | | LED2 blinks twice per second | Over current detected |
| | | | | LED2 blinks three times per second | Short circuit detected |
| | | | | LED3 blinks twice per second | Over charge detected |
| | | | | LED3 blinks three times per second | Over-voltage charger detected |
| | | | | LED4 blinks twice per second | Charging temperature is too low |
| | | | | LED4 blinks three times per second | Charging temperature is too high |

After these issues are resolved, press the Power Button to turn off the Battery Level Indicator. Unplug the Intelligent Flight Battery from the charger and plug it back in to resume charging. Note that you do not need to unplug and plug in the charger in the event of a room temperature error; the charger will resume charging when the temperature is within the allowable range.



DJI does not take any responsibility for damage caused by third-party chargers.

**How to discharge your Intelligent Flight Battery:**

Slow : Place the Intelligent Flight Battery into the Phantom 3 Advanced's Battery Compartment and turn it on. Leave it on until there is less than 8% of power left, or until the battery can no longer be turned on. Launch the DJI GO app to check battery levels.

Rapid : Fly the Phantom 3 Advanced outdoors until there is less than 8% of power left, or until the battery can no longer be turned on.

Remote Controller

This section describes the features of the remote controller and includes instructions for controlling the aircraft and the camera.

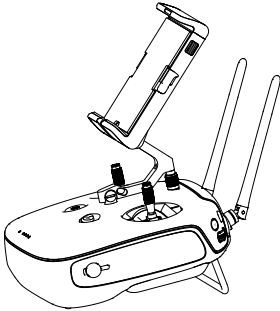

Remote Controller

Remote Controller Profile

The Phantom 3 Advanced remote controller is a multi-function wireless communication device that integrates the video downlink system and aircraft remote control system. The video downlink and aircraft remote control system operate at 2.4 GHz. The remote controller features a number of camera control functions, such as taking and previewing photos and videos, as well as controlling gimbal motion. The remote controller is powered by a 2S rechargeable battery. The battery level is displayed via LED indicators on the front panel of the remote controller.



- **Compliance Version:** The remote controller is compliant with both CE and FCC regulations.
- **Operating Mode:** Control can be set to Mode 1 or Mode 2, or to a custom mode.
- **Mode 1:** The right stick serves as the throttle.
- **Mode 2:** The left stick serves as the throttle.



To prevent transmission interference, do not operate more than three aircrafts in the same area.

Using the Remote Controller

Turning the Remote Controller On and Off

The Phantom 3 Advanced remote controller is powered by a 2S rechargeable battery that has a capacity of 6000 mAh. The battery level is indicated via the Battery Level LEDs on the front panel. Follow the steps below to turn on your remote controller:

1. When the remote controller is turned off, press the Power Button once. The Battery Level LEDs will display the current battery level.
2. Press and hold the Power Button to turn on the remote controller.
3. The remote controller will beep when it is turned on. The Status LED will rapidly blink green, indicating that the remote controller is linking to the aircraft. The Status LEDs will glow solid green when linking is complete.
4. Repeat Step 2 to turn off the remote controller.

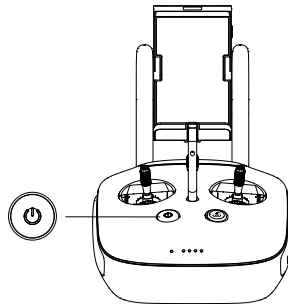

Charging the Remote Controller

Charge the remote controller using the included charger. Refer to the figure on next page below for more details.

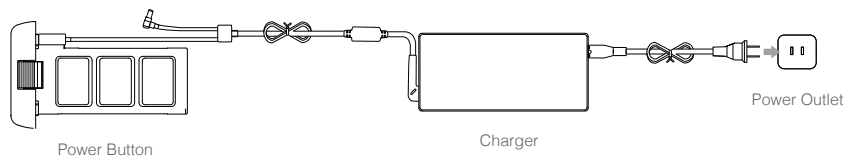

Controlling the Camera

Shoot videos/pictures, view recorded images, and adjust camera settings via the Shutter Button, Camera Settings Dial, Playback Button, and Video Recording Button on the remote controller.

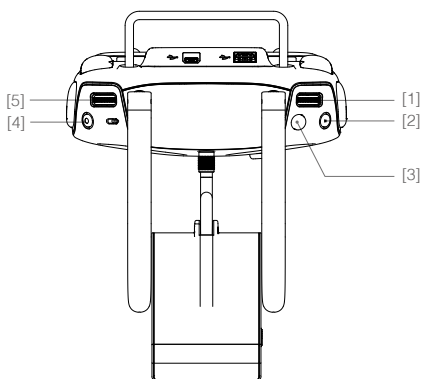

[1] Camera Settings Dial

Turn the dial to adjust camera settings such as ISO, shutter speed, and aperture without letting go of the remote controller. Move the dial to left or right to scroll through pictures and videos in playback mode. Press down on the dial to toggle between these settings.

[2] Playback Button

Press to view images and videos that have already been captured.

[3] Shutter Button

Press to take a photo. If burst mode is activated, multiple photos will be taken with a single press.

[4] Video Recording Button

Press once to start recording video, then press again to stop recording.

[5] Gimbal Dial







Use this dial to control the tilt of the gimbal.

Controlling Aircraft

This section explains how to control the orientation of the aircraft through the remote controller. The Remote Control is set to Mode 2 by default.

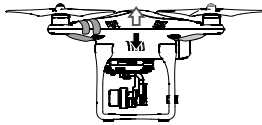
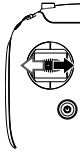
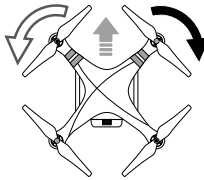
 Stick Neutral/Mid-Point: Control sticks are in the center position.

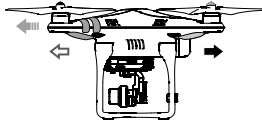
Moving the Control Stick: The control stick is pushed away from the center position.

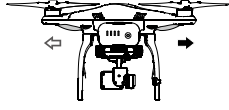
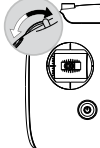
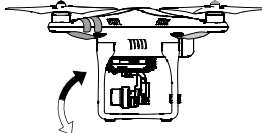
| Remote Controller (Mode 2) | Aircraft ( Indicates Nose Direction) | Remarks |
|---|---|--|
|  |  | <p>Moving the left stick up and down changes the aircraft's elevation.</p> <p>Push the stick up to ascend and down to descend. When both sticks are centered, the Phantom 3 Advanced will hover in place.</p> <p>The more the stick is pushed away from the center position, the faster the Phantom 3 Advanced will change elevation. Always push the stick gently to prevent sudden and unexpected elevation changes.</p> |
|  |  | <p>Moving the left stick to the left or right controls the rudder and rotation of the aircraft.</p> <p>Push the sick left to rotate the aircraft counter-clockwise, push the stick right to rotate the aircraft clockwise. If the stick is centered, the Phantom 3 Advanced will maintain its current orientation.</p> <p>The more the stick is pushed away from the center position, the faster the Phantom 3 Advanced will rotate.</p> |
|  |  | <p>Moving the right stick up and down changes the aircraft's forward and backward pitch.</p> <p>Push the stick up to fly forward and down to fly backward. Phantom 3 Advanced will hover in place if the stick is centered.</p> <p>Push the stick further away from the center position for a larger pitch angle (maximum 30°) and faster flight.</p> |
|  |  | <p>Moving the right stick control left and right changes the aircraft's left and right pitch.</p> <p>Push left to fly left and right to fly right. The Phantom 3 Advanced will hover in place if the stick is centered.</p> |
|  |  | <p>Gimbal Dial: Turn the dial to the right, and the camera will shift to point upwards. Turn the dial to the left, and the camera will shift to point downwards. The camera will remain in its current position when dial is static.</p> |

Adjusting Controller Sticks

Hold and twist the controller sticks clockwise or counter clockwise to adjust the length of the controller sticks. A proper length of controller sticks can improve the controlling accuracy.

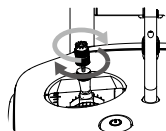

Flight Mode Switch

Toggle the switch to select the desired flight mode. You may choose between; P-mode, F-mode and A-mode.

| Position | Figure | Flight Mode |
|------------|--------|-------------|
| Position 1 | | F-mode |
| Position 2 | | A-mode |
| Position 3 | | P-mode |

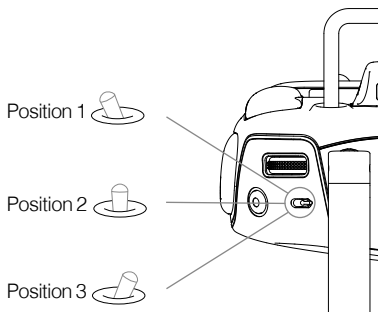

P-mode (Positioning): P-mode works best when the GPS signal is strong. There are three different versions of P-mode, which will be automatically selected by the Phantom 3 Advanced depending on GPS signal strength and the Vision Positioning sensors:

- P-GPS: GPS and Vision Positioning both are available; the aircraft is using GPS for positioning.
- P-OPTI: Vision Positioning is available but a sufficient GPS signal is not available. Aircraft is using only Vision Positioning for position holding.
- P-ATTI: Neither GPS nor Vision Positioning is available, the aircraft is using only its barometer for positioning, so only altitude is maintained.

A-mode (Attitude): GPS and Vision Positioning System are not used for stabilization. The aircraft uses only its barometer to stabilize. The aircraft can automatically return to the Home Point if remote controller signal is lost and the Home Point was recorded successfully.

F-mode (Function): Intelligent Orientation Control (IOC) is activated in this mode. For more information about IOC, refer to the IOC section in the Appendix.

By default, the Flight Mode Switch is locked to P-mode. To unlock other flight modes, launch the DJI GO app, enter the "Camera" page, and tap "Mode", then activate "Multiple Flight Mode".

RTH Button

Press and hold the RTH button to start the Return-to-Home (RTH) procedure. The LED ring around the RTH Button will blink white to indicate that the aircraft is entering RTH mode. The aircraft will then return to the last recorded Home Point. Press this button again to cancel the RTH procedure and regain control of the aircraft.

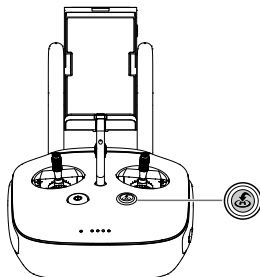

Connecting Your Mobile Device

Tilt the mobile device holder to the desired position. Press the button on the side of the mobile device holder to release the clamp, and then place your mobile device into the cradle. Adjust the clamp down to secure the mobile device. To connect your mobile device to the remote controller using a USB cable, plug one end of the cable into your mobile device and the other end into the USB port on the back of the remote controller.

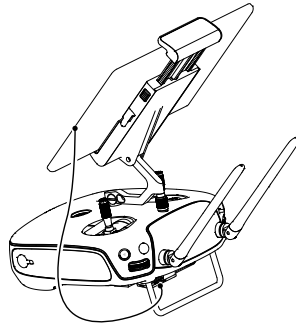

Optimal Transmission Range

The transmission signal between the aircraft and the remote controller is most reliable within the area that is depicted in the image below:

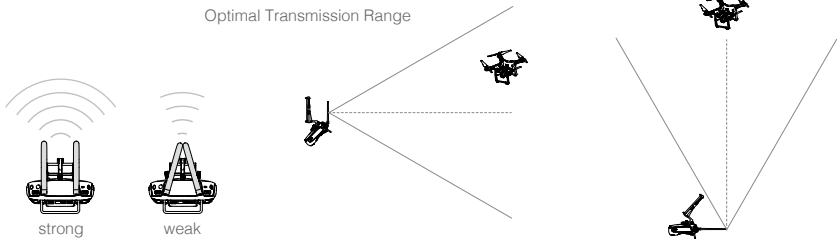

Ensure that the aircraft is flying within the optimal transmission zone. To achieve the best transmission performance, maintain the appropriate relationship between the operator and the aircraft.

Remote Controller Status LED

The Status LED reflects the strength of the connection between the remote controller and the aircraft. The RTH LED indicates the Return-to-Home status of the aircraft. The table below contains more information about these indicators.

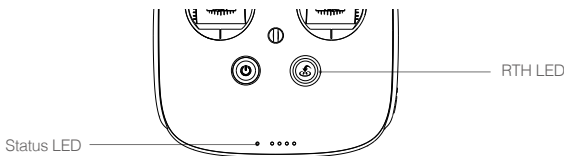

| Status LED | Alarm | Remote Controller Status |
|--|------------|--|
| — Solid Red | Chime | The remote controller is disconnected from the aircraft. |
| — Solid Green | Chime | The remote controller is connected to the aircraft. |
| Slow Blinking Red | D-D-D..... | Remote controller error. |
| / Red and Green/ Red and Yellow Alternate Blinks | None | HD downlink is disrupted. |
| RTH LED | Sound | Remote Controller Status |
| — Solid White | Chime | Aircraft is returning home. |
| Blinking White | D . . . | Sending Return-to-Home command to the aircraft. |
| Blinking White | DD | Return-to-Home procedure in progress. |

The Remote Status Indicator will blink red and sound an alert, when the battery level is critically low.

Linking the Remote Controller

The remote controller is linked to your aircraft before delivery. Linking is only required when using a new remote controller for the first time. Follow these steps to link a new remote controller:

1. Turn on the remote controller and connect to the mobile device. Launch the DJI GO app.
2. Turn on the Intelligent Flight Battery.
3. Enter “Camera” and tap on and then tap “Linking RC” button as shown below.

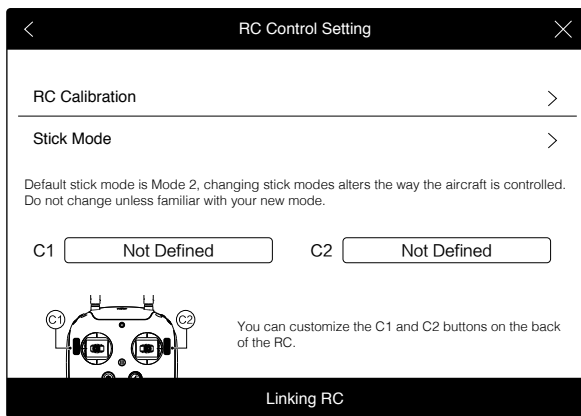

4. The remote controller is ready to link. The Remote Controller Status Indicator blinks blue and a beep is emitted.

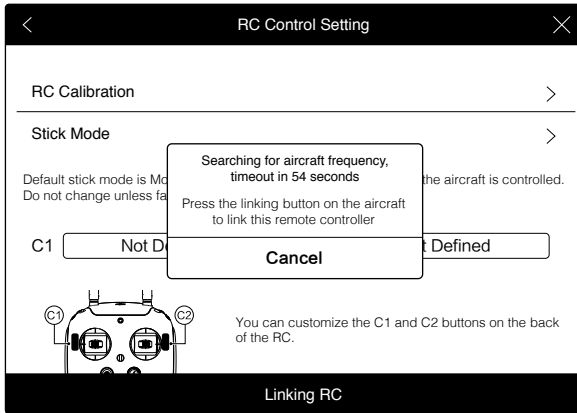

5. Locate the linking button on the side of the aircraft, as shown in the figure below. Press the link button to start linking. The Remote Controller Status Indicator LED will display a solid green once the remote controller is successfully linked to the aircraft.

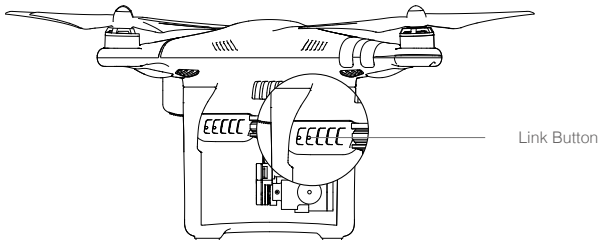

- The remote controller will un-link itself from an aircraft if a new remote controller is linked to the same aircraft.

Remote Controller Compliance Version

The remote controller is compliant with both CE and FCC requirements.

Camera and Gimbal

This section provides the technical specifications of the camera and explains the gimbal's operation modes.

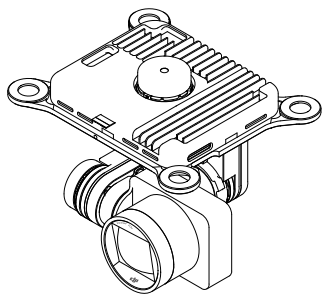

Camera and Gimbal

Camera Profile

The on-board camera uses a 1/2.3 inch CMOS sensor to capture video (up to 1080p at 60 frames per second with the Phantom 3 Advanced) and 12 megapixel stills. You may choose to record the video in either MOV or MP4 format. Available picture shooting modes include burst, continuous, and time-lapse mode. A live preview of what the camera sees can be monitored on the connected mobile device via the DJI GO app.

Camera Micro SD Card Slot

To store your photos and videos, insert the Micro SD card into the slot, as shown below, before turning on the Phantom 3 Advanced. The Phantom 3 Advanced comes with a 16 GB Micro SD card and supports Micro SD cards up to 64 GB. A UHS-1 Micro SD card is recommended due to their fast read and write speeds allowing you to save high-resolution video data.

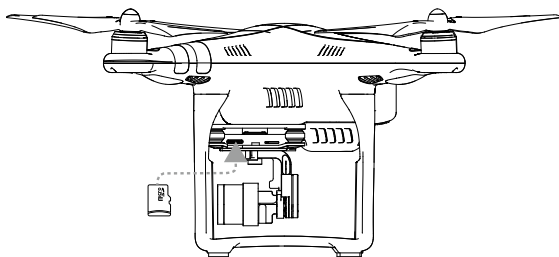

⊘ Do not remove the Micro SD card from the Phantom 3 Advanced when it is turned on.

Camera Data Port

Turn on the Phantom 3 Advanced and connect a USB cable to the Camera Data Port to download photos and videos to your computer.

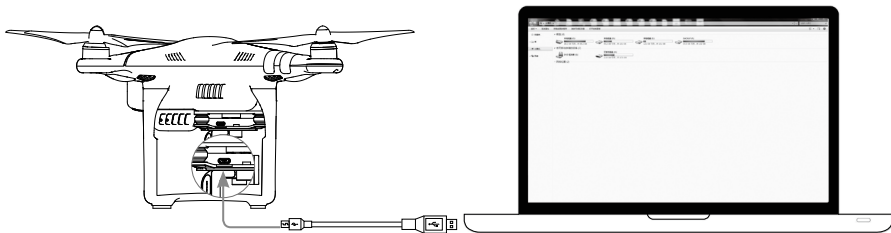









⚠ The aircraft must be turned on before attempting to access the files on the Micro SD card.

Camera Operation

Use the Shutter and Video Recording buttons on the remote controller to shoot the images or videos through the DJI GO app. For more information about how to use these buttons, refer to "[Controlling the Camera Page 24](#)".

Camera LED Indicator

Camera LED Indicator lights up after the flight battery is powered on. It provides information on the working status of the camera.

| Camera LED Indicator | Camera status |
|--|--------------------------------|
|  Green Fast Blink (0.2s off, 0.1s on) | System is warming up. |
|  Green Blink Once (0.5s off, 0.4s on) | Taking a single picture. |
|  Green Blink 3 Times (0.3s off, 0.1s on) | Taking 3 or 5 photos per shot. |
|  Slow Red Blink (1.6s on, 0.8s off) | Recording. |
|  Fast Red Blink (0.5s off, 0.2s on) | SD card error. |
|  Double Red Blink (0.1s on, 0.1s off, 0.1s on, 0.1s off) | Overheated Camera |
|  Solid Red | System error. |
|  Green and Red Blink (0.8s green on, 0.8s red on) | Firmware Upgrading |

Gimbal

Gimbal Profile

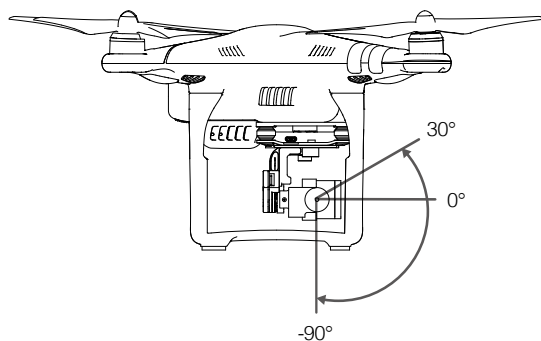

The 3-axis gimbal provides a steady platform for the attached camera, allowing you to capture clear, stable images and video. The gimbal can tilt the camera within a 120° range.



Use the gimbal dial on the remote controller to control the tilt movement of the camera.

Gimbal Operation Modes

Two gimbal operation modes are available. Switch between the different operation modes on the camera settings page of the DJI GO app. Note that your mobile device must be connected to the remote controller for changes to take effect. Refer to the table below for details:

| | | |
|--|--|---|
|  |  <p>Follow Mode</p> | <p>The angle between gimbal's orientation and aircraft's nose remains constant at all times.</p> |
| |  <p>FPV Mode</p> | <p>The gimbal will synchronize with the movement of the aircraft to provide a first-person perspective flying experience.</p> |



- A gimbal motor error may occur in these situations: (1) the aircraft is placed on uneven ground or the gimbal's motion is obstructed (2) the gimbal has been subjected to an excessive external force, such as a collision. Please take off from flat, open ground and protect the gimbal at all times.
- Flying in heavy fog or clouds may make the gimbal wet, leading to temporary failure. The gimbal will recover full functionality after it dries.

Anti-Drop Kit

The anti-drop kit helps keep the gimbal and camera connected to the aircraft. Two pins have been mounted prior to shipping. If new or additional pins are required, see the diagram below. Press Part ① through the hole of the vibration absorber and into the center hole of Part ②, then lock them together as shown ③. Mounting the anti-drop kit pins diagonally from each other is recommended.

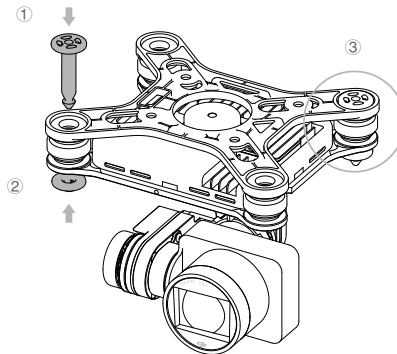

DJI GO app

This section introduces the four main functions of the DJI GO app.

DJI GO app

The DJI GO app is a mobile application designed specifically for the Phantom 3 Advanced. Use this app to control the gimbal, camera, and other aircraft functions. The app also features Map, Academy, and User Center, which are used for configuring your aircraft and sharing your photos and videos with others. It is recommended that you use a tablet for the best experience.

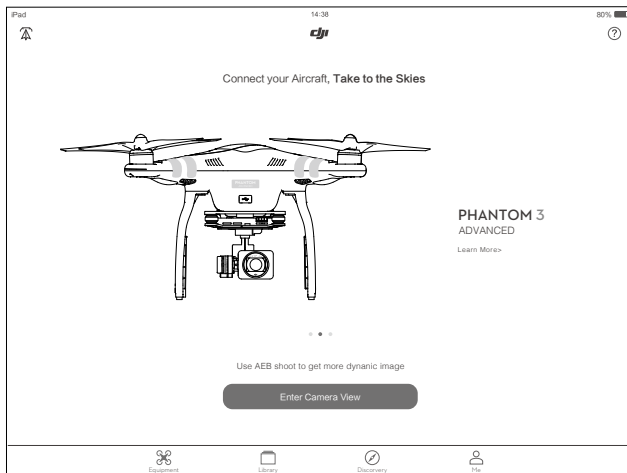

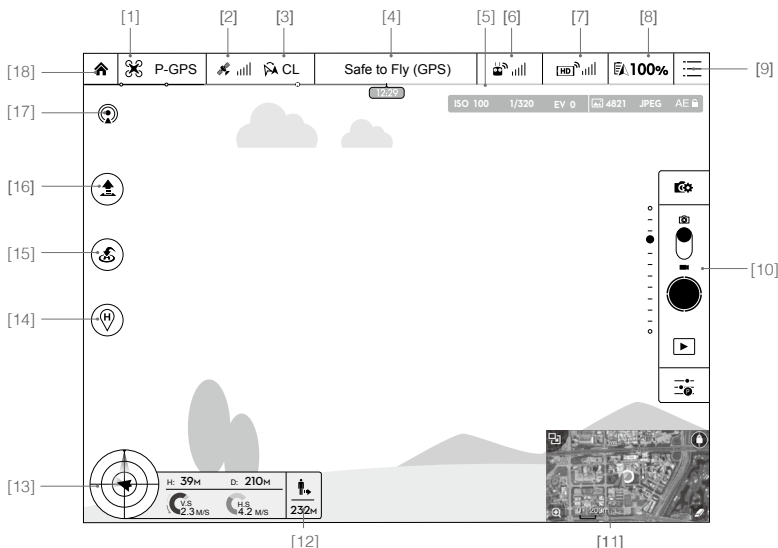

Camera

The Camera page contains a live HD video feed from the Phantom 3 Advanced's camera. You can also configure various camera parameters from the Camera page.



[1] Flight Mode

: The text next to this icon indicates the current flight mode. Tap to configure the MC (Main Controller) Settings. These settings allow you to modify flight limits and set the gain values.

: The aircraft is set to "Beginner Mode" by default. The aircraft cannot fly 30 meters (98 feet) higher and beyond the recorded Home Point under beginner mode. Disable this mode in the MODE setting page.

[2] GPS Signal Strength

: This icon shows the current strength of GPS signals. Green bars indicate adequate GPS strength.

[3] IOC Settings

 **CL**: This icon displays the IOC setting when the aircraft has entered F-mode. Tap to view the IOC settings menu and select the desired IOC setting.

[4] System Status

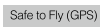
 **Safe to Fly (GPS)**: This icon indicates the current aircraft system status and GPS signal strength.

[5] Battery Level Indicator

: The battery level indicator provides a dynamic display of the battery level. The colored zones on the battery level indicator represent the power levels needed to carry out different functions.

[6] Remote Controller Signal

: This icon shows the strength of remote controller's signal.

[7] HD Video Link Signal Strength

: This icon shows the strength of the HD video downlink connection between the aircraft and the remote controller.

[8] Battery Level

 **100%**: This icon shows the current battery level.

Tap to view the battery information menu, set the various battery warning thresholds, and view the battery warning history.

[9] General Settings

: Tap this icon to view the General Settings page. From this page, you can set flight parameters, reset the camera, enable the quick view feature, adjust the gimbal roll value, and toggle the flight route display.

[10] Camera Operation Bar

Shutter and Recording Settings

: Tap to enter various camera value settings, including color space for the recording, resolution of the videos, image size and so on.

Shutter

 : Tap this button to take a single photo. Press and hold this button to select single shot, triple shot or time-lapsed shooting modes.

Record

 : Tap once to start recording video, then tap again to stop recording. You can also press the Video Recording Button on the remote controller, which has the same functionality.

Playback

 : Tap to enter the playback page. You can preview photos and videos as soon as they are captured.



Camera Settings

 : Tap to set ISO, shutter and auto exposure values of the camera.

[11] Map

Display the flight path of the current flight. Tap to switch from the Camera GUI to the Map GUI.

**[12] Vision Positioning**

 : The distance of the aircraft from the Home Point. When the aircraft is near the ground, this icon will change to  to display the height the Vision Position System's sensors from the ground.

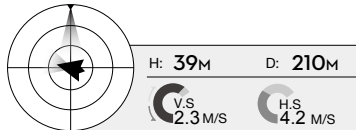
[13] Flight Telemetry

The Vision Positioning Status icon is highlighted when the Vision Positioning is in operation.

Flight attitude is indicated by the flight attitude icon.

- (1) The red arrow shows which direction the aircraft is facing.
- (2) Light blue and dark blue areas indicate pitch.
- (3) The angle of the boundary between the light blue and dark blue areas indicates the roll angle.

[14] Dynamic Home Point

 : Press this button to enable the dynamic home point feature, the home point then will be reset to position of the mobile device.

[15] Return to Home (RTH)

 : Initiate RTH home procedure. Tap to have the aircraft return to the last recorded home point.

[16] Auto Takeoff/Landing

 : Tap to initiate auto takeoff or landing.

[17] Livestream

 : Livestream icon indicates the current video feed is broadcasting live on YouTube. Be sure the mobile data service is available on the mobile device.

[18] Back

 : Tap to return to the main GUI.

Director

Director is an automatic video editor built into the DJI GO app. After recording several video clips, simply tap "Director" from the app's home screen. You can then select a template and a specified number of clips, which are automatically combined to create a short film that can be shared immediately.

Store

Tap "Store" to visit the official DJI Online Store to see the latest information about DJI products and easily buy new products.

Discovery

Sync pictures and videos to your mobile device, view flight logs, and check your DJI account status in "Discovery". Use your registered DJI account to login to "Discovery".

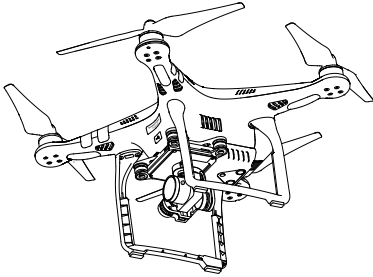

Flight

This section describes safe flight practices and flight restrictions.

Flight

Once pre-flight preparation is complete, it is recommended that you use the flight simulator in the DJI GO app to hone your flight skills and practice flying safely. Ensure that all flights are carried out in an open area.

Flight Environment Requirements

1. Do not use the aircraft in severe weather conditions. These include wind speeds exceeding 10 m/s , snow, rain and fog.
2. Only fly in open areas. Tall structures and large metal structures may affect the accuracy of the on-board compass and GPS system.
3. Avoid obstacles, crowds, high voltage power lines, trees, and bodies of water.
4. Minimize interference by avoiding areas with high levels of electromagnetism, including base stations and radio transmission towers.
5. Aircraft and battery performance is subject to environmental factors such as air density and temperature. Be very careful when flying at altitudes greater than 19, 685 feet (6000 meters) above sea level, as the performance of the battery and aircraft may be affected.
6. The Phantom 3 Advanced cannot operate within the polar areas.

Flight Limits and No-Fly Zones

All unmanned aerial vehicle (UAV) operators should abide by all regulations set forth by government and regulatory agencies including the ICAO and the FAA. For safety reasons, flights are limited by default, which helps users operate this product safely and legally. Flight limitations include height limits, distance limits, and No-Fly Zones.

When operating in P-mode, height limits, distance limits, and No-Fly Zones function concurrently to manage flight safety. In A-mode, only height limits are in effect, which by default prevent the aircraft altitude from exceeding 1640 feet (500 m) .

Maximum flight altitude & Radius Limits

Maximum flight altitude and radius limits may be changed in the DJI GO app. Be aware that the maximum flight altitude cannot exceed 1640 feet (500 meters). In accordance with these settings, your Phantom 3 Advanced will fly in a restricted cylinder, as shown below:

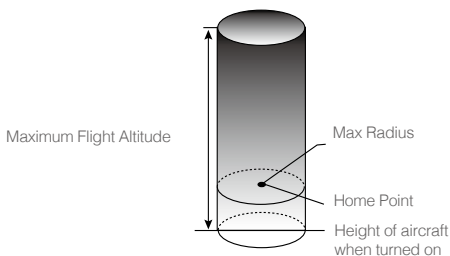

GPS Signal Strong Blinking Green

| | Flight Limits | DJI GO app | Aircraft Status Indicator |
|-------------------------|--|----------------------------------|--|
| Maximum Flight Altitude | Aircraft's altitude cannot exceed the specified value. | Warning: Height limit reached. | None. |
| Max Radius | Flight distance must be within the max radius. | Warning: Distance limit reached. | Rapid red flashing  when close to the max radius limit. |

GPS Signal Weak Blinking Yellow

| | Flight Limits | DJI GO app | Aircraft Status Indicator |
|-------------------------|--|--------------------------------|---------------------------|
| Maximum Flight Altitude | Height is restricted to 26 feet (8 meters) when the GPS signal is weak and Vision Positioning is activated. Height is restricted to 164 feet (50 meters) when the GPS signal is weak and Vision Positioning is inactivated. | Warning: Height limit reached. | None. |
| Max Radius | No limits | | |

-  If you fly out of the limit, you can still control the Phantom 3, but cannot fly it any farther. If the Phantom 3 flies out of the max radius in Ready to Fly (non-GPS) mode, it will fly back within range automatically.
- If the Phantom 3 flies out of the max radius in Ready to Fly (non-GPS) mode, it will fly back within range automatically.

No-Fly Zones

All No-Fly Zones are listed on the DJI official website at <http://flysafe.dji.com/no-fly>. No-Fly Zones are divided into Airports and Restricted Areas. Airports include major airports and flying fields where manned aircraft operate at low altitudes. Restricted Areas include border lines between countries or sensitive institute. The details of the No-Fly Zones are explained as follow:

Airport

- Airport No-Fly Zone are comprised of Take-off Restricted zones and Restricted Altitude Zones. Each zone features circles of various sizes.
- R1 miles (value of the R1 depends on the size and shape of the airport) around the airport is a Take-off restricted zone, inside of which take off is prevented.
- From R1 mile to R1 + 1 mile around the airport the flight altitude is limited to a 15 degree inclination. Starting at 65 feet (20 meters) from the edge of airport and radiating outward. The flight altitude is limited to 1640 feet (500 meters) at R1+1 mile
- When the aircraft enters within 320 feet (100 meters) of No-Fly Zones, a warning message will appear on the DJI GO app.

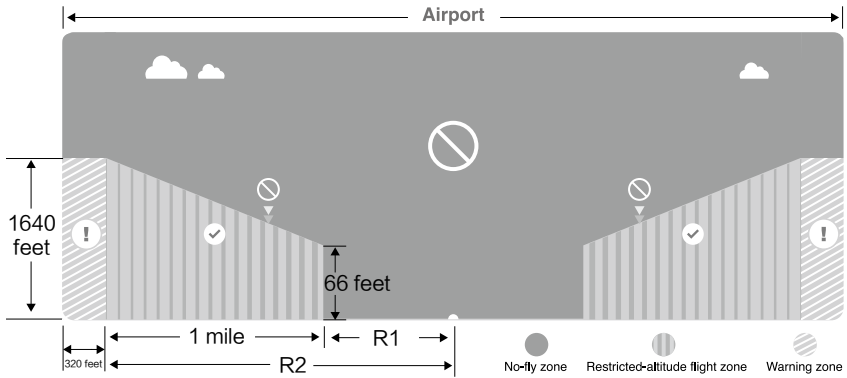





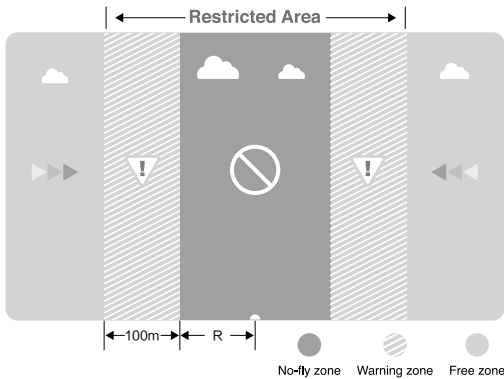

Restricted Area

- (1) Restricted Areas does not have flight altitude restrictions.
- (2) R miles around the designated restriction area is a Take-off Restricted area. Aircraft cannot take off within this zone. The value of R varies based on the definition of the restricted areas.
- (3) A "warning zone" has been set around the Restricted Area. When the aircraft approaches within 0.062 miles (100 m) of this zone, a warning message will appear on the DJI GO app.



Flight

| GPS Signal Strong  Blinking Green | | | |
|--|---|--|---|
| Zone | Restriction | DJI GO app Prompt | Aircraft Status Indicator |
| No-fly Zone  | Motors will not start. | Warning: You are in a No-fly zone. Take off prohibited. |  Red flashing |
| | If the aircraft enters the restricted area in A-mode, but is switched to P-mode, the aircraft will automatically descend, land, and stop its motors. | Warning: You are in a no-fly zone. Automatic landing has begun. | |
| Restricted-altitude flight zone  | If the aircraft enters the restricted area in A-mode, but is switched to P-mode, it will descend to an appropriate altitude and hover 15 feet below the altitude limit. | R1: Warning: You are in a restricted zone. Descending to safe altitude. R2: Warning: You are in a restricted zone. Maximum flight altitude is restricted to between 20m and 500m. Fly cautiously. | |
| Warning zone  | No flight restriction applies, but there will be a warning . | Warning: You are approaching a restricted zone, Fly cautiously. | |
| Free zone  | No restrictions. | None. | |

 Semi-automatic descent: All stick commands are available except the throttle stick command during the descent and landing process. Motors will stop automatically after landing.

-  • When flying in a safety zone, the aircraft's status indicator will blink red rapidly and continue for 3 seconds, then switch to indicate current flying status and continue for 5 seconds at which point it will switch back to blinking red.
- For safety reasons, please do not fly close to airports, highways, railway stations, railway lines, city centers, or other sensitive areas. Fly the aircraft only within your line of sight.

Preflight Checklist

1. Remote controller, Intelligent Flight Battery, and mobile device are fully charged.
2. Propellers are mounted correctly and firmly.
3. Micro SD card has been inserted, if necessary.
4. Gimbal is functioning normally.
5. Motors can start and are functioning normally.
6. The DJI GO app is successfully connected to the aircraft.

Calibrating the Compass

Only calibrate the compass when the DJI GO app or the status indicator prompt you to do so. Observe the following rules when calibrating your compass:

- DO NOT calibrate your compass where there is a chance of strong magnetic interference, such as magnetite, parking structures, and steel reinforcements underground.
- DO NOT carry ferromagnetic materials with you during calibration such as cellular phones.
- The DJI GO app will prompt you to resolve the compass issue if the compass is affected by strong interference after calibration is complete. Follow the prompted instructions to resolve the compass issue.

Calibration Procedures

Choose an open area to carry out the following procedures.

1. Ensure that the compass is calibrated. If you did not calibrate the compass as part of your pre-flight preparations, or if you have moved to a new location since the last calibration, tap the Aircraft Status Bar in the app and select "Calibrate", then follow the on-screen instructions.
2. Hold the aircraft horizontally and rotate 360 degrees. The Aircraft Status Indicators will display a solid green light.

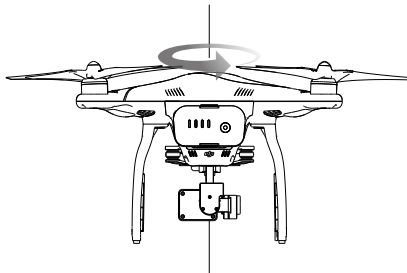

- Hold the aircraft vertically, with nose pointing downward, and rotate it 360 degrees around the center axis. Recalibrate the compass if the Aircraft Status Indicator glows solid red.

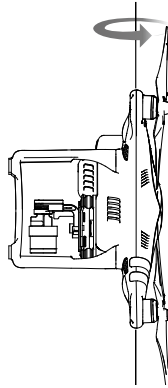

⚠ If the Aircraft Status Indicator blinks red and yellow after the calibration procedure, move your aircraft to a different location and try again.

☀ Launch the DJI GO app and follow the on-screen instructions to calibrate the compass. DO NOT calibrate the compass near metal objects such as a metal bridge, cars, scaffolding.

When to Recalibrate

- When compass data is abnormal and the Aircraft Status Indicator is blinking green and yellow.
- When flying in a new location or in a location that is different from the most recent flight.
- When the mechanical or physical structure of the Phantom 3 Advanced has been changed.
- When severe drifting occurs in flight, i.e. Phantom 3 Advanced does not fly in straight line.

Auto Takeoff and Auto Landing

Auto Takeoff

Use auto takeoff only if the Aircraft Status Indicators are blinking green. Follow the steps below to use the auto takeoff feature:

- Launch the DJI GO app, and enter "Camera" page.
- Ensure the aircraft is in P- mode.
- Complete all steps on the pre-flight checklist.
- Tap "▲", and confirm that conditions are safe for flight. Slide the icon to confirm and takeoff.
- Aircraft takes off and hovers at (1.2 meters) above ground.

⚠ Aircraft Status Indicator blinks rapidly when it is using the Vision Position System for stabilization. The aircraft will automatically hover below 3 meters. It is recommended to wait until there is sufficient GPS lock before using the Auto Take-off feature.

Auto-Landing

Use auto-landing only if the Aircraft Status Indicators are blinking green. Follow the steps below to use the auto-landing feature:

1. Ensure the aircraft is in P- mode.
2. Check the landing area condition before tapping “”, to begin landing. Then follow the on-screen instructions.

Starting/Stopping the Motors

Starting the Motors

A Combination Stick Command (CSC) is used to start the motors. Push both sticks to the bottom inner or outer corners to start the motors. Once the motors have started spinning, release both sticks simultaneously.

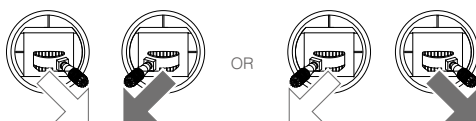

Stopping the Motors

There are two methods to stop the motors.

Method 1: When Phantom 3 Advanced has landed, push the throttle down, then conduct the same CSC that was used to start the motors, as described above. Motors will stop immediately. Release both sticks once motors stop.

Method 2: When the aircraft has landed, push and hold the throttle down. The motors will stop after three seconds.

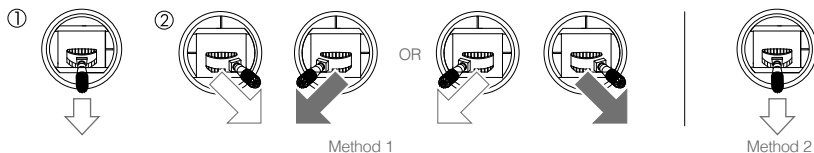

 Do not perform a CSC when the aircraft is in midair, otherwise the motors will suddenly stop.

Flight Test

Takeoff/Landing Procedures

1. Place the aircraft in an open, flat area with the battery level indicators facing towards you.
2. Turn on the remote controller and your mobile device, then turn on the Intelligent Flight Battery.
3. Launch the DJI GO app and enter the Camera page.
4. Wait until the Aircraft Indicators blink green. This means the Home Point is recorded and it is now safe to fly. If they flash yellow, the Home Point has not been recorded.
5. Push the throttle up slowly to take off or use Auto Takeoff.
6. Shoot photos and videos using the DJI GO app.
7. To land, hover over a level surface and gently pull down on the throttle to descend.
8. After landing, execute the CSC command or hold the throttle at its lowest position until the motors stop.
9. Turn off the Intelligent Flight Battery first, then the Remote Controller.



- When the Aircraft Status Indicators blink yellow rapidly during flight, the aircraft has entered Failsafe mode.
 - A low battery level warning is indicated by the Aircraft Status Indicators blinking red slowly or rapidly during flight.
 - Watch our video tutorials for more flight information.
-

Video Suggestions and Tips

1. Go through the full pre-flight checklist before each flight.
2. Select the desired gimbal operation mode in the DJI GO app.
3. Only shoot video when flying in P-mode.
4. Always fly in good weather and avoid flying in rain or heavy wind.
5. Choose the camera settings that suit your needs. Settings include photo format and exposure compensation.
6. Perform flight tests to establish flight routes and preview scenes.
7. Push the control sticks gently to keep the aircraft's movement smooth and stable.

FAQ

Troubleshooting (FAQ)

What is the difference between the Phantom 3 Professional and the Phantom 3 Advanced?

The biggest difference between the Phantom 3 Professional and the Phantom 3 Advanced is in the camera. The Phantom 3 Professional is capable of shooting spectacular 4K video at up to 30 frames per second, and the Phantom 3 Advanced is capable of shooting at resolutions up to 1080p60. Both models shoot 12 megapixel photos.

The other main difference is the Intelligent Flight Battery charger. The Phantom 3 Advanced comes with a 57-watt charging unit and the Phantom 3 Professional comes with a 100-watt charger, the latter of which allows for shorter charging times.

Can I remove the camera and attach my own?

No. The cameras that come with both models are permanently attached. Attempting to remove, replace, or modify the camera may damage the product and will void your warranty.

Can I charge my Remote Controller and Intelligent Flight Battery at the same time?

While the Remote Controller charger and Intelligent Flight Battery charger have been integrated into one unit for your convenience, it is recommended that you only charge one item at a time. We recommend that you never charge both items using the same charger at the same time.

What are the buttons on the back of my Remote Controller for?

The two buttons on the back of the Remote Controller can be customized and assigned to function as you choose through the DJI GO app. Refer to the manual for more information.

How far can I fly my Phantom 3?

The signal transmission distance will vary depending on environmental conditions, but the Phantom 3 series can reach distances of up to 3.1 miles (5 kilometers) away from the pilot.

What app should I use with my Phantom 3?

The Phantom 3 is compatible with the DJI GO app for iOS and Android, which is already used with the DJI Inspire. The app will detect which aircraft is connected and automatically adjust accordingly.

Which mobile devices are compatible with the app?

The DJI GO app is only compatible with devices running iOS 8.0 or later or Android v4.1.2 or later.

The following devices are recommended:

iOS: iPhone 5s, iPhone 6, iPhone 6 Plus, iPad Air, iPad Air Wi-Fi + Cellular, iPad mini 2, iPad mini 2 Wi-Fi + Cellular, iPad Air 2, iPad Air 2 Wi-Fi + Cellular, iPad mini 3, and iPad mini 3 Wi-Fi + Cellular. This app is optimized for iPhone 5s, iPhone 6, and iPhone 6 Plus

Android: Samsung S5, Note 3, Sony Z3 EXPERIA, Google Nexus 7 II, Google Nexus 9, Mi 3, Nubia Z7 mini
Support for additional Android devices will become available as testing and development continues.

How do I use the Director automatic video editor?

Director is an automatic video editor built into the DJI GO app. After recording several video clips, simply tap "Director" from the app's home screen. You can then select a template and a specified number of clips, which are automatically combined to create a short film that can be shared immediately.

How do I change the control mode of my Phantom 3?

By default, the Remote Controller is set to Mode 2. This means that the right control stick controls the movement of the aircraft and the left control stick controls the throttle and orientation of the aircraft. These controls can be changed to Mode 1 or set to a customized configuration in the DJI GO app. This is only recommended for advanced users.

Can I use a Phantom 2 Remote Controller with the Phantom 3?

No. The Phantom 2 Remote Controller operates on a different frequency. The Phantom 2 Remote Controller operates at 5.8 GHz and the new Phantom 3 Remote Controller operates at 2.4 GHz.

Can I use a Phantom 2 Intelligent Flight Battery with the Phantom 3?

No. The Phantom 3 uses a newly designed Intelligent Flight Battery with greater power. The Phantom 3 has a 4 cell battery with a capacity of 4480 mAh and a voltage of 15.2 V.

My Phantom 3 does not turn off right away, is something wrong?

This is normal. After you attempt to power off the Intelligent Flight Battery, it may remain on for a few seconds as any video data is saved to the Micro SD card. This helps prevent your data from being lost or corrupted.

Do I have to buy the Remote Controller separately?

No, there is no need to buy a separate Remote Controller. Your Phantom 3 comes with a Remote Controller that is already linked to the aircraft.

Does my Phantom 3 support dual Remote Controllers?

No. The included Remote Controller can be used to control both the aircraft and the gimbal tilt at the same time.

What does the "P, A, F" switch on the Remote Controller do?

This switch, called the Flight Mode Switch, allows you to toggle different flight modes:

P-mode, or Positioning mode, indicates that both GPS and the Vision Positioning System are active and your Phantom 3 will attempt to stabilize using both.

In A-mode, or Attitude mode, the aircraft does not use GPS or the Vision Positioning System. Only the barometer is used for stabilization. The aircraft can still return to the Home Point as long as a sufficient GPS signal is available.

F-mode, or Function mode, activates Intelligent Orientation Control (IOC) functionality. Refer to the IOC section in the Appendix of the User Manual.

By default, only P-mode may be used. Refer to your user manual for instructions on unlocking the other modes.

What is the Phantom 3 flight time?

Flight times will vary depending on environmental conditions and usage patterns, but the Intelligent Flight Battery is designed to provide up to 23 minutes of uninterrupted flight time when fully charged.

How can I restore a video file if the power is turned off during recording?

Do not remove the Micro SD card from the camera. If it has been removed, place it back in the camera. Turn the Phantom 3 on and wait approximately 30 seconds as the video file is restored.

How can I ensure that my pictures and videos will be synchronized to my iOS album?

You may need to adjust the settings of your mobile device. Open the Settings menu, select the Privacy tab, select the Photos tab, and then toggle the switch next to the DJI GO app icon. If the GO app has not been granted access to your albums, the photos and videos cannot be synchronized.

What should I do to land my Phantom 3 smoothly as possible?

Hover the aircraft over a flat, level surface. Slowly pull the throttle stick down until the aircraft touches the ground.

Why is the discharge time of the battery not zero, even though I have never used it?

Every battery is tested prior to being packaged and shipped. This affects the discharge time of a new battery and is the reason that the discharge time is not zero. The battery is safe to use.

Can the mobile device holder be used on the Phantom 2 series Remote Controller?

No, it cannot.

How to safely operate the aircraft when encountering compass error?

A compass error may occur when the aircraft is flying close to strong electric magnetic sources (e.g. power transmission lines). Aircraft Status Indicators blink red and yellow rapidly when a compass error occurs and the DJI GO app will display one of the following messages:

- Compass error, calibration required

This warning message indicates the aircraft is receiving abnormal compass readings. It is recommended to power off the aircraft and re-calibrate the compass at a different location and then resume the flight.

- Compass error, exit P-GPS Mode

This warning message indicates that the aircraft is drifting severely. Bring the aircraft to a higher altitude to gain enough GPS satellite locks when this warning message is prompted. The flight controller will automatically adjust the orientation of the aircraft in the midair to mitigate the drifts. The aircraft will switch back to P-GPS mode when the automatic adjustment is completed.

How to troubleshoot aircraft initialization error?

If you observe the following symptoms, it indicates the aircraft has failed to initialize:

- The aircraft status indicator display flashing red, yellow and green. Even the aircraft is stationed on the flat surface.
- The System Status Bar in the app prompts "Initialization Error".
- No resistance drive if felt on the gimbal.

Various factors contribute to the aircraft initialization error, try resolve the issue by following the suggestions listed below:

- Sensor performance degraded. This may be due to the excessive bias detected from the IMU or the compass reading is interfered. Try restarting and calibrating the IMU and compass to resolve this issue.
- Sensor is defective. If the sensors remains unchanged at all time and the problem persist even when the aircraft is restarted, it indicates the sensor is not working normally. Users should return the aircraft to DJI for repairing.
- Minor vibration is detected during aircraft initialization. Put the aircraft on the flat surface, power on the aircraft and ensure the aircraft is stationed for more than 5 seconds to resolve the issue.
- Serious vibration is detected during aircraft initialization. This instance generally occurs when the aircraft is being initialization on the violent moving surface, for instance, ships that are on the rough sea. Do not attempt to power on the aircraft in this scenario.

Appendix

Appendix

Specifications

Aircraft

| | |
|--|---|
| Weight (Battery & Propellers Included) | 1280 g |
| Max. Ascent Speed | 5 m/s |
| Max. Descent Speed | 3 m/s |
| Max. Speed | 16 m/s (ATTI mode, no wind) |
| Max Service Ceiling Above Sea Level | 6000 m (Software altitude limit: 120 m above takeoff point) |
| Max. Flight Time | Approximately 23 minutes |
| Operating Temperature | 0°C to 40°C |
| GPS Mode | GPS/GLONASS |

Gimbal

| | |
|--------------------|-----------------------|
| Controllable Range | Pitch: - 90° to + 30° |
|--------------------|-----------------------|

Vision Positioning

| | |
|-----------------------|--|
| Velocity Range | < 8 m/s (2 m above ground) |
| Altitude Range | 30 cm-300 cm |
| Operating Range | 30 cm-300 cm |
| Operating Environment | Brightly lit (lux > 15) patterned surfaces |

Camera

| | |
|--------------------------|---|
| Sensor | Sony EXMOR 1/2.3" Effective pixels:12.4 M (total pixels: 12.76 M) |
| Lens | FOV 94° 20mm (35mm format equivalent) f/2.8 |
| ISO Range | 100-3200 (video) 100-1600 (photo) |
| Electronic Shutter Speed | 8s - 1/8000s |
| Image Max. Size | 4000 × 3000 |

| | |
|-------------------------|-------------------------------------|
| | Single shot |
| | Burst shooting: 3/5/7 frames |
| Still Photography Modes | Auto Exposure Bracketing (AEB): 3/5 |
| | Bracketed frames at 0.7EV Bias |
| | Time-lapse |

| | |
|-------------------------|---|
| Supported SD Card Types | Micro SD |
| | Max. capacity: 64 GB. Class 10 or UHS-1 rating required |

| | |
|-----------------------|-------------------------------------|
| Video Recording Modes | 2.7K: 2704 × 1520p 24/25/30 (29.97) |
| | FHD:1920 × 1080p 24/25/30/48/50/60 |
| | HD:1280 × 720p 24/25/30/48/50/60 |

| | |
|-------------------------------|-----------------------------------|
| Max. Bitrate Of Video Storage | 40 Mbps |
| | FAT32/exFAT |
| Supported File Formats | Photo: JPEG, DNG |
| | Video: MP4/MOV (MPEG-4 AVC/H.264) |

| | |
|-----------------------------|-------------|
| Operating Temperature Range | 0°C to 40°C |
|-----------------------------|-------------|

Remote Controller

| | |
|-----------------------------|---|
| Operating Frequency | 2.400 GHz-2.483 GHz |
| Transmitting Distance | Up to 5.0 km or 3.1 miles (unobstructed, free of interferences and FCC compliant) when it is FCC compliant Up to 3.5 km or 2.1 miles (unobstructed, free of interferences) when it is CE compliant |
| Video Output Port | USB |
| Operating Temperature Range | 0°C- 40°C |
| Battery | 6000 mAh LiPo 2S |
| Mobile Device Holder | Tablets and smartphones |
| Transmitter Power (EIRP) | FCC: 20 dbm; CE:16 dbm |
| Working Voltage | 1.2 A @7.4 V |





Charger

| | |
|-------------|--------|
| Voltage | 17.4 V |
| Rated Power | 57 W |







Intelligent Flight Battery (PH3-4480 mAh-15.2 V)

| | |
|-----------------------|-------------|
| Capacity | 4480 mAh |
| Voltage | 15.2 V |
| Battery Type | LiPo 4S |
| Energy | 68 Wh |
| Net Weight | 365 g |
| Operating Temperature | -10°C- 40°C |
| Max. Charging Power | 100 W |

Aircraft Status Indicator Description**Normal**

| | |
|---|--|
|  Red, Green and Yellow Flash Alternately | Turning on and Self-Diagnostics |
|  Green and Yellow Flash Alternately | Aircraft Warming Up |
|  Green Flashes Slowly | Safe to Fly (P-mode with GPS and Vision Positioning) |
|  X2 Green Flashes Twice | Safe to Fly (P-mode with Vision Positioning but without GPS) |
|  Yellow Flashes Slowly | Safe to Fly (A-mode but No GPS and Vision Positioning) |

Warning

| | |
|---|-------------------------------|
|  Fast Yellow Flashing | Remote Controller Signal Lost |
|  Slow Red Flashing | Low Battery Warning |
|  Fast Red Flashing | Critical Battery Warning |
|  Red Flashing Alternately | IMU Error |
|  — Solid Red | Critical Error |
|  Red and Yellow Flash Alternately | Compass Calibration Required |

Firmwares Update

Use Micro SD card to update the aircraft and Intelligent Flight Battery. Connect to the Internet, launch the DJI GO app. The DJI GO app will start checking for available firmware updates automatically. Follow the on-screen instruction to update the latest firmware for the aircraft, remote controller and intelligent flight battery.

Intelligent Flight Mode

Intelligent Flight mode includes Course Lock, Home Lock, Point of Interest (POI), Follow Me and Waypoints features to assist users to create professional shoots during the flight. Course Lock and Home Point lock helps to lock the orientation of aircraft so that the user can focus more on other operations. Point of Interest, Follow Me and Waypoints mode enable aircraft to fly automatically according to the pre-set flight maneuvers.

| | |
|-------------------|---|
| Course Lock | Lock the current nose direction as the aircraft's forward direction. The aircraft will move in the locked directions regardless of its orientation (yaw angle). |
| Home Lock | Pull the pitch stick backward to move the aircraft toward its recorded Home Point. |
| Point of Interest | The aircraft will orbit around the subject automatically to allow the operator can be more focus on framing their shoot on the subject in Point of Interest. |
| Follow Me | A virtual tether is created between the aircraft and the mobile device so that the aircraft can track your movement as you move. Note that Follow Me performance is subject to the GPS accuracy on the mobile device. |
| Waypoints | Record a flight path, then the aircraft will fly along the same path repeatedly while you control the camera and orientation. The flight path can be saved and re-apply in the future. |

Enable Multiple Flight Mode by launching the DJI GO app > Camera View >  > Advanced Settings > Multiple Flight Mode before using the Intelligent Flight Mode for the first time.

After-Sales Information

Visit the following pages to learn more about After-sales policy and warranty information:

1. After-sales Policy: <http://www.dji.com/service>
2. Refund Policy: <http://www.dji.com/service/refund-return>
3. Paid Repair Service: <http://www.dji.com/service/repair-service>
4. Warranty Service: <http://www.dji.com/service/warranty-service>

FCC Compliance

FCC Compliance

This device complies with part 15 of the FCC Rules. Operation is subject to the following two conditions:

- (1) This device may not cause harmful interference, and
- (2) This device must accept any interference received, including interference that may cause undesired operation.

Changes or modifications not expressly approved by the party responsible for compliance could void the user's authority to operate the equipment.

Compliance Information

FCC Warning Message

Any changes or modifications not expressly approved by the party responsible for compliance could void the user's authority to operate the equipment.

This device complies with part 15 of the FCC Rules. Operation is subject to the following two conditions:

- (1) This device may not cause harmful interference, and (2) this device must accept any interference received, including interference that may cause undesired operation.

FCC Radiation Exposure Statement:

This equipment complies with FCC radiation exposure limits set forth for an uncontrolled environment. This equipment should be installed and operated with minimum distance 20cm between the radiator & your body. This transmitter must not be co-located or operating in conjunction with any other antenna or transmitter.

Note: This equipment has been tested and found to comply with the limits for a Class B digital device, pursuant to part 15 of the FCC Rules. These limits are designed to provide reasonable protection against harmful interference in a residential installation. This equipment generates uses and can radiate radio frequency energy and, if not installed and used in accordance with the instructions, may cause harmful interference to radio communications. However, there is no guarantee that interference will not occur in a particular installation. If this equipment does cause harmful interference to radio or television reception, which can be determined by turning the equipment off and on, the user is encouraged to try to correct the interference by one or more of the following measures:

- Reorient or relocate the receiving antenna.
- Increase the separation between the equipment and receiver.
- Connect the equipment into an outlet on a circuit different from that to which the receiver is connected.
- Consult the dealer or an experienced radio/TV technician for help.

IC RSS warning

This device complies with Industry Canada licence-exempt RSS standard (s). Operation is subject to the following two conditions: (1) this device may not cause interference, and (2) this device must accept any interference, including interference that may cause undesired operation of the device.

Le présent ariel est conforme aux CNR d'Industrie Canada licenciables aux ariels radio exempts de licence.

L'exploitation est autorisée aux deux conditions suivantes:

- (1) l'areil ne doit pas produire de brouillage, et
- (2) l'utilisateur de l'areil doit accepter tout brouillage radioélectrique subi, même si le brouillage est

susceptible d'en compromettre le fonctionnement.

IC Radiation Exposure Statement:

This equipment complies with IC RF radiation exposure limits set forth for an uncontrolled environment. This transmitter must not be co-located or operating in conjunction with any other antenna or transmitter. This equipment should be installed and operated with minimum distance 20cm between the radiator& your body.

Any Changes or modifications not expressly approved by the party responsible for compliance could void the user's authority to operate the equipment.

KCC Warning Message

“해당 무선설비는 운용 중 전파혼신 가능성이 있으므로 인명안전과 관련된 서비스는 할 수 없습니다.”
“해당 무선설비는 운용 중 전파혼신 가능성이 있음”

NCC Warning Message

低功率電波輻射性電機管理辦法

第十二條經型式認證合格之低功率射頻電機，非經許可，公司、商號或使用者均不得擅自變更頻率、加大功率或變更原設計之特性及功能。

第十四條低功率射頻電機之使用不得影響飛航安全及干擾合法通信；經發現有干擾現象時，應改善至無干擾時方得繼續使用。前項合法通信，指依電信法規定作業之無線電通信。低功率射頻電機須忍受合法通信或工業、科學及醫療用電波輻射性電機設備之干擾。



This content is subject to change.

Download the latest version from
<http://www.dji.com/product/phantom-3>

If you have any questions about this document, please contact DJI by sending a message to DocSupport@dji.com.