

MiniDisc Deck

Operating Instructions



MDLP

MDS-JE640

MDS-JE440

©2000 Sony Corporation

WARNING

To prevent fire or shock hazard, do not expose the unit to rain or moisture.

This appliance is classified as a CLASS 1 LASER product. The CLASS 1 LASER PRODUCT MARKING is located on the rear exterior.



The following caution label is located inside the unit.



IN NO EVENT SHALL SELLER BE LIABLE FOR ANY DIRECT, INCIDENTAL OR CONSEQUENTIAL DAMAGES OF ANY NATURE, OR LOSSES OR EXPENSES RESULTING FROM ANY DEFECTIVE PRODUCT OR THE USE OF ANY PRODUCT.

For customers in the U.S.A.

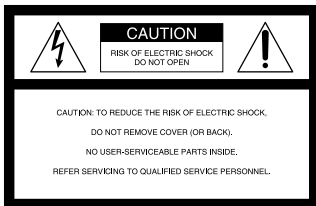

This symbol is intended to alert the user to the presence of uninsulated “dangerous voltage” within the product’s enclosure that may be of sufficient magnitude to constitute a risk of electric shock to persons.



This symbol is intended to alert the user to the presence of important operating and maintenance (servicing) instructions in the literature accompanying the appliance.

CAUTION

You are cautioned that any changes or modification not expressly approved in this manual could void your authority to operate this equipment.

INFORMATION

This equipment has been tested and found to comply with the limits for a Class B digital device, pursuant to Part 15 of the FCC Rules. These limits are designed to provide reasonable protection against harmful interference in a residential installation. This equipment generates, uses, and can radiate radio frequency energy and, if not installed and used in accordance with the instructions, may cause harmful interference to radio communications. However, there is no guarantee that interference will not occur in a particular installation. If this equipment does cause harmful interference to radio or television reception, which can be determined by turning the equipment off and on, the user is encouraged to try to correct the interference by one or more of the following measures:

- Reorient or relocate the receiving antenna.
- Increase the separation between the equipment and receiver.
- Connect the equipment into an outlet on a circuit different from that to which the receiver is connected.
- Consult the dealer or an experienced radio/TV technician for help.

Owner's Record

The model and serial numbers are located on the rear of the unit. Record the serial number in the space provided below. Refer to them whenever you call upon your Sony dealer regarding this product.

Model No. _____
Serial No. _____



ENERGY STAR® is a U.S. registered mark. As an ENERGY STAR® Partner, Sony Corporation has determined that this

product meets the ENERGY STAR® guidelines for energy efficiency.

For customers in Canada

This Class B digital apparatus complies With Canadian ICES-003.

CAUTION

TO PREVENT ELECTRIC SHOCK, DO NOT USE THIS POLARIZED AC PLUG WITH AN EXTENSION CORD, RECEPTACLE OR OTHER OUTLET UNLESS THE BLADES CAN BE FULLY INSERTED TO PREVENT BLADE EXPOSURE.

Welcome!

Thank you for purchasing the Sony MiniDisc Deck. Before operating the deck, please read this manual thoroughly and retain it for future reference.

About this manual

The instructions in this manual are for models MDS-JE640 and MDS-JE440. The MDS-JE640 is the model used for illustration purposes. Any difference in operation is clearly indicated in the text, for example, “MDS-JE640 only”.

Conventions

- Controls in these instructions are those on the deck; these may, however, be substituted by controls on the supplied remote that are similarly named, or, when different, appear in the instructions within parentheses. Example: Turn AMS clockwise (or press ►► repeatedly).
- The following icons are used in this manual:

- Indicates a procedure that requires use of the remote.
- Indicates hints and tips for making the task easier.

TABLE OF CONTENTS

Location and Function of Controls

- Front panel description 4
- Rear panel description 6
- Remote control description 6
- Display window description 8

Getting Started

- Before you start the hookup 10
- Hooking up the audio components 11

Recording to MDs

- Recording to an MD 13
- Notes on recording 15
- Recording for long times 15
- Adjusting the recording level 16
- Recording tips 17
- Marking track numbers while recording (Track Marking) 19
- Starting recording with six seconds of prestored audio data (Time Machine Recording) 20
- Synchro-recording with the audio component of your choice (Music Synchro-recording) 20
- Synchro-recording with a Sony CD player (CD Synchro-recording) 21

Playing MDs

- Playing an MD 23
- Playing a specific track 24
- Locating a particular point in a track 25
- Playing tracks repeatedly (Repeat Play) 26
- Playing tracks in random order (Shuffle Play) 27
- Creating your own program (Program Play) 27
- Tips for recording from MDs to tape (MDS-JE640 only) 29

Editing Recorded MDs

- Before you start editing 30
- Erasing tracks (ERASE) 31
- Dividing tracks (DIVIDE) 33
- Combining tracks (COMBINE) 34
- Moving tracks (MOVE) 34
- Naming a track or MD (NAME) 35
- Changing the recorded level after recording (S.F EDIT) 37
- Undoing the last edit (UNDO) 39

Other Functions

- Changing the pitch (Pitch Control Function) (MDS-JE640 only) 40
- Fading in and fading out 41
- Falling asleep to music (Sleep Timer) 42
- Using a timer (MDS-JE640 only) 43
- Using the CONTROL A1II control system (MDS-JE640 only) 44

Operating the MD Deck Using a Keyboard

- Setting the keyboard 46
- Naming a track or MD using the keyboard 47
- Operating the deck using the keyboard 48
- Assigning characters to keyboard keys 48

Additional Information

- Precautions 50
- Handling MDs 51
- System limitations 51
- Troubleshooting 52
- Self-diagnosis function 53
- Display messages 54
- Specifications 55
- Edit menu table 56
- Setup menu table 56

Index 58

Location and Function of Controls

This chapter describes the location and function of the various buttons, controls, and jacks on the deck and the supplied remote. Further details are provided on the pages indicated in the parentheses.

It also describes the information that appears in the display window.

Front panel description

- 1 I/⏻ (power) switch/STANDBY indicator (13) (23)
Press to turn on the deck. When you turn on the deck, the STANDBY indicator turns off. When you press the switch again, the deck turns off and the indicator lights up.

- 2 Remote sensor (MDS-JE640 only) (10)
Point the remote toward this sensor (R) for remote operations. For MDS-JE440, the remote sensor is located on the display window.

- 3 MD insertion slot (13) (23)
Insert an MD as illustrated below.

With the labeled side up

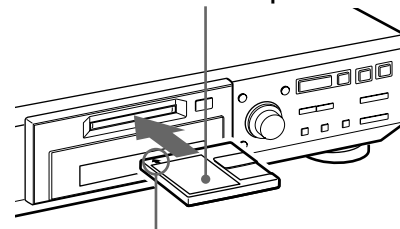

With the arrow pointing toward the deck

- 4 MD LP indicator (15) (23)
Lights when the deck is playing or recording to an MD in LP2 or LP4 Stereo mode.
- 5 ≡ button (14) (23)
Press to eject the MD.
- 6 MENU/NO button (17) (27) (30) (46) (56)
Press to display the Edit Menu or Setup Menu.
- 7 YES button (17) (27) (30) (46)
Press to carry out the selected operation.

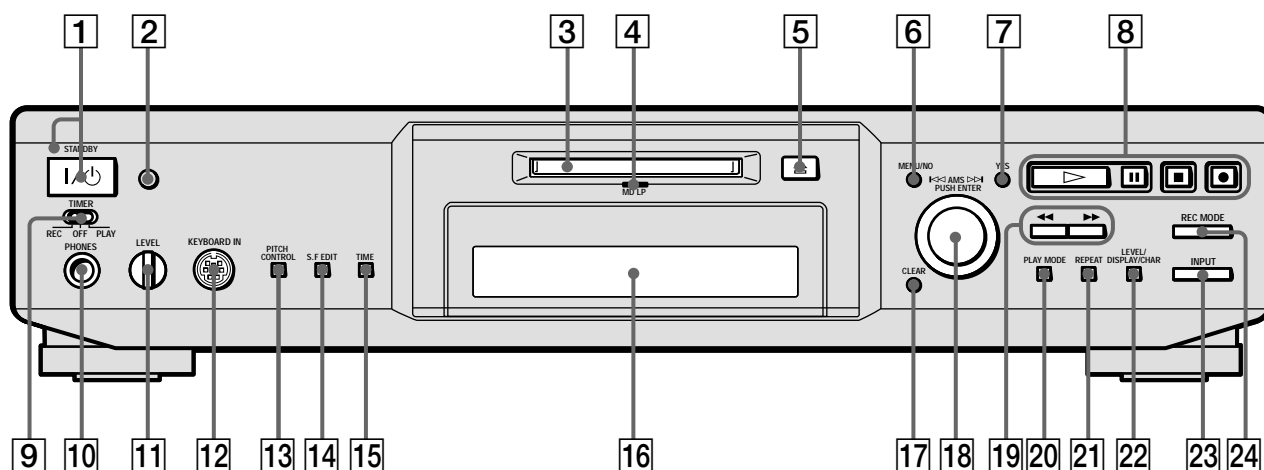

- 8 ▷ button (13) (23)**
Press to start play.
 - ▬ button (13) (23)**
Press to pause play or recording. Press again to resume play or recording.
 - button (14) (23)**
Press to stop play or recording, or cancel the selected operation.
 - button (13) (17) (19)**
Press to record to the MD, monitor the input signal, or mark track numbers.
 - 9 TIMER selector (MDS-JE640 only) (43)**
Use to set the timer for recording (REC) or playing (PLAY). Set to OFF to turn off the timer.
 - 10 PHONES jack (MDS-JE640 only) (23)**
Connect headphones to this jack.
 - 11 LEVEL control (MDS-JE640 only) (23)**
Turn to adjust the volume of the headphones.
 - 12 KEYBOARD IN jack (MDS-JE640 only) (46)**
Connect a keyboard to this jack to operate the deck using the keyboard.
 - 13 PITCH CONTROL button (MDS-JE640 only) (40)**
Press to set the MD playback speed (pitch). When you have set the pitch to a value other than “0”, the button lights up during play.
 - 14 S.F EDIT button (MDS-JE640 only) (37)**
Press to change the recorded level after recording. The button lights up during the operation.
 - 15 TIME button (MDS-JE640 only) (17) (21)**
Press to display the remaining time.
- SCROLL button (MDS-JE440 only) (24)**
Press to scroll the name of a track or an MD.

- 16 Display window (8)**
Shows various information.
 - 17 CLEAR button (27) (35)**
Press to cancel the selection.
 - 18 AMS control (13) (23) (30) (40) (46)**
Turn to locate tracks, select the input characters, or select a menu item and a setting value.
 - 19 ◀▶ buttons (25) (27) (30) (35)**
Press to locate a portion within a track, change the contents of a program, or change the input character.
 - 20 PLAY MODE button (27) (43)**
Press to select Shuffle Play or Program Play or resume normal play.
 - 21 REPEAT button (26)**
Press to play tracks repeatedly.
 - 22 LEVEL/DISPLAY/CHAR button (9) (14) (16) (24) (27) (35)**
- | Press while the deck is | To |
|------------------------------|---|
| Recording or recording pause | Adjust the recording level |
| Stopped | Display disc information or the contents of a program |
| Recording | Display information on the track being recorded |
| Playing | Display information on the current track |
| Editing | Select the type of characters to be input |
- 23 INPUT button (13)**
Press to select the input jack (or connector) of the program source to be recorded.
 - 24 REC MODE button (15)**
Press to set the REC MODE to stereo, LP2, LP4 or MONO.

Rear panel description

MDS-JE640

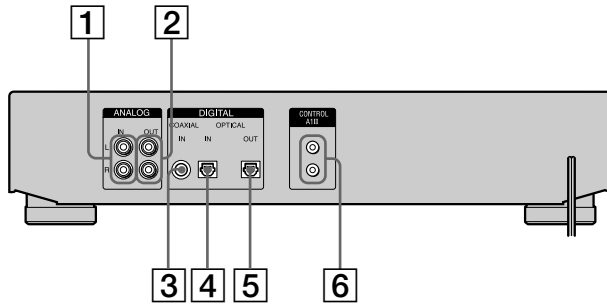



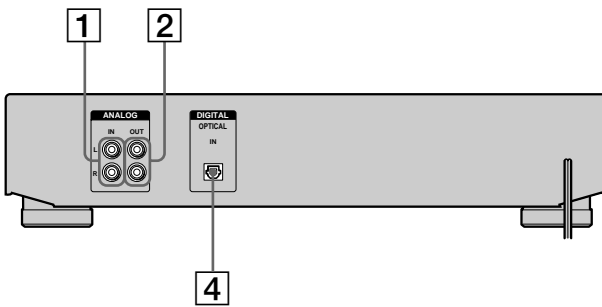





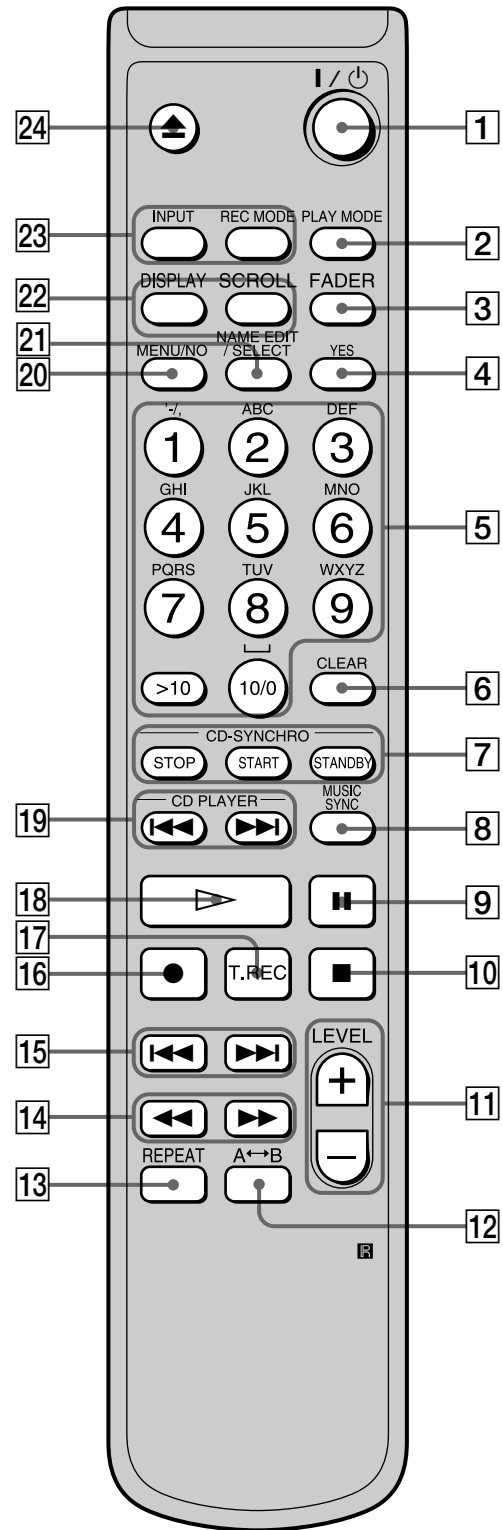

MDS-JE440



- 1 ANALOG IN jacks (11) (13)**
Use to input analog signals from other components.
- 2 ANALOG OUT jacks (11)**
Use to output analog signals to other components.
- 3 DIGITAL COAXIAL IN jack (MDS-JE640 European models only) (11) (13)**
Connect a digital coaxial cable to input digital signals from other components.
- 4 DIGITAL OPTICAL IN connector (11) (13)**
Connect a digital optical cable to input digital signals from other components. If your deck has IN1 and IN2 connectors, you can use either connector.
- 5 DIGITAL OPTICAL OUT connector (11)**
Connect a digital optical cable to output digital signals to other components.
- 6 CONTROL A1II jacks (11) (44)**

Remote control description



- 1** **I/⏻ (power) switch (13) (23)**
Press to turn on the deck. When you turn on the deck, the STANDBY indicator on the deck turns off. When you press the switch again, the deck turns off and the indicator lights up.
- 2** **PLAY MODE button (27) (43)**
Press to select Shuffle Play or Program Play or resume normal play.
- 3** **FADER button (41) **
Press to perform Fade-in Play/Recording or Fade-out Play/Recording.
- 4** **YES button (17) (27) (30) (46)**
Press to carry out the selected operation.
- 5** **Letter/number buttons (24) (35) **
Press to input letters or numbers or select a track.
- 6** **CLEAR button (27) (35)**
Press to cancel the selection.
- 7** **CD-SYNCRO STOP button (21) **
Press to stop CD Synchro-recording.
CD-SYNCRO START button (21) 
Press to start CD Synchro-recording.
CD-SYNCRO STANDBY button (21) 
Press to enter standby for CD Synchro-recording.
- 8** **MUSIC SYNC button (20) **
Press to start Music Synchro-recording.
- 9** **|| button (13) (23)**
Press to pause play or recording. Press again to resume play or recording.
- 10** **■ button (14) (23)**
Press to stop play or recording, or cancel the selected operation.
- 11** **LEVEL +/- buttons (16) (23) **
Press to adjust the recording level or analog output level (MDS-JE640 only).
- 12** **A↔B button (26) **
Press to select Repeat A-B Play.
- 13** **REPEAT button (26)**
Press to play tracks repeatedly.
- 14** **◀▶ buttons (25) (27) (30) (35)**
Press to locate a portion within a track, change the contents of a program, or shift the cursor to the right.
- 15** **◀◀/▶▶ buttons (13) (23) (31) (40) (46)**
Press to locate tracks, adjust the recording level or select a menu item.
- 16** **● button (13) (17) (19)**
Press to record to the MD, monitor the input signal, or mark track numbers.
- 17** **T.REC button (20) **
Press to start Time Machine Recording.
- 18** **▷ button (13) (23)**
Press to start play.
- 19** **CD PLAYER ◀◀/▶▶ buttons (21) **
Press to locate tracks on the CD.
- 20** **MENU/NO button (17) (27) (30) (46) (56)**
Press to display the Edit Menu or Setup Menu.
- 21** **NAME EDIT/SELECT button (35) **
Press to add the name, change the name of a track or an MD or select the type of characters to be input.
- 22** **DISPLAY button (9) (14) (16) (24) (27)**
Press to select the information to be displayed in the window.
SCROLL button (24) 
Press to scroll the name of a track or an MD.
- 23** **INPUT button (13)**
Press to select the input jack (or connector) of the program source to be recorded.
REC MODE button (15)
Press to set the REC MODE to stereo, LP2, LP4 or MONO.
- 24** **▲ button (14) (23)**
Press to eject the MD.

Display window description

MDS-JE640

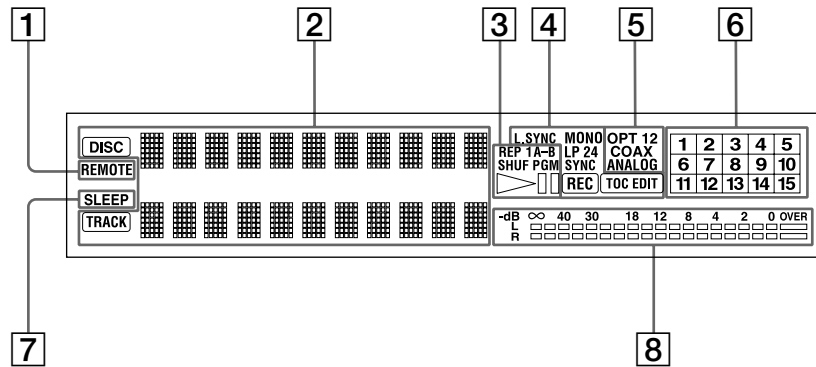

MDS-JE440

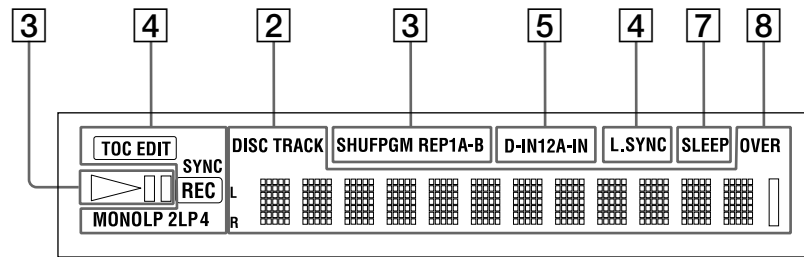

1 REMOTE indicator

Lights when the MD is being controlled by an external device connected to the deck.

2 Disc name and track name indicators display

DISC indicator

Lights when the disc information (etc.) is shown.

Name display

Displays disc and track names, Edit Menu parameters, and Setup Menu parameters (etc.).

The track name appears instead of the disc name during play. When the MD or the track has no name, "No Name" appears.

TRACK indicator

Lights when the track information (etc.) is shown.

3 Playback indicators

REP indicators (26)

Light when the deck is set to Repeat Play.

- "REP" lights when the deck is set to repeat the entire disc.
- "REP 1" lights when the deck is set to repeat just one track.
- "REP A-B" lights when the deck is set to repeat a specific portion within a track.

SHUF indicator (27)

Lights when the deck is set to Shuffle Play.

PGM indicator (27)

Lights when the deck is set to Program Play.

▷||| indicator

Lights during playing or playing pause.

4 Recording and editing indicators**L.SYNC indicator (19)**

Lights when the deck is set to assign track numbers automatically during analog recording.

Rec mode indicators (15)

These indicators turn off during stereo recording/playback.

- “MONO” lights when the deck is set to Monaural Recording mode or playing an MD recorded in Monaural Recording mode.
- “LP2” lights when the deck is set to LP2 Stereo Recording mode or playing an MD recorded in LP2 Stereo Recording mode.
- “LP4” lights when the deck is set to LP4 Stereo Recording mode or playing an MD recorded in LP4 Stereo Recording mode.

SYNC indicator (20)

Lights during synchro-recording.

REC indicator

Lights during recording.

TOC indicators (15) (31)

- “TOC” lights to indicate the presence of TOC data that has not been written to the disc. “TOC” flashes when the TOC data is being written.
- “TOC EDIT” lights during edit operations.

5 INPUT indicators (13)

- “OPT” or “D-IN” lights when the program source connected to the DIGITAL OPTICAL IN connector is selected. For models with two digital input connectors, “OPT1 (2)” lights when the program source connected to the DIGITAL OPTICAL IN1 (2) connector is selected.
- “COAX” lights when the program source connected to the DIGITAL COAXIAL IN jack (MDS-JE640 European models only) is selected.
- “ANALOG” or “A-IN” lights when the program source connected to the ANALOG IN jacks is selected.

6 Music calendar

Shows all the track numbers within a grid if the MD is a premastered disc, or without a grid if the MD is a recordable disc. If the total number of tracks exceeds 15, ► appears to the right of number 15 in the music calendar.

7 SLEEP indicator (42)

Lights when the deck is set to turn off automatically after specified minutes.

8 Level meters

Display the audio signal levels during playing and recording.

Note

The display format that you have selected in each of the deck statuses (play, recording, etc.) will appear whenever the deck enters that status and you press LEVEL/DISPLAY/CHAR (or DISPLAY) or TIME (MDS-JE640 only) until you change the format to another (see the following sections for details). If you disconnect the AC power cord, however, all the displays will revert to their default (i.e., the factory set display) the next time you turn on the deck.

To change the display in stop mode

Press LEVEL/DISPLAY/CHAR (or DISPLAY) repeatedly to change the display.

Each press of the button changes the display as follows:

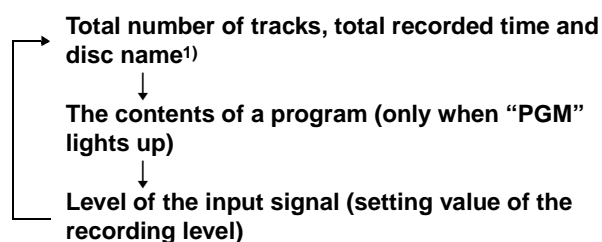
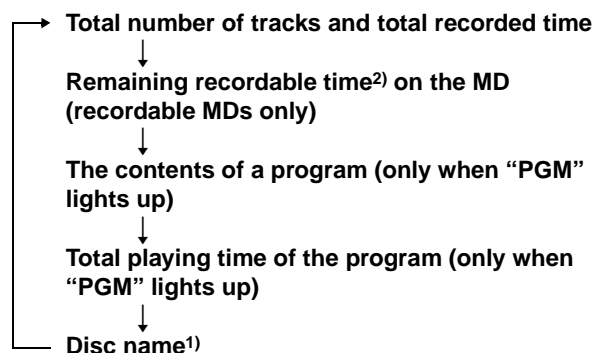
MDS-JE640**MDS-JE440**

1) “No Name” appears when the disc has no name.

2) Time shown in the display differs depending on the setting of REC MODE.

Getting Started

This chapter provides information on the supplied accessories and hookups. Be sure to read this chapter thoroughly before you actually connect any equipment to the deck.

Before you start the hookup

Checking the supplied accessories

This MD deck comes with the following items:

- Audio connecting cords (2)
- Optical cable (1)
- Remote commander (remote) (1)
- R6 (size-AA) batteries (2)

Inserting batteries into the remote

Insert two R6 (size-AA) batteries into the battery compartment with the + and – properly oriented to the markings. When using the remote, point it at the remote sensor  on the deck.

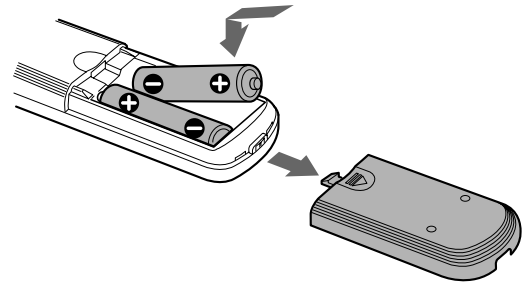

When to replace the batteries

Under normal conditions, the batteries should last for about six months. When the remote no longer operates the deck, replace both batteries with new ones.

Notes

- Do not leave the remote in an extremely hot or humid place.
- Do not drop any foreign object into the remote casing, particularly when replacing the batteries.
- Do not use a new battery with an old one.
- Do not expose the remote sensor to direct sunlight or lighting apparatus. Doing so may cause a malfunction.
- If you don't use the remote for an extended period of time, remove the batteries to avoid possible damage from battery leakage and corrosion.

Hooking up the audio components

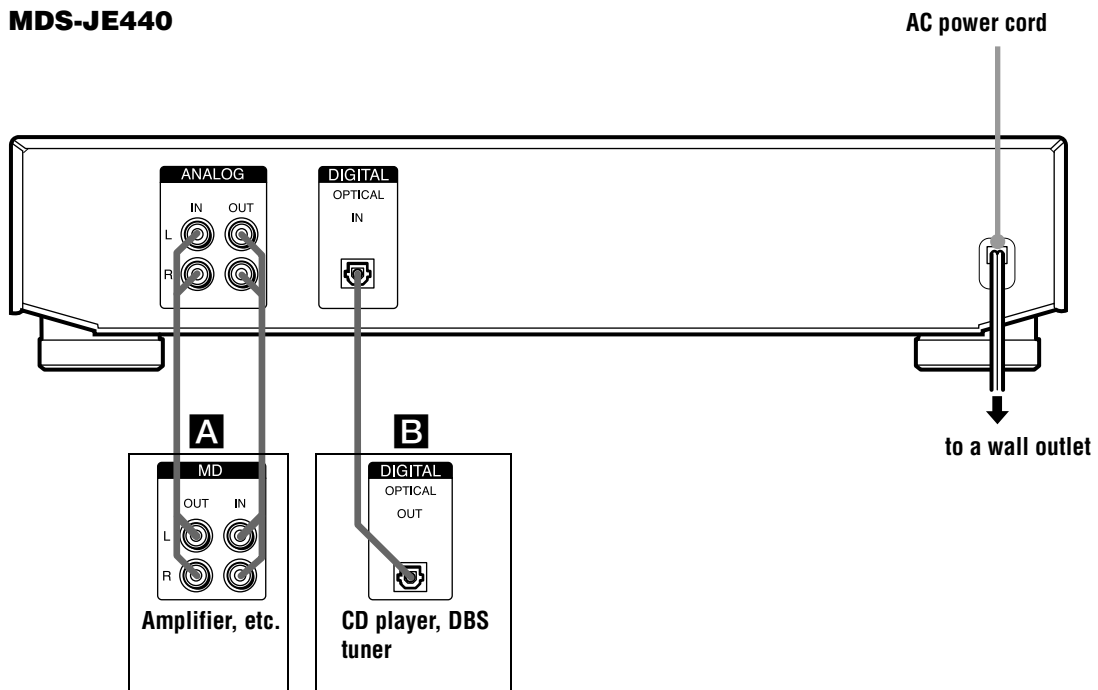
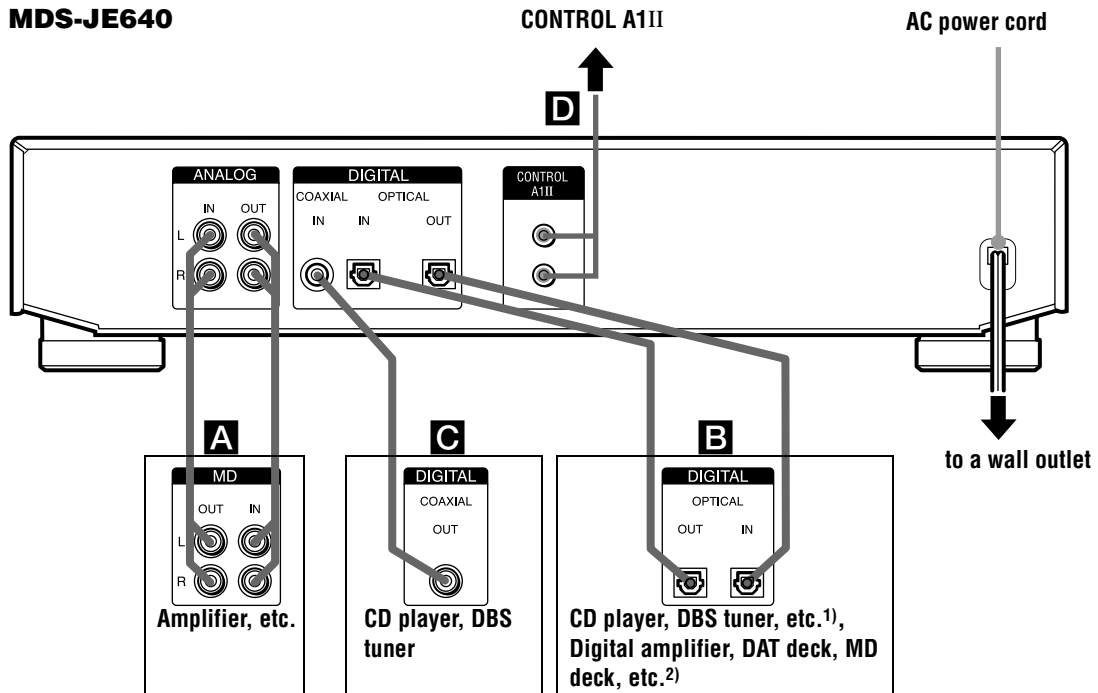

1) Digital equipment with a DIGITAL OUT connector only
 2) Digital equipment with both DIGITAL IN and OUT connectors

Required cords

A Audio connecting cords (2) (supplied)

When connecting an audio connecting cord, be sure to match the color-coded pins to the appropriate jacks: white (left) to white and red (right) to red.

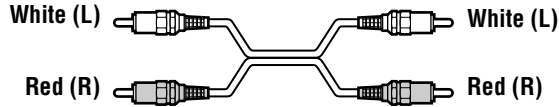

B Optical cables (2 for MDS-JE640 European models/3 for all other models) (only one supplied)

- When connecting an optical cable, take the caps off the connectors and insert the cable plugs straight in until they click into place.
- Do not bend or tie the optical cables.

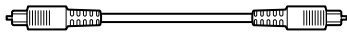

C Coaxial digital connecting cable (for MDS-JE640 European models only) (1) (not supplied)

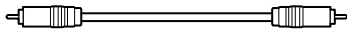

Hookup considerations

- Turn off the power of all components before making any connections.
- Do not connect any AC power cord until all the connections are completed.
- Be sure the connections are firm to prevent hum and noise.

Jacks (connectors) for connecting audio components

For MDS-JE640 European models

Connect	To the
Amplifiers	ANALOG IN/OUT jacks
CD players or DBS tuners	DIGITAL COAXIAL IN jack or DIGITAL OPTICAL IN connector
Digital amplifiers, DAT decks, or another MD deck	DIGITAL OPTICAL IN/OUT connectors

For MDS-JE640 (except for the European models)

Connect	To the
Amplifiers	ANALOG IN/OUT jacks
CD players or DBS tuners	DIGITAL OPTICAL IN ¹⁾ connector
Digital amplifiers, DAT decks, or another MD deck	DIGITAL OPTICAL IN ^{1)/} OUT connectors

1) There is no distinction of IN1 and IN2 connectors.

For MDS-JE440

Connect	To the
Amplifiers	ANALOG IN/OUT jacks
CD players or DBS tuners	DIGITAL OPTICAL IN connector

Other connections (MDS-JE640 only)

To connect a CONTROL A1II compatible component

D Monaural (2P) mini-plug cables (2) (not supplied)

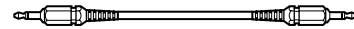

For details, see “Using the CONTROL A1II control system” on page 44.

To connect the AC power cord

Connect the AC power cord of the deck to a wall outlet.

Note

If you use a timer, connect the AC power cord to the outlet of the timer.

Demonstration mode

When you turn on the MD deck and there is no MD in the deck, demonstration mode is activated automatically after about ten minutes. To deactivate the demonstration mode, press any button on the deck or on the remote.

💡 To turn off the demonstration mode

Press **■** and CLEAR simultaneously when there is no MD in the deck.

“Demo Off” appears in the display.

To turn on the demonstration mode again, perform the same procedure described above.

“Demo On” appears in the display.

Recording to MDs

This chapter explains the various ways to record to an MD, as well as how to mark track numbers and perform synchro-recording with other components. See also “System limitations” on page 51 before recording.

Recording to an MD

If the MD has been partially recorded, recording starts after the recorded tracks.

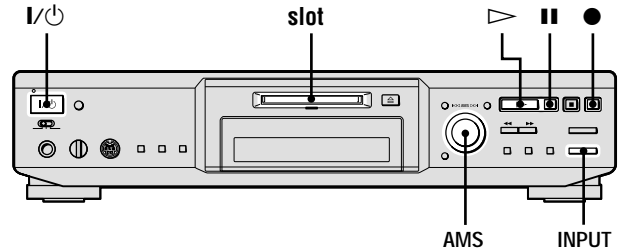

- 1 Turn on the amplifier and program source, and select the source on the amplifier.**
- 2 Press I/⏻ to turn on the deck.**
The STANDBY indicator turns off.
- 3 Insert a recordable MD into the slot.**
- 4 Press INPUT repeatedly to select the input jacks (connector) connected to the program source.**

When the source is connected to the	Set INPUT to
DIGITAL OPTICAL IN1 or IN2 connector	OPT1 or OPT2
DIGITAL OPTICAL IN connector	OPT or D-IN
DIGITAL COAXIAL IN jack ¹⁾	COAX
ANALOG IN jacks	ANALOG or A-IN

1) MDS-JE640 European models only

- 5 If necessary, locate the point on the MD to start recording from.**
If you want to record to a new MD or start recording from the end of the recorded portion, skip this step and go to step 6.

To record over from the beginning of an existing MD track

Turn AMS (or press ◀◀/▶▶ repeatedly) until the number of the track to be recorded over appears.

To record over from the middle of an MD track

Turn AMS (or press ◀◀/▶▶ repeatedly) until the number of the track to be recorded over appears, then press ▶ to start play. Press ⏻ at the point you want to start recording from.

- 6 Press ●.**
The deck changes to recording pause.
- 7 If necessary, adjust the recording level.**
For details, see “Adjusting the recording level” on page 16.
- 8 Press ▶ or ⏻.**
Recording starts.

9 Start playing the program source.

Operations you may want to do during recording

To	Press
Stop recording	■
Pause recording	
Resume recording after pausing	▷ or
Eject the MD	⏏ after stopping recording

To change the display while recording

Press LEVEL/DISPLAY/CHAR (or DISPLAY) repeatedly to change the display.

Each press of the button changes the display as follows:

MDS-JE640

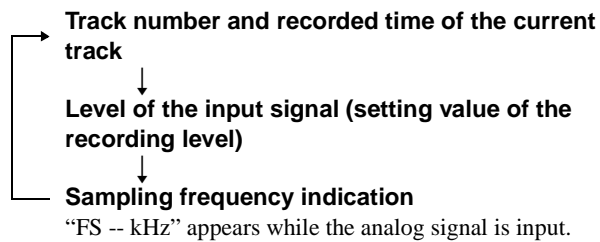

MDS-JE440

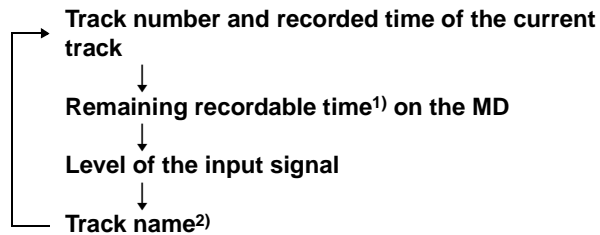

1) Time shown in the display differs depending on the setting of REC MODE.

2) "No Name" appears when the track has no name.

When you pause recording

The track number increases by one. For example, if you paused recording while recording track 4, the track number will be 5 when you resume recording.

To prevent accidental erasure of the recorded material

To protect an MD recording, slide the record-protect tab in the direction of the arrow (see illustration below) to open the slot. To enable re-recording, close the slot.

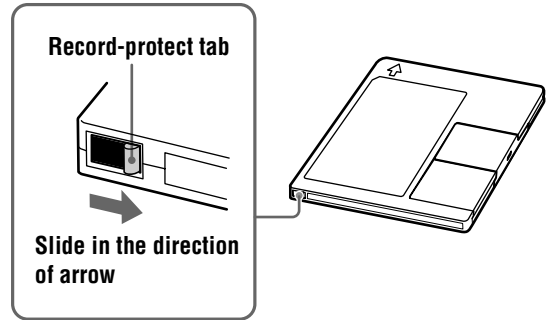

💡 You can play the tracks you have just recorded

Press ▷ immediately after stopping recording. The deck starts to play from the first track of the material just recorded.

💡 You can play from the first track of the MD after recording

- 1 Press ■ again after stopping recording.
- 2 Press ▷.

The deck starts to play from the first track of the MD.

Note

You cannot record over existing material when Shuffle Play (page 27) or Program Play (page 27) has been selected. "Impossible" appears in the display at this time.

Notes on recording

About indications that appear during/after recording

When “Tr” flashes in the display during recording

The MD deck is recording over existing track(s) (see “Recording to an MD” on page 13). The indication stops flashing when the deck reaches the end of the recorded portion.

When “TOC” lights up in the display after recording

Recording has finished but the TOC (Table of Contents) on the MD has not been updated to reflect the recording results. The recording will be lost if you disconnect the AC power cord while the indication is on. The TOC will be updated only when you eject the MD or turn off the MD deck.

When “TOC Writing” flashes in the display after recording

The deck is updating the TOC. Do not disconnect the AC power cord or move the deck while the indication flashes.

Automatic conversion of digital sampling rates during recording

A built-in sampling rate converter automatically converts the sampling frequency of various digital sources to the 44.1 kHz sampling rate of the MD deck. This allows you to monitor and record sources such as 32- or 48-kHz DAT tape or satellite broadcasts, as well as the CDs and MDs.

Recording for long times

In addition to normal stereo recording, this deck has two long time recording modes: LP2 and LP4. When recording in LP2 Stereo mode, you can record 2 times the normal recordable time, and in LP4 Stereo mode, you can record 4 times the normal recordable time. In addition, the recordable time for monaural recording is approximately double the stereo recording time.

Note

MDs recorded in MD LP (LP2 or LP4 Stereo) mode cannot be played back on a deck that does not support MD LP mode. In addition, you cannot perform S.F Edit for MDs recorded in MD LP mode.

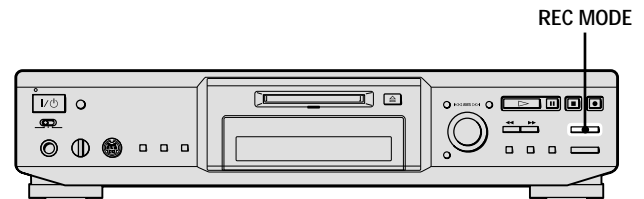

1 Do steps 1 to 4 of “Recording to an MD” on page 13.

2 Press REC MODE repeatedly to select the recording mode you want to record in.

To record in	Set REC MODE to
Stereo	Blank (No indicator)
LP2 Stereo	LP2
LP4 Stereo	LP4
Monaural	MONO

3 Do steps 5 to 9 of “Recording to an MD” on page 13.

You can automatically add “LP:” at the beginning of a track name during a long time recording

The deck is set at the factory to add “LP:” automatically. This indication is displayed when the track is played on a deck that does not support long-time recording (page 57). To turn this function On/Off, press ◀◀ or ▶▶.

💡 When you record to an MD in LP2 or LP4 Stereo mode

The MD LP indicator lights up when you press ● in step 3 above.

Notes

- The recorded “LP:” is a confirmation stamp that is displayed to indicate that the track cannot be played back on a deck that does not support MD LP mode. It is not displayed on decks that support MD LP mode.

- If “LPstamp:On” is set, “LP:” is recorded as part of the track name, so the number of characters that can be input in a single MD is reduced. Furthermore, “LP:” is automatically copied if the track name is copied or if the track is divided by using the Divide function.
- MDs recorded in MD LP (LP2 or LP4 Stereo) mode should be played back on a deck that supports MD LP mode. These MDs cannot be played back on other decks. When you play an MD recorded in MD LP mode, “STEREO” (for an MD recorded in LP2 Stereo mode) or “MONO” (for an MD recorded in LP4 Stereo mode) lights up.
- Even if you press REC MODE during recording or recording pause, you cannot change the recording mode.
- Even if you press REC MODE repeatedly to select MONO, the monitor signal during recording does not become monaural.

Adjusting the recording level

You can adjust the recording level for both analog and digital recordings.

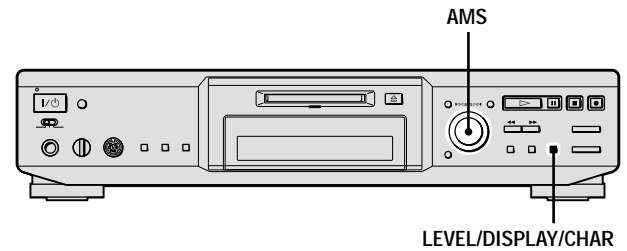

- 1 Do steps 1 to 6 of “Recording to an MD” on page 13.
- 2 Play the portion of the program source with the strongest output.
- 3 Press LEVEL/DISPLAY/CHAR (or DISPLAY) repeatedly until the level of the input signal appears.
- 4 **MDS-JE640**
While monitoring the sound, turn AMS (or press LEVEL +/- repeatedly) to raise the recording level to its highest level without turning on the two rightmost indicators on the peak level meters.

MDS-JE640

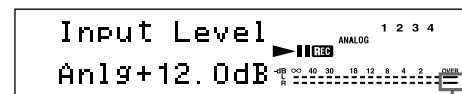

Avoid turning on these indicators

MDS-JE440

While monitoring the sound, turn AMS (or press ◀▶ repeatedly) to raise the recording level to its highest level without turning on “OVER” on the peak level meters.

MDS-JE440

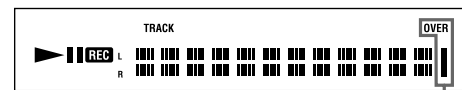

Avoid turning on these indicators

- 5 Stop playing the program source.
- 6 To start recording, continue from step 8 of “Recording to an MD” on page 13.

You can adjust the recording level using the remote .

During recording or recording pause, press LEVEL +/- repeatedly.

💡 You can adjust the recording level without changing the display

In this case, skip step 3 above.
While adjusting the recording level, the level of the input signal appears for about three seconds.

💡 (MDS-JE640 only) You can use Setup Menu to adjust the recording level

- You can adjust the recording level regardless of the source selected with the INPUT button.
- 1 During recording or recording pause, press MENU/NO twice. “Setup Menu” appears in the display.
 - 2 Turn AMS (or press **◀◀/▶▶** repeatedly) until “Ain,” “Coax,” “Opt,” “Opt1,” or “Opt2” appears, then press AMS or YES.
 - 3 Turn AMS (or press **◀◀/▶▶** repeatedly) to adjust the recording level, then press AMS or YES.
 - 4 Press MENU/NO.

💡 You can use the Peak Hold Function

- The function freezes the peak level meters at the highest level reached by the input signal.
- 1 While the deck is stopped or playing, press MENU/NO twice. “Setup Menu” appears in the display.
 - 2 Turn AMS (or press **◀◀/▶▶** repeatedly) until “P.Hold Off” (factory setting) appears, then press AMS or YES.
 - 3 Turn AMS (or press **◀◀/▶▶** repeatedly) to select “P.Hold On”, then press AMS or YES.
 - 4 Press MENU/NO.

To turn off the Peak Hold Function, select “P.Hold Off” in step 3 above.

Note

The volume can only be increased up to +12.0 dB (for analog recording) or +18.0 dB (for digital recording). Therefore, if the output level of the connected component is low, it may not be possible to set the recording level to maximum.

Recording tips

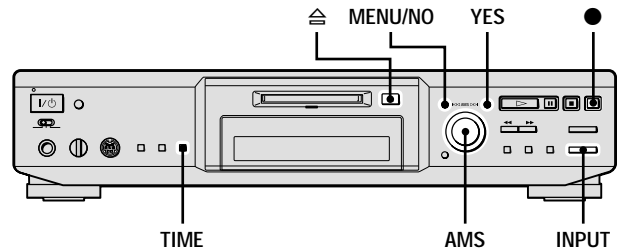

Checking the remaining recordable time on the MD

For MDS-JE640:
Press TIME repeatedly.

While the deck is	The following information appears
Stopped	Total number of tracks and total recorded time ↔ Total number of tracks and remaining recordable time on the MD ¹⁾
Recording	Track number and recorded time of the current track ↔ Track number and remaining recordable time ²⁾ on the MD

- 1) Not shown for premasterd discs.
- 2) Time shown in the display differs depending on the setting of REC MODE.

For MDS-JE440:
Press DISPLAY on the remote repeatedly.

For the information in stop mode, see page 9.
For the information during recording, see page 14.

Monitoring the input signal (Input Monitor)

You can monitor the selected input signal even when you are not recording it.

- 1 Press **⏏** to eject the MD.
- 2 Press INPUT repeatedly to select the jacks (connector) where the signal you want to monitor is being input.
- 3 Press **●**.

When an analog input is selected

The analog signal input from the ANALOG IN jacks is output to the DIGITAL OUT connector (MDS-JE640 only) after A/D conversion, and then to the ANALOG OUT jacks and PHONES jack (MDS-JE640 only) after D/A conversion. “AD – DA” appears in the display during this time.

When a digital input is selected

The digital signal input from the DIGITAL IN connector is output to the DIGITAL OUT connector (MDS-JE640 only) after passing through the sampling rate converter, and then to the ANALOG OUT jacks and PHONES jack (MDS-JE640 only) after D/A conversion. “– DA” appears in the display during this time.

To stop Input Monitor

Press ■.

Erasing blank portions automatically (Smart Space/Auto Cut)

The deck can be set to automatically erase any blanks that are produced when the signal is interrupted during recording. The function that activates (Smart Space or Auto Cut) depends on the length of the interruption, as described below.

Smart Space

If the signal is interrupted for less than 30 seconds, Smart Space replaces the blank portion with a blank space of about three seconds, then continues the recording. “Smart Space” appears in the display during this time.

Auto Cut

If the signal is interrupted for about 30 seconds, Auto Cut replaces the blank portion with a blank space of about three seconds, then pauses the recording. “Auto Cut” appears in the display during this time.

Do the procedure below to turn Smart Space and Auto Cut on or off.

- 1 While the deck is stopped, press MENU/NO twice.**
“Setup Menu” appears in the display.
- 2 Turn AMS (or press ◀▶ repeatedly) until “S.Space On” appears, then press AMS or YES.**
- 3 Turn AMS (or press ◀▶ repeatedly) to select the setting, then press AMS or YES.**

To	Select
Turn on Smart Space and Auto Cut	S.Space On (factory setting)
Turn off Smart Space and Auto Cut	S.Space Off

- 4 Press MENU/NO.**

Notes

- If you start recording with no signal input, Smart Space and Auto Cut will not operate regardless of the setting.
- Smart Space does not affect the order of the track numbers being recorded, even if the blank space occurs in the middle of a track.
- Auto Cut is automatically turned on or off in tandem with Smart Space.

- If you turn off the deck or disconnect the AC power cord, the deck will store the last setting (“S.Space On” or “S.Space Off”) and recall it the next time you turn on the deck.
- If the deck continues recording pause for about 10 minutes after the Auto Cut activated, recording stops automatically.

Marking track numbers while recording (Track Marking)

You can mark track numbers either manually or automatically while recording. By marking track numbers at specific points, you can quickly locate the points later or edit the MD easily.

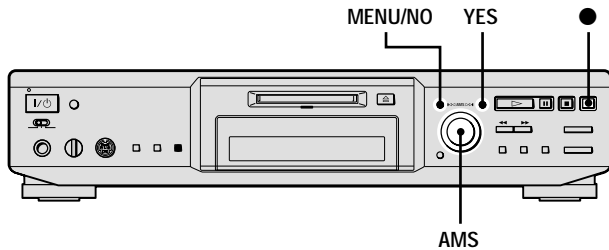

Marking track numbers manually (Manual Track Marking)

While recording, press ● at the point where you want to add a track number.

Marking track numbers automatically (Automatic Track Marking)

When recording from a CD player or MD deck connected to a DIGITAL IN connector, the deck marks track numbers in the same sequence as the source. When recording from other sources connected to the DIGITAL IN connector or a source connected to the ANALOG IN jacks, do the procedure below to mark track numbers automatically. However, you cannot mark track numbers automatically if the sound source to be recorded is noisy (e.g., tapes or radio programs).

- 1 While the deck is stopped, press MENU/NO twice. “Setup Menu” appears in the display.
- 2 Turn AMS (or press ◀◀/▶▶ repeatedly) until “T.Mark Lsyn(c)” appears, then press AMS or YES.
- 3 Turn AMS (or press ◀◀/▶▶ repeatedly) to select the setting, then press AMS or YES.

To	Select
Turn on Automatic Track Marking	T.Mark Lsyn(c) (factory setting)
Turn off Automatic Track Marking	T.Mark Off

4 Press MENU/NO.

When you set Automatic Track Marking to on, “L.SYNC” lights up.

The deck marks a track number whenever the input signal level drops to -50 dB (the trigger level for Automatic Track Marking) or below for at least 1.5 seconds.

To change the trigger level for Automatic Track Marking

Do the procedure below to change the signal level that triggers Automatic Track Marking.

- 1 While the deck is stopped, press MENU/NO twice. “Setup Menu” appears in the display.
- 2 Turn AMS (or press ◀◀/▶▶ repeatedly) until “LS(T)” appears, then press AMS or YES.
- 3 Turn AMS (or press ◀◀/▶▶ repeatedly) to select the level, then press AMS or YES.
You can set the level at any value between -72 dB and 0 dB, in 2 dB increments.
- 4 Press MENU/NO.

💡 Additional information on Automatic Track Marking

- When recording from a CD player or an MD deck connected to the DIGITAL IN connector, the entire material might be recorded as a single track in the following cases:
 - When you consecutively record the same track two or more times using single-track repeat play.
 - When you consecutively record two or more tracks with the same track number but from different CDs or MDs.
 - When you record tracks from certain CD or multi-disc players.
- A track number might not be marked for tracks less than 4 seconds long (in Stereo mode, Monaural mode, and LP2 Stereo mode) or 2 seconds long (in LP4 Stereo mode) during recording.
- When recording from a component connected to the ANALOG IN jacks with “T.Mark Off” selected or when recording from a DAT deck or DBS tuner connected to the DIGITAL IN connector, the entire material may be recorded as a single track.
- When recording from a DAT deck or DBS tuner connected to the DIGITAL IN connector, the deck will mark a track number whenever the sampling frequency of the input signal changes, regardless of the track marking parameter setting (“T.Mark Lsyn(c)” or “T.Mark Off”).

💡 You can mark track numbers even after recording has finished

See “Dividing tracks” on page 33.

Note

If you turn off the deck or disconnect the AC power cord, the deck will store the last settings (“T.Mark Lsyn(c)” or “T.Mark Off” and the trigger level) and recall them the next time you turn on the deck.

Starting recording with six seconds of prestored audio data (Time Machine Recording)

Whenever the deck is in recording pause, the deck's buffer memory continuously stores the latest six seconds worth of audio data. When you press AMS (or T.REC), the recording then starts with the data in the buffer memory. Time Machine Recording thus allows you to avoid missing the beginning of material recorded live from an FM or satellite broadcast.

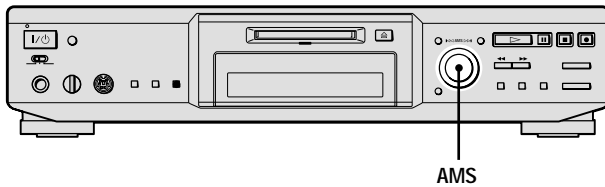

- 1 Do steps 1 to 6 of “Recording to an MD” on page 13.**

The deck changes to recording pause.

- 2 Start playing the program source.**

- 3 Press AMS (or T.REC) at the point where you want to start recording.**

Recording starts with the six seconds of prestored data in the buffer memory, then continues recording via the buffer memory thereafter.

To stop Time Machine Recording

Press ■.

Note

The storage of data in the buffer memory starts from the moment the deck changes to recording pause. Thus, if you start recording less than six seconds after changing to recording pause, less than six seconds worth of data will be recorded from the buffer memory. The same is true if the program source had been playing for less than six seconds at the time you start recording.

Synchro-recording with the audio component of your choice (Music Synchro-recording)



The Music Synchro-recording allows you to automatically synchronize recording to the MD deck with the playing of the selected program source. The Track Marking Function, however, will differ according to the program source. For details, see “Marking track numbers while recording” on page 19.

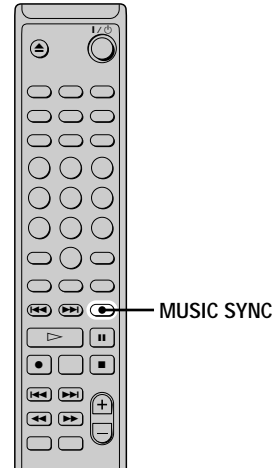

- 1 Do steps 1 to 5 of “Recording to an MD” on page 13.**

- 2 Press MUSIC SYNC.**

The deck changes to recording pause.

- 3 Start playing the program source.**

Recording starts automatically.

To stop Music Synchro-recording

Press ■.

Note

During Music Synchro-recording, Smart Space and Auto Cut will operate regardless of their setting (“S.Space On” or “S.Space Off”).

Synchro-recording with a Sony CD player

(CD Synchro-recording)

When the deck is connected to a Sony CD player or Hi-Fi component system, you can easily copy the contents of CDs to the MD using the deck's remote. Because the MD remote operates both the MD deck and the CD player or CD player section of the component system, make sure to place the MD deck and the CD player as close together as possible.

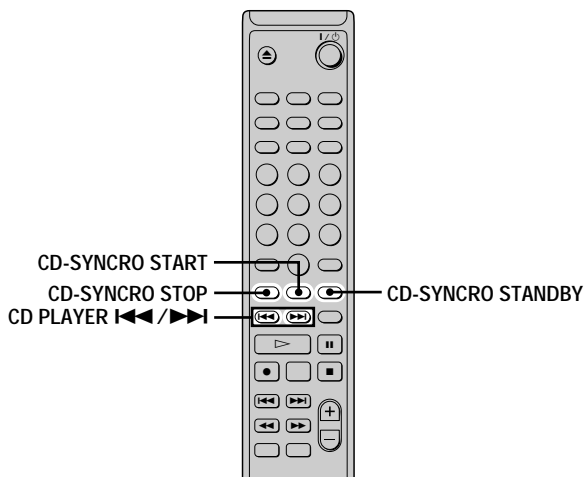

- 1 Turn on the amplifier and the CD player, and select CD on the amplifier.
- 2 Do steps 2 to 5 of "Recording to an MD" on page 13.
- 3 Insert a CD into the CD player and select the playing mode (Shuffle Play, Program Play, etc.) on the CD player.
- 4 Press CD-SYNCHRO STANDBY.
The CD player changes to play standby and the MD deck changes to recording standby.
- 5 Press CD-SYNCHRO START.
The deck starts recording and the CD player starts to play.
The track number and elapsed recording time of the track appear in the display.

If the CD player does not start playing

Some CD players may not respond when you press CD-SYNCHRO START. Press **||** on the CD player's remote instead to start play on the CD player.

Operations you may want to do during CD Synchro-recording

To	Press
Stop recording	CD-SYNCHRO STOP
Pause recording	CD-SYNCHRO STANDBY
Locate the next track to be recorded during recording pause	CD PLAYER ◀◀/▶▶
Resume recording after pausing	CD-SYNCHRO START
Check the remaining recordable time on the MD	TIME on the deck (MDS-JE640) or DISPLAY (MDS-JE440) (page 17)

 You can use the remote of the CD player during CD Synchro-recording

Press	To change the deck to	And change the CD player to
▷	Recording	Play
■	Recording pause	Stop
	Recording pause	Pause

 During CD Synchro-recording, track numbers are marked in the following ways:

- When the CD player is connected to the DIGITAL IN connector, track numbers are automatically marked as they appear on the CD.
- When the CD player is connected to the ANALOG IN jacks, track numbers are automatically marked when "T.Mark Lsyn(c)" has been selected (page 19).
- When you resume recording after recording pause, a new track number is automatically marked, regardless of the track marking parameter setting ("T.Mark Lsyn(c)" or "T.Mark Off").

 You can change CDs during CD Synchro-recording

- 1 Press ■ on the CD player's remote.
- 2 Change the CD.
- 3 Press ▷ on the CD player's remote.
Recording resumes.

 You can also perform synchro-recording with a Sony video CD player

By reprogramming the MD's remote, you can use the procedure above to perform synchro-recording with a Sony video CD player.
Press number button 2 while pressing down I/⏏ on the MD deck's remote. You can now operate the MD deck and the video CD player with the remote. To control the CD player again, press number button 1 while pressing down I/⏏ on the MD deck's remote.

 During CD Synchro-recording, the deck copies CD text information (CD text and disc memos) as it is to the MD (Disc Memo Copy Function) (MDS-JE640 only)

The Disc Memo Copy Function operates when you make a CD Synchro-recording from a Sony CD player connected with a control AIII cable (not supplied) to the MD deck.

Notes

- When performing CD Synchro-recording with a CD player with a mode selector, be sure to set the selector to CD1.
- When you record tracks from certain CD or multi-disc players, the entire material may be recorded as a single track.
- The Disc Memo Copy Function may not operate for extremely short CD tracks (MDS-JE640 only).
- Text information may not be copied for some CDs (MDS-JE640 only).

Making a CD Synchro-recording from a Sony CD player connected with a control A1II cable (MDS-JE640 only)

- 1 Do steps 1 to 3 of “Synchro-recording with a Sony CD player” on page 21.**
- 2 Set the CD player to playing pause mode.**
- 3 Press ● on the deck.**
The MD deck changes to recording pause.
- 4 Press ▷ or II on the deck.**
The deck starts recording and the CD player starts to play. When CD play finishes, recording stops.

Playing MDs

This chapter explains the various ways to play MDs.

Playing an MD

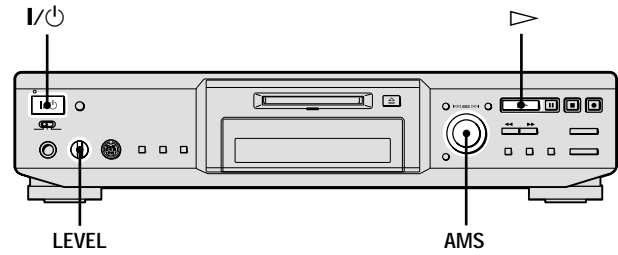

- 1 Turn on the amplifier and select MD on the amplifier.**
- 2 Press I/⏻ to turn on the deck.**
The STANDBY indicator turns off.
- 3 Insert an MD.**
- 4 If necessary, turn AMS (or press ►► repeatedly) to locate the track you want to start playing from.**
If you want to play from the first track, skip this step and go to step 5.
- 5 Press ▷.**
The deck starts to play.
- 6 Adjust the volume on the amplifier.**

Operations you may want to do during play

To	Press or turn
Stop play	■
Pause play	
Resume play after pausing	▷ or
Locate a succeeding track	AMS clockwise (or press ►► repeatedly)
Locate the beginning of the current track or a preceding track	AMS counterclockwise (or press ◀◀ repeatedly)
Eject the MD	⏏ after stopping play

💡 When you play an MD recorded in LP2 or LP4 Stereo mode

The MD LP indicator lights up when you press ▷ in step 5 above.

💡 (MDS-JE640 only) To use headphones

Connect them to the PHONES jack. Turn LEVEL to adjust the headphones level.

💡 (MDS-JE640 only) You can adjust the analog signal level output to the PHONES jack and the ANALOG OUT jacks

- 1** While the deck is playing, press LEVEL/DISPLAY/CHAR (or DISPLAY) repeatedly until the line output adjustment display appears.
- 2** Turn AMS (or press LEVEL +/- repeatedly) to adjust the output signal level.

💡 (MDS-JE640 only) You can use Setup Menu to adjust the analog output level

- 1 While the deck is playing, press MENU/NO twice. "Setup Menu" appears in the display.
- 2 Turn AMS (or press ◀▶/▶▶ repeatedly) until "Aout" appears, then press AMS or YES.
- 3 Turn AMS (or press LEVEL +/- repeatedly) to adjust the output signal level, then press AMS or YES.
- 4 Press MENU/NO.

Note

When you eject the MD or turn off the deck, the output level is reset to the factory setting (0.0 dB).

To change the display during playing

Press LEVEL/DISPLAY/CHAR (or DISPLAY) repeatedly to change the display.

Each press of the button changes the display as follows:

MDS-JE640

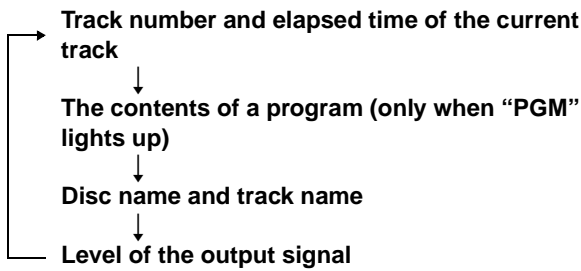

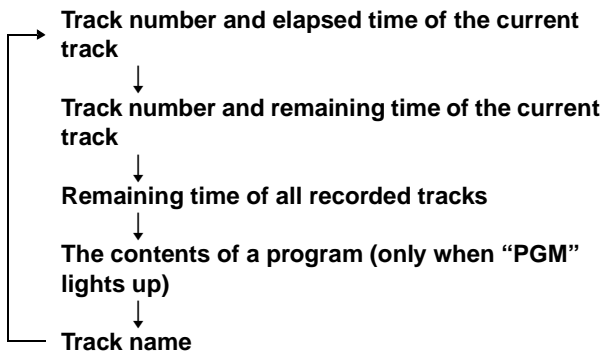

MDS-JE440

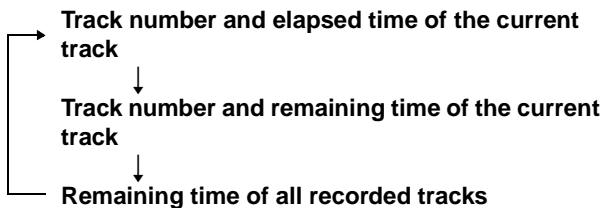

💡 You can check the remaining time

Press TIME during playback (MDS-JE640 only). Each press of the button changes the display as follows:



💡 You can check the track name while playing (only when the track name is recorded) 

Press SCROLL.

The track name appears and scrolls. While the track name is scrolling, press the button again to pause scrolling, and again to continue scrolling.

For MDS-JE440, you can also use SCROLL on the deck.

Playing a specific track

While the deck is playing or stopped, use the procedure below to quickly play any track.

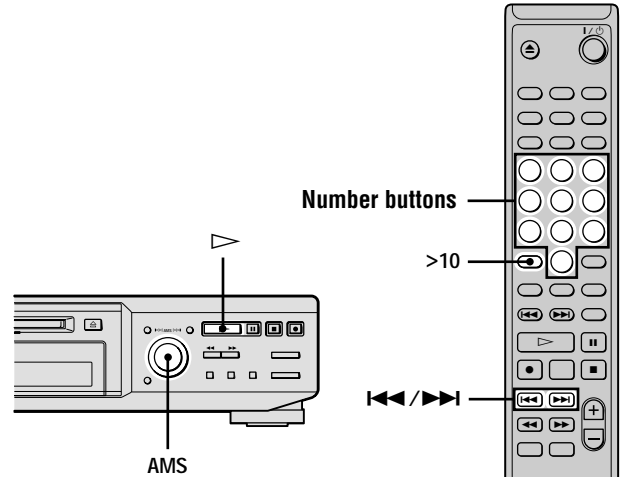

Locating a track with AMS¹⁾

To go to	Do the following:
The next or a succeeding track during play	Turn AMS clockwise (or press ▶▶ repeatedly).
A preceding track during play	Turn AMS counterclockwise (or press ◀◀ repeatedly).
The beginning of the current track during play	Turn AMS counterclockwise (or press ◀◀ once).
A specific track while the deck is stopped	Turn AMS (or press ◀▶/▶▶ repeatedly) until the track number you want to go to flashes in the display, then press AMS or ▷.

1) Automatic Music Sensor

💡 You can locate the last track of the MD quickly

While the deck is stopped, turn AMS counterclockwise (or press ◀◀ once).

💡 If you locate a track while the deck is stopped or paused

The deck will still be stopped or paused at the beginning of the located track.

Playing a track by entering the track number 

Press the number button(s) to enter the track number of the track you want to play.

To enter a track number over 10

- 1 Press >10.

2 Enter the corresponding digits.

To enter 0, press 10/0 instead.

Examples:

- To play track number 30, press >10, then 3 and 10/0.
- To play track number 108, press >10, then 1, 10/0, and 8.

💡 If you enter a track number while the deck is paused

The deck will still be paused at the beginning of the track.

Locating a particular point in a track

You can locate a particular point in a track during play or play pause.

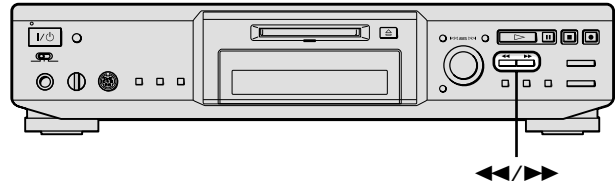

Locating a point while monitoring the sound

During play, press down ◀▶ until you reach the point you want.

You will hear intermittent playing as the disc goes forward or in reverse. When you reach the point you want, release the button.

Notes

- If the MD reaches the end while you're pressing ▶▶, the deck stops.
- Tracks that are only a few seconds long may be too short for monitoring. For such tracks, play the MD at normal speed.

Locating a point by observing the time indication

During play pause, press down ◀▶ until you reach the point you want.

When you reach the point you want, release the button. To start playing, press ▷ or ■■. No sound is output during this time.

💡 When “– Over –” appears in the display

The MD has reached the end while you're pressing ▶▶. Turn AMS counterclockwise (or press ◀◀) or press ◀▶ to go back.

Playing tracks repeatedly (Repeat Play)

You can play an entire MD repeatedly. This function can be used with Shuffle Play to repeat all the tracks in random order (page 27), or with Program Play to repeat all the tracks in the program you have created (page 27). You can also repeat a specific track or portion within a track.

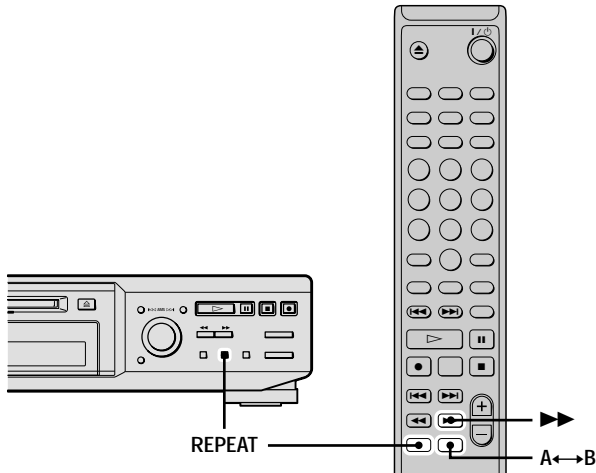

Note

If you turn off the deck or disconnect the AC power cord, the deck will store the last setting of the repeat play (“Repeat All” or “Repeat 1”) and recall it the next time you turn on the deck.

Repeating all the tracks on the MD (Repeat All Play)

Press REPEAT repeatedly until “Repeat All” appears in the display.

When you play an MD, the deck repeats the tracks as follows:

When the play mode is	The deck repeats
Normal play (page 23)	All the tracks in sequence
Shuffle Play (page 27)	All the tracks in random order
Program Play (page 27)	All the tracks in the program in sequence

To stop Repeat All Play

Press ■.

To resume normal play

Press REPEAT repeatedly until “Repeat Off” appears in the display.

Repeating the current track (Repeat 1 Play)

While the track you want to repeat is being played, press REPEAT repeatedly until “Repeat 1” appears in the display.

Repeat 1 Play starts.

To stop Repeat 1 Play

Press ■.

To resume normal play

Press REPEAT repeatedly until “Repeat Off” appears in the display.

Repeating a specific portion within a track (Repeat A-B Play)

You can specify one portion within a track to be played repeatedly. Note that the portion that you specify must be within the boundaries of a single track.

- 1 While the deck is playing, press A↔B at the starting point (point A) of the portion to be played repeatedly.
“REP A-” lights up and “B” flashes in the display.
- 2 Continue playing the track or press ►► to locate the ending point (point B), then press A↔B.
“REP A-B” lights up and Repeat A-B Play starts.

To stop Repeat A-B Play and resume normal play

Press REPEAT or CLEAR.

You can set a new starting point and ending point during Repeat A-B Play

You can change the current ending point to a new starting point, then specify a new ending point to repeat a portion right after the current portion.

- 1 During Repeat A-B Play, press A↔B.
The current ending point changes to the new starting point (point A).
“REP A-” lights up and “B” flashes in the display.
- 2 Locate the new ending point (point B) and press A↔B.
“REP A-B” lights up and the deck starts to repeat the newly specified portion.

Playing tracks in random order (Shuffle Play)

When you select Shuffle Play, the deck plays all the tracks on the MD in random order.

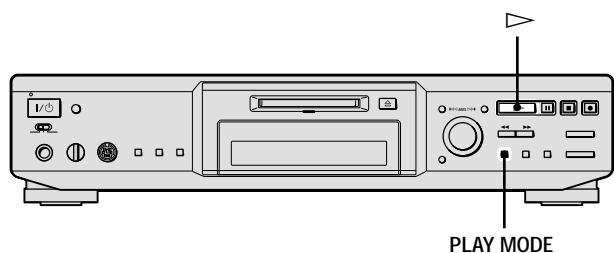

1 While the deck is stopped, press **PLAY MODE** repeatedly until “SHUF” lights up in the display.

2 Press .

Shuffle Play starts.



 appears while the deck is “shuffling” the tracks.

To resume normal play

While the deck is stopped, press **PLAY MODE** repeatedly until “SHUF” turns off.

You can locate tracks during Shuffle Play

Turn **AMS** (or press  repeatedly).



- To locate the next track or a later track to be played, turn **AMS** clockwise (or press  repeatedly).
- To locate the beginning of the current track, turn **AMS** counterclockwise (or press ). Note that you cannot locate and play the tracks that have already been played once.

Creating your own program (Program Play)

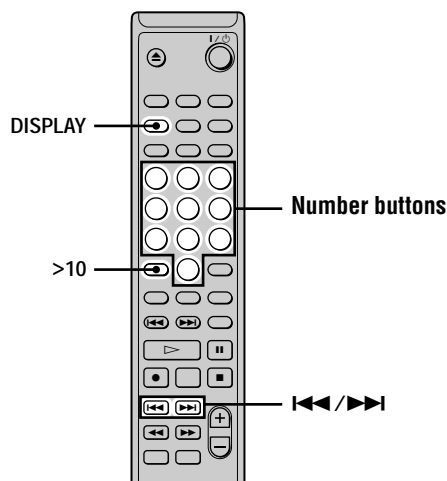
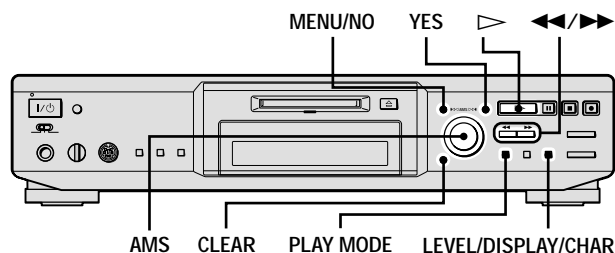

You can pick out the tracks that you like and specify the playing order in a program containing up to 25 tracks.



Programming the tracks

- 1** While the deck is stopped, press **MENU/NO** twice. “Setup Menu” appears in the display.
- 2** Turn **AMS** (or press  repeatedly) until “Program ?” appears, then press **AMS** or **YES**.
- 3** Turn **AMS** (or press  repeatedly) until the track number you want to add to the program appears, then press **AMS** or  (or use the number button(s) to enter the track directly).

If you entered the wrong track number

Press  repeatedly until the wrong track number flashes, then do step 3 above again or press **CLEAR** to erase the track number. If “0” flashes, press  so that the last track number flashes, then enter a correct number.

To enter a track number over 10

Use **>10**. For details, see page 24.

4 Repeat step 3 to enter other tracks.

The entered track is added to the location where the “0” flashes.

Each time you enter a track, the total program time appears in the display.

5 Press YES.

“Complete!!” appears and the program is completed.

6 Press PLAY MODE repeatedly until “PGM” lights up in the display.

7 Press ▷.

Program Play starts.

To stop Program Play

Press ■.

To resume normal play

Press PLAY MODE repeatedly until “PGM” turns off.

 **The program remains even after Program Play ends or is stopped**

Press ▷ to play the program again.

Notes

- If you eject the MD, the program will be lost.
- The display shows “- - . - -” when the total playing time of the program exceeds 999 minutes.
- “ProgramFull(1)” appears when you try to program the 26th track.

Checking the order of the program

While the deck is stopped and “PGM” lights up, press LEVEL/DISPLAY/CHAR (or DISPLAY) repeatedly.

The first several tracks in the program appear in the display. To see the rest of the program, turn AMS (or press ►► repeatedly).

Changing the contents of the program

While the deck is stopped and “PGM” lights up, do steps 1 and 2 of “Programing the tracks” on page 27, followed by one of the procedures below:

To	Do the following:
Erase a track	Press ◀◀/▶▶ repeatedly until the number of the unwanted track flashes, then press CLEAR.
Erase all tracks	Press down CLEAR until all the track numbers disappear.
Add a track at the beginning of the program	Press ◀◀ repeatedly until “0” flashes before the first track number, then do steps 3 to 5 of “Programing the tracks” on page 27.

To	Do the following:
Add a track in the middle of the program	Press ◀◀/▶▶ repeatedly until the track number which will precede the new track flashes. Press AMS to display flashing “0,” then do steps 3 to 5 of “Programing the tracks” on page 27.
Add a track to the end of the program	Press ▶▶ repeatedly until “0” flashes after the last track number, then do steps 3 to 5 of “Programing the tracks” on page 27.
Replace a track	Press ◀◀/▶▶ repeatedly until the number of the track to be changed flashes, then do steps 3 to 5 of “Programing the tracks” on page 27.

Tips for recording from MDs to tape (MDS-JE640 only)

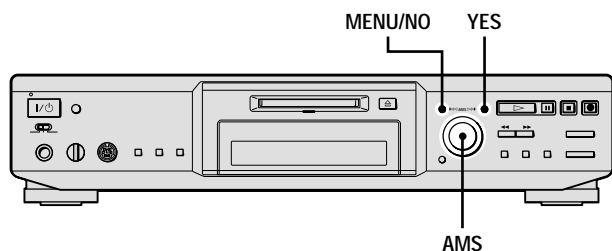

Inserting blanks between tracks during play (Auto Space)

The MD deck can be set to automatically insert a three-second blank between tracks during play. This function is useful when you're recording from an MD to an analog tape. The three-second blank enables you to use the Multi-AMS function later to locate the beginning of tracks on the tape.

- 1 While the deck is stopped, press **MENU/NO** twice. "Setup Menu" appears in the display.
- 2 Turn **AMS** (or press **◀◀/▶▶** repeatedly) until "Auto Off" appears, then press **AMS** or **YES**.
- 3 Turn **AMS** (or press **◀◀/▶▶** repeatedly) to select the setting, then press **AMS** or **YES**.

To	Select
Turn on Auto Space	Auto Space
Turn off Auto Space	Auto Off (factory setting)

- 4 Press **MENU/NO**.

💡 When you turn on Auto Space

"Auto Space" appears when the deck is inserting a blank between tracks.

Notes

- If you select "Auto Space" and record a selection containing multiple track numbers (for example, a medley or symphony), blank spaces will be created on the tape between the various sections.
- If you turn off the deck or disconnect the AC power cord, the deck will store the last setting ("Auto Space" or "Auto Off") and recall it the next time you turn on the deck.

Pausing after each track (Auto Pause)

You can set the MD deck so that it pauses after each track to give you time to locate the next track to be recorded.

- 1 While the deck is stopped, press **MENU/NO** twice. "Setup Menu" appears in the display.
- 2 Turn **AMS** (or press **◀◀/▶▶** repeatedly) until "Auto Off" appears, then press **AMS** or **YES**.

- 3 Turn **AMS** (or press **◀◀/▶▶** repeatedly) to select the setting, then press **AMS** or **YES**.

To	Select
Turn on Auto Pause	Auto Pause
Turn off Auto Pause	Auto Off (factory setting)

- 4 Press **MENU/NO**.

To resume play after pausing

Press **▶**.

💡 When you turn on Auto Pause

"Auto Pause" appears during pause and disappears when the deck resumes play.

Note

If you turn off the deck or disconnect the AC power cord, the deck will store the last setting ("Auto Pause" or "Auto Off") and recall it the next time you turn on the deck.

Editing Recorded MDs

This chapter explains how to edit the tracks that have been recorded to an MD.

Before you start editing

Brief descriptions of buttons and control used to edit MDs

The buttons and control below are used to erase, divide, move, or combine tracks on the MD.

Note

The operation of these buttons and the control is different when naming a track or MD. For details, see “Naming a track or MD” on page 35.

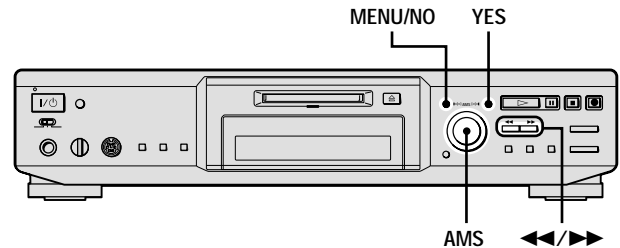

MENU/NO button: While the deck is stopped, playing, or paused, press to edit tracks. While editing, press to cancel editing.

AMS control: Turn to select an editing operation or track number, then press to enter your selection. You can also use the control to specify points in a track for erasure or track division.

YES button: Press this button instead of the AMS control to enter a selection.

◀◀/▶▶ buttons: Press to specify the unit (minute, second, or frame) by which the MD is advanced when the AMS control is turned. You can also use these buttons to locate the end point of the portion to be erased.

For further details on the function of each button and control, see the following sections on editing operations.

About indication which appears while editing

When “Protected” appears while editing

The record-protect slot is open. To edit the MD, slide the tab to close the slot. For details, see “To prevent accidental erasure of the recorded material” on page 14.

About indications which appear after editing

When “TOC” lights up in the display after editing

Editing has finished but the TOC (Table of Contents) on the MD has not been updated to reflect the editing results. The editing will be lost if you disconnect the AC power cord while the indication is on. The TOC will be updated only when you eject the MD or turn off the MD deck.

When “TOC Writing” flashes in the display

The deck is updating the TOC. Do not disconnect the AC power cord or move the deck while the indication flashes.

Erasing tracks (ERASE)

You can erase a track or part of a track by specifying the number of the track or the portion within a track to be erased. You can also erase all the tracks on an MD at one time.

Erasing a track

Specify the number of the track you want to erase.

Example: Erasing the second track (BBB)

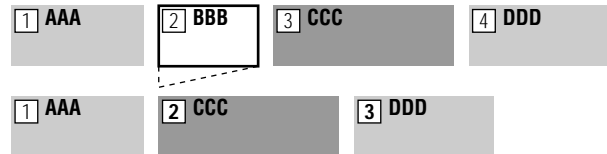

When you erase a track, all the tracks after the one erased are automatically renumbered. For example, if you erase track number 2, the previous track number 3 becomes track number 2 and the previous track number 4 becomes track number 3, and so on.

1 While the deck is stopped, playing, or paused, press MENU/NO.

“Edit Menu” appears in the display.

2 Turn AMS (or press I◀◀/▶▶I repeatedly) until “Tr Erase ?” appears, then press AMS or YES.

The deck starts to play the track indicated by the number in the display.

3 Turn AMS (or press I◀◀/▶▶I repeatedly) until the track number you want to erase appears.

4 Press AMS or YES.

“Complete!!” appears for a few seconds and the track is erased. The track following the erased track starts to play. If the erased track is the last one on the MD, the track preceding the erased track starts to play.

To cancel the operation

Press MENU/NO or ■.

💡 If “Erase ???” appears in step 4 above

The track has been record-protected on another MD deck. If you still want to erase the track, press AMS or YES again while the indication appears.

💡 To avoid confusion when erasing more than one track

Start erasing from the highest numbered track. This way you will avoid renumbering the tracks that you plan to erase.

Erasing all the tracks on an MD

Do the procedure below to erase all the tracks, track names, and disc name at once.

- 1 While the deck is stopped, playing, or paused, press MENU/NO.**
“Edit Menu” appears in the display.
- 2 Turn AMS (or press I◀◀/▶▶I repeatedly) until “All Erase ?” appears, then press AMS or YES.**
“All Erase ??” appears in the display.
- 3 Press AMS or YES.**
“Complete!!” appears for a few seconds and all the tracks, track names, and disc name are erased.

To cancel the operation

Press MENU/NO or ■.

Erasing a portion of a track

You can easily erase a portion of a track by specifying the starting and ending points of the erasure.

This is useful for erasing the unnecessary portions of a track recorded from a satellite or FM broadcast.

Example: Erasing portion “B2” of the second track

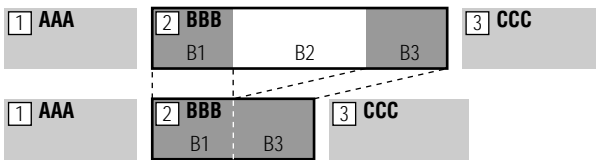

- 1 While the deck is stopped, playing, or paused, press MENU/NO.**
“Edit Menu” appears in the display.
- 2 Turn AMS (or press I◀◀/▶▶I repeatedly) until “A-B Erase ?” appears, then press AMS or YES.**
- 3 Turn AMS (or press I◀◀/▶▶I repeatedly) until the number of the track containing the portion to be erased appears, then press AMS or YES.**
“-Rehearsal-” and “Point A ok?” alternate in the display and the deck repeatedly plays several seconds of the track from the point AMS or YES was pressed.
- 4 While monitoring the sound, turn AMS (or press I◀◀/▶▶I repeatedly) to locate the starting point of the portion to be erased (point A).**
You can shift the starting point by 1-frame* intervals (1 frame = 1/86 second).
The time indication (minute, second, and frame) of the current point is displayed and the deck plays several seconds of the track to that point repeatedly.

* When recording in Stereo mode, you can shift the starting point by 2-frame intervals (in Monaural mode and LP2 Stereo mode) or by 4-frame intervals (in LP4 Stereo mode).

To find a point quickly

Specify a unit (minute, second, or frame) by which the MD is advanced when you turn AMS (or press I◀◀/▶▶I repeatedly).

To do this, press ◀◀/▶▶ in step 4 repeatedly to select minute, second, or frame. The selected unit flashes in the display.

5 Repeat step 4 until you have located point A.

6 Press AMS or YES to enter point A.

“Point B set” appears and the deck starts playing from point A until the track ends.

7 Continue playing the track or press ▶▶ to locate the ending point of the portion to be erased (point B), then press AMS or YES.

“A-B Ers” and “Point B ok?” alternate in the display and a few seconds of the track before point A and after point B play back repeatedly.

8 Repeat step 4 until you have located point B.

9 Press AMS or YES to enter point B.

“Complete!!” appears for a few seconds and the portion between point A and B is erased.

To cancel the operation

Press MENU/NO or ■.

Note

If “Impossible” appears in the display, you cannot erase a portion of a track. This happens when you have edited the same track many times.

This is due to a technical limitation of the MD system and is not a mechanical error.

Dividing tracks (DIVIDE)

You can divide a recorded track at any point by adding a track mark at that point. This is especially useful when you want to divide recorded material that contains multiple tracks but only one track number, or when you want to be able to locate a certain point in the track.

Example: Dividing the second track

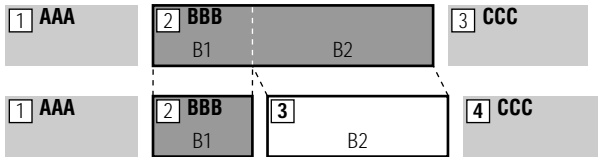

When you divide a track, the total number of tracks increases by one and all tracks following the divided track are automatically renumbered.

Dividing a track after selecting the track

- 1 While the deck is stopped, playing, or paused, press MENU/NO.**
“Edit Menu” appears in the display.
- 2 Turn AMS (or press ◀▶ repeatedly) until “Divide ?” appears, then press AMS or YES.**
- 3 Turn AMS (or press ◀▶ repeatedly) until the number of the track you want to divide appears, then press AMS or YES.**
“-Rehearsal-” appears and the deck repeatedly plays several seconds of the track from the point AMS or YES was pressed.
- 4 While monitoring the sound, turn AMS (or press ◀▶ repeatedly) to locate the dividing point.**
You can shift the starting point by 1-frame* intervals (1 frame = 1/86 second).
The time indication (minute, second, and frame) of the current point is displayed and the deck plays several seconds of the track to that point repeatedly.
* When recording in Stereo mode, you can shift the starting point by 2-frame intervals (in Monaural mode and LP2 Stereo mode) or by 4-frame intervals (in LP4 Stereo mode).
To find a point quickly
Specify a unit (minute, second, or frame) by which the MD is advanced when you turn AMS (or press ◀▶ repeatedly).
To do this, press ◀▶ in step 4 repeatedly to select minute, second, or frame. The selected unit flashes in the display.
- 5 Repeat step 4 until you have located the dividing point.**

- 6 Press AMS or YES.**

“Complete!!” appears for a few seconds and the track is divided. The deck starts to play the newly created track. Note that new track has no name.

To cancel the operation

Press MENU/NO or ■.

💡 You can divide tracks while recording

For details, see “Marking track numbers while recording” on page 19.

Dividing a track after selecting the dividing point

- 1 While the deck is playing, press AMS at the point you want to divide the track.**
“- Divide -” and “-Rehearsal-” alternate in the display and the deck starts to play from the selected point repeatedly.
- 2 If necessary, do step 4 of “Dividing a track after selecting the track” on page 33 to finely adjust the dividing point.**
- 3 Press YES.**
“Complete!!” appears for a few seconds and the track is divided. The deck starts to play the newly created track. Note that new track has no name.

To cancel the operation

Press MENU/NO or ■.

💡 You can divide tracks while recording

For details, see “Marking track numbers while recording” on page 19.

Combining tracks (COMBINE)

This function allows you to combine any two tracks into a single track. The two tracks need not to be consecutive nor chronological. You can combine several tracks into a single medley, or several independently recorded portions into a single track. When you combine two tracks, the total number of tracks decreases by one and all tracks following the combined track are renumbered. You can also use this function when you want to delete unnecessary track numbers.

Example: Combining the second track and the fourth track

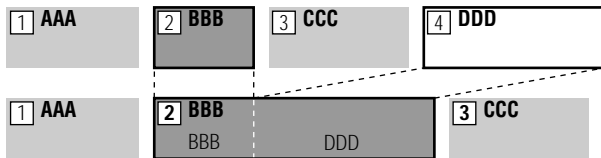

If both of the combined tracks have a track name, the name of the second track is erased.

- 1 While the deck is stopped, playing, or paused, press MENU/NO.
“Edit Menu” appears in the display.
- 2 Turn AMS (or press ◀▶/▶▶) repeatedly until “Combine ?” appears, then press AMS or YES.
- 3 Turn AMS (or press ◀▶/▶▶) repeatedly until the number of the first track of the two to be combined appears, then press AMS or YES.
The display for selecting a second track appears and the deck plays the portion where joining will occur (the end of the first track and the beginning of the second track following it) repeatedly.
- 4 Turn AMS (or press ◀▶/▶▶) repeatedly until the number of the second track of the two to be combined appears, then press AMS or YES.
“Complete!!” appears for a few seconds and the tracks are combined. The deck starts to play the combined track.

To cancel the operation

Press MENU/NO or ■.

Notes

- Tracks recorded in different modes (stereo, MONO, LP2 or LP4) cannot be combined.
- If “Impossible” appears in the display, the tracks cannot be combined because repeated editing has been done to the track(s). This is a technical limitation of the MD system and is not a mechanical error.

Moving tracks (MOVE)

This function lets you change the order of any track.

Example: Moving the second track after the third track

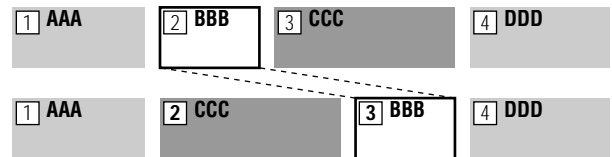

After you move a track, the tracks are renumbered automatically.

- 1 While the deck is stopped, playing, or paused, press MENU/NO.
“Edit Menu” appears in the display.
- 2 Turn AMS (or press ◀▶/▶▶) repeatedly until “Move ?” appears, then press AMS or YES.
- 3 Turn AMS (or press ◀▶/▶▶) repeatedly until the number of the track to be moved appears, then press AMS or YES.
- 4 Turn AMS (or press ◀▶/▶▶) repeatedly until the new track position appears, then press AMS or YES.
“Complete!!” appears for a few seconds and the track is moved. The deck starts to play the moved track.

To cancel the operation

Press MENU/NO or ■.

Naming a track or MD (NAME)

You can enter a name for a recorded MD as well as for individual tracks. Names can consist of uppercase and lowercase letters, numbers, and symbols. A total number of about 1,700 characters can be stored for all the names on the MD.

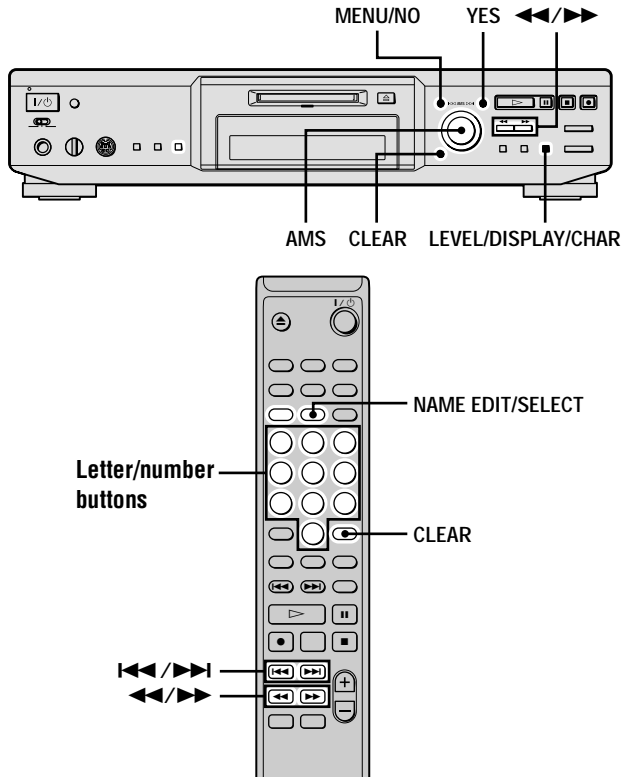

Note

If you name a track while it is being recorded, be sure to finish the naming operation before the track ends. If the track ends before you finish, the entered character data will be discarded and the track will remain unnamed. Also, you cannot name tracks while the deck is recording over existing material.

Naming a track or an MD using the controls on the deck

1 Press MENU/NO while the deck is in one of the operating modes listed below, depending on what you want to name:

To name	Press while the deck is
A track or the MD	Stopped, playing, or paused
The track being recorded	Recording the track

“Edit Menu” appears in the display.

To enter a name while the deck is recording, go to step 3.

2 Turn AMS until “Name ?” appears, then press AMS or YES.

3 Turn AMS until “Nm In ?” appears, then press AMS or YES.

While the deck is recording, a flashing cursor appears in the display and you can enter a name for the track being recorded. In this case, go to step 5.

4 Turn AMS until the track number (when naming a track) or “Disc” (when naming the MD) flashes, then press AMS or YES.

A flashing cursor appears.

The deck starts playing and you can name a track while monitoring the sound.



5 Press LEVEL/DISPLAY/CHAR repeatedly to select the character type.

To select	Press repeatedly until
Uppercase letters	“A” appears in the display
Lowercase letters	“a” appears in the display
Numbers	“0” appears in the display
Symbols ¹⁾	“ ” appears in the display

1) You can use the following symbols in titles:
' - / , . () : ! ? & + < > _ = " ; # \$ % @ * `

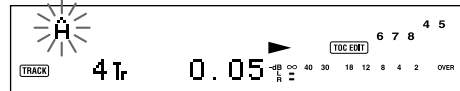

To enter a space

Press ►► while the cursor is flashing. You cannot enter a space as the first character.

6 Turn AMS to select the character.

The selected character flashes.



To change a selected character

Repeat steps 5 and 6.

7 Press AMS.

The selected character is entered and lights continuously. The cursor shifts to the right, flashes, and waits for the input of the next character.



8 Repeat steps 5 to 7 to enter the rest of the name.

To change a character

Press ◀◀/▶▶ repeatedly until the character to be changed flashes, then repeat steps 5 to 7.

To erase a character

Press ◀◀/▶▶ repeatedly until the character to be erased flashes, then press CLEAR.

9 Press YES.

The whole name appears in the display, followed by “Complete!!” to indicate that the labeling procedure is completed.

To cancel the operation

Press MENU/NO or ■.

Naming a track or an MD using the remote **1 Press NAME EDIT/SELECT while the deck is in one of the operating modes listed below, depending on what you want to name:**

To name	Press while the deck is
A track	Playing, paused, recording, or stopped with the track number displayed
The MD	Stopped with total number of tracks displayed

A flashing cursor appears in the display.

2 Press NAME EDIT/SELECT repeatedly to select the character type.

To select	Press repeatedly until
Uppercase letters and symbols ¹⁾	“Selected AB(C)” appears in the display
Lowercase letters and symbols ¹⁾	“Selected ab(c)” appears in the display
Numbers	“Selected 12(3)” appears in the display

1) Only ‘-/, . () : ! ? can be selected.

3 Enter a character using letter/number buttons.**If you have selected uppercase or lowercase letters**

1 Press the corresponding letter/number button repeatedly until the character to be entered flashes.

Or, press the button once and press ◀◀/▶▶ repeatedly.

To select symbols, press ◀◀ repeatedly while “A” is flashing.

2 Press ▶▶.

The flashing character is entered and lights continuously and the cursor shifts to the right.

If you have selected numbers

Press the corresponding number button.

The number is entered and the cursor shifts to the right.

4 Repeat steps 2 and 3 to enter the rest of the name.**To change a character**

Press ◀◀/▶▶ repeatedly until the character to be changed flashes, press CLEAR to erase the character, then repeat steps 2 and 3.

5 Press YES.

The whole name appears in the display, followed by “Complete!!” to indicate that the labeling procedure is completed.

To cancel the operation

Press MENU/NO or ■.

Copying a track or disc name

You can copy an existing track or disc name and use it to name another track on the same disc or the disc itself.

1 While the deck is stopped, playing, or paused, press MENU/NO.

“Edit Menu” appears in the display.

2 Turn AMS (or press ◀◀/▶▶ repeatedly) until “Name ?” appears, then press AMS or YES.**3 Turn AMS (or press ◀◀/▶▶ repeatedly) until “Nm Copy ?” appears, then press AMS or YES.****4 Turn AMS (or press ◀◀/▶▶ repeatedly) until the track number (when copying the track name) or “Disc” (when copying the disc name) flashes, then press AMS or YES to copy the selected name.****When “No Name” appears in the display**

The selected track or disc has no name.

5 Turn AMS (or press ◀◀/▶▶ repeatedly) until the track number (when naming a track) or “Disc” (when naming a disc) flashes, then press AMS or YES to enter the copied name.

“Complete!!” appears for a few seconds and the name is copied.

To cancel the operation

Press MENU/NO or ■.

 When “Overwrite ?(?)” appears in step 5 above

The track or the disc selected in step 5 already has a name. If you wish to replace the name, press AMS or YES again while the indication appears in the display.

Renaming a track or MD **1 Press NAME EDIT/SELECT while the deck is in one of the operating modes listed below, depending on what you want to rename:**

To rename	Press while the deck is
A track	Playing, paused, recording, or stopped with the track number displayed
The MD	Stopped with total number of tracks displayed

A track or disc name appears in the display.

2 Press down CLEAR until the selected name is erased completely.

3 Do steps 5 to 8 of “Naming a track or an MD using the controls on the deck” on page 35 or steps 2 to 4 of “Naming a track or an MD using the remote” on page 36.

4 Press YES.

The whole name appears in the display, followed by “Complete!!” to indicate that the labeling procedure is completed.

Erasing a track or disc name

Use this function to erase the name of a track or disc.

1 While the deck is stopped, playing, recording, or paused, press MENU/NO.

“Edit Menu” appears in the display.

2 Turn AMS (or press ◀▶ repeatedly) until “Name ?” appears, then press AMS or YES.

3 Turn AMS (or press ◀▶ repeatedly) until “Nm Erase ?” appears, then press AMS or YES.

4 Turn AMS (or press ◀▶ repeatedly) until the number of the track (when erasing the track name) or “Disc” (when erasing the disc name) flashes, then press AMS or YES.

“Complete!!” appears for a few seconds and the name is erased.

To cancel the operation

Press MENU/NO or ■.

Erasing all the names on the MD

You can erase all the track names and the disc name on an MD in a single operation.

1 While the deck is stopped, playing, or paused, press MENU/NO.

“Edit Menu” appears in the display.

2 Turn AMS (or press ◀▶ repeatedly) until “Name ?” appears, then press AMS or YES.

3 Turn AMS (or press ◀▶ repeatedly) until “Nm All Ers?” appears, then press AMS or YES.

“Nm All Ers??” appears in the display.

4 Press AMS or YES.

“Complete!!” appears for a few seconds and all the names on the MD are erased.

To cancel the operation

Press MENU/NO or ■.

 You can erase all the recorded tracks and names on the MD

For details, see “Erasing all the tracks on an MD” on page 32.

Changing the recorded level after recording (S.F EDIT)

You can change the volume of recorded tracks using S.F (Scale Factor) Edit. The original track is recorded over at the new recording level. When changing the recording level, you can select Fade-in Recording to gradually increase the signal level at the start of recording, or Fade-out Recording to gradually decrease the signal level at the end of recording.

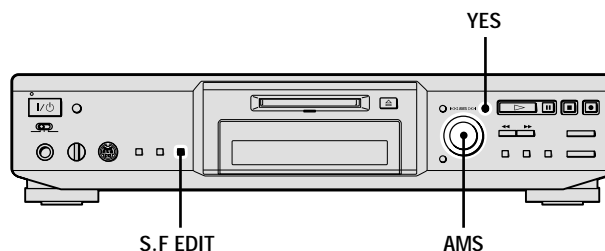

Changing the overall recording level

1 For MDS-JE640, press S.F EDIT.

“S.F Edit” appears in the display.

For MDS-JE440, do the following:

1 Press MENU/NO.

“Edit Menu” appears in the display.

2 Turn AMS (or press ◀▶ repeatedly) until “S.F Edit?” appears, then press AMS or YES.

2 Turn AMS (or press ◀▶ repeatedly) until “Tr Level ?” appears, then press AMS or YES.

3 Turn AMS (or press ◀▶ repeatedly) until the track number you want to change the recording level appears, then press AMS or YES.

“Level 0dB” appears in the display.

4 MDS-JE640

While monitoring the sound, turn AMS (or press ◀▶ repeatedly) to change the recorded level without turning on the two rightmost indicators on the peak level meters.

You can set the level at any value between -12 dB and +12 dB, in 2 dB increments.

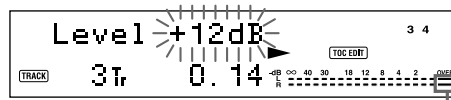

Avoid turning on these indicators

MDS-JE440

While monitoring the sound, turn AMS (or press **◀◀/▶▶** repeatedly) to change the recorded level without turning on “OVER” on the peak level meters.

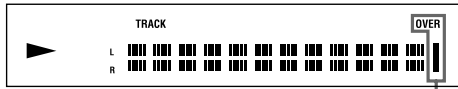

Avoid turning on these indicators

5 Press AMS or YES.

“(S.F) Edit OK?” appears in the display.

6 Press AMS or YES.

The deck starts recording over the existing track. “S.F Edit(:) ** %” appears while the track is being recorded. An amount of time that is roughly equal to or longer than the playback time of the track is required when recording over the track. When the recording finishes, “Complete!!” appears in the display for a few seconds.

Fade-in and Fade-out Recording**1 For MDS-JE640, press S.F EDIT.**

“S.F Edit” appears in the display.

For MDS-JE440, do the following:

1 Press MENU/NO.

“Edit Menu” appears in the display.

2 Turn AMS (or press ◀◀/▶▶ repeatedly) until “S.F Edit?” appears, then press AMS or YES.**2 Turn AMS (or press ◀◀/▶▶ repeatedly) until “Fade In ?” or “Fade Out ?” appears, then press AMS or YES.****3 Turn AMS (or press ◀◀/▶▶ repeatedly) until the track number you want to change the recording level appears, then press AMS or YES.**

“Time 5.0s” appears in the display.

4 While monitoring the sound, turn AMS (or press ◀◀/▶▶ repeatedly) to change the Fade-in or Fade-out Recording time.

The deck plays the portion that will be recorded over using Fade-in or Fade-out Recording.

You can set the time at any value between 1 second and 15 seconds, in 0.1 second increments. You cannot set the time longer than the track.

5 Press AMS or YES.

“(S.F) Edit OK?” appears in the display.

6 Press AMS or YES.

The deck starts recording over the existing track. “S.F Edit(:) ** %” appears while the track is being recorded. When the recording finishes, “Complete!!” appears in the display for a few seconds.

To cancel the operation

Press MENU/NO or **■** in steps 1 to 5. If you press AMS or YES in step 6 and recording starts, you cannot interrupt the operation.

💡 (For MDS-JE640) You can use Edit Menu to perform S.F Edit**1 While the deck is stopped, press MENU/NO.**

“Edit Menu” appears in the display.

2 Turn AMS (or press ◀◀/▶▶ repeatedly) until “S.F Edit?” appears, then press AMS or YES.**3 Turn AMS (or press ◀◀/▶▶ repeatedly) until “Tr Level ?,” “Fade In ?,” or “Fade Out ?” appears, then press AMS or YES.****4 Turn AMS (or press ◀◀/▶▶ repeatedly) to adjust the recording level or Fade-in or Fade-out Recording time.****5 Press AMS or YES.****Notes**

- **Do not disconnect the AC power cord or move the deck while recording is in progress. This may damage the recording data preventing recording from being performed properly.**
- You cannot change the recorded level of a track recorded in LP2 or LP4 Stereo mode.
- Do not use an MD that is damaged or dirty. This may prevent recording data from being recorded properly.
- Repeatedly changing the recording level results in poor sound quality.
- The recording level will not return to the exact original level once the recording level has been changed even if it returned to the original level.
- The recording level cannot be changed while the timer is activated.

Undoing the last edit (UNDO)

You can undo the last edit operation and restore the contents of the MD to the condition that existed before the operation. Note, however, that you cannot undo an edit operation if you perform any of the following operations after the edit:

- Start recording.
- Press MUSIC SYNC on the remote.
- Change the recorded level after recording (S.F Edit).
- Turn off the deck or eject the MD.
- Disconnect the AC power cord.

1 While the deck is stopped and no track number appears in the display, press MENU/NO.

“Edit Menu” appears in the display.

2 Turn AMS (or press ◀◀/▶▶ repeatedly) until “Undo ?” appears.

“Undo ?” does not appear if no editing has been done.

3 Press AMS or YES.

One of the following messages appears depending on the last edit operation.

Last edit operation	Message
Erasing a track	Erase Undo?
Erasing all the tracks on an MD	
Erasing a portion of a track	
Dividing a track	Divide Undo?
Combining tracks	Combin(e)Undo?
Moving a track	Move Undo?
Naming a track or MD	Name Undo?
Copying a track or disc name	
Renaming a track or MD	
Erasing a track or disc name	
Erasing all the names on the MD	

4 Press AMS or YES.

“Complete!!” appears for a few seconds and the MD is restored to the condition that existed before the edit operation.

To restore your edit

Press MENU/NO or ■.

Other Functions

This chapter explains other useful functions that are available on the MD deck.

Changing the pitch (Pitch Control Function) (MDS-JE640 only)

You can change the MD playing speed (pitch) when, for example, you enjoy Karaoke. The tone rises at higher pitches, and falls at lower pitches.

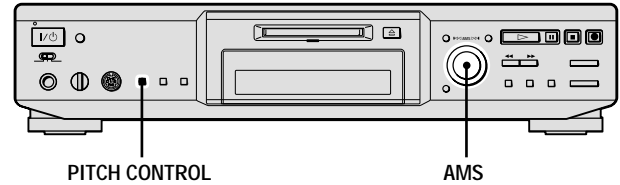

Setting the pitch automatically in steps (Auto Step Control Function)

You can lower the pitch by up to 36 steps¹⁾.

1) One octave equals 12 steps.

- 1 While the deck is playing, press **PITCH CONTROL** repeatedly until "Pitch" appears in the display.
- 2 Turn **AMS** (or press **◀◀/▶▶**) repeatedly until the desired step value appears.

To recall the factory setting

Press **CLEAR** while setting the value.

Notes

- When you change the step value, the playing sound drops out momentarily.
- The step value returns to "0" (factory setting) when you turn off the deck or eject the MD.
- When a dot (.) appears to the right of the step value in the pitch display, this indicates that you have performed fine adjustment (see page 40) and the pitch value is between steps. (The step and fine control values are linked.)

Pitch -12.

Finely controlling the pitch (Fine Control Function)

You can fine control the playing speed in 0.1% increments from -87.5% to 0.0%.

- 1 While the deck is playing, press **PITCH CONTROL** repeatedly until "Pfine" appears in the display.
- 2 Turn **AMS** (or press **◀◀/▶▶**) repeatedly until the desired step value appears.

To recall the factory setting

Press CLEAR while setting the value.

You can use Setup Menu to change the pitch

- 1 While the deck is playing, press MENU/NO twice. “Setup Menu” appears in the display.
- 2 Turn AMS (or press ◀◀/▶▶ repeatedly) until “Pitch” or “Pfine” appears, then press AMS or YES.
- 3 Turn AMS (or press ◀◀/▶▶ repeatedly) to adjust the pitch, then press AMS or YES.
- 4 Press MENU/NO.

Notes

- The playing sound drops out momentarily when you change the fine control value.
- The fine control value reverts to “0.0%” (factory setting) when you turn off the deck or eject the MD.
- The step and fine control values are linked; changing one value also changes the other.

Fading in and fading out

You can use Fade-in Play to gradually increase the signal level to the ANALOG OUT jacks and the PHONES jack (MDS-JE640 only) at the start of playing. Fade-out Play gradually decreases the signal level at the end of playing. Fade-in Recording gradually increases the signal level at the start of recording. Fade-out Recording gradually decreases the signal level at the end of recording.

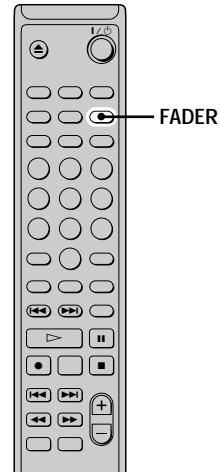

Note

The level of the signal output from the DIGITAL OUT connector does not change during Fade-in Play nor Fade-out Play.

Fade-in Play and Fade-in Recording

During play pause (for Fade-in Play) or recording pause (for Fade-in Recording), press FADER.

◀ flashes in the display and the deck performs Fade-in Play or Fade-in Recording for five seconds (factory setting) until the counter reaches “0.0s.”

Fade-out Play and Fade-out Recording

During play (for Fade-out Play) or recording (for Fade-out Recording), press FADER.

▶ flashes in the display and the deck performs Fade-out Play or Fade-out Recording for five seconds (factory setting) until the counter reaches “0.0s,” then pauses.

You can change the duration of Fade-in and Fade-out Play/Recording

- 1 While the deck is stopped, press MENU/NO twice. “Setup Menu” appears in the display.
- 2 Turn AMS (or press **◀◀/▶▶** repeatedly) to select the setting, then press AMS or YES.

To change the duration of	Select
Fade-in Play/Recording	F.in
Fade-out Play/Recording	F.out

- 3 Turn AMS (or press **◀◀/▶▶** repeatedly) to select the duration, then press AMS or YES.
Both the Fade-in and Fade-out durations can be set in 0.1 second steps.
- 4 Press MENU/NO.

Falling asleep to music (Sleep Timer)

You can set the deck so that it turns off automatically after a specified duration.

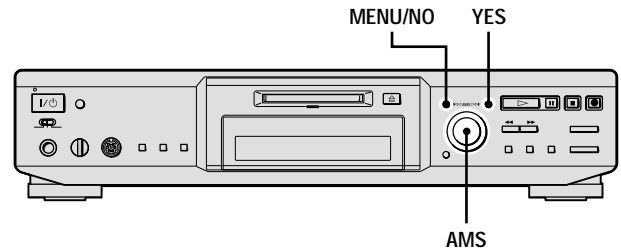

- 1 While the deck is stopped, press MENU/NO twice. “Setup Menu” appears in the display.
- 2 Turn AMS (or press **◀◀/▶▶** repeatedly) until “Sleep Off” appears in the display, then press AMS or YES.
- 3 Turn AMS (or press **◀◀/▶▶** repeatedly) to select the setting, then press AMS or YES.

To	Select
Turn on Sleep Timer	Sleep On ¹⁾
Turn off Sleep Timer	Sleep Off (factory setting)

1) For MDS-JE440, the deck turns off automatically after 60 minutes.

For MDS-JE640, do the following.

- 4 Turn AMS (or press **◀◀/▶▶** repeatedly) until “Sleep 60min” appears in the display, then press AMS or YES.
- 5 Turn AMS (or press **◀◀/▶▶** repeatedly) to select the time to be turned off (“30min,” “60min” (factory setting), “90min,” or “120min”), then press AMS or YES.
- 6 Press MENU/NO.

To turn off Sleep Timer

Repeat the procedure above, selecting “Sleep Off” in step 3.

You can check the remaining time

Once you turn on Sleep Timer, the remaining time is displayed when you select “Sleep” in Setup Menu.

Using a timer (MDS-JE640 only)

By connecting a timer (not supplied) to the deck, you can start and stop playing/recording operations at specified times. For further information on connecting the timer or setting the starting and ending times, refer to the instructions that came with the timer.

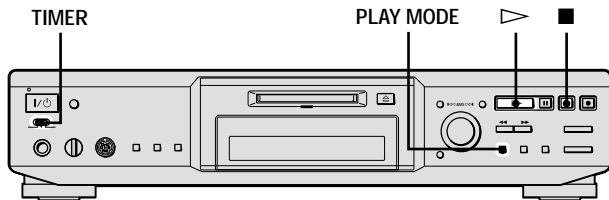

Playing an MD using a timer

1 Do steps 1 to 3 of “Playing an MD” on page 23.

2 Press **PLAY MODE** repeatedly to select the play mode you want.

To play only specific tracks, create a program (see page 27).

To specify the time for the end of playing, press \triangleright to start playing, then go to step 3.

3 Set **TIMER** on the deck to **PLAY**.

4 Set the timer as required.

- When you have set the time for the start of playing, the deck turns off. When the specified time arrives, the deck turns on and starts playing.
- When you have set the time for the end of playing, play continues. When the specified time arrives, the deck stops playing and turns off.
- When you have set the time for both the start and end of playing, the deck turns off. When the starting time arrives, the deck turns on and starts playing. When the ending time arrives, the deck stops playing and turns off.

5 After you have finished using the timer, set **TIMER** on the deck to **OFF**.

Recording to an MD using a timer

1 Do the following steps of “Recording to an MD” on page 13 according to how you want to use the timer.

To specify the time for	Do
The start of recording	Steps 1 to 6, then press \blacksquare
The end of recording	Steps 1 to 9
Both start and end of recording	Steps 1 to 6, then press \blacksquare

2 Set **TIMER** on the deck to **REC**.

3 Set the timer as required.

- When you have set the time for the start of recording, the deck turns off. When the specified time arrives, the deck turns on and starts recording.
- When you have set the time for the end of recording, recording continues. When the specified time arrives, the deck stops recording and turns off.
- When you have set the time for both the start and end of recording, the deck turns off. When the starting time arrives, the deck turns on and starts recording. When the ending time arrives, the deck stops recording and turns off.

4 After you have finished using the timer, set **TIMER** on the deck to **OFF**. Then change the deck to standby mode by plugging the AC power cord of the deck into a wall outlet or set the timer to continuous operation.

- If **TIMER** is left at **REC**, the deck will automatically start recording the next time you turn on the deck.
- If you do not change the deck to standby mode for more than a week after timer recording has finished, the recorded contents may disappear.

Make sure to change the deck to standby mode within a week after timer recording is completed.

The TOC on the MD is updated and recorded contents are written to the MD when you turn on the deck. If the recorded contents have disappeared, “Initialize” flashes when you turn on the deck.

Notes

- It may take about 30 seconds after the deck is turned on until recording starts. When recording at a specified time using the timer, be sure to take this time into account when setting the recording start time.
- During timer recording, new material is recorded from the end of the recorded portion on the MD.
- Material recorded during timer recording will be saved to the disc the next time you turn on the deck. “TOC Writing” will flash in the display at that time. Do not disconnect the AC power cord or move the deck while the indication flashes.
- Timer recording will stop if the disc becomes full.

Using the CONTROL A1II control system (MDS-JE640 only)

This MD deck is compatible with the CONTROL A1II Control System.

The CONTROL A1II control system was designed to simplify the operation of audio systems composed of separate Sony components. CONTROL A1II connections provide a path for the transmission of control signals that enable automatic operation and control features usually associated with integrated systems.

Currently, CONTROL A1II connections between a Sony MD deck, CD player, amplifier (receiver), and cassette deck provide automatic function selection and synchronized recording.

In the future the CONTROL A1II connection will work as a multifunction bus allowing you to control various functions for each component.

Note

The CONTROL A1II control system is designed to maintain upward compatibility as the control system is upgraded to handle new functions. In this case, however, older components will not be compatible with the new functions.

CONTROL A1II and CONTROL A1 compatibility

The CONTROL A1 control system has been updated to the CONTROL A1II which is the standard system in the Sony 300 disc CD changer and other recent Sony components. Components with CONTROL A1 jacks are compatible with components with CONTROL A1II, and can be connected to each other. Basically, the majority of the functions available with the CONTROL A1 control system will be available with the CONTROL A1II control system. However, when making connections between components with CONTROL A1 jacks and components with CONTROL A1II jacks, the number of functions that can be controlled may be limited depending on the component. For detailed information, refer to the operating instructions supplied with the component(s).

Connecting the CONTROL A1II control system

Connect monaural (2P) mini-plug cables in series to the CONTROL A1II jacks on the back of each component. You can connect up to ten CONTROL A1II compatible components in any order. However, you can connect only one of each type of component (i.e., 1 CD player, 1 MD deck, 1 tape deck and 1 receiver). (You may be able to connect more than one CD player or MD deck, depending on the model. Refer to the operating instructions supplied with the respective component for details.)

Example

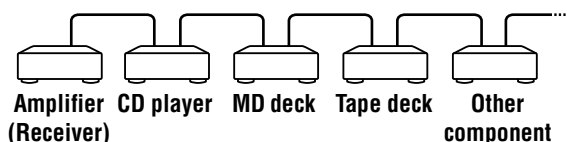

In the CONTROL A1II control system, the control signals flow both ways, so there is no distinction of IN and OUT jacks. If a component has more than one CONTROL A1II jack, you can use either one, or connect different components to each jack.

About the connecting cable

When a CONTROL A1II compatible component is not supplied with a connecting cable, use a commercially available monaural (2P) mini-plug cable less than 2 meters (6.6 feet) long, with no resistance (such as the Sony RK-G69HG).

Basic functions of the CONTROL A1II control system

Automatic function selection



When you connect CONTROL A1II compatible Sony components using CONTROL A1II cables (not supplied), the function selector on the amplifier (or receiver) automatically switches to the correct input when you press the play button on one of the connected components. (For example, when you press \triangleright (play button) on the MD deck while the CD is playing, the function selector on the amplifier switches from CD to MD.)

Notes

- This function works only when the components are connected to the amplifier (or receiver) inputs according to the names on the function buttons. Certain receivers allow you to switch the names of the function buttons. In this case, refer to the operating instructions supplied with the receiver.
- When recording, do not play any components other than the recording source. It will cause the automatic function selection to operate.

Synchronized recording

This function lets you conduct synchronized recording between the MD deck and selected source component.

- 1 Set the source selector on the amplifier (or receiver) to the source component.**
- 2 Set the source component to playing pause mode (make sure both the  and  indicators light together).**
- 3 Set the deck to recording pause mode.**
- 4 Press  on the deck.**

The source component is automatically released from pause mode, and recording begins shortly thereafter. When play ends from the source component, recording stops.

You can use a special synchronized recording

This MD deck is equipped with a special synchronized recording function that uses the CONTROL A1II Control System (see “Making a CD Synchro-recording from a Sony CD player connected with a control A1II cable (MDS-JE640 only)” on page 22).

Note

Do not set more than one component to the pause mode.

Operating the MD Deck Using a Keyboard (MDS-JE640 only)

This chapter explains simple ways to name a track or MD using an optional keyboard, as well as how to operate the MD deck directly using the keyboard.

Setting the keyboard

You can use any IBM¹⁾-compatible keyboard²⁾ with a PS/2 interface. You can select a keyboard with either an English or Japanese keyboard layout. When you use a keyboard with a different layout, you need to assign characters to the keys. For details, see “Assigning characters to keyboard keys” on page 48.

- 1) IBM is the registered trademark of International Business Machines Corporation.
- 2) Power consumption must be 120 mA or less.

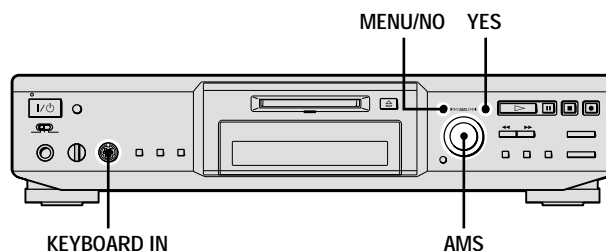

Connecting a keyboard to the MD deck

Connect the keyboard connector to the **KEYBOARD IN** jack on the front panel of the deck.

You can connect or disconnect the keyboard at any time regardless of whether the deck is turned on or off.

Selecting keyboard type

The first time you connect a keyboard, you need to select the keyboard type.

- 1 While the deck is stopped, press **MENU/NO** twice.
“Setup Menu” appears in the display.
- 2 Turn **AMS** (or press **◀◀/▶▶** repeatedly) until “Keyboard ?” appears, then press **AMS** or **YES**.
- 3 Turn **AMS** (or press **◀◀/▶▶** repeatedly) until “Type” appears, then press **AMS** or **YES**.
- 4 Turn **AMS** (or press **◀◀/▶▶** repeatedly) to select the setting, then press **AMS** or **YES**.

To use the keyboard with	Select
English keyboard layout	US (factory setting ¹⁾)
Japanese keyboard layout	JP

1) You can also recall the factory setting by pressing **CLEAR**.

- 5 Press **MENU/NO**.

Naming a track or MD using the keyboard

If you use a keyboard, you can quickly enter or edit names. While editing a name, you can move the cursor in jumps or scroll the name.

Shortcut to the naming procedure

- 1 Press [Enter] while the deck is in one of the operating modes listed below, depending on what you want to name:

To name	Press while the deck is
A track	Playing, paused, recording, or stopped with the track number displayed
The MD	Stopped with total number of tracks displayed

A flashing cursor appears in the display.

- 2 Enter a name.

In addition to letter keys, you can also use the keys shown in the following table.

- 3 Press [Enter].

The whole name appears in the display.

Operations you may want to do while naming a track or MD

To	Press on the keyboard
Cancel the operation	[Esc]
Switch between uppercase and lowercase letters	[Caps Lock]
Move the cursor	[←] or [→]
Scroll the name	[Page Up] or [Page Down]
Erase the character at the cursor position	[Delete]
Erase the character preceding the cursor	[Back Space]

Using the Edit Menu

- 1 Press [Esc] while the deck is in one of the operating modes listed below, depending on what you want to name:

To name	Press while the deck is
A track or the MD	Stopped, playing, or paused
The track being recorded	Recording the track

“Edit Menu” appears in the display.

- 2 Press [F10]/[F11] repeatedly until “Name ?” appears, then press [F12].

While the deck is recording, a flashing cursor appears in the display and you can enter a name for the track being recorded. In this case, go to step 5.

- 3 Press [F10]/[F11] repeatedly until “Nm In ?” appears, then press [F12].

- 4 Press [F10]/[F11] repeatedly until the track number (when naming a track) or “Disc” (when naming the MD) flashes, then press [F12].

A flashing cursor appears.

- 5 Enter a name.

- 6 Press [F12].

The whole name appears in the display.

Operating the deck using the keyboard

You can operate the MD deck by using the keyboard keys. This allows you to edit MDs and control the deck without using buttons and control on the deck and on the remote.

Operations using the keyboard

For details about each function, see “Front panel description” on page 4 or “Remote control description” on page 6.

As the keyboard substitutes for the following functions	Press
MENU/NO	[Esc]
▷	[F1]
	[F2]
■	[F3]
AMS or ◀◀	[F10]
AMS or ▶▶	[F11]
YES	[F12]
◀◀	[←]
▶▶	[→]
CLEAR	[Delete]

Operations using numeric keypads

While a track is selected, you can edit the track directly with the following numeric keypads.

To	Press
Divide the track	[/]
Move the track	[*]
Erase the track	[-]
Combine tracks	[+]

Note

If you press [/], [*], or [+] when no track is selected, “Cannot Edit” appears.

Assigning characters to keyboard keys

Assigning a character

If your keyboard layout does not match the system settings, the display may show the wrong characters or no characters at all when you press the keys. In this case, you need to assign characters to the keys.

- 1 While the deck is stopped, press [Esc] twice.**
“Setup Menu” appears in the display.
- 2 Press [F10]/[F11] repeatedly until “Keyboard ?” appears, then press [F12].**
- 3 Press [F10]/[F11] repeatedly until “Assign ?” appears, then press [F12].**
- 4 Press [F10]/[F11] repeatedly until the character you want to assign appears.**
If the character has already been assigned, “User” appears. If it has not been assigned, “Default” appears.
- 5 Press [F12].**
“<Set Key>” flashes in the display.
- 6 Press the key to be assigned to on the keyboard.**
“Key Change” appears, and the selected character is assigned to the key.

If “Same Key” appears

The same character is already assigned to the key.

If “Remove old assign?” appears

A different character is already assigned to the key. Press [F12] to clear the current assignment and assign the new character. Press [Esc] to cancel.

Notes

- You can assign a character using [Shift] only for symbol and number keys.
- You cannot assign a character to the following keys: [Esc], [F1] – [F12], [Back Space], [Tab], [Caps Lock], [Enter], [Shift], [Ctrl], [Alt], [Windows], [Space], [Application], [Print Screen], [Scroll Lock], [Pause], [Insert], [Delete], [Home], [End], [Page Up], [Page Down], [Num Lock], [←], [→], [↑], [↓], and [/], [*], [-], [+] (of the numeric keypads)
- “Key Change” does not appear in step 6 if you try to assign a character to one of the keys listed above or other keys for which input is not accepted.

Clearing key assignments

You can clear key assignments one at a time or all at once.

To clear a key assignment

- 1 Do steps 1 to 3 of “Assigning a character” on page 48.**

2 Press [F10]/[F11] repeatedly until the character you want to clear appears, then press [F12].

“<Set Key>” flashes in the display.

3 Press [Delete].

“Key Clear” appears and the key assignment is cleared.

To clear all key assignments

1 Do steps 1 to 3 of “Assigning a character” on page 48.

2 Press [Ctrl], [Alt], and [Delete] simultaneously.

“All Reset ?” appears in the display.

3 Press [F12].

“Complete!!” appears, and all assignments are cleared.

To cancel the operation

Press [Esc].

Additional Information

This chapter provides additional information that will help you understand and maintain your MD deck system.

Precautions

On safety

- Should any solid object or liquid fall into the cabinet, unplug the deck and have it checked by qualified personnel before operating it any further.
- Caution – The use of optical instruments with this product will increase eye hazard.

On power sources

- Before operating the deck, check that the operating voltage of the deck is identical with your local power supply. The operating voltage is indicated on the nameplate at the rear of the deck.
- The unit is not disconnected from the AC power source (mains) as long as it is connected to the wall outlet, even if the unit itself has been turned off.
- If you are not going to use the deck for a long time, be sure to disconnect the deck from the wall outlet. To disconnect the AC power cord, grasp the plug itself; never pull the cord.
- AC power cord must be changed only at the qualified service shop.

On condensation in the deck

If the deck is brought directly from a cold to a warm location, or is placed in a very damp room, moisture may condense on the lenses inside the deck. Should this occur, the deck may not operate properly. In this case, remove the MD and leave the deck turned on for several hours until the moisture evaporates.

On the MiniDisc cartridge

- Do not open the shutter to expose the MD.
- Do not place the cartridge where it will be subject to extremes of sunlight, temperature, moisture or dust.

On cleaning

Clean the cabinet, panel and controls with a soft cloth slightly moistened with a mild detergent solution. Do not use any type of abrasive pad, scouring powder or solvent such as alcohol or benzene.

If you have any questions or problems concerning your deck, please consult your nearest Sony dealer.

Handling MDs

The MD is enclosed in a cartridge to protect the disc from debris or fingerprints and to make it easy to handle. However, the presence of debris or a warped cartridge may inhibit the disc from operating properly. To ensure that you can always listen to the highest quality music, follow the precautions below:

- Do not touch the internal disc directly. Forcing the shutter open may damage the internal disc.
- Be sure to stick the labels supplied with the MD to the appropriate positions. The shape of the labels may vary depending on the MD brand.

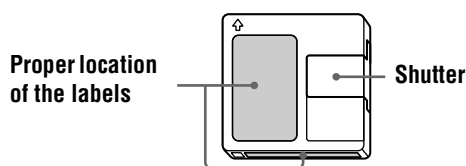

Where to keep the MDs

Do not place the cartridge where it may be exposed to direct sunlight or extremely high heat and humidity.

Regular maintenance

Wipe dust and debris from the surface of the cartridge with a dry cloth.

System limitations

The recording system in your deck is radically different from those used in cassette and DAT decks and is characterized by the limitations described below. Note, however, that these limitations are due to the inherent nature of the MD recording system itself and not to mechanical causes.

“Disc Full” appears in the display even before the MD has reached the maximum recording time

When 255 tracks have been recorded to the MD, “Disc Full” appears regardless of the total recorded time. More than 255 tracks cannot be recorded to the MD. To continue recording, erase unnecessary tracks or use another recordable MD.

“Disc Full” appears before the maximum number of tracks is reached

Fluctuations in emphasis within tracks are sometimes interpreted as track intervals, incrementing the track count and causing “Disc Full” to appear.

The remaining recording time does not increase even after erasing numerous short tracks

Tracks under 12 seconds* in length are not counted and so erasing them may not lead to an increase in the recording time.

- * *During stereo recording.*
In MONO or LP2 mode: about 24 seconds
In LP4 mode: about 48 seconds

The total recorded time and the remaining recordable time on the MD may not total the maximum recording time

Recording is done in minimum units of two seconds* each, no matter how short the material is. The contents recorded may thus be shorter than the maximum recording capacity. Disc space may also be further reduced by scratches.

- * *During stereo recording.*
In MONO or LP2 mode: about 4 seconds
In LP4 mode: about 8 seconds

Limitations when recording over an existing track

- The correct remaining recordable time may not be displayed.
- You may find it impossible to record over a track if that track has been recorded over several times already. If this happens, erase the track (see page 31).
- The remaining recordable time may be shortened out of proportion to the total recorded time.
- Recording over a track to eliminate noise is not recommended since this may shorten the duration of the track.
- You may find it impossible to name a track while recording over an existing track.

Tracks created through editing may exhibit sound dropout as you are searching for a point while monitoring the sound.

Some tracks cannot be combined with others

Tracks may not be combined if they have been edited.

Track numbers are not marked correctly

Incorrect assignment or marking of track numbers may result when CD tracks are divided into several smaller tracks during digital recording. Also, when the Automatic Track Marking is activated during recording, track numbers may not be marked as in the original, depending on the program source.

“TOC Reading” appears for a long time

If the inserted recordable MD is brand new, “TOC Reading” appears in the display longer than for MDs that have already been used.

The correct recorded/playing time may not be displayed during play of MDs recorded in monaural mode.

Guide to the Serial Copy Management System

Digital audio components, such as CDs, MDs, and DATs, make it easy to produce high-quality copies of music by processing music as a digital signal.

To protect copyrighted music sources, this deck uses the Serial Copy Management System, which allows you to make only a single copy of a digitally recorded source through digital-to-digital connections.

You can make only a first-generation copy¹⁾ through a digital-to-digital connection.

Examples are as follows:

- You can make a copy of a commercially available digital sound program (for example, a CD or MD), but you cannot make a second copy from the first-generation copy.
- You can make a copy of a digital signal from a digitally recorded analog sound program (for example, an analog record or a music cassette tape) or from a digital satellite broadcast program, but you cannot make a second copy from the first-generation copy.

1) *A first-generation copy means the first recording of a digital audio source through the deck's digital input connector. For example, if you record from a CD player connected to the DIGITAL IN connector, that copy is a first-generation copy.*

Note

The restrictions of the Serial Copy Management System do not apply when you make a recording through the analog-to-analog connections.

Troubleshooting

If you experience any of the following difficulties while using the deck, use this troubleshooting guide to help you remedy the problem. Should any problem persist, consult your nearest Sony dealer.

The deck does not operate or operates poorly.

- ➔ The MD may be dirty or damaged. Replace the MD.

The deck does not play.

- ➔ Moisture has formed inside the deck. Take the MD out and leave the deck in a warm place for several hours until the moisture evaporates.
- ➔ The deck is not on. Press I/⏻ to turn on the deck.
- ➔ The deck may not be connected to the amplifier correctly. Check the connection (page 11).

- ➔ The MD is inserted in the wrong direction. Slide the MD into the disc slot with the label side up and the arrow pointing toward the slot (page 4).
- ➔ The MD may not be recorded. Replace the disc with one that has been recorded.

The sound has a lot of static.

- ➔ Strong magnetism from a television or a similar device is interfering with operations. Move the deck away from the source of strong magnetism.

The deck does not record.

- ➔ The MD is record-protected. Slide the record-protect tab and close the slot (page 14).
- ➔ The deck is not connected properly to the program source. Check the connection (page 11).
- ➔ Select the correct program source using INPUT.
- ➔ The recording level is not adjusted properly. Adjust the recording level (page 16).
- ➔ A premastered MD is inserted. Replace it with a recordable MD.
- ➔ There is not enough time left on the MD. Replace it with another recordable MD with fewer recorded tracks, or erase unnecessary tracks (page 31).
- ➔ There has been a power failure or the AC power cord has been disconnected during recording. Data recorded to that point may be lost. Repeat the recording procedure.

The deck does not perform Synchro-recording with a CD player or video CD player.

- ➔ The remote supplied with the MD deck is not set correctly. Reset the remote.

A message and a three- or five-digit alphanumeric code alternate in the display.

- ➔ The Self-diagnosis function is on (page 53).

The keyboard does not operate (MDS-JE640 only).

- ➔ Disconnect the keyboard, then re-connect it.

Note

If the deck does not operate properly even after you have attempted the prescribed remedies, turn off the deck, then re-insert the plug into the power outlet.

Self-diagnosis function

The deck's self-diagnosis function automatically checks the condition of the MD deck when an error occurs, then issues a three- or five-digit code and an error message on the display. If the code and message alternate, find them in the following table and perform the indicated countermeasure. Should the problem persist, consult your nearest Sony dealer.

Three- or five-digit code/ Message	Cause/Remedy
C11/Protected	The inserted MD is record-protected. ➔ Take out the MD and close the record-protect slot (page 14).
C12/Cannot Copy	You tried to record a CD with a format that the external device connected to the deck does not support, such as CD-ROM or video CD. ➔ Remove the disc and insert a music CD.
C13/REC Error	The recording was not made properly. ➔ Set the deck in a stable surface, and repeat the recording procedure.
	The inserted MD is dirty (with smudges, fingerprints, etc.), scratched, or substandard in quality. ➔ Replace the disc and repeat the recording procedure.
C13/Read Error	The deck could not read the TOC on the MD properly. ➔ Take out the MD and insert it again.
C14/Toc Error	The deck could not read the TOC on the MD properly. ➔ Insert another disc. ➔ If possible, erase all the tracks on the MD (page 32).
C41/Cannot Copy	The sound source is a copy of commercially available music software, or you tried to record a CD-R (Recordable CD). ➔ The Serial Copy Management System prevents making a digital copy (page 52). You cannot record a CD-R.

Three- or five-digit code/ Message	Cause/Remedy
C71/Din Unlock	The sporadic appearance of this message is caused by the digital signal being recorded. This will not affect the recording.
	While recording from a digital component connected through the DIGITAL IN connector, the digital connecting cable was unplugged or the digital component turned off. ➔ Connect the cable or turn the digital component back on.
E0001/ MEMORY NG	There is an error in the internal data that the deck needs in order to operate. ➔ Consult your nearest Sony dealer.
E0101/ LASER NG	There is a problem with the optical pickup. ➔ The optical pickup may have failed. Consult your nearest Sony dealer.

Display messages

The following table explains the various messages that appear in the display. Messages are also displayed by the deck's Self-diagnosis function (see page 53).

Message	Meaning
Auto Cut	The Auto Cut Function is on (page 18).
Blank Disc	A new (blank) or erased MD has been inserted.
Cannot Copy	An attempt was made to make a second copy from a digitally dubbed MD (page 52).
Cannot Edit	An attempt was made to edit a premastered MD, to edit the MD during Program or Shuffle Play or to change the recording level of an MD recorded in LP2 or LP4 Stereo mode.
Disc Full	The MD is full (page 51).
Impossible	The deck cannot do the specified operation (pages 14, 32 and 34).
Incomplete!(!)	The S.F Edit (changing the recording level after recording, Fade-in, Fade-out) operation was not performed properly because the deck was moved while recording was in progress or the MD is damaged or dirty.
Initialize (flashing)	The Setup Menu settings have been lost. Or the contents recorded by the timer have disappeared over time and are not be available for saving to disc, or Program Play could not be activated since the program has disappeared over time. (The message flashes for about four seconds when you turn on the deck by pressing I/⏻.)
Name Full!(!)	The naming capacity of the MD has reached its limit (about 1,700 characters).
No Change	While attempting to change the recording level after recording, you pressed MENU/NO without actually changing the recording level, so no change was made.
No Disc	There is no MD in the deck.
No Name	The track or disc has no name.
No Program!(!)	You tried to start Program Play when no program exists.
Premastered	An attempt was made to record to a premastered MD.
ProgramFull(!)	The program contains the maximum number of tracks. You cannot add any more tracks.

Message	Meaning
REMOTE	The MD is being controlled by an external device connected to the deck. ¹⁾
S.F Edit!	You attempted to perform another operation while in S.F Edit (changing the recording level after recording, Fade-in, Fade-out) mode. You cannot perform any other operations while in S.F Edit mode.
(S.F) Edit NOW	You pressed I/⏻ while in S.F Edit (changing the recording level after recording, Fade-in, Fade-out) mode. If you turn off the deck while in S.F Edit mode, any changes that you have made will not be made properly. Finish the changes and leave S.F Edit mode before turning off the deck. If you accidentally turn off the deck while changes are being made, press I/⏻ while the message is displayed.
Smart Space	The Smart Space Function is on (page 18).
TOC Reading	The deck is checking the TOC (Table Of Contents) on the MD.

1) If "REMOTE" appears under other circumstances, turn off the deck, then turn it on again.

Specifications

System	MiniDisc digital audio system
Disc	MiniDisc
Laser	Semiconductor laser ($\lambda = 780 \text{ nm}$) Emission duration: continuous
Laser output	MAX 44.6 μW^1 <i>1) This output is the value measured at a distance of 200 mm from the objective lens surface on the Optical Pick-up Block with 7 mm aperture.</i>
Laser diode	Material: GaAlAs
Revolutions (CLV)	400 rpm to 900 rpm
Error correction	ACIRC (Advanced Cross Interleave Reed Solomon Code)
Sampling frequency	44.1 kHz
Coding	ATRAC (Adaptive TRansform Acoustic Coding)/ATRAC 3
Modulation system	EFM (Eight-to-Fourteen Modulation)
Number of channels	2 stereo channels
Frequency response	5 to 20,000 Hz $\pm 0.3 \text{ dB}$
Signal-to-noise ratio	MDS-JE440: Over 96 dB during play MDS-JE640: Over 98 dB during play
Wow and flutter	Below measurable limit
Inputs	
ANALOG IN	Jack type: phono Impedance: 47 kilohms Rated input: 500 mVrms Minimum input: 125 mVrms
DIGITAL IN	Connector type: square optical Impedance: 660 nm (optical wave length)
DIGITAL OPTICAL IN (MDS-JE640 European models only)	Connector type: square optical Impedance: 660 nm (optical wave length)
DIGITAL COAXIAL IN (MDS-JE640 European models only)	Jack type: phono Impedance: 75 ohms Rated input: 0.5 Vp-p, $\pm 20 \%$

Outputs

PHONES (MDS-JE640 only)	Jack type: stereo phone Rated output: 28 mW Load impedance: 32 ohms
ANALOG OUT	Jack type: phono Rated output: 2 Vrms (at 50 kilohms) Load impedance: over 10 kilohms
DIGITAL OUT	Connector type: square optical Rated output: -18 dBm Load impedance: 660 nm (optical wave length)
DIGITAL OPTICAL OUT (MDS-JE640 European models only)	Connector type: square optical Rated output: -18 dBm Load impedance: 660 nm (optical wave length)

General

Power requirements

Where purchased	Power requirements
U.S.A. and Canada	120 V AC, 60 Hz
Europe	220 – 230 V AC, 50/60 Hz
Australia	240 V AC, 50/60 Hz
Hong Kong	220 – 240 V AC, 50/60 Hz
Other countries	110 – 120 or 220 – 240 V AC selectable, 50/60 Hz

Power consumption	15 W
Dimensions (approx.)	430 × 95 × 285 mm (17 × 3 3/4 × 11 1/4 in.) (w/h/d) incl. projecting parts and controls
Mass (approx.)	MDS-JE440: 3.0 kg (6 lbs 10 oz) MDS-JE640: 3.1 kg (6 lbs 14 oz)

Supplied accessories

See page 10.

US and foreign patents licensed from Dolby Laboratories.

Design and specifications are subject to change without notice.

Edit menu table

The following table provides a quick guide to the various editing functions that you can perform using the Edit Menu.

To access the Edit Menu

Press MENU/NO to display “Edit Menu.”

Note

The available menu items may vary according to the current status of the deck.

Menu item	Sub-item	Function	Reference page
Name ?	Nm In ?	Names a track or an MD.	35
	Nm Copy ?	Copies a name to a track or an MD.	36
	Nm Erase ?	Erases a name.	37
	Nm All Ers?	Erases all the names on an MD.	37
Tr Erase ?	—	Erases a track.	31
Move ?	—	Moves a track.	34
Combine ?	—	Combines tracks.	34
Divide ?	—	Divides a track.	33
A-B Erase ?	—	Erases a portion of a track.	32
All Erase ?	—	Erases all the tracks on an MD.	32
Undo ?	—	Undoes the last edit operation.	39
S.F Edit?	Tr Level ?	Changes the overall recorded level after recording.	37
	Fade In ?	Records over a track using Fade-in Recording.	38
	Fade Out ?	Records over a track using Fade-out Recording.	38
Setup ?	—	Enters Setup Menu (below) directly.	—

Setup menu table

The following table provides an overview of the various Setup Menu items, including their parameters, factory settings, and reference page(s) in the manual.

To access the Setup Menu

While the deck is stopped, press MENU/NO twice to display “Setup Menu.”

Menu item	Sub-item	Function	Parameters	Factory setting	Reference page
Program ?	—	Creates a program.	—	—	27
T.Mark	—	Turns Automatic Track Marking on or off.	Lsyn/Off	Lsyn	19
LS(T)	—	Changes the trigger level for Automatic Track Marking.	-72 to 0dB ²⁾	-50dB	19
Auto ¹⁾	—	Turns Auto Space and Auto Pause on or off.	Off/Space/Pause	Off	29
S.Space	—	Turns Smart Space and Auto Cut on or off.	On/Off	On	18
P.Hold	—	Turns Peak Hold on or off.	On/Off	Off	17
F.in	—	Sets the duration of Fade-in Play and Recording.	1.0 to 15.0s	5.0s	41
F.out	—	Sets the duration of Fade-out Play and Recording.	1.0 to 15.0s	5.0s	41
Pitch ¹⁾	—	Changes the playing speed by auto steps.	-36 to 0	0	40
Pfine ¹⁾	—	Fine controls the playing speed.	-87.5 to 0.0%	0.0%	40
Ain ¹⁾	—	Adjusts the analog signal level input through the ANALOG IN jacks.	-∞ to +12.0dB	0.0dB	17
Opt1 or Coax ¹⁾	—	Adjusts the digital signal level input through the DIGITAL OPTICAL IN1 connector or DIGITAL COAXIAL IN jack.	-∞ to +18.0dB	0.0dB	17

Menu item	Sub-item	Function	Parameters	Factory setting	Reference page
Opt2 or Opt ¹⁾	—	Adjusts the digital signal level input through the DIGITAL OPTICAL IN(2) connector.	$-\infty$ to +18.0dB	0.0dB	17
Aout ¹⁾	—	Adjusts the analog signal level output to the ANALOG OUT and PHONES jacks.	-20.2 to 0.0dB	0.0dB	24
Sleep ¹⁾	—	Sets the duration of Sleep Timer.	30/60/90/ 120min	60min	42
Sleep	—	Turns Sleep Timer on or off.	On/Off	Off	42
Keyboard ? ¹⁾	Type	Selects the type of the keyboard connected to the deck.	US/JP	US	46
	Assign ?	Assigns a character to the keyboard connected to the deck.	—	—	48
LPstamp	—	Sets whether to automatically add “LP:” at the beginning of a track name during a long time recording.	On/Off	On	15

1) MDS-JE640 only

2) Adjustable in 2 dB steps.

To recall a factory setting

Press CLEAR while selecting the parameter.

Index

A

- AMS 24
- Audio connecting cord 12
- Auto cut 18
- Auto pause 29
- Auto space 29
- Auto step control 40
- Automatic track marking 19

B

- Battery 10
- Blank
 - erasing during recording. *See* Smart space and Auto cut
 - inserting during play. *See* Auto space

C

- CD Synchro-recording 21
- Combining 34
- CONTROL AIII control system 44

D

- Disc memo copy 21
- Disc name 35
- Display
 - disc name 24
 - messages 54
 - remaining recordable time 17
 - total number of tracks 9, 17
 - total recorded time 9, 17
 - track name 24
 - window 8
- Dividing 33

E

- Erasing
 - a name 37
 - a portion of a track 32
 - a track 31
 - a track number 34
 - all names 37
 - all tracks 32

F

- Fade-in 41
- Fade-out 41
- Fine control 40

H

- Headphones 23
- Hooking up 11

I

- Input monitor 17

K

- Keyboard
 - assigning characters 48
 - naming a track or MD 47
 - operating the deck 48
 - setting 46

L

- Level
 - input signal 9, 14
 - output signal 24
 - recording 16

Locating

- particular point 25
- tracks 24
- LP mode 15

M

- Manual track marking 19
- MD (MiniDisc)
 - ejecting 14, 23
 - record-protect tab 14

Menu

- edit 56
- setup 56

Monitoring input signal. *See* Input monitor

Moving 34

Music Synchro-recording 20

N

Naming

- copying 36
- how to 35
- renaming 36
- using the keyboard 47

O

Optical cable 12

P

Pausing

- after each track. *See* Auto pause
- play 23
- recording 14

Peak hold 17

Peak level meters 17

Pitch control 40

Playing

- entering the number 24
- from the first track 23
- specific track. *See* Locating

Program play

- changing the contents 28
- checking the contents 28
- programming 27

R

Recording

- how to 13
- level 16
- mode 15
- over existing tracks 13

Remote control 6

Repeat A-B play 26

Repeat All play 26

Repeat 1 play 26

Repeating

- a portion. *See* Repeat A-B play
- all tracks. *See* Repeat All play
- current track. *See* Repeat 1 play

S

- Sampling rate converter 15
- SCMS. *See* Serial Copy Management System
- Scrolling the name 24
- Self-diagnosis function 53
- Serial Copy Management System 52
- Shuffle play 27
- Sleep timer 42
- Smart space 18
- Supplied accessories 10
- System limitations 51
- S.F Edit 37

T

- Time machine recording 20
- Timer
 - falling asleep to music 42
 - playing 43
 - recording 43
- TOC 15, 31
- Track marking 19
- Troubleshooting 52

U

- Undoing 39

