

SONY®

3-082-311-11(1)

Digital Still Camera

Operating Instructions

Before operating the unit, please read this manual thoroughly, and retain it for future reference.

Owner's Record

The model and serial numbers are located on the bottom. Record the serial number in the space provided below. Refer to these numbers whenever you call upon your Sony dealer regarding this product.

Model No. DSC-V1

Serial No. _____

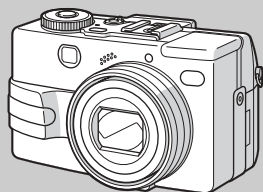

Cyber-shot

Digital Still Camera



MEMORY STICK™



DSC-V1

© 2003 Sony Corporation

Getting started _____

Shooting still images _____

Viewing still images _____

Deleting still images _____

Before advanced operations _____

Advanced still image shooting _____

Advanced still image viewing _____

Still image editing _____

Enjoying movies _____

Enjoying images on your computer _____

Troubleshooting _____

Additional information _____

Index _____

WARNING

To prevent fire or shock hazard, do not expose the unit to rain or moisture.

CAUTION

The use of optical instruments with this product will increase eye hazard. Use of controls or adjustments or performance of procedures other than those specified herein may result in hazardous radiation exposure.

For the Customers in the U.S.A.

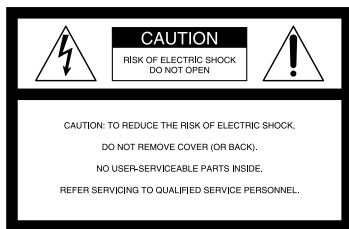

This symbol is intended to alert the user to the presence of uninsulated "dangerous voltage" within the product's enclosure that may be of sufficient magnitude to constitute a risk of electric shock to persons.



This symbol is intended to alert the user to the presence of important operating and maintenance (servicing) instructions in the literature accompanying the appliance.

If you have any questions about this product, you may call:

Sony Customer Information Center
1-800-222-SONY (7669)

The number below is for the FCC related matters only.

Regulatory Information

Declaration of Conformity

Trade Name: SONY
Model No.: DSC-V1
Responsible Party: Sony Electronics Inc.
Address: 680 Kinderkamack Road,
Oradell, NJ 07649 U.S.A.
Telephone No.: 201-930-6972

This device complies with Part 15 of the FCC Rules. Operation is subject to the following two conditions: (1) This device may not cause harmful interference, and (2) this device must accept any interference received, including interference that may cause undesired operation.

CAUTION

You are cautioned that any changes or modifications not expressly approved in this manual could void your authority to operate this equipment.

Note:

This equipment has been tested and found to comply with the limits for a Class B digital device, pursuant to Part 15 of the FCC Rules. These limits are designed to provide reasonable protection against harmful interference in a residential installation. This equipment generates, uses, and can radiate radio frequency energy and, if not installed and used in accordance with the instructions, may cause harmful interference to radio communications. However, there is no guarantee that interference will not occur in a particular installation. If this equipment does cause harmful interference to radio or television reception, which can be determined by turning the equipment off and on, the user is encouraged to try to correct the interference by one or more of the following measures:

- Reorient or relocate the receiving antenna.
- Increase the separation between the equipment and receiver.
- Connect the equipment into an outlet on a circuit different from that to which the receiver is connected.
- Consult the dealer or an experienced radio/TV technician for help.

The supplied interface cable must be used with the equipment in order to comply with the limits for a digital device pursuant to Subpart B of Part 15 of FCC Rules.

For the Customers in the U.S.A. and Canada

RECYCLING LITHIUM-ION BATTERIES

Lithium-Ion batteries are recyclable.

You can help preserve our environment by returning your used rechargeable batteries to the collection and recycling location nearest you.



For more information regarding recycling of rechargeable batteries, call toll free 1-800-822-8837, or visit <http://www.rbc.org/>



Caution: Do not handle damaged or leaking Lithium-Ion batteries.

CAUTION

TO PREVENT ELECTRIC SHOCK, MATCH WIDE BLADE OF PLUG TO WIDE SLOT, FULLY INSERT.

Notice for the customers in the United Kingdom

A moulded plug complying with BS 1363 is fitted to this equipment for your safety and convenience.

Should the fuse in the plug supplied need to be replaced, a fuse of the same rating as the supplied one and approved by ASTA or BSI to BS 1362, (i.e., marked with  or  mark) must be used.

If the plug supplied with this equipment has a detachable fuse cover, be sure to attach the fuse cover after you change the fuse. Never use the plug without the fuse cover. If you should lose the fuse cover, please contact your nearest Sony service station.

Attention for the Customers in Europe

This product has been tested and found compliant with the limits sets out in the EMC Directive for using connection cables shorter than 3 meters (9.8 feet).

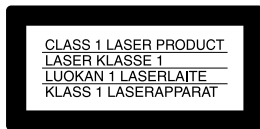

Attention

The electromagnetic field at the specific frequencies may influence the picture and sound of this camera.

Notice

If static electricity or electromagnetism causes data transfer to discontinue midway (fail), restart the application or disconnect and connect the USB cable again.

“Memory Stick” and battery pack



For the Customers in the U.S.A.

THIS DEVICE COMPLIES WITH PART 15 OF THE FCC RULES. OPERATION IS SUBJECT TO THE FOLLOWING TWO CONDITIONS:

(1) THIS DEVICE MAY NOT CAUSE HARMFUL INTERFERENCE, AND
(2) THIS DEVICE MUST ACCEPT ANY INTERFERENCE RECEIVED, INCLUDING INTERFERENCE THAT MAY CAUSE UNDESIRE OPERATION.

For the Customers in Canada

THIS CLASS B DIGITAL APPARATUS COMPLIES WITH CANADIAN ICES-003.

Notice

Certain countries may regulate disposal of the battery used to power this product. Please consult with your local authority.

Before using your camera

Trial recording

Before you record one-time events, you may want to make a trial recording to make sure that the camera is working correctly.

No compensation for contents of the recording

Contents of the recording cannot be compensated for if recording or playback is not possible due to a malfunction of your camera or recording media, etc.

Back up recommendation

To avoid the potential risk of data loss, always copy (back up) data to a disk.

Notes on image data compatibility

- This camera conforms with the Design rule for Camera File system universal standard established by the JEITA (Japan Electronics and Information Technology Industries Association).
- Playback of images recorded with your camera on other equipment and playback of images recorded or edited with other equipment on your camera are not guaranteed.

Precaution on copyright

Television programs, films, video tapes, and other materials may be copyrighted. Unauthorized recording of such materials may be contrary to the provision of the copyright laws.

Do not shake or strike the camera

In addition to malfunctions and inability to record images, this may render the “Memory Stick” unusable or image data breakdown, damage or loss may occur.

LCD screen, LCD finder (only models with an LCD finder) and lens

- The LCD screen and the LCD finder are manufactured using extremely high-precision technology so over 99.99% of the pixels are operational for effective use. However, there may be some tiny black points and/or bright points (white, red, blue or green in color) that constantly appear on the LCD screen and the LCD finder. These points are normal in the manufacturing process and do not affect the recording in any way.
- Be careful when placing the camera near a window or outdoors. Exposing the LCD screen, the finder or the lens to direct sunlight for long periods may cause malfunctions.
- Images may be trailed on the LCD screen in a cold location. This is not a malfunction.

The power zoom lens

This camera is equipped with a power zoom lens. Be careful not to bump the lens, and be careful not to apply force to it.

Clean the flash surface before use

The heat of flash emission may cause dirt on the flash surface to become discolored or to stick to the flash surface, resulting in insufficient light emission.

Do not get the camera wet

When taking pictures outdoors in the rain or under similar conditions, be careful not to get the camera wet. If moisture condensation occurs, see page 118 and follow the instructions on how to remove it before using the camera.

Do not expose the camera to sand or dust

Using the camera in sandy or dusty locations may cause malfunction.

Do not aim the camera at the sun or other bright light

This may cause irrecoverable damage to your eyes. Or it may cause the malfunction of your camera.

Notes on the camera locations

- Do not use the camera near a location that generates strong radio wave or emits radiation. The camera may not be able to record or playback properly.
- Do not use the camera near a TV, radio, tuner. Noise may be caused on the camera.

The pictures used in this manual

The photographs used as examples of pictures in this manual are reproduced images, and are not actual images shot using this camera.

Trademarks

- “Memory Stick,”  and “MagicGate Memory Stick” are trademarks of Sony Corporation.
- “Memory Stick Duo” and **MEMORY STICK DUO** are trademarks of Sony Corporation.
- “Memory Stick PRO” and **MEMORY STICK PRO** are trademarks of Sony Corporation.
- “MagicGate” and **MAGIC GATE** are trademarks of Sony Corporation.
- “InfoLITHIUM” is a trademark of Sony Corporation.
- Microsoft and Windows are registered trademarks of the U.S. Microsoft Corporation in the United States and other countries.
- Macintosh, Mac OS, QuickTime, iBook and Power Mac are trademarks or registered trademarks of Apple Computer, Inc.
- Pentium is a trademark or a registered trademark of Intel Corporation.

- In addition, system and product names used in this manual are, in general, trademarks or registered trademarks of their respective developers or manufacturers. However, the TM or ® marks are not used in all cases in this manual.

About the Carl Zeiss lens

This camera is equipped with a Carl Zeiss lens which is capable of reproducing fine images. The lens for this camera uses the MTF* measurement system for cameras developed jointly by Carl Zeiss, in Germany, and Sony Corporation, and offers the same quality as other Carl Zeiss lenses.

* MTF is an abbreviation of Modulation Transfer Function, a numeric value indicating the amount of light from a specific part of the subject gathered at the corresponding position in the image.

Table of contents

Before using your camera	4
Identifying the parts	8

Getting started

Charging the battery pack	10
Using an external power source	13
Using your camera abroad	13
Turning on/off your camera	14
How to use the control button	14
Setting the date and time	15

Shooting still images

Inserting and removing a “Memory Stick”	17
Setting the still image size	18
Image size and quality	19
Basic still image shooting (using auto adjustment mode)	20
Checking the last image you shot — Quick Review	22
Using the zoom feature	23
Shooting close-ups — Macro	24
Using the self-timer	25
Selecting a flash mode	26
Shooting images with the finder	28
Inserting the date and time on a still image	29

Viewing still images

Viewing images on the LCD screen of your camera	30
Viewing images on a TV screen	32

Deleting still images

Deleting images	34
Formatting a “Memory Stick”	37

Before advanced operations

How to setup and operate your camera ..	39
Changing the menu settings	39
Changing the items in the SET UP screen	39
How to use the jog dial	40
Deciding the still image quality	41
Creating or selecting a folder	41
Creating a new folder	42
Changing the recording folder	42

Advanced still image shooting

Shooting with Program Shift — Program Shift	43
Shooting with the manual adjustments ..	43
Shutter speed priority mode	44
Aperture priority mode	45
Manual exposure mode	45
Choosing an auto focus method	45

Choosing a focus range finder frame — AF range finder	46
Choosing a focus operation — AF Mode	47
Setting the distance to the subject — Focus preset	48
Adjusting the exposure — EV adjustment	49
Displaying a histogram	50
Selecting the metering mode	51
Shooting with the exposure fixed — AE LOCK	52
Shooting three images with the exposure shifted — Exposure Bracket	53
Adjusting color tones — White Balance	55
Shooting in the dark	56
NightShot	56
NightFraming	57
Adjusting the flash level — Flash Level	58
Shooting multiple frames — Clip Motion	58
Shooting in Multi Burst mode — Multi Burst	60
Shooting three images continuously — Burst 3	60
Shooting still images in TIFF mode — TIFF	61

Shooting still images for e-mail	
— E-Mail.....	62
Shooting still images with audio files	
— Voice.....	62
Shooting according to scene conditions	
— Scene Selection.....	63
Adding special effects	
— Picture Effect.....	65
Using an external flash.....	65
Using the Sony flash (not supplied)....	66
Using a commercially available external flash	66
Using a conversion lens	67

Advanced still image viewing

Selecting the folder and playing back images	
— Folder.....	68
Enlarging a portion of a still image.....	69
Enlarging an image	
— Playback zoom.....	69
Recording an enlarged image	
— Trimming.....	70
Playing back successive images	
— Slide Show.....	70
Rotating still images	
— Rotate.....	71
Playing back images shot in Multi Burst mode	72

Playing back continuously.....	72
Playing back frame by frame	
— Jog playback.....	73

Still image editing

Protecting images	
— Protect	74
Changing image size	
— Resize	76
Choosing images to print	
— Print (DPOF) mark.....	76

Enjoying movies

Shooting movies	79
Viewing movies on the LCD screen.....	80
Deleting movies	
— Delete	81
Editing movies.....	83
Cutting movies.....	83
Deleting unnecessary portions of movies	84

Enjoying images on your computer

Copying images to your computer	
— For Windows users.....	85
Copying images to your computer	
— For Macintosh users	95

Troubleshooting

Troubleshooting	97
Warnings and messages	106
Self-diagnosis display	108

Additional information

Number of images that can be saved or shooting time.....	109
Menu items.....	111
SET UP items	115
Precautions	118
On “Memory Stick”	119
On “InfoLITHIUM” battery pack	120
Specifications	122
The LCD screen	124

Index

Index.....	128
------------	-----

Identifying the parts

See the pages in parentheses for details of operation.

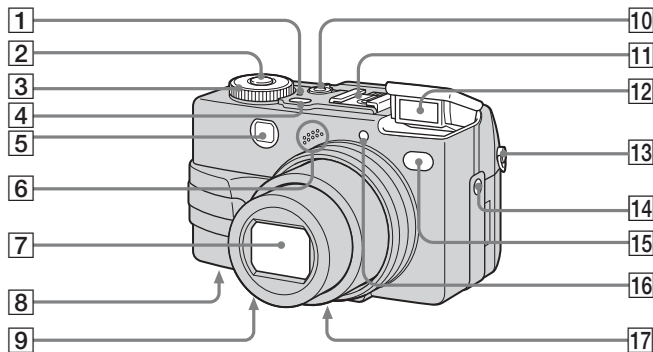

1 POWER lamp (14)

2 Shutter button (21)

3 Mode dial (15, 111)

📷: To shoot still images in auto adjustment mode

P: To shoot still images in programmed mode

S: To shoot in the shutter speed priority mode

A: To shoot in the aperture priority mode

M: To shoot in the manual exposure mode

SCN: To shoot in the Scene Selection mode

SET UP: To set the SET UP items

🎬: To shoot movies, Clip Motion images or Multi Burst mode images

▶: To view or edit images

4 POWER button (14)

5 Finder window

6 Microphone

7 Lens

8 RESET button (bottom surface) (97)

9 Speaker (bottom surface)

10 NIGHTSHOT/NIGHTFRAMING lever (56)

11 Advanced accessory shoe (65)

12 Flash (26)

13 Hook for shoulder* strap

14 ACC (Accessory) jack (65)

15 Self-timer lamp (25)/
Infrared ray emitter (56)









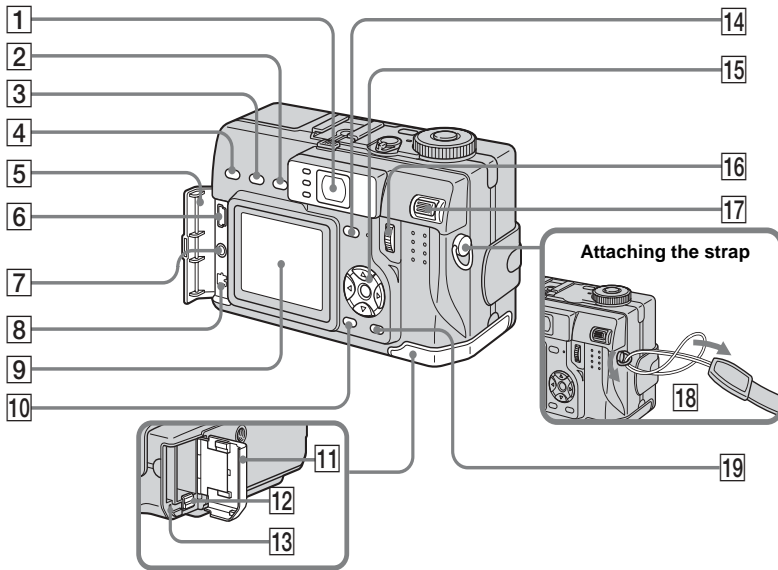

16 Hologram AF (27, 115)

17 Tripod screw hole (bottom surface)

* Shoulder strap is optional.

- The flash automatically pops up and strobes. Close the flash by hand after use.
- Use a tripod with a screw length of less than 5.5 mm (7/32 inch). You will be unable to firmly secure the camera to tripods having longer screws, and may damage the camera.
- Use ACC jack to connect an external flash or the remote control tripod.
- Do not touch the microphone while recording.



- 12** Battery eject lever (10)
- 13** Access lamp (17)
- 14**  (Display/LCD on/off) button (28)
- 15** Control button (Menu on)  /  /  /  / (Menu off)  /  /  /  (26, 25, 22, 24)
- 16** Jog dial (40)
- 17** Zoom lever (23)
- 18** Hook for hand strap
- 19**  /  (Image Size/Delete) button (18, 34)

1 Finder (28)

**Self-timer (25)/
recording lamp (red)**
(21)

**AE/AF lock lamp
(green)** (21, 28)

⚡/CHG lamp (orange)
(11, 26)

2 AE LOCK button (52)

3 FOCUS button (48)

4  (Exposure/Index) button
(49, 31)

5 Jack cover

6  (USB) jack (89)

7 A/V OUT (MONO) jack (32)

8 DC IN jack (10, 13)

9 LCD screen

10 MENU button (39, 111)

11 Battery/"Memory Stick" cover

Charging the battery pack

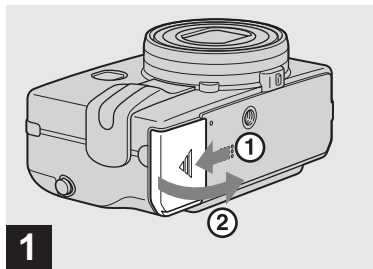

- 1** → Open the battery/“Memory Stick” cover.

Slide the cover in the direction of the arrow.

- Be sure to turn off your camera when charging the battery pack (page 14).
- Your camera operates with the “InfoLITHIUM” NP-FC11 battery pack (C type) (supplied). You can use only C type battery pack (page 120).

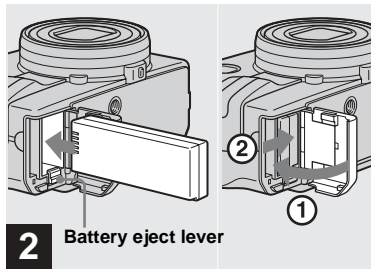

- 2** → Install the battery pack, then close the battery/“Memory Stick” cover.

Insert the battery pack with the ◀ mark facing toward the battery compartment as illustrated.

Make sure the battery pack is firmly inserted all the way, then close the cover.

- The battery pack is easily inserted by pushing the battery eject lever at the front of the battery compartment down.

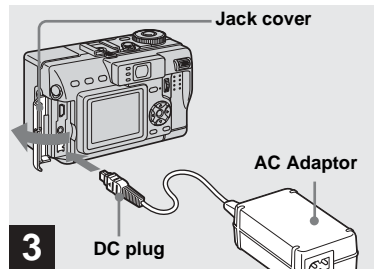

- 3** → Open the jack cover and connect the AC Adaptor (supplied) to the DC IN jack of your camera.

Open the cover in the arrow direction as illustrated above. Connect the plug with the ▲ mark facing left.

- Do not short the DC plug of the AC Adaptor with a metallic object, as this may cause malfunction.
- Clean the DC plug of the AC Adaptor with a dry cotton bud. Do not use the dirty plug. Use of the dirty plug may not properly charge the battery pack.

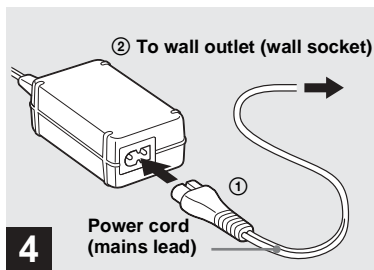

- 4** → Connect the power cord (mains lead) to the AC Adaptor and then to a wall outlet (wall socket).

The ζ /CHG lamp (orange) lights up when charging begins, and goes off when charging is completed.



- After charging the battery pack, disconnect the AC Adaptor from the DC IN jack of your camera.

To remove the battery pack

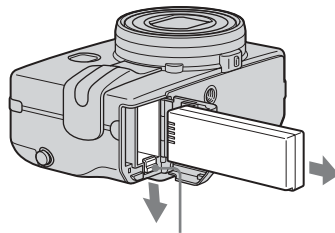

Battery eject lever

Open the battery/"Memory Stick" cover. Slide the battery eject lever in the direction of the arrow, and remove the battery pack.

- Be careful not to drop the battery pack when removing it.

Battery remaining indicator

The battery remaining indicator on the LCD screen shows the remaining shooting or viewing time.

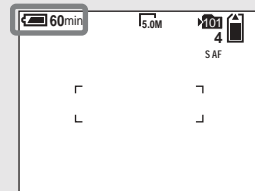

- The black portion of the battery remaining indicator in the illustration shows the actual remaining time.
- When you switch the LCD screen on/off, it takes about one minute for the correct battery remaining time to appear.
- The displayed time remaining may not be correct under certain circumstances or conditions.

Charging time

Approximate time to charge a completely discharged battery pack using the AC Adaptor at a temperature of 25°C (77°F).

Battery pack	Charging time (min.)
NP-FC11 (supplied)	Approx. 150

Number of images and battery life that can be recorded/ viewed

The tables show the approximate number of images and the battery life that can be recorded/ viewed when you shoot images in normal mode with a fully charged battery pack at a temperature of 25°C (77°F). The numbers of images that can be recorded or viewed take into account changing the supplied “Memory Stick” as necessary. Note that the actual numbers may be less than indicated depending on the conditions of use.

Shooting still images

Under the average conditions¹⁾

Image size	NP-FC11 (supplied)		
	LCD screen	No. of images	Battery life (min.)
5.0M	On	Approx. 150	Approx. 75
	Off	Approx. 200	Approx. 100
VGA	On	Approx. 150	Approx. 75
	Off	Approx. 200	Approx. 100

¹⁾ Shooting in the following situations:

- [P. Quality] is set to [Fine]
- Shooting one time every 30 seconds
- The zoom is switched alternately between the W and T ends
- The flash strobes once every two times
- The power turns on and off once every ten times
- [AF Mode] is set to [Single] in the SET UP settings

Viewing still images²⁾

Image size	NP-FC11 (supplied)	
	No. of images	Battery life (min.)
5.0M	Approx. 3500	Approx. 175
VGA	Approx. 3500	Approx. 175

²⁾ Viewing single images in order at about three second intervals

Shooting movies³⁾

NP-FC11 (supplied)	
LCD screen on	LCD screen off
Approx. 85	Approx. 130

³⁾ Shooting continuously at 160 (Mail) image size

- The number of images and the battery life that can be recorded/ viewed are decreased under the following conditions:
 - The surrounding temperature is low
 - The flash is used
 - The camera has been turned on and off many times
 - The zoom is used frequently
 - [LCD Backlight] is set to [Bright] in the SET UP settings
 - [Power Save] is set to [Off] in the SET UP settings
 - The battery power is low.
 - The battery capacity decreases as you use it more and more and as time passes (page 121).
 - [AF Mode] is set to [Monitor] or [Cont] in the SET UP settings

The Power Save function

When the Power Save function is activated, you can shoot for a longer period of time. Set the mode dial to SET UP, and set [Power Save] in  (Setup 1) to [On]. The factory setting is [Off] (page 117).

- [Power Save] appears only when you use the camera with the battery back.

When [Power Save] is set to [On]

While charging the flash, the $\frac{4}{5}$ /CHG lamp flashes and the LCD screen turns off. After the charging is complete, the lamp goes out and the LCD screen turns on.

Using an external power source

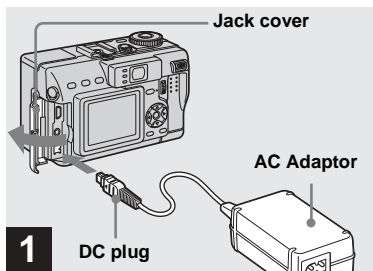

- 1** → Open the jack cover and connect the AC Adaptor (supplied) to the DC IN jack of your camera.

Open the cover in the arrow direction as illustrated above. Connect the plug with the ▲ mark facing left.

- Connect the AC Adaptor to an easily accessible wall outlet (wall socket) close by. If any trouble occurs while using the adaptor, immediately shut off the power by disconnecting the plug from the wall outlet (wall socket).

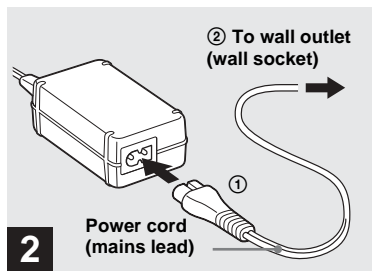

- 2** → Connect the power cord (mains lead) to the AC Adaptor and then to a wall outlet (wall socket).

- When you have finished using the AC Adaptor, disconnect it from the DC IN jack of the camera.
- The set is not disconnected from the AC power source (mains) as long as it is connected to the wall outlet (wall socket) even if the set itself has been turned off.

Using your camera abroad

Power sources

You can use your camera in any country or region with the supplied AC Adaptor within 100 V to 240 V AC, 50/60 Hz. Use a commercially available AC plug adaptor [a], if necessary, depending on the design of the wall outlet (wall socket) [b].

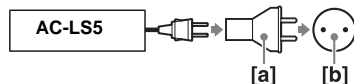

- Do not use an electronic transformer (travel converter), as this may cause a malfunction.

Turning on/off your camera

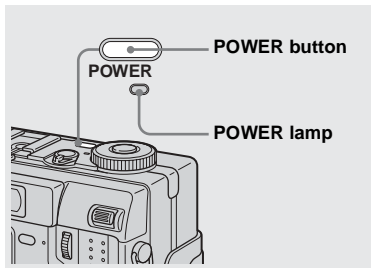

➔ Press POWER.

The POWER lamp (green) lights up and the power is on. When you turn on your camera for the first time, the Clock Set screen appears (page 15).

Turning off the power

Press POWER again. The POWER lamp goes out, and the camera turns off.

- Do not leave the camera with the lens portion extended for a long period of time with the battery pack or the AC Adaptor removed, as this may cause a malfunction.
- If you turn on the power when the mode dial is set to , P, S, A, M, SCN or , the lens portion moves. Do not touch the lens portion while it is operating.

Auto power-off function

If you do not operate the camera for a while* during shooting or viewing or when performing SET UP, the camera turns off automatically to prevent wearing down the battery. The auto power-off function only operates when the camera is operating using a battery pack. The auto power-off function also will not operate in the following circumstances.

- When viewing movies
- When playing back a slide show
- When a connector is plugged into the (USB) jack or the A/V OUT (MONO) jack.

* When [Power Save] is set to [On]:
approximately 90 seconds
When [Power Save] is set to [Off]:
approximately three minutes

How to use the control button

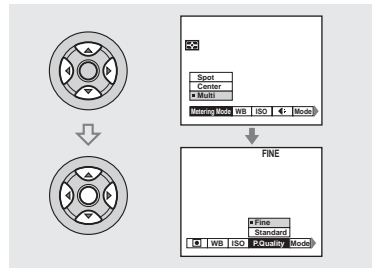



To change the current settings of the camera, bring up the menu or the SET UP screen (page 39), and use the control button to make the changes.

For each item, press / / / to select the desired value, then press the center or / / / to make the setting.

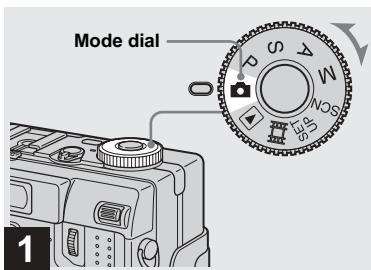
Setting the date and time



➔ Set the mode dial to .

- You can also carry out this operation when the mode dial is set to P, S, A, M, SCN,  or .
- To change the date and time, set the mode dial to SET UP, select [Clock Set] in  (Setup 1) (pages 39 and 117), and perform the procedure from step **3**.

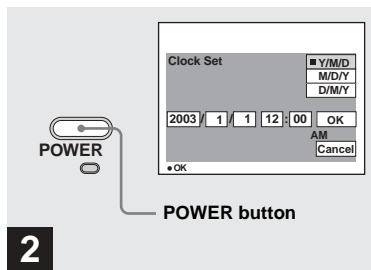

➔ Press **POWER** to turn on the power.

The POWER lamp (green) lights up and the Clock Set screen appears on the LCD screen.

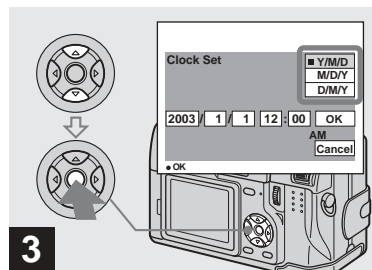

➔ Select the desired date display format with **▲/▼** on the control button, then press **●**.

Select from [Y/M/D] (year/month/day), [M/D/Y] (month/day/year) or [D/M/Y] (day/month/year).

- If the rechargeable button battery, which provides the power for saving the time data, is ever fully discharged (page 119), the Clock Set screen will appear again. When this happens, reset the date and time, by starting from step **3** above.

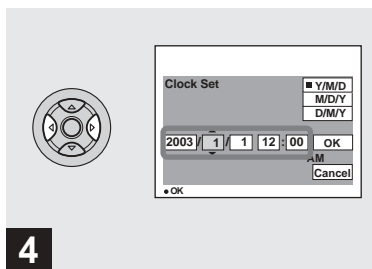

4 → Select the year, month, day, hour or minute item you want to set with ◀/▶ on the control button.

The item to be set is indicated with ▲/▼.

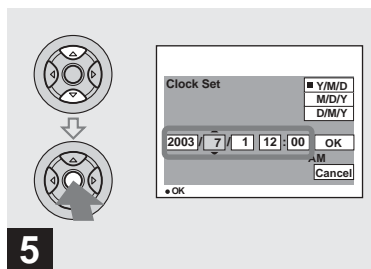

5 → Set the numeric value with ▲/▼ on the control button, then press ● to enter it.

After entering the number, ▲/▼ moves to the next item. Repeat this step until all of the items are set.

- If you selected [D/M/Y] in step **3**, set the time on a 24-hour cycle.

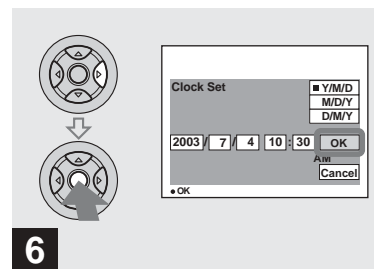

6 → Select [OK] with ▶ on the control button, then press ●.

The date and time are entered and the clock starts to keep time.

- To cancel the date and time setting, select [Cancel] with ▲/▼/◀/▶ on the control button, then press ●.

Inserting and removing a "Memory Stick"

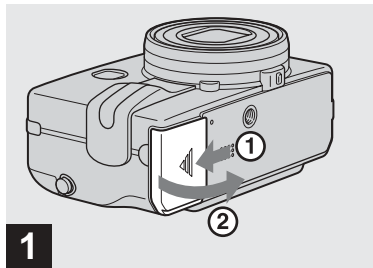

1 → Open the battery/"Memory Stick" cover.

Slide the cover in the direction of the arrow.

- For details on "Memory Stick," see page 119.

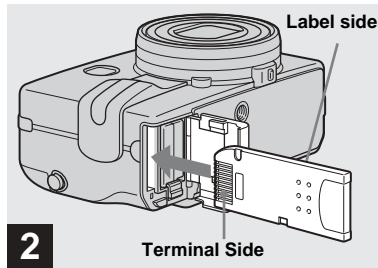

2 → Insert the "Memory Stick."

Insert a "Memory Stick" all the way in until it clicks as illustrated.

- Push the "Memory Stick" all the way in so that it is securely seated in the connector. If the "Memory Stick" is not inserted correctly, you may not be able to record or display images with the "Memory Stick."

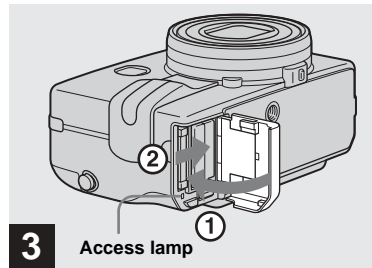



3 → Close the battery/"Memory Stick" cover.

Open the battery/"Memory Stick" cover, then push the "Memory Stick" to pop it out.

- Whenever the access lamp is lit, the camera is recording or reading an image. Never remove the "Memory Stick" or turn off the power at this time. The data may be corrupted.

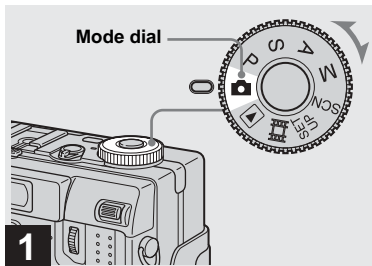
Setting the still image size



➔ Set the mode dial to , and turn on the power.

- You can also carry out this operation when the mode dial is set to P, S, A, M or SCN.

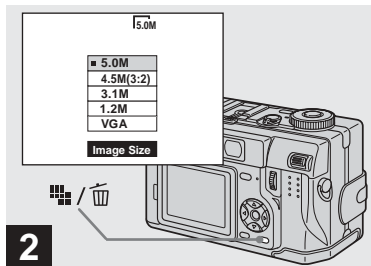

➔ Press  /  (Image Size).

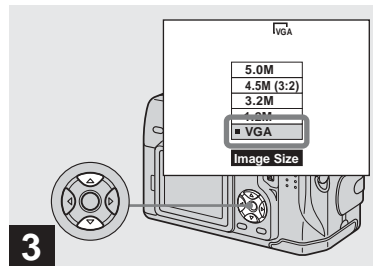

The Image Size setup appears.

- For details on the image size, see page 19.



➔ Select the desired image size with  /  on the control button.

The image size is set.

When the setting is complete, press  /  (Image Size) so that the Image Size setup disappears from the LCD screen.

- The image size selected here is maintained even when the power is turned off.

Image size and quality

You can choose image size (number of pixels) and image quality (compression ratio) based on the kind of images you want to shoot. The larger you make the image size and the higher you make the image quality, the better your image, but also the larger the amount of data needed to preserve your image. This means you can save fewer images in your “Memory Stick.”

Choose an image size and quality level appropriately for the kind of images you want to shoot (pages 18 and 41).

You can resize the images later (Resize function, see page 76).

You can choose image size from among the five options in the following tables. The below image size is a minimum setting for examples. When you want to improve image quality, select the larger image size.

Image size		Examples
5.0M	2592×1944	Very fine prints
4.5M(3:2)	2592 (3:2)	3:2 prints ¹⁾
3.1M	2048×1536	Printing A4 size images
1.2M	1280×960	Printing postcard size images
VGA	640×480	Creating home pages

¹⁾ This option records images in a horizontal to vertical proportion of 3:2 to match the size of the print paper used.

The number of images that can be saved in a “Memory Stick”²⁾

The number of images that can be saved in Fine (Standard)³⁾ mode are shown below.

(Units: number of images)

Capacity Image size	16MB	32MB	64MB	128MB	MSX-256	MSX-512	MSX-1G
5.0M	6 (11)	12 (23)	25 (48)	51 (96)	92 (174)	188 (354)	384 (723)
4.5M(3:2)	6 (11)	12 (23)	25 (48)	51 (96)	92 (174)	188 (354)	384 (723)
3.1M	10 (18)	20 (37)	41 (74)	82 (149)	148 (264)	302 (537)	617 (1097)
1.2M	24 (46)	50 (93)	101 (187)	202 (376)	357 (649)	726 (1320)	1482 (2694)
VGA	97 (243)	196 (491)	394 (985)	790 (1975)	1428 (3571)	2904 (7261)	5928 (14821)

²⁾ When [REC Mode] is set to [Normal]

For the number of images that can be saved in other modes, see page 109.

³⁾ For more information about the image quality mode, see page 41.

- When images recorded using earlier Sony models are played back on this camera, the display may differ from the actual image size.
- When the images are viewed on the LCD screen of the camera, they all look the same size.
- Number of shooting images can differ from these values according to shooting conditions.
- When the number of remaining shooting images is greater than 9999, the “>9999” indicator appears on the LCD screen.

Basic still image shooting (using auto adjustment mode)

Holding the camera correctly



When shooting pictures with the camera, be careful so that your fingers do not block the lens portion, finder window, flash emitter, or infrared ray emitter.

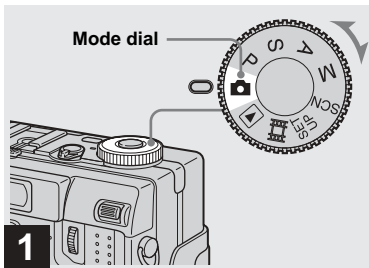

➔ **Set the mode dial to , and turn on the power.**

The name of the folder where the image will be recorded appears on the LCD screen for approximately five seconds.

- The lens cover opens when the power is turned on.
- Do not touch the lens portion while it is operating, such as when you press POWER to turn on the power or when the zoom function is working (page 23).
- This camera can create new folders and select folders to be stored in the “Memory Stick” (page 41).

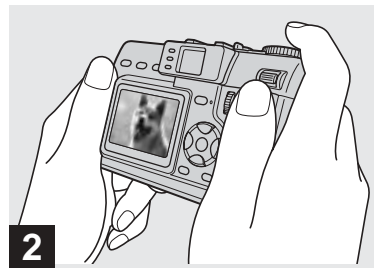

➔ **Hold the camera steadily with both hands and position the subject in the center of the focus frame.**

Hold the camera correctly and shoot the picture.

- The minimum focal distance to a subject is approx. 50 cm (19 3/4 inches). To shoot subjects at distances closer than this, use the macro mode (page 24).

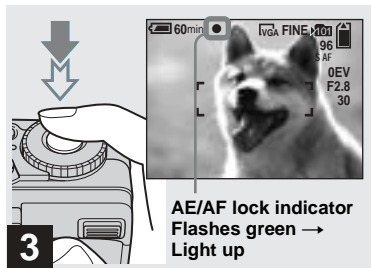

➔ Press and hold the shutter button halfway down.

The beep sounds but the image is not yet recorded. When the AE/AF lock indicator changes from flashing to steadily lit, the camera is ready for shooting. (The LCD screen may be frozen for a split second depending on the subject.) The flash automatically pops up and strobes when the surroundings are dark.

- If you release the shutter button, shooting will be canceled.
- When the camera does not beep, the AF adjustment is not complete. You can continue to shoot, but the AF is not set properly (except in Continuous AF, page 47).

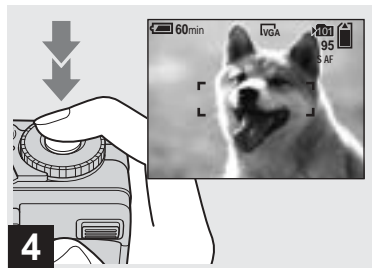

➔ Press the shutter button fully down.

The shutter sounds. The image will be recorded in the "Memory Stick." When the recording lamp (page 9) goes out, you can shoot the next image.

- The frame indicated on the LCD screen shows the focus adjustment range (AF range finder, page 46).
- When operating the camera using a battery pack, if you do not operate the camera for a while during recording or playback, the camera turns off automatically to prevent wearing down the battery (page 14).

Mode dial for still image shooting

When shooting still images with your camera, you can choose from the following shooting methods.

(Auto adjustment mode)

The focus, exposure and white balance are automatically adjusted to allow easy shooting. The image quality is set to [Fine] (page 41).

P (Program auto shooting)

You can set the desired shooting functions using menus (pages 39 and 111). In addition, you can change the combination of the F value and the shutter speed (Program Shift, see page 43).

S (Shutter speed priority)

You can set the desired shooting functions using menus (pages 39 and 111). In addition, you can select the shutter speed (page 44).

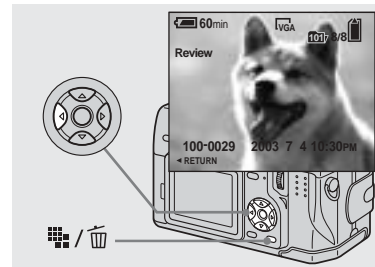

➔ Press ◀ (Ⓢ) on the control button.

To return to the normal shooting mode, press lightly on the shutter button or press ◀ (Ⓢ) again.

To delete the image displayed on the screen

- 1 Press / (Delete).
- 2 Select [Delete] with ▲ on the control button, then press ●. The image is deleted.

A (Aperture priority)

You can set the desired shooting functions using menus (pages 39 and 111). In addition, you can select the aperture value (page 45).

M (Manual)

You can set the desired shooting functions using menus (pages 39 and 111). In addition, you can manually adjust the shutter speed and the aperture value (page 45).

SCN (Scene selection)

You can select from the following modes to shoot according to the scene conditions (page 63).

- (Twilight mode)
- (Twilight portrait mode)
- (Landscape mode)
- (Portrait mode)
- (Snow mode)
- (Beach mode)

Auto Focus

When you try to shoot a subject that is difficult to focus on, the AE/AF lock indicator changes to flashing slowly. The Auto Focus function may have difficulty working under the following conditions. In such cases, release the shutter button, then recompose the shot and focus again.

- The subject is distant from the camera and dark.
- The contrast between the subject and its background is poor.
- The subject is seen through glass, such as a window.
- A fast-moving subject.
- The subject reflects or has a lustrous finish, such as a mirror or a luminous body.
- A flashing subject.
- A backlit subject.

There are two Auto Focus functions: “AF range finder frame” which sets the focus position according to the subject position and size, and “AF mode” which sets the focus operation according to the AF response and the battery consumption. See page 45 for details.

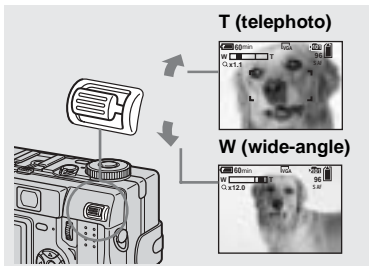

➔ Press the zoom lever up or down to choose the desired image size for shooting.

The minimum focal distance to the subject

Approx. 50 cm (19 3/4 inches) from the lens surface

- The zoom lever directions noted above are the factory settings. The lever directions can be changed by setting the mode dial to SET UP and changing [Zoom Lever] under [📷] (Camera 2) (page 116).
- The lens portion moves during zoom operation. Do not touch the lens portion while it is operating.
- The zoom magnification cannot be changed while shooting movies (page 79).

Smart zoom

Digital processing lets you zoom in the image without deterioration.

When the zoom exceeds 4×, enlargement is carried out using the smart zoom. When the smart zoom is not needed, set [Smart Zoom] to [Off] in the SET UP settings (page 115). When you press the zoom button, the zoom scaling indicator appears on the LCD screen.

Zoom scaling indicator

The T side of this line shows the extent of smart zoom

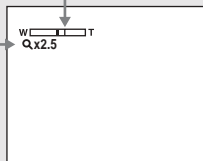

The maximum zoom scale depends on the image size.

[3.1M]: 5.1×

[1.2M]: 8.1×

[VGA]: 16×

When the image size is [5.0M] or [4.5M(3:2)], the smart zoom does not work.

- You cannot confirm the image with the finder when using the smart zoom function.
- When using the smart zoom, the image on the LCD screen may look rough. However, this phenomenon has no effect on the recorded image.
- AF range finder is not shown when using the smart zoom. The AF range finder frame indicator flashes and the centrally-located subject has priority to focus on.



The macro recording mode is used when zooming up a small subject, such as flowers or insects. You can shoot close-ups of subjects up to the distances specified below.

When the zoom is set all the way to the W side:

Approx. 10 cm (4 inches) from the lens surface

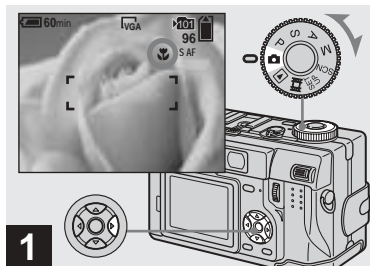

When the zoom is set all the way to the T side:

Approx. 40 cm (15 3/4 inches) from the lens surface



- 1** → Set the mode dial to , and press  (🌸) on the control button.

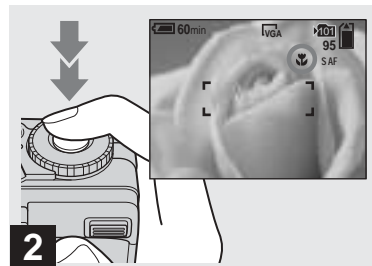

The  (macro) indicator appears on the LCD screen.

- If the menu is currently displayed, press MENU first so that the menu disappears.
- You can also carry out this operation when the mode dial is set to P, S, A, M, SCN (other than  (Twilight mode) or  (Landscape mode), page 63) or .





- 2** → Center the subject in the frame, and press the shutter button fully down.

To return to normal recording mode

Press  (🌸) on the control button again. The  indicator disappears from the LCD screen.

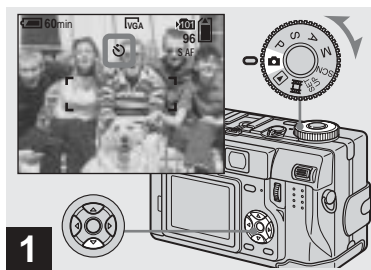
- Use the LCD screen to shoot when using the macro feature. If you use the finder, the limits of what you see and what you actually shoot may be different.



- ➔ **Set the mode dial to , and press  on the control button.**

The  (self-timer) indicator appears on the screen.

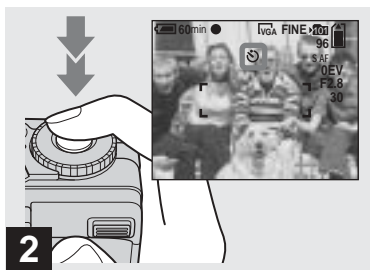

- If the menu is currently displayed, press MENU first so that the menu disappears.
- You can also carry out this operation when the mode dial is set to P, S, A, M, SCN or .



- ➔ **Center the subject in the frame, and press the shutter button fully down.**

The self-timer lamp (page 9) flashes and a beep sounds after you press the shutter button until the shutter operates (approximately 10 seconds later).



To cancel the self-timer in the middle of the operation

Press  on the control button again. The  indicator disappears from the LCD screen.

- If you press the shutter button while standing in front of the camera, the focus and the exposure may not be correctly set.

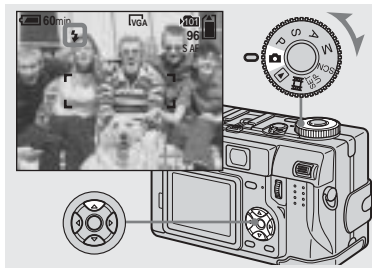
Selecting a flash mode



➔ Set the mode dial to , and press  on the control button repeatedly to select a flash mode.

Each time you press , the indicator changes as follows.







No indicator (Auto): The flash automatically strobos when shooting images in a dark place.

 **(Forced flash):** The flash strobos regardless of the surrounding brightness.

 **(Slow synchro):** The flash strobos regardless of the surrounding brightness.

The shutter speed is slow in a dark place, so you can clearly shoot the background that is out of flash light.

 **(No flash):** The flash does not strobe.

- If the menu is currently displayed, press MENU first so that the menu disappears.
- You can also carry out this operation when the mode dial is set to P, S, A, M, SCN () (Portrait mode)) or  (Clip Motion).
- When [ISO] is set to [Auto] in the menu settings, the recommended shooting distance using the flash is approx. 0.4 m to 2.8 m (15 3/4 inches to 110 3/4 inches) (W)/0.4 m to 2.0 m (15 3/4 inches to 78 3/4 inches) (T)
- You can change the brightness of the flash with [Flash Level] in the menu settings (page 58). (You cannot change the brightness of the flash while the mode dial is set to .)
- When using the  (Slow synchro) or  (No flash) mode, the shutter speed becomes slower in dark places, so using a tripod is recommended.
- While charging the flash, the /CHG lamp flashes. After the charging is complete, the lamp goes out.
- You can mount an external flash on this camera (page 65).
- This setting is maintained even when the power is turned off.

To reduce the red-eye phenomenon when shooting live subjects

Set [Red Eye Reduction] to [On] in the SET UP settings (page 115).  indicator appears on the LCD screen, and the flash pre-strobes before shooting to reduce the red-eye phenomenon.



- Red-eye reduction may not produce the desired effects depending on individual differences, the distance to the subject, if the subject does not see the pre-strobe, or other conditions.

Recording images with the hologram AF

The hologram AF is fill light to focus more easily on a subject in dark surroundings. When not using this function, set [Hologram AF] to [Off] in the SET UP settings (page 115).

☞_{CON} appears on the screen and the hologram AF emits red light when the shutter button is pressed halfway until the focus is locked.



- If hologram AF light does not reach the subject sufficiently or the subject has weak contrast, focus will not be achieved. (An approximate distance of 0.5 m to 2.8 m (19 3/4 inches to 110 1/4 inches) (W)/0.5 m to 2.5 m (19 3/4 inches to 98 1/2 inches) (T) is recommended.)
- Focus is achieved as long as hologram AF light reaches the subject, even if the light is slightly off the center of the subject.
- When the focus preset distance is set (page 48), the hologram AF does not function.

- If the hologram AF emitter is dirty, the hologram AF light may be dimmed and focus may not be achieved. In this case, wipe the hologram AF emitter with a dry cloth.
- The hologram AF emitter emits very bright light. Although there are no problems with safety, directly looking into the hologram AF emitter at close range is not recommended.
- Do not block the hologram AF emitter during recording.
- The AF range finder frame is not displayed. AF range finder frame indicator flashes and the centrally-located subject has priority to focus on.
- When you mount an adaptor ring (not supplied) or telephoto end conversion lens (not supplied) to the camera, the hologram AF light is blocked. We recommend using hologram AF together with the Sony HVL-F32X flash.
- The hologram AF does not function when SCN is set to ☾ (Twilight mode) or ▲ (Landscape mode).

About Hologram AF

“Hologram AF (Auto-Focus)” is an AF fill light system that applies laser holograms to enable you to shoot still images in dark places. The Hologram AF system uses gentler radiation than conventional high-brightness LEDs or lamps, thus satisfying Laser Class 1* specifications and maintaining higher safety for human eyes.

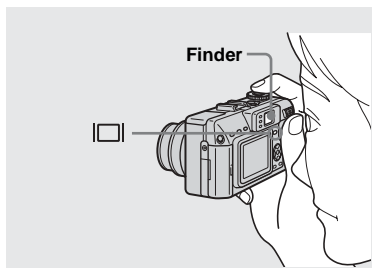

* Hologram AF satisfies Class 1 (time base 30 000 seconds), specified in JIS (Japan), IEC (EU), and FDA (US) industry standards. Complying with these standards identifies the laser product as safe, under the condition that a human can look at the laser light either directly or focused through a lens for 30 000 seconds.

Shooting images with the finder

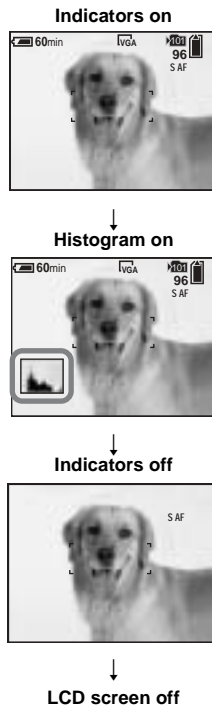

The finder is convenient when you want to save battery power, or when it is difficult to confirm the image using the LCD screen. Each time you press , the display changes in the following order.



- The image through the finder does not indicate the actual recordable range. To confirm the recordable range, use the LCD screen.
- Just as with the AE/AF lock indicator on the LCD screen, when the AE/AF lock lamp of the finder section stops flashing and remains on, you can start shooting (page 21).
- When the LCD screen is turned off:
 - The smart zoom does not function (page 23).
 - The AF Mode is set to [Single] (page 47).
 - If you press  (Flash mode)/ (Self-timer)/ (Macro), the image will be displayed on the LCD screen for approximately two seconds so you can check or change the setting.
- For a detailed description of the indicators, see page 124.
- For a detailed description of the histogram, see page 50.
- This setting is maintained even when the power is turned off.

Inserting the date and time on a still image

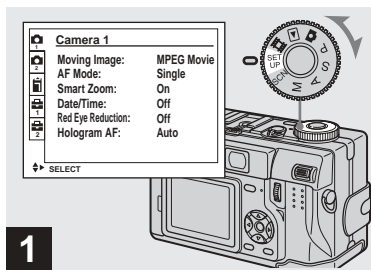

1



➔ Set the mode dial to SET UP.

The SET UP screen appears.

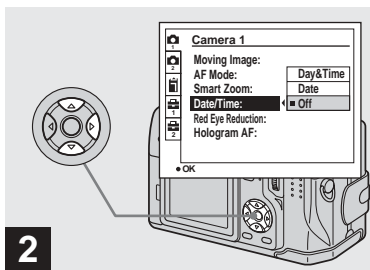
- When images are shot with the date and time superimposed, the date and time cannot be removed later.
- The date and time do not appear on the LCD screen during shooting, instead, **DATE** indicator appears in the upper left corner of the LCD screen. The actual date and time appear in red during playback only.
- You can also carry out this operation with the mode dial set to P, S, A, M or SCN.



2

➔ Select  (Camera 1) with ▲ on the control button, then press .

Select [Date/Time] with ▲/▼, then press .

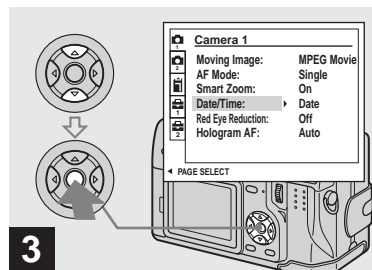

3

➔ Select the date and time setting with ▲/▼ on the control button, then press .

Day & Time: Superimposes the date, hour, and minute onto the image.

Date: Superimposes the year, month and day onto the image.

Off: Does not superimpose the date and time onto the image.

After the setting has been completed, set the mode dial to , and shoot the image.

- If you select [Date], the date is superimposed onto the image in the order selected in “Setting the date and time” (page 15).
- This setting is maintained even when the power is turned off.

Viewing images on the LCD screen of your camera

Single (single-image) screen



You can view images shot with your camera almost immediately on the screen. You can select the following three methods for viewing images.

Single (single-image) screen

You can view one image at a time, displayed over the entire screen.

Index (nine-image) screen

Nine images are displayed simultaneously in separate panels on the screen.

Index (nine-image) screen



Index (triple-image) screen

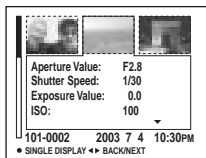



Index (triple-image) screen

Three images are displayed simultaneously in separate panels on the screen. Various image information items are also displayed.

- You can switch the displayed image to the previous image or the next image by turning the jog dial.
- For details on viewing movies, see page 80.
- For a detailed description of the indicators, see page 126.

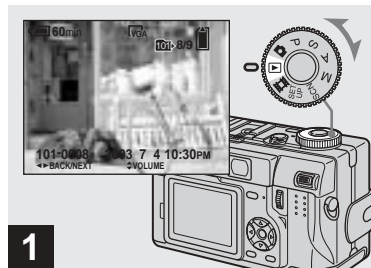
Viewing single images



➔ **Set the mode dial to , and turn on the power.**

The last image in the selected recording folder (page 68) appears on the screen.

Viewing an index screen (nine-image or triple-image)

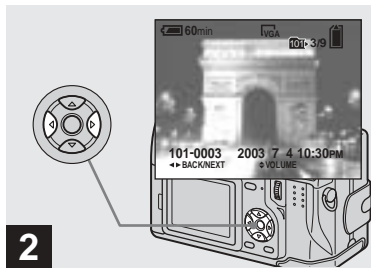

➔ **Select the desired still image with ◀/▶ on the control button.**

- ◀: To display the preceding image
- ▶: To display the next image

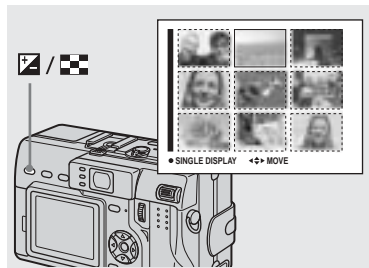

➔ **Press [Index] button once.**

The display switches to the **index (nine-image) screen**.

To display the next (previous) index screen

Press ▲/▼/◀/▶ on the control button to move the yellow frame up/down/left/right.

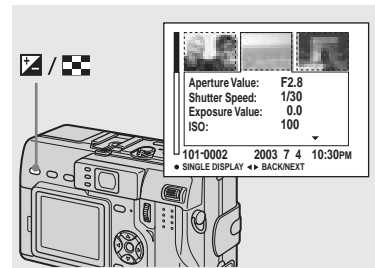

➔ **Press [Index] button once more.**

The display switches to the **index (triple-image) screen**.

Press ▲/▼ on the control button to display the remaining image information.

To display the next (previous) index screen

Press ◀/▶ on the control button.

To return to the single-image screen

Press [Index] repeatedly, or press ● on the control button.

Viewing images on a TV screen

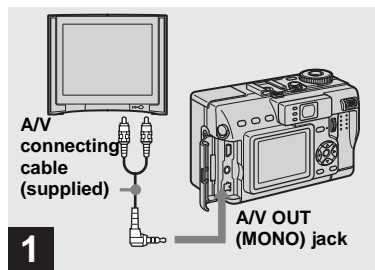

- ➔ **Connect the supplied A/V connecting cable to the A/V OUT (MONO) jack of the camera and the audio/video input jacks of the TV.**

If your TV has stereo input jacks, connect the audio plug (black) of the A/V connecting cable to the left audio jack.

- Turn off both your camera and the TV before connecting the camera and the TV with the A/V connecting cable.
- We recommend using the AC Adaptor (supplied) to prevent the power from turning off partway.

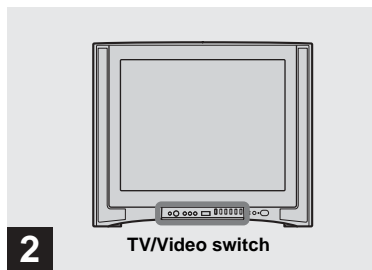

- ➔ **Turn on the TV and set the TV/Video switch to “Video”.**

- The name and location of this switch may differ depending on your TV. For details, see the operating instructions supplied with the TV.

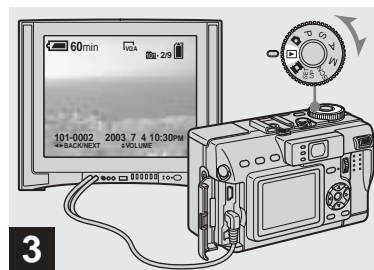

- ➔ **Set the mode dial to , and turn on the camera.**

Press  on the control button to select the desired image.

- When using your camera abroad, it may be necessary to switch the video output signal to match that of your TV system (page 117).

Viewing images on a TV screen

If you want to view images on a TV screen, you need a TV with a video input jack and the A/V connecting cable (supplied). The color system of the TV must match that of your digital still camera. Check the following lists:

NTSC system

Bahama Islands, Bolivia, Canada, Central America, Chile, Colombia, Ecuador, Jamaica, Japan, Korea, Mexico, Peru, Surinam, Taiwan, the Philippines, the U.S.A., Venezuela, etc.

PAL system

Australia, Austria, Belgium, China, Czech Republic, Denmark, Finland, Germany, Holland, Hong Kong, Italy, Kuwait, Malaysia, New Zealand, Norway, Portugal, Singapore, Slovak Republic, Spain, Sweden, Switzerland, Thailand, United Kingdom, etc.

PAL-M system

Brazil

PAL-N system

Argentina, Paraguay, Uruguay

SECAM system

Bulgaria, France, Guiana, Hungary, Iran, Iraq, Monaco, Poland, Russia, Ukraine, etc.

Deleting images

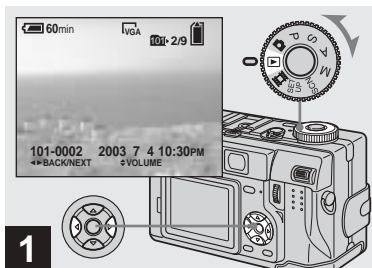

- Set the mode dial to **P**, and turn on the camera. Press **◀/▶** on the control button to select the image you want to delete.

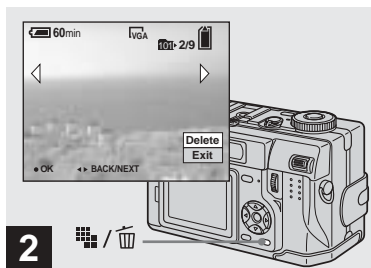

- Press **⏏/🗑** (Delete).

The image has not yet been deleted at this point.

- You cannot delete the protected image (page 74).

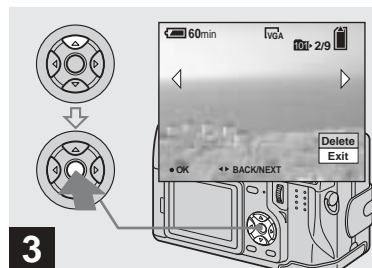

- Select **[Delete]** with **▲** on the control button, then press **●**.

When the message “Memory Stick access” disappears, the image has been deleted.

To continue and delete other images



Display the image to be deleted with **◀/▶** on the control button. Then, select **[Delete]** with **▲** and press **●**.

To cancel deleting

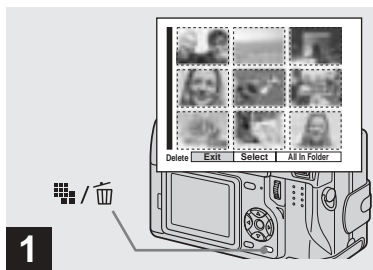

Select **[Exit]** with **▼** on the control button, then press **●**.



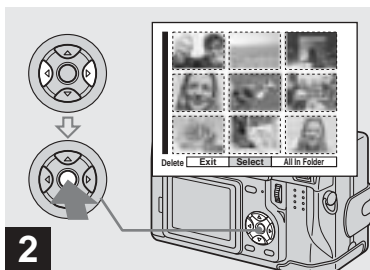

Deleting images in index (nine-image) mode



→ While an index (nine-image) screen (page 31) is displayed, press  /  (Delete).



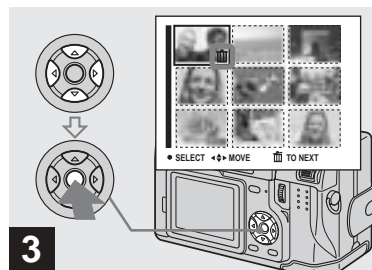

→ Select [Select] with  /  on the control button, then press .

To delete all the images in the folder Select [All In Folder] with  on the control button, then press . Select [OK], then press . All of the unprotected images in the folder are deleted. To cancel deleting, select [Cancel], then press .







→ Select an image you want to delete with  /  /  /  on the control button, then press .

The green  (Delete) indicator appears on the selected image. At this point, the image has not yet been deleted. Repeat this step for all of the images you want to delete.

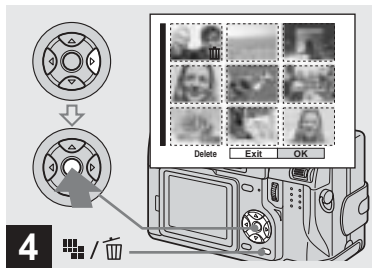
- To cancel a selection, press  again so that the  indicator disappears.



Deleting images in index (triple-image) mode





- Press  /  (Delete) and select [OK] with  on the control button, then press .

When the message “Memory Stick access” disappears, the images have been deleted.

To cancel deleting

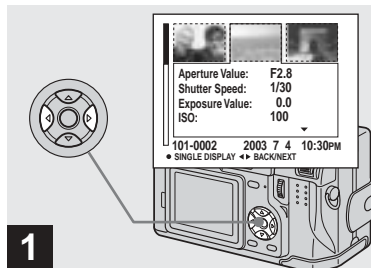
Select [Exit] with  on the control button, then press .



- While an index (triple-image) screen (page 31) is displayed, set the image you want to delete to the center with  /  on the control button.

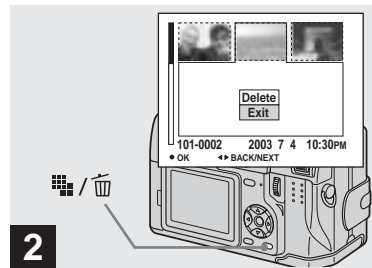

- Press  /  (Delete).

The image has not yet been deleted at this point.

Formatting a "Memory Stick"

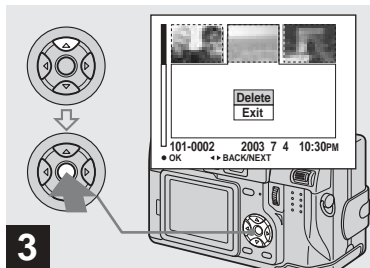

➔ Select [Delete] with ▲ on the control button, then press ●.

When the message "Memory Stick access" disappears, the image has been deleted.

To cancel deleting

Select [Exit] with ▼ on the control button, then press ●.

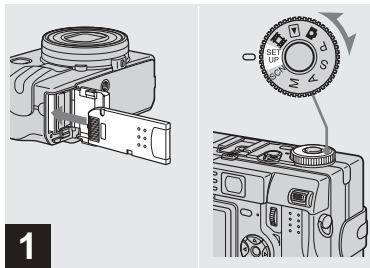

➔ Insert the "Memory Stick" you want to format into the camera. Set the mode dial to SET UP, and turn on the power.

- The term "formatting" means preparing a "Memory Stick" to record images; this process is also called "initialization." The "Memory Stick" provided with this camera, and those available commercially, are already formatted, and can be used immediately.
- When you format a "Memory Stick," be aware that all data including protected images in the "Memory Stick" will be permanently erased.

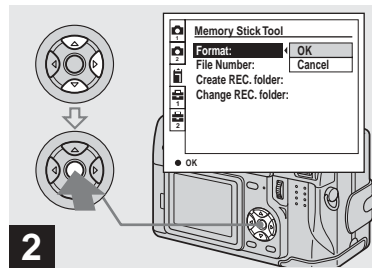

➔ Select  (Memory Stick Tool) with ▲/▼ on the control button. Select [Format] with ►, then press ►. Select [OK] with ▲, then press ●.

To cancel the formatting

Select [Cancel] with ▼ on the control button, then press ●.

- Using the AC Adaptor is recommended to prevent the power from turning off partway through formatting.

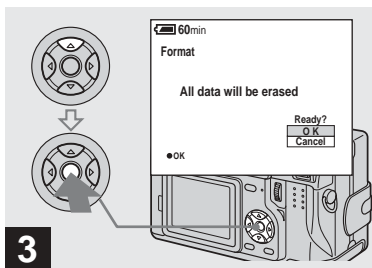

➔ **Select [OK] with ▲ on the control button, then press ●.**

The “Formatting” message appears. When this message disappears, the format is complete.

How to setup and operate your camera

The usage of the menus and SET UP screen items that are most frequently used for “Advanced operations” is described below.

Control button

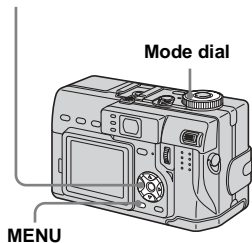

Changing the menu settings

1 Press MENU.

The menu appears.

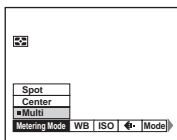

2 Press ◀/▶ on the control button to select the item you want to set.

The selected item turns yellow.

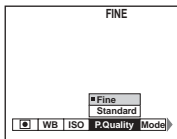

3 Press ▲/▼ on the control button to select the desired setting.

The frame of the selected setting turns yellow, and the setting is entered.

To turn off the menu display

Press MENU.

Changing the items in the SET UP screen

1 Set the mode dial to SET UP.

The SET UP screen appears.

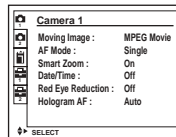

2 Press ▲/▼/◀/▶ on the control button to select the item you want to set.

The frame of the selected item turns yellow.

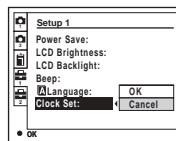

3 Press ● on the control button to enter the setting.

To turn off the SET UP screen display

Set the mode dial to anything other than SET UP.

How to use the jog dial

The jog dial is used to change the setting values when shooting with the manual adjustment modes (shutter speed priority mode, aperture priority mode, manual exposure mode), EV adjustment, focusing manually or choosing AF range finder frame.

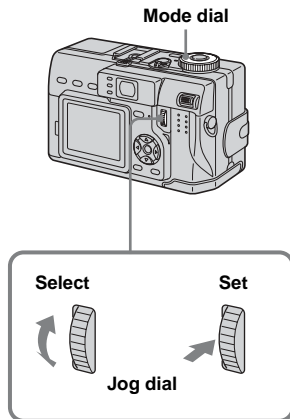

To select the item

1 Turn the jog dial to select the item you want to set.

Move the yellow indication ◀ to select the item.

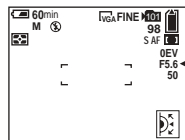

2 Press the jog dial.

The value turns yellow.

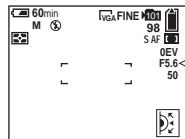

3 To set other items, press the jog dial and then perform the following operations.

- Items that cannot be selected are displayed as gray.

To select the value

You can select values that are displayed in yellow.

Turn the jog dial to select the value you want to set

The displayed value is set.

Deciding the still image quality

Mode dial: P/S/A/M/SCN

You can select the still image quality from [Fine] or [Standard].

Control button

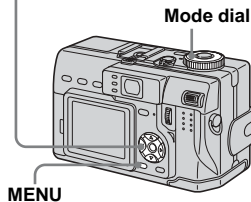

1 Set the mode dial to P, S, A, M or SCN.

2 Press MENU.

The menu appears.

3 Select (P. Quality) with , then select the desired image quality with /▼.

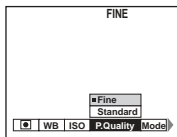

- You can also carry out this operation when the mode dial is set to (Multi Burst) (page 60).
- This setting is maintained even when the power is turned off.

Creating or selecting a folder

Mode dial: SET UP

Your camera can create multiple folders within a “Memory Stick”. You can select the folder used to store images.

When not creating a new folder, “101MSDCF” folder is selected as the recording folder.

You can create folders up to “999MSDCF.”

Control button

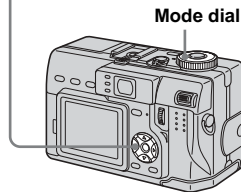

- Up to 4000 images can be stored in one folder. When the folder capacity is exceeded, a new folder is automatically created.

Creating a new folder

- 1 Set the mode dial to SET UP.
- 2 Select  (Memory Stick Tool) with $\blacktriangle/\blacktriangledown$, [Create REC. Folder] with $\blacktriangleright/\blacktriangle/\blacktriangledown$, and [OK] with $\blacktriangleright/\blacktriangle$, then press \bullet .

The following screen appears.



- 3 Select [OK] with \blacktriangle , then press \bullet .

A new folder is created with a number one higher than the largest number in the “Memory Stick”, and the folder becomes the recording folder.

To cancel folder creation

Select [Cancel] in step **2** or **3**.

- Once you create a new folder, you cannot delete the new folder with the camera.
- Images are recorded in the newly created folder until a different folder is created or selected.

Changing the recording folder

- 1 Set the mode dial to SET UP.
- 2 Select  (Memory Stick Tool) with $\blacktriangle/\blacktriangledown$, [Change REC. Folder] with $\blacktriangleright/\blacktriangle/\blacktriangledown$, and [OK] with $\blacktriangleright/\blacktriangle$, then press \bullet .

The recording folder selection screen appears.

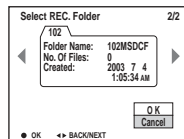

- 3 Select the desired folder with $\blacktriangle/\blacktriangleright$, and [OK] with \blacktriangle , then press \bullet .

To cancel changing the recording folder

Select [Cancel] in step **2** or **3**.

- You cannot select the “100MSDCF” folder as a recording folder.
- The image is stored in the newly selected folder. You cannot move images to a different folder with this camera.

Shooting with Program Shift

— Program Shift

Mode dial: P

Program Shift lets you quickly change the F value (aperture value) and shutter speed combination while keeping the brightness fixed.

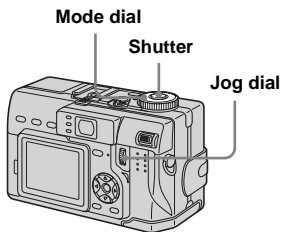

1 Set the mode dial to P.

2 Shift the F value and shutter speed combination.

Select the F value and shutter speed combination with the jog dial (page 40). P* is indicated while the F value and shutter speed combination is shifted.

To cancel Program Shift

Perform any of the following operations.

- Turn the jog dial to return the indication from P* to P.
- Set the mode dial to other than P.
- Turn off the power.
- You cannot shift the F value and shutter speed combination when the shutter button is pressed halfway down.
- When the brightness changes, the F value and shutter speed also change while maintaining the shift amount.
- When the flash mode setting is changed, Program Shift may be canceled.
- You may not be able to shift the F value and shutter speed combination in dark locations.



Shooting with the manual adjustments

Mode dial: S/A/M

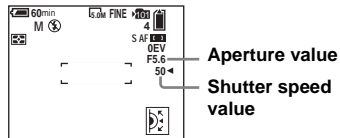
You can manually adjust the shutter speed and aperture values according to the purpose of shooting.



Mode dial	Description
S	Shutter speed priority mode. Other settings are automatically adjusted to attain correct exposure according to the brightness of the subject.
A	Aperture priority mode. Other settings are automatically adjusted to attain correct exposure according to the brightness of the subject.
M	Mode for manually adjusting both the shutter speed and aperture values to achieve the desired shooting condition.

- You cannot use the NightShot or NightFraming functions when the mode dial is set to S, A or M.
- You cannot make manual adjustments when shooting movies.
- If the proper exposure is not obtained after making the settings, the setting value indicators on the screen may flash when the shutter button is pressed halfway down. You can shoot in this condition, but we recommend that you adjust the flashing values again.
- The flash is set to  (Forced flash) or  (No flash).
- You can adjust an exposure value when the mode dial is set to S or A (page 49).

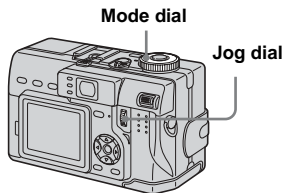

Shutter speed priority mode

This function lets you shoot a fast-moving subject with its motion frozen, or the flow motion of a moving subject.



1/1000 s (shortest) 30 s (longest)

1 Set the mode dial to S.

2 Select a shutter speed value.

Select a shutter speed with the jog dial (page 40). The shutter speed can be selected from 1/1000 to 30 seconds. If you select certain shutter speeds*, NR slow shutter function is automatically activated.

- * When [ISO] is [800]:
Shutter speeds of 1/25 second or slower
- When [ISO] is other than [800]:
Shutter speeds of 1/6 second or slower

- Shutter speeds of one second or longer are indicated with ["] after the value, such as 1".

NR slow shutter

The NR slow shutter function removes noise from recorded images, providing clear images. When using certain shutter speeds*, the NR slow shutter function activates automatically and "NR" appears before the shutter speed indication.

- * When [ISO] is [800]:
Shutter speeds of 1/25 second or slower
- When [ISO] is other than [800]:
Shutter speeds of 1/6 second or slower



Press the shutter button fully down.

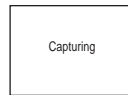

Then the screen turns black.

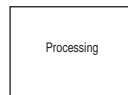

Finally, when "Processing" disappears, the image has been recorded.

- To eliminate the effects of vibration, use of a tripod is recommended.
- When a slow shutter speed is set, processing may take some time.

Aperture priority mode

This function lets you change the focus depth to bring both the subject and background into focus or to shoot a subject with a fuzzy background.



Aperture value F2.8
(minimum)

Aperture value F8
(maximum)

1 Set the mode dial to A.

2 Select an aperture value.

Select an aperture value with the jog dial (page 40). The aperture value can be selected from F2.8 to F8.

- The range of values that can be selected varies, depending on the zoom position.
- The shutter speed is automatically adjusted from 1/1000 to 8 seconds. When you set an aperture value of F5.6 or more, the values start from 1/2000 second.

Manual exposure mode

You can manually adjust the shutter speed and aperture values to achieve the desired shooting condition according to your purpose.



The difference between the set value and the appropriate exposure determined by the camera is displayed on the screen as the EV value (page 49). 0EV indicates that the most suitable value has been set by the camera.

1 Set the mode dial to M.

2 Select the shutter speed value.

Select the shutter speed value with the jog dial (page 40).

3 Select the aperture value.

Select the aperture value with the jog dial (page 40).

Choosing an auto focus method

You can set the AF range finder frame and the AF mode.

AF range finder frame

The AF range finder frame selects the focus position according to the subject position and size.

AF Mode

The AF mode sets the focus operation according to the AF response and the battery consumption.

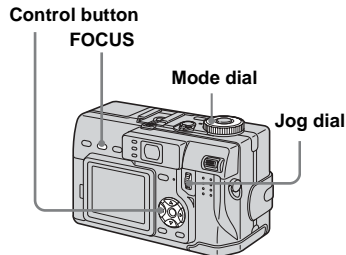

Choosing a focus range finder frame

— AF range finder

Mode dial: P/S/A/M/SCN/

Multipoint AF ()

The camera calculates the distance in three places to the left and right and in the center of the image, letting you shoot using the auto focus function without worrying about the image composition. This is useful when it is difficult to focus on the subject because it is not in the center of the frame. You can check the position where the focus was adjusted using the green frame. The Multipoint AF is the factory setting.

Selected frame priority AF (), (), (), ()

You can select from five different AF range finder frames (Center, Left, Right, Bottom or Top). This is useful when focusing on a subject near the selected frame. Use together with the AF lock function lets you shoot in the desired image composition.

Spot AF ()

This is useful when focusing on an extremely small subject or a narrow area. Use together with the AF lock function lets you shoot in the desired image composition. Take care to hold the camera steady so that the subject does not deviate from the range finder frame.

1 Set the mode dial to P, S, A, M, SCN or .

2 Press FOCUS to switch to AF range finder frame select.

Each time you press FOCUS, the setting changes in the following order.
AF range finder frame select



Focus preset

3 Select the desired AF range.

Select the AF range with the jog dial (page 40).

You can select the AF range from Multipoint AF, Center, Left, Right, Bottom, Top and Spot AF.



AF range finder frame

The focus is adjusted automatically.

When you press and hold the shutter button halfway down and the focus is adjusted, the color of the AF range finder frame changes from white to green.

- When you are shooting movies (MPEG Movie) and you choose Multipoint AF, the distance to the center of the screen is estimated as an average, so the AF works even with a certain amount of vibration. Selected frame priority AF and Spot AF automatically focus only on selected frame, so these are convenient when you want to focus only on what you aim at.
- When you use the smart zoom or hologram AF, priority AF movement is given to subjects in or near the center of the frame. In this case, AF range finder frame indicator flashes and the AF range finder frame is not displayed.

Choosing a focus operation

— AF Mode

Mode dial: SET UP

You can select from the following three focus modes for your camera.

Single AF (S AF)

This mode allows accurate focusing over a wide range from near to distant subjects, and is useful for shooting stationary subjects. The focus is not adjusted before the shutter button is pressed and held halfway down. When the shutter button is pressed and held halfway down and AF lock is complete, the focus is locked.

The factory setting is Single AF.

Monitoring AF (M AF)

This shortens the time needed for focusing. The camera adjusts the focus before the shutter button is pressed and held halfway down, letting you compose images with the focus already adjusted. When the shutter button is pressed and held halfway down and AF lock is complete, the focus is locked.

- Battery consumption may be faster than in Single AF mode.

Continuous AF (C AF)

The camera adjusts the focus before the shutter button is pressed and held halfway down, and then continues to adjust the focus even after AF lock is completed. This allows shooting of moving subjects with continued focus.

- The focus is not adjusted after the lock is completed in the following cases, and the C AF indicator flashes. The camera operates in Monitoring AF mode.
 - When shooting in the dark place
 - When shooting with a slow shutter speed
 - When using the NightShot/NightFraming functions
- The AF range finder frame is locked to the center.
- Focus adjustment may not be able to keep up when shooting fast moving subjects.
- There is no lock sound when the focus is adjusted.
- When recording with the self timer, the focus is locked when you press the shutter button all the way down.
- Battery consumption may be faster than in any other AF mode.

1 Set the mode dial to SET UP.

2 Select (Camera 1) with ▲, [AF Mode] with ►/▲/▼.

3 Select the desired mode with ►/▲/▼, then press ●.

- When shooting in Macro mode, the AF speed drops in order to focus accurately on close subjects. For quicker shooting, using a different mode than Macro mode is recommended.
- When shooting using the finder with the LCD screen off, the camera operates in Single AF mode.

Shooting techniques

When shooting with the subject at the edge of the frame, the camera may focus on the center instead of on the subject at the edge of the frame. In a case like this, use AF lock to focus on the subject, and then recompose the picture and shoot (except in Continuous AF mode).

Compose the shot so that the subject is centered in the AF range finder, and press the shutter button halfway down.

When the AE/AF lock indicator stops flashing and remains on, return to the fully composed shot, and press the shutter button fully down.

AE/AF lock indicator



AF range
finder frame



- When you are using AF lock, you can capture an image with the correct focus even if the subject is at the edge of the frame.
- You can carry out the AF lock adjustment process before you press the shutter button fully down.

Setting the distance to the subject

— Focus preset

Mode dial: P/S/A/M/SCN

When shooting an image using a previously set distance to the subject, or when shooting a subject through a net or through window glass, it is difficult to get the proper focus in auto focus mode. In these cases, use of the Focus preset is convenient.

FOCUS

Mode dial

Jog dial

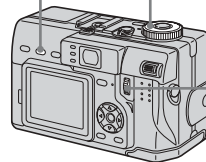

1 Set the mode dial to P, S, A, M, SCN, or .

2 Press FOCUS to switch to focus preset.

Each time you press FOCUS, the setting changes in the following order.

Focus preset



AF range finder frame select

The focus is fixed and the  (manual focus) indicator appears.

3 Turn the jog dial to select the desired focus setting.

You can select from the following distance settings:

0.1 m, 0.2 m, 0.3 m, 0.5 m, 0.8 m, 1.0 m, 1.5 m, 2.0 m, 3.0 m, 5.0 m, 7.0 m, 10 m, 15 m, and ∞ (infinity)

To reactivate auto focusing

Press FOCUS again so that the focus setting information disappears.

- Focus setting information is approximate, and should be used as a reference.
- If you point the lens up or down, the error will increase.
- When you select 0.1 m, 0.2 m, 0.3 m with the zoom set to the T side, you may not get a clear focus. In such cases, the focus setting information flashes. Press the zoom W button until the indicator stops flashing.
- The focus preset does not work properly when attaching a conversion lens (not supplied).

Adjusting the exposure

— EV adjustment

Mode dial: P/S/A/SCN 

This lets you adjust the exposure value which is set by automatic adjustment. You can select values ranging from +2.0EV to -2.0EV in steps of 1/3EV.

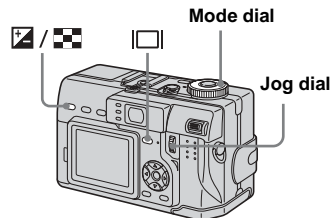

1 Set the mode dial to P, S, A, SCN or .

2 Press / (Exposure).

3 Select the desired exposure value with the jog dial.

Adjust the exposure value while checking the brightness of the background.



To reactivate auto exposure

Return the exposure adjustment value to 0EV.

- If a subject is being shot in extremely bright or dark conditions, or the flash is used, the exposure adjustment may not be effective.

Shooting techniques

Normally, the camera automatically adjusts the exposure. If the image is too dark or too bright as shown below, we recommend that you adjust the exposure manually. When shooting a back-lit subject or a subject against a white (e.g. snowy) background, adjust the exposure toward the + side. When shooting a black subject that fills the screen, adjust the exposure toward the - side.



Underexposed
→ Adjust toward +



Appropriate exposure



Overexposed
→ Adjust toward -

Displaying a histogram

A histogram is a graph showing the brightness of an image. The horizontal axis shows the brightness, and the vertical axis shows the number of pixels. The graph display indicates a dark image when skewed to the left side, and a bright image when skewed to the right side. The histogram is a useful reference for checking the exposure during recording and playback without being affected by the brightness of the LCD screen.





- 1** Set the mode dial to P, S, A, M or SCN.
- 2** Press  to display the histogram.
- 3** Adjust the exposure based on the histogram.

Adjusting the exposure to the + side shifts the histogram to the right side.



Adjusting the exposure to the – side shifts the histogram to the left side.



- The histogram also appears when the mode dial is set to , but you cannot adjust the exposure.
- The histogram also appears when you press  while playing back a single image (page 30) or during Quick Review (page 22).
- The histogram does not appear in the following cases:
 - When the menu is displayed
 - During Quick Review of an image recorded in Exposure Bracket mode
 - When using playback zoom
 - When playing back an image recorded with the mode dial set to 

-  appears in the following cases:
 - When recording in the smart zoom range
 - When the image size is [4.5M (3:2)]
 - When rotating a still image
- The histogram before recording represents the histogram of the image displayed on the screen at that time. A difference occurs in the histogram before and after you press the shutter button. When this happens, check the histogram while playing back a single-image or during Quick Review.

In particular a large difference may appear in the following cases:

- When the flash strobes
 - When using the NightFraming function
 - When [P. Effect] is set to [Solarize]
 - When the shutter speed is slow or high
- The histogram may not appear for images recorded using other cameras.

Selecting the metering mode

Mode dial: P/S/A/M/SCN 

This function enables you to select the metering mode to suit the shooting conditions and purpose.

Multi-pattern metering ()

The image is divided into multiple regions and metering is performed for each region. The camera judges the subject position and background brightness, and determines a well-balanced exposure.

The factory setting is multi-pattern metering.

Center-weighted metering ()

Metering is performed with priority given to the center of the image. The camera determines the exposure based on the brightness of a subject near the center according to the shooting aim.

Spot metering (☐)

Light is measured only for the specific region where the subject is located. This lets you adjust the exposure to the subject even when the subject is backlit or there is strong contrast between the subject and the background.

Position the spot metering cross hair on one point of the subject you want to shoot.

- When using center weighted metering or spot metering, to focus on the same spot as used for metering, we recommend using the center weighted AF range finder frame (page 46).

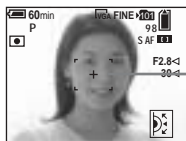



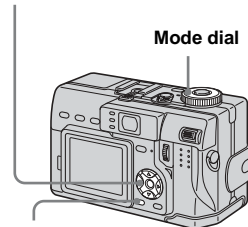

Spot metering cross hair

Control button

Mode dial



MENU

- 1** Set the mode dial to P, S, A, M, SCN or .
- 2** Press MENU.
The menu appears.
- 3** Select  (Metering Mode) with , then select [Multi], [Center] or [Spot] with .

Shooting with the exposure fixed

— AE LOCK

Mode dial: P/S/A/SCN/

Once you press AE LOCK, the exposure is fixed.

AE LOCK

Mode dial
Shutter

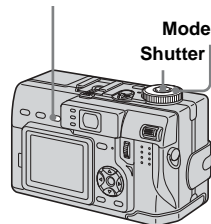

- 1** Set the mode dial to P, S, A, SCN or .
- 2** Focus on a portion of the image that has the desired exposure value, then press AE LOCK.

The exposure is fixed and the AE-L indicator appears.

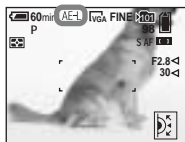

3 Target the subject you want to shoot and press and hold the shutter button halfway down.

The focus is automatically adjusted.

4 Press the shutter button fully down.

To release AE LOCK

Carry out one of the followings:

- Press AE LOCK again after step **2**.
- Release your finger from the shutter button after step **3**.
- Press down the shutter button in step **4**.

Shooting techniques

You can shoot with the exposure locked to a specific portion of the image.

Measure the exposure of the desired portion of the subject using the center weighted metering or spot metering function. Press AE LOCK to lock the exposure, and then recompose the picture and shoot.

Portion of the image used to determine the exposure



Shooting three images with the exposure shifted

— Exposure Bracket

Mode dial:  /P/S/A/M/SCN

The camera records three images in succession, each with the exposure value shifted. The exposure compensation value can be set between $\pm 1.0\text{EV}$ from the appropriate exposure value in 1/3EV steps.

Control button

Mode dial

Shutter

MENU

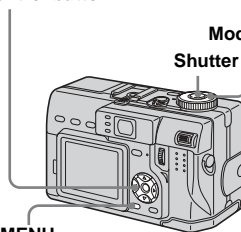



1 Set the mode dial to SET UP.

The SET UP screen appears.

2 Select  (Camera 2) with ▲/▼ and [Bracket Step] with ►/◄, then press ►.

3 Select the desired bracket step value with ▲/▼, then press ●.

±1.0EV: Shifts the exposure value by plus or minus 1.0EV.

±0.7EV: Shifts the exposure value by plus or minus 0.7EV.

±0.3EV: Shifts the exposure value by plus or minus 0.3EV.

4 Set the mode dial to , P, S, A, M or SCN.

5 Press MENU.

The menu appears.

6 Select [Mode] (REC Mode) with ◀/▶, then select [Exp Brktg] with ▲/▼.

7 Shoot the image.

To return to normal mode

Select [Normal] in step **6**.

- You cannot use the flash in this mode.
- During shooting in this mode, the images are not displayed on the screen. Compose the image before pressing the shutter button.
- The focus and white balance are adjusted for the first image, and these settings are also used for the other images.
- When the exposure is manually adjusted (page 49), the adjusted value is used for the center value.
- The recording interval is approximately 0.5 second.
- If the subject is too bright or too dark, you may be unable to shoot properly with the selected bracket step value.
- You cannot select certain shutter speeds*.

* When [ISO] is [800]:

Shutter speeds of 1/25 second or slower

When [ISO] is other than [800]:

Shutter speeds of 1/6 second or slower

Adjusting color tones

— White Balance

Mode dial: P/S/A/M/SCN/☰

When the white balance is set to Auto, the white balance is automatically set and the overall color balance is adjusted according to the shooting conditions. However, when you shoot under fixed conditions or special lighting conditions, you can manually adjust the white balance.

Auto (no display)

Adjusts the white balance automatically

☀ (Daylight)

Shooting outdoors, shooting night scenes, neon signs, fireworks or sunrise, or shooting just before and after sundown

☁ (Cloudy)

Shooting under a cloudy sky

☀ (Fluorescent)

Shooting under fluorescent lighting

☀ (Incandescent)

- Places where the lighting conditions change quickly
- Under bright lighting such as photography studios

☀WB (Flash)

Adjusts the white balance only to the flash conditions

☰ (One push)

For adjusting the white balance depending on the light source

Control button

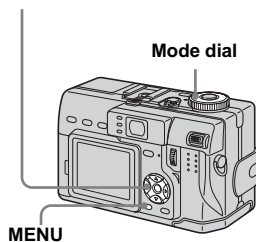

1 Set the mode dial to P, S, A, M, SCN or ☰.

2 Press MENU.

The menu appears.

3 Select [WB] (White Bal) with ◀/▶, then select the desired setting with ▲/▼.

To reactivate auto adjustment

Select [Auto] in step **3**.

- Under fluorescent lights that flicker, the white balance adjustment function may not work correctly even though you select ☰ (Fluorescent).
- When the flash strobes, the manual setting is canceled, and the image is recorded in [Auto] mode (except in ☀WB (Flash) mode or ☰ (One push) mode).

To shoot in one-push white balance mode

1 Select [☰] (One push).

The ☰ indicator appears.

2 Frame a white object such as a piece of paper filling the screen under the same lighting conditions as you will shoot the subject.

3 Press ▲.

The ☰ indicator flashes quickly.

When the white balance has been adjusted and stored in the memory, the indicator stops flashing.

- The ☰ indicator means:
 - Slow flashing: The white balance is not set or was not able to be set.
 - Quick flashing: The white balance is being adjusted (after you press ▲).
 - Lit steady: The white balance has been set.
- Do not shake or strike the camera during quick flashing the ☰ indicator.
- If the ☰ indicator keeps flashing even when you press ▲, record in automatic white balance mode.

- When you select the one-push white balance mode, the screen momentarily turns blue.
- When flash mode is set to ⚡ (Forced flash) or ⚡SL (Slow synchro), the white balance is adjusted to the condition with the flash emitting.

Shooting techniques

The subject coloring is affected by the lighting conditions. For example, the entire image appears blue under sunlight in the summer, and white items gain a reddish tint under incandescent light bulbs, etc. The human eye can resolve these problems, but digital still cameras cannot recognize the correct colors without adjustments. Normally, the camera makes these adjustments automatically, but if recorded image colors appear unnatural, we recommend that you adjust the white balance.

Shooting in the dark

Mode dial: $\text{📷}/\text{P}/\text{📷}$

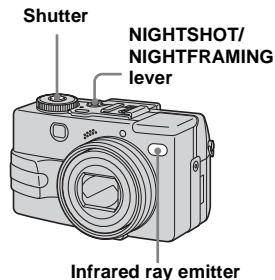

- Filters (not supplied) may block the infrared ray.
- The recommended recording distance for the NightShot or NightFraming function is up to approx. 2.5 m (98 1/2 inches) (W)/2.0 m (78 3/4 inches) (T).

NightShot

The NightShot function lets you shoot subjects in dark places such as camp scenes at night or nocturnal plants and animals.

- 1 Set the mode dial to 📷 , P or 📷 .**
- 2 Set NIGHTSHOT/NIGHTFRAMING lever to NIGHTSHOT.**



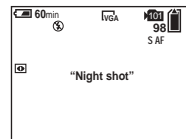

The 📷 and “Night shot” indicators light. The “Night shot” indicator turns off after 5 seconds.



- 3 Shoot the image.**



To cancel the NightShot function

Set NIGHTSHOT/NIGHTFRAMING lever to 📷 .

- While using the NightShot function, you cannot use the following functions:
 - Focus Preset
 - LCD screen off
 - AE LOCK
 - Shooting with hologram AF
 - Shooting with the flash
- While using the NightShot function:
 - The white balance is set to Auto.
 - The metering mode is set to center weighted.
 - If you perform any invalid operation, the  indicator flashes, and the “Night shot” indicator lights for about five seconds. However, if you press  (⚡) in Exposure Bracket, Multi Burst or Burst 3 mode, the BRK// indicator flashes.
- Do not use the NightShot function in bright places (e.g. outdoors in the daytime). This may cause your camera to malfunction.
- Images shot using the NightShot function are recorded with a green tint as if viewing an LCD screen.

NightFraming

The NightFraming function enables you to check a subject even at night and then record with natural colors using the flash.

- 1 Set the mode dial to , P or  (Clip Motion).**
- 2 Set NIGHTSHOT/NIGHTFRAMING lever to NIGHTFRAMING.**

The  and “Night framing” indicators light. The “Night framing” indicator turns off after about 5 seconds.

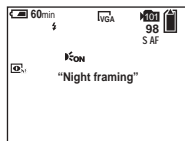

- 3 Press and hold the shutter button halfway down.**



When [Hologram AF] is set to [Off], you may not get a clear focus. Setting [Hologram AF] to [Auto] is recommended.

- 4 Press the shutter button fully down.**

The shutter sounds, the flash strobes and the image is recorded.

To cancel the NightFraming function

Set NIGHTSHOT/NIGHTFRAMING lever to .

- While using the NightFraming function, you cannot use the following functions:
 - LCD screen off
 - AE LOCK
 - Focus Preset
- While using the NightFraming function:
 - The white balance is set to Auto.
 - The metering mode is set to multi-pattern metering.
 - The AF range finder is fixed to the center.
 - If you perform any invalid operation while using the NightFraming function, the  indicator flashes and the “Night framing” indicator lights for about five seconds.
- When you press the shutter button halfway down you will hear a sound, but this is not the sound of the shutter releasing. The image is not recorded yet.
- The flash does not function when recording in Burst 3 and in Exposure Bracket modes. If you press  (⚡) the BRK/ indicator flashes.

Adjusting the flash level

— Flash Level

Mode dial: P/S/A/M/SCN

You can adjust the amount of flash light.

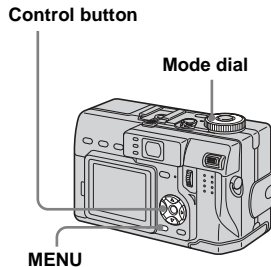

1 Set the mode dial to P, S, A, M or SCN.

2 Press MENU.

The menu appears.

3 Select [\pm] (Flash Level) with \leftarrow/\rightarrow , then select the desired setting with $\blacktriangle/\blacktriangledown$.

High: Makes the flash level higher than normal.

Normal: Normal setting.

Low: Makes the flash level lower than normal.

- You can carry out this operation even when the mode dial is set to  (Clip Motion).

Shooting multiple frames

— Clip Motion

Mode dial: 

You can shoot a number of consecutive still images (GIF animation). The GIF format has a small file size, making it convenient for creating home pages or attaching images to e-mail.

- Due to the limitations of the GIF format, the number of colors for Clip Motion images is reduced to 256 colors or less. Therefore, the image quality may deteriorate for some images.

Normal (160×120)

Clip Motion of up to 10 frames can be recorded. This is suitable for use on home pages, etc.

Mobile (120×108)

Clip Motion of up to two frames can be recorded. This is suitable for use with portable data terminals.

- The file size is reduced in Mobile mode, so the image quality deteriorates.

Before operation

Set [Moving Image] to [Clip Motion] in the SET UP settings (pages 39 and 115).

Control button

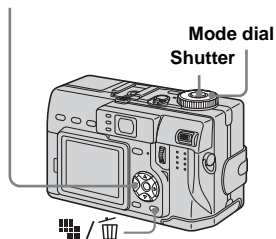

1 Set the mode dial to .

2 Press  /  (Image Size).

The Image Size setup appears.

3 Select the desired mode with  / .

You can select from [Normal] or [Mobile].

4 Shoot the image for the first frame.



5 Shoot the image for the next frame.

Press the shutter button to shoot the next frame, then repeat this operation until you have shot the desired number of frames.





6 Press .



All the frame images are recorded on the "Memory Stick".

To delete some or all of the frame images while making a Clip Motion recording

1 Press  (⊖) in step **4** or **5**.

The frame images you shot are played back in turn and stop at the last image.

2 Press  /  (Delete), and select [Delete Last], or [Delete All] with  / , then press .

3 Select [Delete] with , then press .

When [Delete Last] is selected in step **2**, each time you repeat steps **1** through **3**, the last frame you shot is deleted.

- Note that all images are not recorded on the "Memory Stick" until you carry out step **6**.
- For the number of images that can be recorded in Clip Motion, see page 109.
- The date and time are not superimposed onto Clip Motion images.
- When viewing an image recorded in Clip Motion on the index screen, the image may appear different from the actual image.
- GIF files not created on this camera may not be displayed correctly.

Shooting in Multi Burst mode

— Multi Burst

Mode dial: 

This mode records 16 frames in succession each time you press the shutter button. This is convenient for checking your form in sports, for example.



Before operation

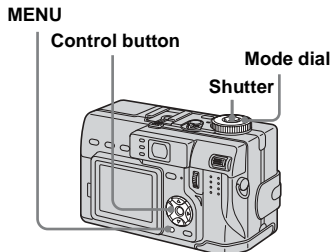

Set [Moving Image] to [Multi Burst] in the SET UP settings (pages 39 and 115).



1 Set the mode dial to .

2 Press MENU.

The menu appears.

3 Select  (Interval) with , then select the desired frame interval with .

You can choose the frame interval from the menu settings (page 39).

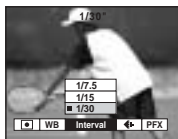

4 Shoot the image.

The 16 frames are recorded as a single image (image size: 1.2M).

- See page 72 to play back images recorded in Multi Burst mode using this camera.
- For the number of images that can be recorded in Multi Burst mode, see page 109.
- You cannot use the flash in this mode.
- Date and time cannot be superimposed onto images.

Shooting three images continuously

— Burst 3

Mode dial: /P/S/A/M/SCN

This mode is used for continuous shooting. Each time you press the shutter button in this mode, the camera records three images in succession.

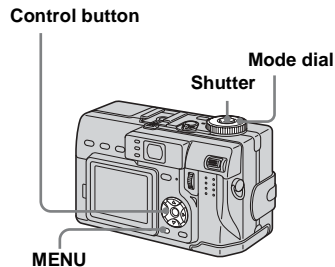

1 Set the mode dial to , P, S, A, M or SCN.

2 Press MENU.

The menu appears.

- 3** Select [Mode] (REC Mode) with **◀/▶**, then select [Burst 3] with **▲/▼**.

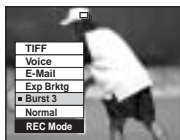

- 4** Shoot the image.

When the “Recording” indication disappears, you can shoot the next image.

To return to normal mode

Select [Normal] in step **3**.

- You cannot use the flash in this mode.
- During shooting in this mode, the images are not displayed on the screen. Compose the image before pressing the shutter button.
- The recording interval is approximately 0.5 second.
- You cannot select certain shutter speeds*.

* When [ISO] is [800]:

Shutter speeds of 1/25 second or slower

When [ISO] is other than [800]:

Shutter speeds of 1/6 second or slower

Shooting still images in TIFF mode

— TIFF

Mode dial: /P/S/A/M/SCN

This mode records an image without compression, so the image quality does not deteriorate. Images recorded in this mode are suitable for editing on a computer, etc.

Control button

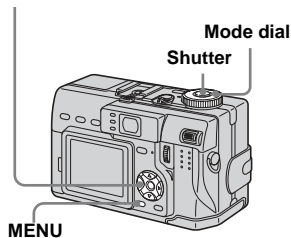

- 1** Set the mode dial to , P, S, A, M or SCN.

- 2** Press MENU.

The menu appears.

- 3** Select [Mode] (REC Mode) with **◀/▶**, then select [TIFF] with **▲**.

- 4** Shoot the image.

When the “Recording” indication disappears, you can shoot the next image.

To return to normal mode

Select [Normal] in step **3**.

- JPEG images are also recorded in the image size selected by the Image Size setup (page 18). Uncompressed (TIFF) images are recorded in [5.0M] size except when [4.5M (3:2)] is selected.
- Writing data takes more time than in normal recording mode.
- For the number of images you can record in TIFF mode, see page 109.

Shooting still images for e-mail

— E-Mail

Mode dial: /P/S/A/M/SCN

In E-mail mode, a small-size image (320×240) that is suitable for e-mail transmission is also recorded at the same time as recording a normal still image. (See page 18 for the normal still image sizes.)

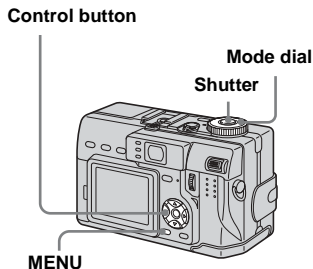

- 1** Set the mode dial to , P, S, A, M or SCN.
- 2** Press MENU.
The menu appears.
- 3** Select [Mode] (REC Mode) with /▶, then select [E-Mail] with ▲/▼.

4 Shoot the image.

When the “Recording” indication disappears, you can shoot the next image.

To return to normal mode

Select [Normal] in step **3**.

- For instructions on how to attach images to an e-mail message, consult the User’s Manual for your e-mail software.
- For the number of images you can record in E-mail mode, see page 109.

Shooting still images with audio files

— Voice

Mode dial: /P/S/A/M/SCN

In Voice mode, an audio track is also recorded at the same time as recording a normal still image.

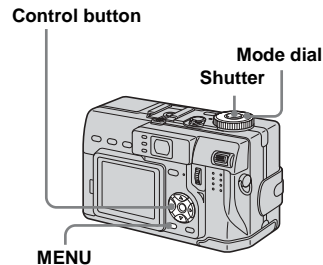

- 1** Set the mode dial to , P, S, A, M or SCN.
- 2** Press MENU.
The menu appears.
- 3** Select [Mode] (REC Mode) with /▶, then select [Voice] with ▲/▼.

4 Shoot the image.

If you press and release the shutter button, sound is recorded for five seconds.

If you hold down the shutter button, sound is recorded until you release the shutter button for up to 40 seconds.

To return to normal mode

Select [Normal] in step 3.

- To view images recorded in Voice mode, carry out the same procedure described in “Viewing movies on the LCD screen” (page 80).
- For the number of images you can record in Voice mode, see page 110.

Shooting according to scene conditions

— Scene Selection

Mode dial: SCN

When shooting night scenes, shooting people at night, shooting landscapes, shooting portraits, shooting snowy scenes, or shooting at the shore, use the following modes to increase the quality of your images.

When the shutter speed is 1/6 second or slower, the NR slow shutter function activates automatically (page 44).

☾ Twilight mode

Allows you to shoot night scenes at far distance without losing the dark atmosphere of the surroundings. The shutter speed becomes slower, so we recommend that you use a tripod to prevent shaking.



- You cannot shoot in macro mode.
- You cannot use the flash.

☾ Twilight portrait mode

Suitable for shooting portraits in dark places. Allows you to shoot sharp images of people in dark places without losing the dark atmosphere of the surroundings. The shutter speed becomes slower, so we recommend that you use a tripod to prevent shaking.





- The flash strobos regardless of the surrounding brightness.

Landscape mode

Focuses on a distant subject to shoot landscapes, etc.



- You cannot shoot in macro mode.
- The flash is set to  (Forced flash) or  (No flash).

Portrait mode



Backgrounds blur away, and the subject is sharpened.



Snow mode

When shooting snowy scenes or other places where the whole screen appears white, use this mode to prevent sunken colors and record clear and sharp images.





- The flash is set to  (Forced flash) or  (No flash).

Beach mode

When shooting seaside or lakeside scenes, the blue of the water is clearly recorded.



- The flash is set to  (Forced flash) or  (No flash).

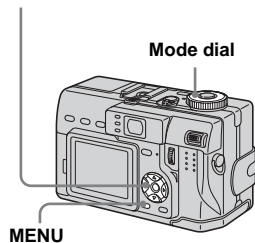

Control button



1 Set the mode dial to SCN.

2 Press MENU.

The menu appears.

3 Select [SCN] with , then select the desired mode with /.

To cancel Scene Selection

Set the mode dial to a different mode.

- When you record in Burst 3 mode or Exposure Bracket mode, the shutter speed becomes faster, so the image may not be recorded just as you intended.
- When the NR slow shutter function activates, shooting may take some time.
- The setting is maintained even when the power is turned off.

Adding special effects

— Picture Effect

Mode dial: P/S/A/M/SCN/

You can digitally process images to obtain special effects.

Solarize



The light contrast is clearer and the picture looks like an illustration.

Sepia



The picture is sepia-toned like an old photograph.

Neg.Art



The color and brightness of the picture are reversed as in a negative.

Control button

Mode dial

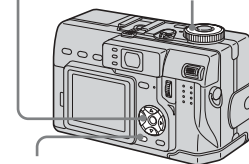

MENU

- 1** Set the mode dial to P, S, A, M, SCN or .
- 2** Press MENU.
The menu appears.
- 3** Select [PFX] (P. Effect) with ◀/▶, then select the desired mode with ▲/▼.

To cancel Picture Effects

Select [Off] in step **3**.

Using an external flash

Mode dial: P/S/A/M/SCN

Using an external flash (not supplied) will allow you to shoot more vivid flash pictures than when using an internal flash. For details, please consult the operating instructions supplied with your flash.

Advanced accessory shoe

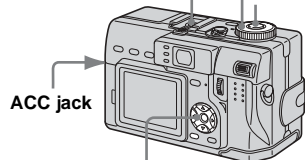

Mode dial

Shutter



ACC jack

Control button

- The flash does not strobe when shooting in Burst 3, Exposure Bracket, Twilight, MPEG Movie or Multi Burst mode.
- You cannot have an external flash and the built-in flash strobe at the same time.
- Note that when shooting with two or more external flashes, the camera functions may not operate normally, or the camera may malfunction.
- You can carry out this operation even when the mode dial is set to  (Clip Motion).
- If the white balance cannot be adjusted when shooting with an external flash, set the flash mode to  (Forced flash) or SL (Slow synchro), and set the one-push white balance mode (page 55).

Using the Sony flash (not supplied)

You can mount the Sony HVL-F32X or HVL-F1000 flash on the advanced accessory shoe of your camera. The HVL-F32X is also equipped with automatic flash level adjustment and AF fill light shooting functions.

1 Mount the external flash on the advanced accessory shoe.

2 Plug the flash into the ACC jack.

When using the HVL-F32X, you do not need to perform step **2**.

3 Turn on the external flash.

4 Set the mode dial to , P, S, A, M or SCN.

5 Shoot the image.





- When using a Sony optional external flash, check that [Hot Shoe] is set to [Off] in the SET UP settings (page 116).

Using a commercially available external flash

You can mount a commercially available external flash that supports advanced accessory shoe.



1 Mount the external flash to the advanced accessory shoe.

2 Set the mode dial to SET UP.

3 Select  (Camera 2) with /▼, [Hot Shoe] with /▲/▼, [On] with /▲, then press .

4 Turn on the external flash.

5 Set the mode dial to M or A.

The flash also strobes when the mode dial is set to , P, S, SCN or  (Clip Motion), but we recommend recording with the mode dial set to M or A.

6 Shoot the image.

- Set the most appropriate aperture value according to the guide number of the flash used and the distance to the subject.
- The flash guide number varies according to the ISO sensitivity (page 111) of the camera, so be sure to check the ISO number.
- Note that the camera may not function properly or may malfunction when using a flash manufactured by another company for a specific camera (generally a flash with multiple contact points on the advanced accessory shoe), a high-voltage type flash, or a flash accessory.
- If you record with [Hot Shoe] set to [Off] in the SET UP settings, the built-in flash may rise up. If this happens, return the built-in flash to its original position and set [Hot Shoe] to [On] (page 116).
- Depending on the type of commercially available external flash, you may be unable to use some functions, and other operations may be difficult.

Using a conversion lens

Mode dial: 

Using a conversion lens (not supplied) will allow you to shoot with enhanced wide or telephoto effects. For details, please consult the operating instructions supplied with your conversion lens.

- **Always turn off the camera before mounting or removing the conversion lens. Failure to do so may result in damage or other malfunction.**
- When using the built-in flash, the light from the built-in flash may be blocked, causing the lens shadow to appear. We recommend using the Sony optional external flash.

Notes on using the Sony VCL-DEH07V wide end conversion lens

- You cannot shoot with the NightShot or NightFraming functions.
- The camera automatically switches to the macro recording mode. However,  is not displayed.
- The zoom feature cannot be used.
- The built-in hologram AF cannot be used. We recommend using the Sony HVL-F32X flash.

Notes on using the Sony VCL-DEH17V telephoto end conversion lens

- Set the zoom lever to the T (telephoto) side. Moving the zoom lever to the W (wide) side may cause the lens shadow to appear or make it difficult to focus.
- When shooting with the NightShot function, the infrared rays may be blocked by the lens. We recommend using the Sony HVL-IRM infrared light.
- When shooting with the NightFraming function, use both the Sony HVL-F32X flash and the Sony HVL-IRM infrared light. However, note that the image may gain a reddish tint.

Selecting the folder and playing back images

— Folder

Mode dial:

Select the folder that images you want to playback are stored.

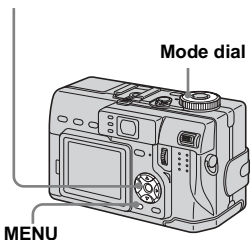

Control button



1 Set the mode dial to .

2 Press MENU.

The menu appears.

3 Select [Folder] with , then press .

4 Select the desired folder with

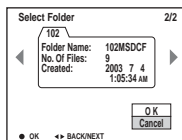

5 Select [OK] with , then press





To cancel the selection

In step **5**, select [Cancel].

When multiple folders are created in the “Memory Stick”

When the first or last image in the folder is displayed, the following indicators appear on the screen.

: Moves to the previous folder.

: Moves to the next folder.

: Moves to both the previous and next folders.

Single screen



Index (nine-image) screen

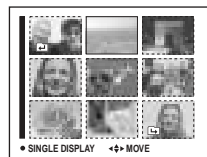

Index (triple-image) screen

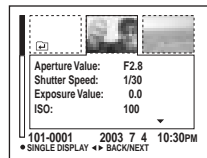

- When no images are stored in the folder, “No file in this folder” appears.
- You can playback images from a last-shot one without selecting the folder.

Enlarging a portion of a still image



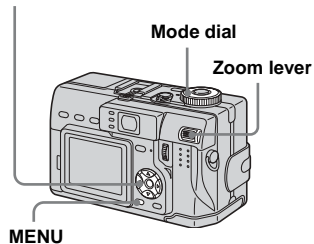

Mode dial: 

You can enlarge a part of an image up to five times the original size. You can also record the magnified image as a new file.

Control button



Enlarging an image — Playback zoom

- 1** Set the mode dial to .
- 2** Display the image to be enlarged.
- 3** Press the zoom lever to the T (telephoto) side to zoom in on the image.
- 4** Select the desired portion of the image with .



- ▲: To view more of the top of the image
- ▼: To view more of the bottom of the image
- ◀: To view more of the left side of the image
- ▶: To view more of the right side of the image

- 5** Adjust the image size with the zoom lever.



To cancel playback zoom

Press .

- You cannot use playback zoom for movies (MPEG Movie), Clip Motion images and Multi Burst images.
- You can enlarge the images displayed with the Quick Review function (page 22) by performing steps **3** to **5**.

Recording an enlarged image — *Trimming*

- 1 Press MENU after playback zoom.**

The menu appears.

- 2 Select [Trimming] with \blacktriangleright , then press \bullet .**

- 3 Select the image size with $\blacktriangle/\blacktriangledown$, then press \bullet .**

The image is recorded, and the image on the screen returns to the normal size after recording.

- The trimmed image is recorded as the newest file in the selected recording folder, and the original image is retained.
- The quality of trimmed images may deteriorate.
- You cannot trim to an image size of 3:2.
- You cannot trim uncompressed (TIFF) images.
- You cannot trim images displayed with Quick Review.

Playing back successive images

— Slide Show

Mode dial: \blacktriangleright

You can play back recorded images in order. This function is useful for checking your images or for presentations, etc.

Control button

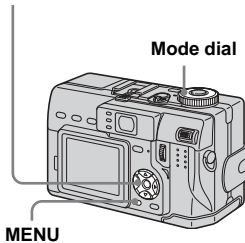

- 1 Set the mode dial to \blacktriangleright .**

- 2 Press MENU.**

The menu appears.

- 3 Select [Slide] with $\blacktriangleleft/\blacktriangleright$, then press \bullet .**

Set the following items with $\blacktriangle/\blacktriangledown/\blacktriangleleft/\blacktriangleright$.

Interval

3 sec/ 5 sec/10 sec/30 sec/1 min

Image

Folder: Plays back all images in the selected folder.

All: Plays back all images stored in the “Memory Stick”.

Repeat

On: Plays back images in a continuous loop.

Off: After all the images have been played back, the slide show ends.

- 4 Select [Start] with $\blacktriangledown/\blacktriangleright$, then press \bullet .**

The slide show begins.

To cancel the Slide Show setting

Select [Cancel] in step **3**.

To stop slide show playback

Press ●, select [Exit] with ►, then press ● again.

To skip to the next/previous image during the slide show

Press ► (next) or ◀ (previous).

- The interval setting time is approximate, and may vary according to the playback image size.

Rotating still images

— Rotate

Mode dial: ►

You can rotate an image recorded in portrait orientation and display it in landscape orientation.



Control button

Mode dial

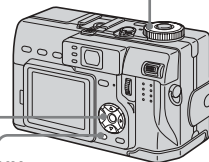

MENU

- 1** Set the mode dial to ►, and display the image to rotate.
- 2** Press MENU.
The menu appears.
- 3** Select [Rotate] with ◀/►, then press ●.
- 4** Select ↶ ↷ with ▲, then rotate the image with ◀/►.
- 5** Select [OK] with ▲/▼, then press ●.



To cancel rotation

Select [Cancel] in step **4** or **5**, then press ●.

- You cannot rotate protected images and images recorded as movies (MPEG Movie), Clip Motion, Multi Burst and uncompressed (TIFF) images.
- You may not be able to rotate images shot with other cameras.
- When viewing images on a computer, the image rotation information may not be reflected depending on the application software.

Playing back images shot in Multi Burst mode

Mode dial: ▶

You can play back Multi Burst images continuously or play them back frame by frame. This function is used for checking the image.

Control button

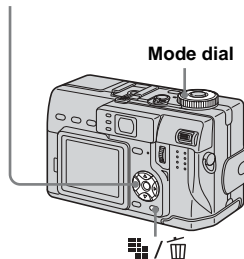

- When Multi Burst images are played back on a computer or on a camera without the Multi Burst function, the 16 frames you shot will be displayed at the same time as part of one image.

Playing back continuously

1 Set the mode dial to ▶.

2 Select the Multi Burst image with ◀▶.

The selected Multi Burst image is played back continuously.



To pause playback

Press ●. To resume playback, press ● again. The playback starts from the frame displayed on the LCD screen.

Playing back frame by frame

— Jog playback

1 Set the mode dial to .

2 Select the Multi Burst image with / .



The selected Multi Burst image is played back continuously.



3 Press  when the desired frame is displayed.

“Step” appears.



4 Advance the frame with / .

: A next frame is displayed. When you keep and press , the frame advances.



: A previous frame is displayed. When you keep and press , the frame advances in the reverse direction.

To return to the normal playback

Press  in step **4**. The playback starts from the frame displayed on the LCD screen.

To delete shot images

When using this mode, you cannot delete only certain frames. When you delete images, all 16 of the frames are deleted at the same time.

- 1 Display the desired Multi Burst image to delete.
- 2 Press  /  (Delete).
- 3 Select [Delete], then press . All of the frames are deleted.

Protecting images

— Protect

Mode dial: 





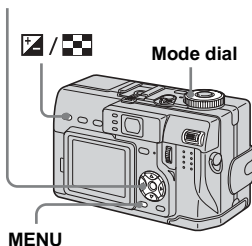

This function protects images against accidental erasure.

Control button



- It may take some time to protect the images.



In single-image mode

- 1** Set the mode dial to .
- 2** Display the image you want to protect with / .
- 3** Press MENU.
- 4** Select [Protect] with / , then press .



The menu appears.

The displayed image is protected. The  (protect) indicator appears on the image.

















- 5** To continue and protect other images, select the desired image with / , then press .

To cancel the protection

Press  again in step **4** or **5**. The  indicator disappears.

In index (nine-image) mode

- 1** Set the mode dial to , then press  (index) to display the index (nine-image) screen.
- 2** Press MENU.
- 3** Select [Protect] with / , then press .
- 4** Select [Select] with / , then press .
- 5** Select the image you want to protect with / / / , then press .

The green  indicator appears on the selected image.

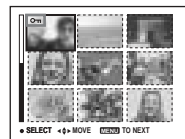

- 6** Repeat step **5** to protect other images.

7 Press MENU.**8 Select [OK] with \blacktriangleright , then press \bullet .**

The On indicator turns white. The selected images are protected.

To exit the Protect function

Select [Cancel] in step **4** or select [Exit] in step **8**, then press \bullet .

To cancel individual protection

Select the image to be unprotected with $\blacktriangle/\blacktriangledown/\blacktriangleleft/\blacktriangleright$, then press \bullet in step **5**. The On indicator turns gray. Repeat this operation for all images that are to be unprotected. Press MENU, select [OK], and then press \bullet .

To protect all images in the folder

Select [All In Folder] in step **4**, and press \bullet . Select [On], then press \bullet .

To cancel all protection of all images in the folder

Select [All In Folder] in step **4**, and press \bullet . Select [Off], then press \bullet .

In index (triple-image) mode

1 Set the mode dial to index , then press index (index) twice to display the index (triple-image) screen.**2 Display the image you want to protect in the center position with $\blacktriangleleft/\blacktriangleright$.****3 Press MENU.**

The menu appears.

4 Select [Protect] with $\blacktriangle/\blacktriangledown$, then press \bullet .

The center image is protected. The On indicator appears on the image.

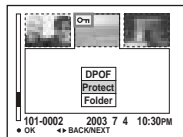
**5 To protect other images, display the image you want to protect in the center position with $\blacktriangleleft/\blacktriangleright$, and repeat step **4**.****To cancel previously set protection**

Select the image to be unprotected, and press \bullet in step **4**. To cancel protection of all images, repeat this process for each image.

Changing image size

— Resize

Mode dial: 

You can change the image size of a recorded image, and save it as a new file. You can resize to the following sizes. 5.0M, 3.1M, 1.2M, VGA
The original image is retained even after resizing.

Control button

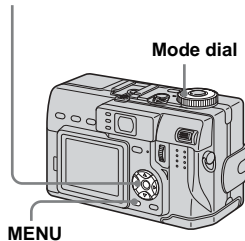

1 Set the mode dial to .

2 Display the image you want to resize with  .

3 Press MENU.

The menu appears.

4 Select [Resize] with  , then press .

5 Select the desired size with  , then press .

The resized image is recorded in the recording folder as the newest file.

To cancel resizing

Select [Cancel] in step **5**.

- You cannot change the size of movies (MPEG Movie), Clip Motion, Multi Burst or uncompressed (TIFF) images.
- When you change from a small size to a large size, the image quality deteriorates.
- You cannot resize to an image size of 3:2.
- When you resize a 3:2 image, the upper and lower black portions will be displayed on the image.

Choosing images to print

— Print (DPOF) mark

Mode dial: 

You can mark still images shot with your camera that you want to have printed. This function is convenient when you have images printed at a shop or using a printer that conforms with the DPOF (Digital Print Order Format) standard.



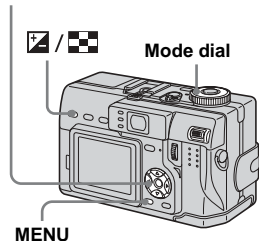

Control button



- You cannot mark movies (MPEG Movie) or Clip Motion images.
- In E-mail mode, a print (DPOF) mark is marked on the normal size image that is recorded at the same time.
- When you mark images shot in Multi Burst mode, all the images are printed on one image divided into 16 frames.



- If you mark an image shot in TIFF mode with a print (DPOF) mark, only the uncompressed (TIFF) image is printed, and the JPEG image recorded at the same time is not printed.

In single-image mode



- 1** Set the mode dial to .
- 2** Display the image you want to mark with / .
- 3** Press MENU.
The menu appears.
- 4** Select [DPOF] with / , then press .

The  mark is marked on the displayed image.













- 5** To continue and mark other images, display the desired image with / , then press .

To unmark the mark

Press  again in step **4** or **5**. The  mark disappears.

In index (nine-image) mode

- 1** Set the mode dial to , then press /  (index) to display the index (nine-image) screen.
- 2** Press MENU.
The menu appears.
- 3** Select [DPOF] with , then press .
- 4** Select [Select] with , then press .
- 5** Select the image you want to mark with / / , then press .

- When marking  marks, you cannot select [All In Folder].

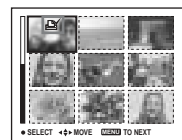

The green  mark appears on the selected image.



- 6** Repeat step **5** to mark other images.

7 Press MENU.

8 Select [OK] with **▶**, then press **●**.

The  mark turns white. The  mark setting is completed.

To unmark marks

Select the images to be unmarked in step **5**, then press **●**.



To unmark all the marks in the folder

Select [All In Folder] in step **4**, then press **●**. Select [Off], then press **●**.

To exit the mark function

Select [Cancel] in step **4**, or select [Exit] in step **8**.

In index (triple-image) mode

1 Set the mode dial to , then press  (index) twice to display the index (triple-image) screen.

2 Display the image you want to mark in the center position with **◀▶**.

3 Press MENU.

The menu appears.

4 Select [DPOF] with **▲**, then press **●**.

The  mark is marked on the center image.

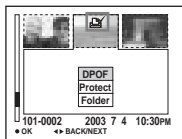

5 To continue and mark other images, display the image you want to print in the center position with **◀▶**, and repeat step **4**.

To unmark the mark

Press **●** again in step **4**. The  mark disappears. Repeat this operation for all the images you want to unmark.

Shooting movies

Mode dial:

You can shoot movies with sound (MPEG movies) using your camera.

Before starting

Set [Moving Image] to [MPEG Movie] in the SET UP settings (pages 39 and 115).

Control button

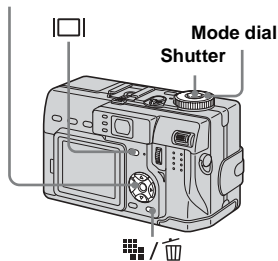

1 Set the mode dial to .

2 Press  /  (Image Size).

The Image Size setup appears.

3 Select the desired size with  / .

You can choose from 640 (VGA), 160 (Mail).

For details on the recording time for each image size, see page 109.

4 Press the shutter button fully down.

“REC” appears on the screen and the camera starts recording the image and sound.



• Recording stops when the “Memory Stick” is full.

5 Press the shutter button fully down again to stop recording.

Indicators during shooting

The screen indicators are not recorded. Each time you press , the status of the LCD screen changes as follows: Indicators off → LCD screen off → Indicators on. A histogram is not displayed. For a detailed description of the indicators, see page 125.

Shooting close-ups (Macro)

Set the mode dial to  and follow the procedure on page 24.

Using the self-timer

Set the mode dial to  and follow the procedure on page 25.

- Do not touch the microphone (page 8) during shooting movies.
- You cannot use the flash.
- The date and time are not superimposed onto movies.
- The zoom magnification cannot be changed while shooting movies.

Viewing movies on the LCD screen

Mode dial:

You can view movies on the LCD screen with sound from the speaker.

Control button

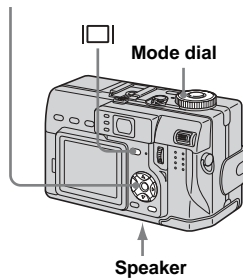

1 Set the mode dial to .

2 Select the desired movie with .

Movies with the image size [160 (Mail)] are displayed a size smaller.

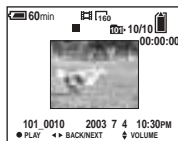

- Movies with the image size [640 (VGA)] are displayed on the full screen.

3 Press .

The movie and sound are played back. During playback,  (Playback) appears on the screen.

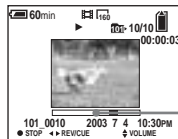



Playback bar



To stop playback

Press  again.

To adjust the volume

Press   to adjust the volume.

To advance or rewind the movie

Press   during playback.

To return to the normal playback, press .

Indicators during viewing movies

Each time you press , the status of the screen changes as follows: Indicators off → LCD screen off → Indicators on.

A histogram is not displayed.

For a detailed description of the indicators, see page 127.

- The procedure for viewing movies on a TV is the same as that for viewing still images (page 32).
- The movies recorded using earlier Sony models may be also displayed a size smaller.

Deleting movies

— Delete

Mode dial:

You can delete unwanted movies.

Control button

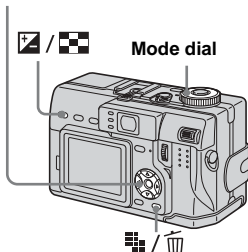

In single-image mode

- 1** Set the mode dial to .
- 2** Display the movie you want to delete with .
- 3** Press / (Delete).
The movie has not yet been deleted at this point.
- 4** Select [Delete] with , then press .
- When the message “Memory Stick access” disappears, the movie has been deleted.
- 5** To continue and delete other movies, display the movie you want to delete with , and repeat step **4**.

To cancel deletion

Select [Exit] in step **4** or **5**.

In index (nine-image) mode

- 1** Set the mode dial to , then press (index) to display an index (nine-image) screen.
- 2** Press / (Delete).
- 3** Select [Select] with , then press .
- 4** Select the movie you want to delete with , then press .

The green (Delete) indicator appears on the selected movie.

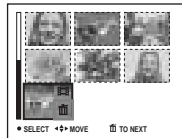

The movie has not yet been deleted at this point.

- 5** Repeat step **4** to delete other movies.
- 6** Press / (Delete).

7 Select [OK] with **▶**, then press



When the message “Memory Stick access” disappears, the movies have been deleted.

To cancel deletion

Select [Exit] in step **3** or **7**.

To delete all movies in the folder

Select [All In Folder] in step **3**, then press

●. Select [OK] with **▶**, then press ●. To cancel deletion, select [Cancel] with **◀**, then press ●.

In index (triple-image) mode

1 Set the mode dial to **▶**, then press **☒/☒** (index) twice to display an index (triple-image) screen.

2 Display the movie you want to delete in the center position with **◀/▶**.

3 Press **☐/☐** (Delete).

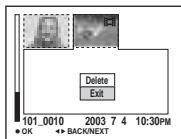

The movie has not yet been deleted at this point.

4 Select [Delete] with **▲**, then press ●.

When the message “Memory Stick access” disappears, the middle-positioned movie has been deleted.

To cancel deletion

Select [Exit] in step **4**, then press ●.

Editing movies

Mode dial:

You can cut movies, or delete unnecessary portions of movies. This is the recommended mode to use when the “Memory Stick” capacity is insufficient, or when you attach movies to your e-mail messages.

The file numbers assigned when movies are cut

The cut movies are assigned new numbers and recorded as the newest files in the selected recording folder. The original movie is deleted, and that number is skipped.

Control button

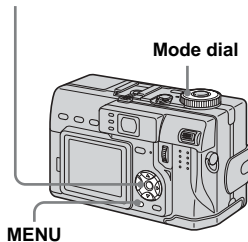

<Example> Cutting a movie numbered 101_0002

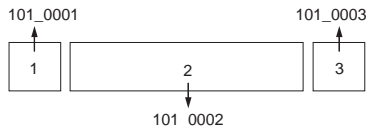

1. Cutting scene A.

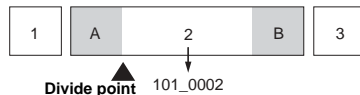

2. Cutting scene B.

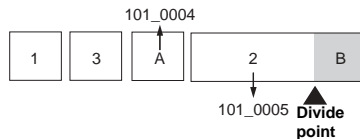



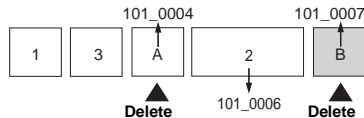



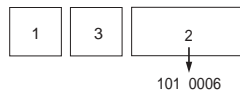

3. Deleting scenes A and B if they are unnecessary.







4. Only the desired scenes remain.



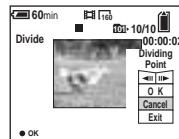

Cutting movies

- 1 Set the mode dial to .
- 2 Select the movie you want to cut using / .
- 3 Press MENU. The menu appears.
- 4 Select [Divide] with , then press . Next, select [OK] with , then press .
- 5 Decide on a cutting point. The playback of the movie starts. Press the center  at the desired cutting point.



When you want to adjust the cutting point, use [/ ] (frame forward/rewind) and adjust the cutting point using / . If you want to change the cutting point, select [Cancel]. The playback of the movie starts again.

- 6 When you have decided on a cutting point, select [OK] with , and press .

7 Select [OK] with ▲, then press ●.

The movie is cut.

To cancel cutting

Select [Exit] in step **5** or **7**. The movie appears on the screen again.

- You cannot cut the following images.
 - Clip Motion
 - Multi Burst
 - Still image
 - MPEG movie files not long enough to cut
 - Protected MPEG movie files
- You cannot restore files once you cut them.
- The original movie is deleted when you cut it.
- The cut movies are recorded as the newest files in the selected recording folder.

Deleting unnecessary portions of movies

1 Cut an unnecessary portion of a movie (page 83).

2 Display the portion of the movie you want to delete.

3 Press  /  (Delete).

The movie has not yet been deleted at this point.

4 Select [Delete] with ▲, then press ●.

The movie currently displayed on the screen is deleted.

Copying images to your computer — For Windows users

Recommended computer environment

OS: Microsoft Windows 98, Windows 98SE, Windows 2000 Professional, Windows Millennium Edition, Windows XP Home Edition, or Windows XP Professional

The above OS must be installed at the factory. Operation is not assured in an environment upgraded to the operating systems described above or in a multi-boot environment.

CPU: MMX Pentium 200 MHz or faster

USB connector: Provided as standard

Display: 800 × 600 dots or more

High Color (16-bit color, 65,000 colors) or more

- Use with a USB 2.0 (High-Speed USB) compatible computer environment allows high-speed data transfer.
- If you connect two or more USB equipment to a single computer at the same time, some equipment, including your camera, may not operate depending on the type of USB equipment.
- Operations are not guaranteed when using a USB hub.

- Operations are not guaranteed for all the recommended computer environments mentioned above.

USB mode

There are two modes for a USB connection, [Normal] and [PTP]* modes. The factory setting is the [Normal] mode.

* Compatible only with Windows XP. When connected to a computer, only the data in the folder selected by the camera is copied to the computer. To select a folder, perform the procedure from step 2 on page 68.

Communication with your computer

When your computer resumes from the suspend or sleep mode, communication between your camera and your computer may not recover at the same time.

When a USB connector is not provided on your computer

When neither a USB connector nor a “Memory Stick” slot is provided, you can copy images using an additional device. See the Sony Website for details.
<http://www.sony.net/>

Contents of the CD-ROM

■ USB Driver

This driver is needed in order to connect the camera to a computer.

- When using Windows XP, you need not install the USB driver.

■ Image Transfer

This application is used to easily transfer images from the camera to a computer.

■ ImageMixer

This application is used to display and edit images that are stored in a computer.

- This section describes the Windows Me screen as an example. The required operations may differ depending on your OS.
- **Close down all applications running on the computer before installing the USB driver and application.**
- When using Windows XP or Windows 2000, log on as Administrators.
- The display settings should be 800 × 600 dots or more and High Color (16-bit color, 65,000 colors) or more. When set to less than 800 × 600 dots or 256 colors or less, the model selection screen does not appear.



Installing the USB driver

When using Windows XP, you need not install the USB driver.

Once the USB driver is installed, you need not install the USB driver again.

- 1 Start up your computer, and insert the supplied CD-ROM into the CD-ROM drive.**

Do not connect your camera to your computer at this time.

The model selection screen appears. If it does not appear, double-click  (My Computer) →  (ImageMixer) in that order.

- 2 Click [Cyber-shot] on the model selection screen.**

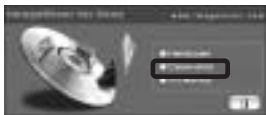

The installing menu screen appears.

- 3 Click [USB Driver] on the installing menu screen.**

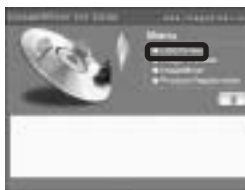

The "InstallShield Wizard" screen appears.

- 4 Click [Next]. When the "Information" screen appears, click [Next].**

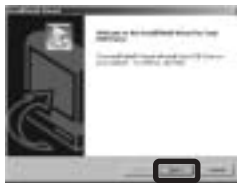

The USB driver installation starts. When the installation is completed, the screen informs you of completion.

- 5 Click [Yes, I want to restart my computer now], then click [Finish].**



Your computer restarts. Then, you can establish USB connection.

Installing “Image Transfer”

You can use the “Image Transfer” software to copy images to your computer automatically when you connect the camera to your computer with the supplied USB cable.

- 1** Click [Cyber-shot] on the model selection screen.

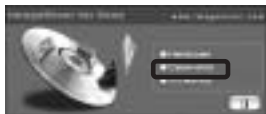

The installing menu screen appears.

- 2** Click [Image Transfer] on the installing menu screen. Select the desired language, then click [OK].



The “Welcome to the InstallShield Wizard” screen appears.

- This section describes the English screen.

- 3** Click [Next]. When “Licence Agreement” screen appears, click [Yes].



Read the agreement carefully. If you accept the terms of the agreement, proceed with the installation. The “Information” screen appears.

- 4** Click [Next].



- 5** Select the folder to be installed, then click [Next]. Select the program folder, then click [Next].



- 6** Confirm if the checkbox is checked on the “Image Transfer Settings” screen, then click [Next].

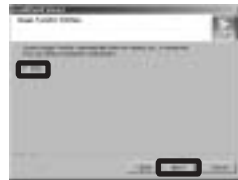

When the installation is completed, the screen informs you of completion.

7 Click [Finish].



The “InstallShield Wizard” screen closes. If you wish to continue with the installation of “ImageMixer,” click [ImageMixer] on the installing menu screen and then follow the procedure.

- The USB driver is needed in order to use “Image Transfer”. If the necessary driver is not already installed on your computer, a screen that asks if you want to install the driver will appear. Follow the instructions that appear on the screen.

Installing “ImageMixer”

You can use the “ImageMixer Ver. 1.5 for Sony” software to copy, view and edit images, and create video CDs. For details, see the software’s help files.

- 1 Click [ImageMixer] on the installing menu screen. Select the desired language, then click [OK].**



The “Welcome to the InstallShield Wizard” screen appears.

- This section describes the English screen.

- 2 Follow instructions on each succeeding screen.**

Install “ImageMixer” according to the screen.

- When you use Windows 2000 or Windows XP, install “WinASPI”.
- If DirectX8.0a or a later version is not installed in your computer, the “Information” screen appears. Follow the procedure on the screen.

- 3 Restart your computer according to the screen.**

- 4 Remove the CD-ROM.**

Connecting the camera to your computer

- 1** Insert the “Memory Stick” with the images you want to copy into the camera. Connect the supplied AC Adaptor, and plug the adaptor into a wall outlet (wall socket).

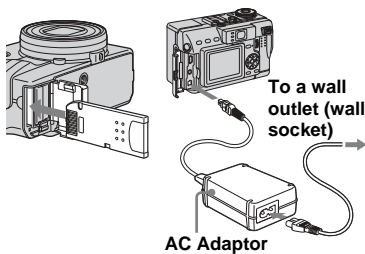

- When you copy images to your computer using the battery pack, copying may be failed or cause data corruption by battery shutoff. We recommend that you use the AC Adaptor.
- For further details on the AC Adaptor, see page 13.
- For further details on the “Memory Stick,” see page 17.

- 2** Turn on your computer and the camera.

- 3** Open the jack cover, and connect the supplied USB cable to the Ψ (USB) jack of the camera.

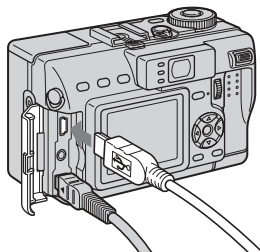

- 4** Connect the USB cable to your computer.

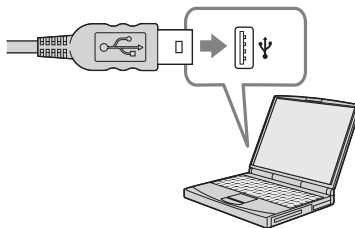

- When you use a desktop computer, we recommend that you connect the USB cable to the USB connector on the rear panel.

- When using Windows XP, the AutoPlay wizard automatically appears on the desktop. Proceed to page 92.

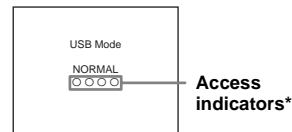



“USB Mode NORMAL” appears on the LCD screen of the camera. When a USB connection is established for the first time, your computer automatically runs the used program to recognize the camera. Wait for a while.

* During communication, the access indicators turn red.

- If “USB Mode NORMAL” does not appear in step **4**, confirm that [USB Connect] is set to [Normal] in the SET UP settings (page 117).

❑ Disconnecting the USB cable from your computer, removing the “Memory Stick” from your camera or turning off the power during USB connection

For Windows 2000, Me, or XP users

- 1 Double-click  on the tasktray.
- 2 Click  (Sony DSC), then click [Stop].
- 3 Confirm the device on the confirmation screen, then click [OK].
- 4 Click [OK].
Step 4 is unnecessary for Windows XP users.
- 5 Disconnect the USB cable, remove the “Memory Stick” or turn off the power.

For Windows 98 or 98SE users

Confirm that the access indicators (page 89) on the LCD screen are turned white and carry out only Step 5 above.

Copying images using “Image Transfer”

— Windows 98/98SE/2000/Me

Connect the camera and your computer with the USB cable.

“Image Transfer” launches and the images are automatically copied to the computer. When copying is complete, “ImageMixer” automatically launches and images appear.



- Normally “Image Transfer” and “Date” folders are created inside the “My Documents” folder, and all of the image files recorded with the camera are copied into these folders.
- You can change the “Image Transfer” settings (page 91).

— Windows XP

Connect the camera and your computer with the USB cable.

“Image Transfer” starts up automatically and the images are automatically copied to the computer.

Windows XP is set so that the OS AutoPlay Wizard activates.

If you want to cancel the setting, follow the procedure below.

1 Click [Start], then click [My Computer].

2 Right-click [Sony MemoryStick], then click [Properties].

3 Cancel the setting.

- ① Click [AutoPlay].
- ② Set [Content type] to [Pictures].
- ③ Check [Select an action to perform] under [Actions], select [Take no action], then click [Apply].
- ④ Set [Content type] to [Video files] and proceed step ③. Set [Content type] to [Mixed content] and proceed step ③.
- ⑤ Click [OK].

The [Properties] screen closes.

The OS AutoPlay Wizard does not start up automatically even if the USB connection is made next time.

Changing “Image Transfer” settings

You can change “Image Transfer” settings. Right-click the “Image Transfer” icon on the tasktray, select [Open Settings]. The settings you can set are as follows: [Basic], [Copy], and [Delete].



When the “Image Transfer” starts, the below window appears.



When you select [Settings] from the above window, you can only change the [Basic] setting.

Copying images without using “Image Transfer”

— Windows 98/98SE/2000/Me

If you do not set to launch “Image Transfer” automatically, you can copy images as following procedure.

1 Double-click [My Computer], then double-click [Removable Disk].

The contents of the “Memory Stick” inserted in your camera appear.

- This section describes an example of copying images to the “My Documents” folder.
- When the “Removable Disk” icon is not shown, see the following column.
- When using Windows XP, see page 92.

2 Double-click [DCIM], then double-click the folder which contains the desired images.





The folder opens.

3 Drag and drop the image files into the “My Documents” folder.

The image files are copied to the “My Documents” folder.

- When you try to copy an image to a folder in which an image with the same file name is stored, the overwrite confirmation message appears. When you want to overwrite the existing image with the new one, the original one is deleted.

When a removable disk icon is not shown

- 1 Right-click [My Computer], then click [Properties].
The “System Properties” screen appears.
 - When using Windows 2000, click [Hardware] on “System Properties” screen.
- 2 Confirm if other devices are already installed.
 - ① Click [Device Manager].
 - ② Confirm if there is a “ Sony DSC” with a  mark under [ Other Devices].
- 3 If you find either of the devices above, follow the steps below to delete them.
 - ① Click [ Sony DSC].
(When using Windows 2000, right-click [ Sony DSC].)
 - ② Click [Remove] (or [Uninstall] in Windows 2000).
The “Confirm Device Removal” screen appears.
 - ③ Click [OK].
The device is deleted.

Try the USB driver installation again using the supplied CD-ROM (page 86).

— Windows XP

Copying images using the Windows XP AutoPlay Wizard

- 1 Make a USB connection (page 89). Click [Copy pictures to a folder on my computer using Microsoft Scanner and Camera Wizard], then click [OK].**

The “Scanner and Camera Wizard” screen appears.

- 2 Click [Next].**

The images stored on the “Memory Stick” are displayed.

- 3 Click the checkbox of images that you do not want to copy to your computer and remove the checkmark, then click [Next].**

The “Picture Name and Destination” screen appears.

- 4 Select a name and destination for your pictures, then click [Next].**

Image copying starts. When the copying is completed, the “Other Options” screen appears.

- 5 Select [Nothing. I’m finished working with these pictures], then click [Next].**

The “Completing the Scanner and Camera Wizard” screen appears.

- 6 Click [Finish].**

The wizard closes.

- To continue copying other images, follow the procedure given under **1** on page 90 to disconnect the USB cable and reconnect it. Then, perform the procedure from step **1** again.

Viewing images on your computer

- 1 Double-click [My Documents] on the desktop.**

The “My Documents” folder contents are displayed.

- This section describes the procedure for viewing copied images in the “My Documents” folder.
- When using Windows XP, click [Start] → [My Documents] in that order.
- You can use the “ImageMixer Ver. 1.5 for Sony” software to view and edit images on your computer. For details, see the software’s help files.

- 2 Double-click the desired folder and image file.**

The image is displayed.

Image file storage destinations and file names

Image files recorded with your camera are grouped as folders in the “Memory Stick”.

Example: For Windows Me users

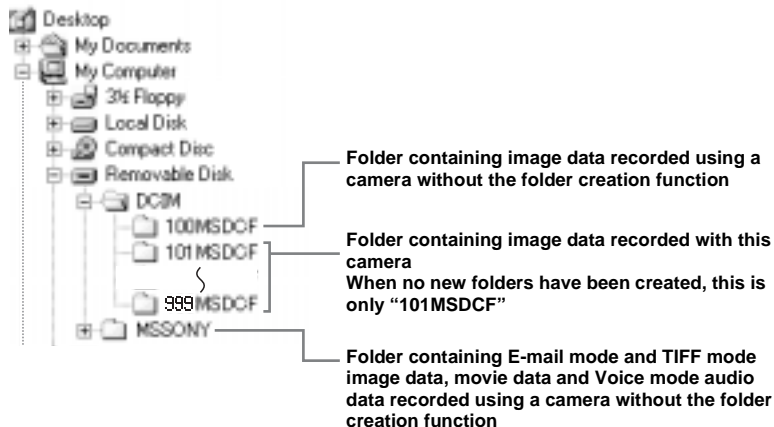

- Data in the “100MSDCF” or “MSONY” folders is for playback only, and your camera cannot record images in these folders.
- For more information about the folder, see page 41.

Folder	File name	File meaning
101MSDCF up to 999MSDCF	DSC0□□□□.JPG	<ul style="list-style-type: none"> • Still image files shot in <ul style="list-style-type: none"> – Normal mode – Exposure Bracket mode (page 53) – Burst 3 mode (page 60) • Image files shot in Multi Burst mode (page 60) • Still image files recorded simultaneously in <ul style="list-style-type: none"> – E-Mail mode (page 62) – TIFF mode (page 61) – Voice mode (page 62)
	DSC0□□□□.JPE	• Small-size image files shot in E-Mail mode (page 62)
	DSC0□□□□.MPG	• Audio files shot in Voice mode (page 62)
	DSC0□□□□.TIFF	• Uncompressed (TIFF) image file recorded in TIFF mode (page 61)
	CLP0□□□□.GIF	• Clip Motion files shot in Normal mode (page 58)
	CLP0□□□□.THM	• Index image files of Clip Motion files shot in Normal mode
	MBL0□□□□.GIF	• Clip Motion files shot in Mobile mode (page 58)
	MBL0□□□□.THM	• Index image files of Clip Motion files shot in Mobile mode
MOV0□□□□.MPG	• Movie files shot in MPEG Movie mode (page 79)	

- □□□□ stands for any number within the range from 0001 to 9999.
- The numerical portions of the following files are the same.
 - A small-size image file shot in E-Mail mode and its corresponding image file
 - An audio file shot in Voice mode and its corresponding image file
 - An uncompressed image file shot in TIFF mode and its corresponding image file
 - An image file shot with Clip Motion and its corresponding index image file

Copying images to your computer

— For Macintosh users

Recommended computer environment

OS: Mac OS 8.5.1, 8.6, 9.0, 9.1, 9.2, or Mac OS X (v10.0/v10.1/v10.2)

The above OS must be installed at the factory. For the following models, update your OS to Mac OS 9.0, 9.1 or 9.2.

- iMac with Mac OS 8.6 installed at the factory, and a slot loading type CD-ROM drive
- iBook or Power Mac G4 with the Mac OS 8.6 installed at the factory

USB connector: Provided as standard

Display: 800 × 600 dots or more
32,000-color mode or more

- If you connect two or more USB equipment to a single computer at the same time, some equipment, including your camera, may not operate depending on the type of USB equipment.
- Operations are not guaranteed when using a USB hub.
- Operations are not guaranteed for all the recommended computer environments mentioned above.

USB mode

There are two modes for a USB connection, [Normal] and [PTP]* modes. The factory setting is the [Normal] mode.

* Compatible only with Mac OS X. When connected to a computer, only the data in the folder selected by the camera is copied to the computer. To select a folder, perform the procedure from step 2 on page 68.

Communication with your computer

When your computer resumes from the suspend or sleep mode, communication between your camera and your computer may not recover at the same time.

When a USB connector is not provided on your computer

When neither a USB connector nor a “Memory Stick” slot is provided, you can copy images using an additional device. See the Sony Website for details.
<http://www.sony.net/>

Steps requires your OS

Follow the steps below, according to your OS.

OS	Steps
Mac OS 8.5.1/8.6/9.0	Steps 1 to 4
Mac OS 9.1/9.2/Mac OS X (v10.0/v10.1/v10.2)	Steps 2 to 4

1 Installing the USB driver

- 1 Turn on your computer, and set the supplied CD-ROM into the CD-ROM drive.
The model selection screen appears.
- 2 Click [Cyber-shot] on the model selection screen.
The installing menu appears.
- 3 Click [USB Driver].
The “USB Driver” screen appears.
- 4 Double-click the icon of the hard disk containing the OS to open the screen.
- 5 Drag and drop the following two files from the screen opened in step 3 into the System Folder icon in the screen opened in step 4.
 - Sony USB Driver
 - Sony USB Shim
- 6 When the message for confirmation is shown, click [OK].
- 7 Restart your computer, then remove the CD-ROM.

2 Connecting your camera to your computer

For details, see page 89.

Disconnecting the USB cable from your computer, removing the “Memory Stick” from your camera or turning off the power during a USB connection

Drag and drop the drive icon or the “Memory Stick” icon to the “Trash” icon, then remove the USB cable or “Memory Stick” or turn off the power.

- If you are using Mac OS X v10.0, remove the USB cable, etc., after you have turned your computer off.

3 Copying images

- 1 Double-click the newly recognized icon on the desktop.
The contents of the “Memory Stick” inserted in your camera appear.
 - 2 Double-click “DCIM.”
 - 3 Double-click the folder containing the desired image file.
 - 4 Drag and drop the image files to the hard disk icon.
The image files are copied to your hard disk.
- See pages 93 and 94 for details about the image file storage destinations and file names.

4 Viewing the images on your computer

- 1 Double-click the hard disk icon.
 - 2 Double-click the desired image file in the folder containing the copied files.
The image file opens.
- **Close down all applications running on the computer before installing the USB driver and application.**
 - You can use the “ImageMixer Ver. 1.5 for Sony” software to copy, view and edit images, and create video CDs. See the operation manual supplied with the CD-ROM for details about the installation method, or see the software’s help files for the operation method.
 - “ImageMixer” is not compatible with Mac OS X.
 - “Image Transfer” cannot be used with Macintosh.

For Mac OS X users

If the “There is no application available to open the document “DSC0□□□□.JPE”.” screen appears when you click an E-mail mode image file, make the following setting.

The screen display may differ depending on the version.

- 1 Click [Choose Application...] at the “There is no application available to open the document “DSC0□□□□.JPE”.” screen.
- 2 Change “Show” from [Recommended Applications] to [All Applications].
- 3 Select [QuickTime Player] from the displayed list of applications, and click [Open].

Troubleshooting

If you experience trouble with your camera, try the following solutions.

1 First check the items on the tables below.

If code displays “C:□□:□□” appear on the screen, the self-diagnosis display function is working (page 108).

2 Should your camera still not work properly, press the RESET button on the bottom of the camera using a fine-tipped object, then turn on the power again. (All the settings including date and time are cleared.)

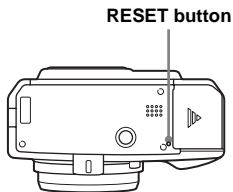







3 Should your camera still not work properly, consult your Sony dealer or local authorized Sony service facility.

Battery pack and power







Symptom	Cause	Solution
You cannot charge the battery pack.	<ul style="list-style-type: none">• The camera is turned on.	→ Turn the camera off (page 14).
The battery pack cannot be installed.	<ul style="list-style-type: none">• The battery pack is not installed correctly.	→ Install the battery pack while pushing the battery eject lever down using the front edge of the battery pack (page 10).
The $\frac{1}{2}$/CHG lamp flashes when charging a battery pack.	<ul style="list-style-type: none">• The battery pack is not installed correctly.• The battery pack has malfunctioned.	→ Install the battery pack correctly (page 10). → Consult your Sony dealer or local authorized Sony service facility.
The $\frac{1}{2}$/CHG lamp does not light up when charging a battery pack.	<ul style="list-style-type: none">• The AC Adaptor is disconnected.• The battery pack is not installed correctly.• The battery pack is completely charged.	→ Properly connect the AC Adaptor (page 10). → Install the battery pack correctly (page 10). —
The battery remaining indicator is incorrect, or sufficient battery remaining indicator is displayed but the power runs out soon.	<ul style="list-style-type: none">• You have used the camera for a long time in an extremely hot or an extremely cold location.• The battery pack is dead (page 121).• The battery pack is discharged.• A deviation has occurred in the remaining battery time.	— → Replace the battery pack with a new one. → Install a charged battery pack (page 10). → Fully charge the battery pack (page 11).















Symptom	Cause	Solution
The battery pack runs down too quickly.	<ul style="list-style-type: none"> You are shooting/viewing images in an extremely cold location. The DC plug is dirty so the battery pack is not charged enough. The battery pack is dead (page 121). 	<p>—</p> <ul style="list-style-type: none"> → Clean the pins of the AC Adaptor with a cotton swab, etc., and charge the battery pack (page 10). → Replace the battery pack with a new one.
You cannot turn on the camera.	<ul style="list-style-type: none"> The battery pack is not installed correctly. The AC Adaptor is disconnected. The battery pack is discharged. The battery pack is dead (page 121). 	<ul style="list-style-type: none"> → Install the battery pack correctly (page 10). → Properly connect the AC Adaptor (page 13). → Install a charged battery pack (page 10). → Replace the battery pack with a new one.
The power turns off suddenly.	<ul style="list-style-type: none"> If you do not operate the camera for about three minutes when using a battery pack, the camera turns off automatically to prevent wearing down the battery (when [Power Save] is [On] after 90 seconds) (page 14). The battery pack is discharged. 	<ul style="list-style-type: none"> → Turn on the camera again (page 14) or use the AC Adaptor (page 13). → Replace it with a charged battery pack (page 10).

Shooting still images/movies



Symptom	Cause	Solution
The LCD screen is not turned on even when the power is turned on.	<ul style="list-style-type: none"> The power was turned off with the LCD screen turned off the last time you used the camera. 	<ul style="list-style-type: none"> → Turn on the LCD screen (page 28).
The subject is not visible on the screen.	<ul style="list-style-type: none"> The mode dial is not set to , P, S, A, M, SCN or  (Clip Motion). 	<ul style="list-style-type: none"> → Set it to , P, S, A, M, SCN or  (Clip Motion) (pages 20 and 79).
The image is out of focus.	<ul style="list-style-type: none"> The subject is too close. The  (Twilight mode) or  (Landscape mode) is selected for the Scene Selection function. The focus preset function is selected. 	<ul style="list-style-type: none"> → Record in the macro recording mode. Make sure to position the lens farther away from the subject than the shortest shooting distance when shooting (page 24). → Set it to other modes (page 63). → Cancel the function (page 49).

Symptom	Cause	Solution
Zoom does not work.	<ul style="list-style-type: none"> The zoom magnification cannot be changed while shooting movies (MPEG Movie). You cannot use the zoom while a wide end conversion lens is mounted. 	— —
Smart zoom does not function.	<ul style="list-style-type: none"> You cannot use smart zoom while shooting movies (MPEG Movie). [Smart Zoom] is set to [Off] in the SET UP settings. The LCD screen is turned off. The image size is set to [5.0M] or [4.5M(3:2)]. 	— → Set [Smart Zoom] to [On] (pages 39 and 115). → Turn on the LCD screen (page 28). → Set image size to other settings except [5.0M] and [4.5M(3:2)] (page 18).
The image is too dark.	<ul style="list-style-type: none"> You are shooting a subject with a light source behind the subject. The brightness of the LCD screen is too low. 	→ Adjust the exposure (page 49). → Adjust the brightness of the LCD screen (pages 39 and 117).
The image is too bright.	<ul style="list-style-type: none"> You are shooting a spotlighted subject in a dark location such as on a stage. The brightness of the LCD screen is too bright. 	→ Adjust the exposure (page 49). → Adjust the brightness of the LCD screen (pages 39 and 117).
Vertical streaks appear when you are shooting a very bright subject.	<ul style="list-style-type: none"> The smear phenomenon is occurring. 	→ This is not a malfunction.
Noise appears in the image when you view the LCD screen in a dark place.	<ul style="list-style-type: none"> The camera is functioning to increase the visibility of the LCD screen by temporarily brightening the image under conditions of low illumination. 	→ There is no effect on the recorded image.

Symptom	Cause	Solution
Your camera cannot record images.	<ul style="list-style-type: none"> No “Memory Stick” has been inserted. The capacity of the “Memory Stick” is insufficient. The write-protect switch on the “Memory Stick” is set to the LOCK position. You cannot record images while charging the flash. The mode dial is not set to , P, S, A, M or SCN when shooting a still image. The mode dial is not set to  when shooting a movie. 	<ul style="list-style-type: none"> → Insert a “Memory Stick” (page 17). → Delete the images saved in the “Memory Stick” (page 34) or format it (page 37). → Change the “Memory Stick” (page 17). → Set it to the recording position (page 119). — → Set it to , P, S, A, M, or SCN (page 20). → Set it to  (page 79).
Recording takes a long time.	<ul style="list-style-type: none"> NR slow shutter function is activated. 	<ul style="list-style-type: none"> → Set to a faster shutter speed than 1/25 second when [ISO] is [800], or a faster shutter speed than 1/6 second when [ISO] is other than [800] (page 44).
A sound is made if the NIGHTSHOT/NIGHTFRAMING lever is changed, or if the shutter button is lightly pressed while NIGHTFRAMING is set.	<ul style="list-style-type: none"> The sound is made by the lens in operation. 	<ul style="list-style-type: none"> → This is not a malfunction.
The image colors are not correct.	<ul style="list-style-type: none"> NIGHTSHOT or NIGHTFRAMING is set. 	<ul style="list-style-type: none"> → Cancel the Nightshot/NightFraming functions (pages 56 and 57).
NightShot or NightFraming does not function.	<ul style="list-style-type: none"> The mode dial is set to S, A, M or SCN. 	<ul style="list-style-type: none"> → Set it to , P or  (NightFraming for Clip Motion) (pages 56 and 57).

Symptom	Cause	Solution
The built-in flash or the optional external flash (HVL-F32X or HVL-F1000) does not work.	<ul style="list-style-type: none"> The mode dial is not set to , P, S, A, M, SCN or  (Clip Motion). The flash is set to  (No flash). The  (Twilight mode) is selected for the Scene Selection function. The  (Landscape mode),  (Snow mode) or  (Beach mode) is selected for the Scene Selection function. [Moving Image] in the SET UP settings is set to [MPEG Movie] or [Multi Burst]. [Mode] (REC Mode) in the menu settings is set to [Burst 3] or [Exp Brktg]. [Hot Shoe] in the SET UP settings is set to [On]. NightShot is activated. 	<ul style="list-style-type: none"> → Set it to , P, S, A, M, SCN or  (Clip Motion) (pages 20 and 58). → Set the flash to auto (No indicator),  (Forced flash) or  (Slow synchro) (page 26). → Set it to other settings (page 63). → Set the flash to  (Forced flash) (page 26). → Set it to [Clip Motion]. → Set it to other settings. → Set it to [Off] (pages 39 and 116). → Set to NIGHTFRAMING or cancel the NightShot function (pages 57 and 56).
The macro function does not work.	<ul style="list-style-type: none"> The  (Twilight mode) or  (Landscape mode) is selected for the Scene Selection function. 	<ul style="list-style-type: none"> → Set it to other settings (page 63).
The eyes of the subject come out red.	—	<ul style="list-style-type: none"> → Set [Red Eye Reduction] in the SET UP settings to [On] (pages 26 and 115).
The date and time are recorded incorrectly.	<ul style="list-style-type: none"> The date and time are not set correctly. 	<ul style="list-style-type: none"> → Set the correct date and time (page 15).
The F value and shutter speed flash when you press and hold the shutter button halfway down.	<ul style="list-style-type: none"> The exposure is incorrect. 	<ul style="list-style-type: none"> → Correct the exposure (page 49).

Viewing images

Symptom	Cause	Solution
Your camera cannot play back images.	<ul style="list-style-type: none"> • The mode dial is not set to . • Your camera cannot play back image files copied from the hard disk of your computer if the folder/file name has been changed or the image has been modified. • The camera is in USB mode. 	→ Set it to  (page 30). — → Cancel USB communication (page 90).
The image appears rough right after playback starts.	—	→ This is not a malfunction.
The image does not appear on the TV screen.	<ul style="list-style-type: none"> • The video output signal setting of your camera in the SET UP settings is incorrect. • The connection is not correct. 	→ Change the setting (pages 39 and 117). → Check the connection (page 32).
The image cannot be played back on a computer.	—	→ See page 103.
Unknown beeps are heard from the camera while viewing a movie.	<ul style="list-style-type: none"> • These beeps are heard when the auto focus is working. 	→ This is not a malfunction. Shoot the image using the focus preset (page 48).

Deleting/Editing Images

Symptom	Cause	Solution
Your camera cannot delete an image.	<ul style="list-style-type: none"> • The image is protected. • The write-protect switch on the “Memory Stick” is set to the LOCK position. 	→ Cancel the protection (page 74). → Set it to the recording position (page 119).
You have deleted an image by mistake.	<ul style="list-style-type: none"> • Once you have deleted an image, you cannot restore it. 	→ Marking  (protect) will prevent you from deleting images by mistake (page 74). → We recommend that you set the “Memory Stick” write-protect switch to the LOCK position to prevent accidental erasure (page 119).
The resizing function does not work.	<ul style="list-style-type: none"> • You cannot resize movies (MPEG Movie), Clip Motion, Multi Burst and uncompressed (TIFF) images. 	—

Symptom	Cause	Solution
You cannot display a print (DPOF) mark.	<ul style="list-style-type: none"> You cannot display print (DPOF) marks on movies and Clip Motion images. 	—
You cannot cut a movie.	<ul style="list-style-type: none"> The movie (MPEG Movie) is not long enough to cut. Protected movie (MPEG Movie), Clip Motion, Multi Burst files and still images cannot be cut. 	—

Computers

Symptom	Cause	Solution
You do not know if the OS of your computer is compatible.	—	→ Check “Recommended computer environment” (pages 85 and 95).
You cannot install the USB driver.	—	→ In Windows 2000, log on as Administrator (authorized Administrators) (page 85).
Your computer does not recognize your camera.	<ul style="list-style-type: none"> The camera is turned off. The battery level is low. You are not using the supplied USB cable. The USB cable is not connected firmly. <ul style="list-style-type: none"> [USB Connect] is set to [PTP] in the SET UP settings. The USB connectors on your computer are connected to other equipment besides the keyboard, the mouse, and your camera. The camera is not connected directly to your computer. The USB driver is not installed. Your computer does not properly recognize the device because you connected the camera and your computer with the USB cable before you installed the “USB Driver” from the supplied CD-ROM. 	<ul style="list-style-type: none"> → Turn on the camera (page 14). → Use the AC Adaptor (page 13). → Use the supplied USB cable (pages 89 and 95). → Disconnect the USB cable, and connect it again firmly. Make sure that “USB Mode” is displayed on the screen (pages 89 and 95). → Set it to [Normal] (page 117). <ul style="list-style-type: none"> → Disconnect all equipment other than your camera from the USB connectors. <ul style="list-style-type: none"> → Connect the camera directly to your computer without passing through a USB hub or other device. → Install the USB driver (pages 86 and 95). → Delete the erroneously recognized device from your computer, then install the USB driver (pages 91 and 86).

Symptom	Cause	Solution
You cannot copy images.	<ul style="list-style-type: none"> • The camera is not correctly connected to your computer. • You are not using the correct copy procedure for your OS. — — 	<ul style="list-style-type: none"> → Connect the camera and your computer correctly using the USB cable (pages 89 and 95). → Follow the designated copy procedure for your OS (pages 90, 91, 92 and 96). → If you use the “Image Transfer” software, see page 90. → If you are using the “ImageMixer Ver. 1.5 for Sony” application software, click on HELP.
After making a USB connection, “Image Transfer” does not automatically start.	<ul style="list-style-type: none"> — — 	<ul style="list-style-type: none"> → Select [Launch Image Transfer automatically when your camera, etc., is connected.] at [Basic] setting (page 91). → Make a USB connection when the computer is turned on (page 89).
The image cannot be played back on a computer.	<ul style="list-style-type: none"> — — 	<ul style="list-style-type: none"> → If you are using the “ImageMixer Ver. 1.5 for Sony” application software, click on HELP. → Consult the computer or software manufacturer.
The image and sound are interrupted by noise when you view a movie on a computer.	<ul style="list-style-type: none"> • You are playing back the file directly from the “Memory Stick”. 	<ul style="list-style-type: none"> → Copy the file to the hard disk of your computer and then play back the file from the hard disk (pages 90, 91, 92 and 96).
You cannot print an image.	<ul style="list-style-type: none"> — — 	<ul style="list-style-type: none"> → Check the printer settings. → Click on the HELP for the “ImageMixer Ver. 1.5 for Sony” application software.
An error message appears when you set the supplied CD-ROM in your computer.	<ul style="list-style-type: none"> • The computer display is not set correctly. 	<ul style="list-style-type: none"> → Set the computer display as follows: Windows: 800 × 600 dots or more High Color (16 bits, 65,000 colors) or more Macintosh: 800 × 600 dots or more 32,000-color or more

“Memory Stick”

Symptom	Cause	Solution
You cannot insert a “Memory Stick.”	<ul style="list-style-type: none"> • You are inserting it backwards. 	<ul style="list-style-type: none"> → Insert it from the right side (page 17).

Symptom	Cause	Solution
You cannot record on a “Memory Stick.”	<ul style="list-style-type: none"> The write-protect switch on the “Memory Stick” is set to the LOCK position. The “Memory Stick” is full. 	<p>→ Set it to the recording position (page 119).</p> <p>→ Delete unnecessary images (pages 34 and 81).</p>
You cannot format a “Memory Stick.”	<ul style="list-style-type: none"> The write-protect switch on the “Memory Stick” is set to the LOCK position. 	<p>→ Set it to the recording position (page 119).</p>
You have formatted a “Memory Stick” by mistake.	<ul style="list-style-type: none"> All the data on the “Memory Stick” are deleted by formatting. You cannot restore them. 	<p>→ We recommend that you set the “Memory Stick” write-protect switch to the LOCK position to prevent accidental erasure (page 119).</p>







Others

Symptom	Cause	Solution
Your camera does not work.	<ul style="list-style-type: none"> You are not using an “InfoLITHIUM” battery pack. The battery level is low. (The  indicator appears.) The AC Adaptor is not connected securely. 	<p>→ Use an “InfoLITHIUM” battery pack (page 120).</p> <p>→ Charge the battery pack (page 10).</p> <p>→ Connect it securely to the DC IN jack of your camera and to a wall outlet (page 13).</p>
The power is on, but the camera does not work.	<ul style="list-style-type: none"> The built-in microcomputer is not working properly. 	<p>→ Disconnect, and then, after one minute, reconnect all power sources and turn on the camera. If this does not work, press the RESET button on the bottom of the camera with a pointed object, then turn the power on again. (This will clear the date and time settings, etc.)</p>
You cannot identify an indicator on the screen.	—	<p>→ Check the indicator (page 124).</p>
The lens gets fogged.	<ul style="list-style-type: none"> Moisture condensation has occurred. 	<p>→ Turn off the camera and leave for about an hour at room temperature for the moisture to evaporate before use (page 118).</p>
The camera becomes warm when you use it for the long time.	—	<p>→ This is not a malfunction.</p>
The lens does not move when you turn off the camera.	<ul style="list-style-type: none"> The battery pack is discharged. 	<p>→ Replace it with a charged battery pack or use the AC Adaptor (pages 10 and 13).</p>

Warnings and messages

The following messages may appear on the screen.

Message	Meaning/Corrective Action
No Memory Stick	<ul style="list-style-type: none">• Insert a “Memory Stick” (page 17).
System error	<ul style="list-style-type: none">• Turn the power off and on again (page 14).
Memory Stick error	<ul style="list-style-type: none">• The inserted “Memory Stick” cannot be used in your camera (page 119).• The “Memory Stick” is damaged, or the terminal section of the “Memory Stick” is dirty.• Insert the “Memory Stick” correctly (page 17).
Memory Stick type error	<ul style="list-style-type: none">• The inserted “Memory Stick” cannot be used in your camera (page 119).
Format error	<ul style="list-style-type: none">• Failed to format the “Memory Stick.” Format the “Memory Stick” again (page 37).
Memory Stick locked	<ul style="list-style-type: none">• The write-protect switch on the “Memory Stick” is set to the LOCK position. Set it to the recording position (page 119).
No memory space	<ul style="list-style-type: none">• The capacity of the “Memory Stick” is insufficient. You cannot record images. Delete unnecessary images (pages 34 and 81).
No file in this folder	<ul style="list-style-type: none">• No images have been recorded in this folder.
Folder error	<ul style="list-style-type: none">• A folder with the same first three digits number already exists in the “Memory Stick.” (For example: 123MSDCF and 123ABCDE) Select other folders, or create a new folder.
Cannot create more folders	<ul style="list-style-type: none">• The folder whose first three digits of the name is “999” exists in the “Memory Stick.” You cannot create any folders.
Cannot record	<ul style="list-style-type: none">• The camera cannot record images in the selected folder. Select a different folder (page 41).
File error	<ul style="list-style-type: none">• An error occurred while playing back the image.
File protect	<ul style="list-style-type: none">• The image is protected against erasure. Release the protection (page 74).
For "InfoLITHIUM" battery only	<ul style="list-style-type: none">• The battery pack is not the “InfoLITHIUM” type.
Image size over	<ul style="list-style-type: none">• You are playing back an image of a size that cannot be played back on your camera.
Can not divide	<ul style="list-style-type: none">• The movie is not long enough to be divided.• The file is not a movie (MPEG Movie).
Invalid operation	<ul style="list-style-type: none">• You are playing back a file that was created on equipment other than this camera.

Message	Meaning/Corrective Action
	<ul style="list-style-type: none"> The battery level is low or zero. Charge the battery pack (page 10). Depending on the conditions of use or the type of battery pack, the indicator may flash even though there are still 5 to 10 minutes of remaining battery time left.
	<ul style="list-style-type: none"> The amount of lights is not sufficient, so you are not holding the camera steady enough. Use the flash, mount the camera on a tripod, or otherwise secure the camera in place.
“Night Shot”	<ul style="list-style-type: none"> An operation that is not valid while NIGHTSHOT is set is attempted.
“Night Framing”	<ul style="list-style-type: none"> An operation that is not valid while NIGHTFRAMING is set is attempted.
Night shot is invalid	<ul style="list-style-type: none"> The mode dial is set to a position other than , P or  while NIGHTSHOT is set.
Night framing is invalid	<ul style="list-style-type: none"> The mode dial is set to a position other than , P or  (Clip Motion) while NIGHTFRAMING is set.
Turn the power off and on again	<ul style="list-style-type: none"> A problem with the lens caused an error.

Self-diagnosis display

– If a code starting with an alphabet letter appears

Your camera has a self-diagnosis display. This function displays the camera condition on the LCD screen with a combination of a letter and four numerical digits. If this occurs, check the following code chart and attempt the corresponding corrective actions. The last two digits (indicated by □□) will differ depending on the state of the camera.

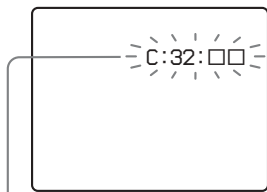

Self-diagnosis display

Code	Cause	Corrective action
C:32: □□	There is trouble with your camera's hardware.	Turn the power off and on again (page 14).
C:13: □□	The camera cannot read or write data on the "Memory Stick."	Re-insert the "Memory Stick" several times.
	An unformatted "Memory Stick" is inserted.	Format the "Memory Stick" (page 37).
	The inserted "Memory Stick" cannot be used with your camera, or the data is damaged.	Insert a new "Memory Stick" (page 17).
E:61: □□ E:91: □□	A camera malfunction that you cannot reverse has occurred.	Press the RESET button (page 97) located on the bottom of the camera, then turn on the power again.

If you are unable to solve the problem even after trying the corrective actions a few times, contact your Sony dealer or local authorized Sony service facility and inform them of the 5-digit code.

Number of images that can be saved or shooting time

The number of images that can be saved and the shooting time differ, depending on the capacity of the “Memory Stick,” the image size, and the image quality. Refer to the following charts when you choose a “Memory Stick.”

- The number of images is listed in Fine (Standard) order.
- The values for the number of images that can be saved and the shooting time may vary, depending on the shooting conditions.
- For normal shooting times and numbers of images that can be saved, see page 19.
- When the number of remaining shooting images is greater than 9999, the “>9999” indicator appears on the LCD screen.

Clip Motion

(Units: images)

	16MB	32MB	64MB	128MB	MSX-256	MSX-512	MSX-1G
Normal	88	178	358	718	1190	2420	4940
Mobile	486	982	1971	3951	3571	7261	14821

Normal: When 10 frames are shot

Mobile: When two frames are shot

Multi Burst

(Units: images)

	16MB	32MB	64MB	128MB	MSX-256	MSX-512	MSX-1G
1.2M	24 (46)	50 (93)	101 (187)	202 (376)	357 (649)	726 (1320)	1482 (2694)

TIFF

(Units: images)

	16MB	32MB	64MB	128MB	MSX-256	MSX-512	MSX-1G
5.0M	0 (0)	1 (1)	3 (3)	7 (7)	13 (14)	26 (28)	54 (58)
4.5M(3:2)	0 (1)	2 (2)	4 (4)	8 (8)	14 (15)	29 (32)	60 (65)
3.1M	0 (0)	1 (2)	3 (4)	7 (8)	14 (14)	28 (29)	58 (60)
1.2M	1 (1)	2 (2)	4 (4)	8 (8)	14 (15)	30 (30)	61 (62)
VGA	1 (1)	2 (2)	4 (4)	8 (8)	15 (15)	31 (31)	63 (63)

E-Mail

(Units: images)

	16MB	32MB	64MB	128MB	MSX-256	MSX-512	MSX-1G
5.0M	6 (11)	12 (23)	25 (47)	51 (95)	91 (170)	186 (345)	380 (705)
4.5M(3:2)	6 (11)	12 (23)	25 (47)	51 (95)	91 (170)	186 (345)	380 (705)
3.1M	10 (18)	20 (36)	40 (73)	81 (146)	145 (255)	296 (518)	604 (1058)
1.2M	24 (44)	49 (89)	98 (179)	197 (359)	340 (595)	691 (1210)	1411 (2470)
VGA	88 (194)	178 (392)	358 (788)	718 (1580)	1190 (2381)	2420 (4841)	4940 (9881)

Voice

(Units: images)

	16MB	32MB	64MB	128MB	MSX-256	MSX-512	MSX-1G
5.0M	6 (11)	12 (22)	25 (45)	50 (91)	90 (166)	183(337)	375 (689)
4.5M(3:2)	6 (11)	12 (22)	25 (45)	50 (91)	90 (166)	183(337)	375 (689)
3.1M	9 (17)	19 (34)	39 (69)	79 (138)	142 (246)	290 (500)	592 (1022)
1.2M	22 (38)	45 (78)	91 (157)	183 (316)	324 (549)	660 (1117)	1347 (2280)
VGA	69 (121)	140 (245)	281 (492)	564 (987)	1020 (1785)	2074 (3630)	4234 (7410)

MPEG Movie

(Units: seconds)

	16MB	32MB	64MB	128MB	MSX-256	MSX-512	MSX-1G
640 (VGA)	42	87	176	354	641	1304	2663
160 (Mail)	673	1363	2740	5494	9935	20203	41239

Menu items

Menu items that can be modified differ depending on the position of the mode dial.















The screen shows only the items you can operate in each specific mode.

Factory settings are indicated with ■.

When the mode dial is set to







Item	Setting	Description
Mode (REC Mode)	TIFF Voice E-Mail Exp Brktg Burst 3 ■Normal	<ul style="list-style-type: none">– Records an uncompressed (TIFF) file in addition to the JPEG file (page 61).– Records an audio file (with a still image) in addition to the JPEG file (page 62).– Records a small-size (320×240) JPEG file in addition to the selected image size (page 62).– Records three images with the exposure value of each image slightly shifted (page 53).– Records three images in succession (page 60).– Records an image using the normal recording mode.

When the mode dial is set to P, S, A, M, or SCN















Item	Setting	Description
SCN	 /  /  /  /  / 	Sets the Scene Selection mode (page 63). (This setting can be made only in SCN mode.)
 (Metering Mode)	Spot / Center / ■Multi	Adjusts the exposure to the subject you are shooting (page 51).
WB (White Bal)	 /  /  /  /  /  / ■Auto	Sets the white balance (page 55).
ISO	800 / 400 / 200 / 100 / ■Auto	This selects the ISO sensitivity. Select a large number when shooting in dark locations or shooting a subject moving at high speed, or select a small number to obtain high image quality. (This setting cannot be made in SCN mode.)
 (P.Quality)	■Fine / Standard	Records images with fine/standard quality (page 41).

Item	Setting	Description
Mode (REC Mode)	TIFF Voice E-Mail Exp Brktg Burst 3 ■Normal	<ul style="list-style-type: none"> – Records an uncompressed (TIFF) file in addition to the JPEG file (page 61). – Records an audio file (with a still image) in addition to the JPEG file (page 62). – Records a small-size (320×240) JPEG file in addition to the selected image size (page 62). – Records three images with the exposure value of each image slightly shifted (page 53). – Records three images in succession (page 60). – Records an image using the normal recording mode.
± (Flash Level)	High / ■Normal / Low	Selects the amount of flash light (page 58).
PFX (P.Effect)	Solarize / Sepia / Neg. Art / ■Off	Sets the image special effects (page 65).
[F] (Sharpness)	+ / ■Normal / –	Adjusts the sharpness of the image. The [F] indicator appears (except when the setting is Normal.) (This setting cannot be made in SCN mode.)
⊕ (Saturation)	+ / ■Normal / –	Adjusts the saturation of the image. The ⊕ indicator appears (except when the setting is Normal.) (This setting cannot be made in SCN mode.)
● (Contrast)	+ / ■Normal / –	Adjusts the contrast of the image. The ● indicator appears (except when the setting is Normal.) (This setting cannot be made in SCN mode.)

















When the mode dial is set to (when [Moving Image] is set to [MPEG Movie] in the SET UP settings)

Item	Setting	Description
◻ (Metering Mode)	Spot / Center / ■Multi	Adjusts the exposure to the subject you are shooting (page 51).
WB (White Bal)	 / $\frac{1}{\text{WB}}$ /  /  /  /  /  / ■Auto	Sets the white balance (page 55).
PFX (P.Effect)	Solarize / Sepia / Neg. Art / ■Off	Sets the image special effects (page 65).



When the mode dial is set to (when [Moving Image] is set to [Clip Motion] in the SET UP settings)

Item	Setting	Description
 (Metering Mode)	Spot / Center /  Multi	Adjusts the exposure to the subject you are shooting (page 51).
WB (White Bal)	 /  WB /  /  /  /  /  /  /  Auto	Sets the white balance (page 55).
 ± (Flash Level)	High /  Normal / Low	Selects the amount of flash light (page 58).
PFX (P.Effect)	Solarize / Sepia / Neg. Art /  Off	Sets the image special effects (page 65).

When the mode dial is set to (when [Moving Image] is set to [Multi Burst] in the SET UP settings)

Item	Setting	Description
 (Metering Mode)	Spot / Center /  Multi	Adjusts the exposure to the subject you are shooting (page 51).
WB (White Bal)	 /  WB /  /  /  /  /  /  Auto	Sets the white balance (page 55).
 (Interval)	1/7.5 / 1/15 /  1/30 (NTSC) 1/6.3 / 1/12.5 /  1/25 (PAL)	<ul style="list-style-type: none">- Selects the Multi Burst shutter interval in NTSC mode.- Selects the Multi Burst shutter interval in PAL mode.• The shutter interval settings differ depending on the setting of the [Video Out] item in the SET UP settings (page 117).
 (P.Quality)	 Fine / Standard	Records images with fine/standard quality (page 41).
PFX (P.Effect)	Solarize / Sepia / Neg. Art /  Off	Sets the image special effects (page 65).

When the mode dial is set to

Item	Setting	Description
Folder	OK / Cancel	Selects the folder containing the image you want to play back (page 68).
Protect	—	Protects and unprotects images against accidental erasure (page 74).
DPOF	—	Marks and unmarks the print (DPOF) mark on still images you want to print (page 76).
Slide	Interval Image Repeat Start Cancel	<ul style="list-style-type: none"> – Sets the slide show interval (page 70). (Only in single-image mode.) <ul style="list-style-type: none"> ■ 3 sec / 5 sec / 10 sec / 30 sec / 1 min – Sets the range of the playback images. <ul style="list-style-type: none"> ■ Folder / All – Plays back images repeatedly. <ul style="list-style-type: none"> ■ On / Off – Starts the slide show. – Cancels the slide show.
Resize	5.0M / 3.1M / 1.2M / VGA / Cancel	Changes the recorded still image size (page 76). (Only in single-image mode.)
Rotate	 (counter clockwise) /  (clockwise) / OK / Cancel	Rotates the still image (page 71). (Only in single-image mode.)
Divide	OK / Cancel	Divides movie (page 83). (Only in single-image mode.)

SET UP items







Set the mode dial to SET UP. The SET UP screen appears.

Factory settings are indicated with ■.

(Camera 1)

Item	Setting	Description
Moving Image	■MPEG Movie / Clip Motion / Multi Burst	Selects the shooting mode for a movie (pages 79, 58 and 60).
AF Mode	■Single / Monitor / Cont	Selects the focus operation mode (page 47).
Smart Zoom	■On / Off	Selects whether to use the smart zoom (page 23).
Date/Time	Day & Time / Date / ■Off	Selects whether to superimpose the date or time onto the image (page 29). The date and time are not inserted in movie (MPEG Movie), Clip Motion or Multi Burst mode. Also, the date and time appear only during playback, and do not appear during recording.
Red Eye Reduction	On / ■Off	Reduces the red-eye phenomenon when using a flash (page 26).
Hologram AF	■Auto / Off	Selects whether to emit hologram AF light. Used when it is difficult to focus on the subject in dark conditions (page 27).

(Camera 2)

Item	Setting	Description
Bracket Step	$\pm 1.0\text{EV}$ /  $\pm 0.7\text{EV}$ / $\pm 0.3\text{EV}$	Sets the exposure compensation value when recording three images with each exposure value shifted (page 53).
Hot Shoe	On /  Off	Set to [On] when using a commercially available external flash (page 65).
Zoom Lever	W  T  /  T  W 	Sets the zoom lever W (wide) side/T (telephoto) side directions (page 23).

(Memory Stick Tool)

Item	Setting	Description
Format	OK / Cancel	Formats the “Memory Stick.” Note that formatting erases all data on a “Memory Stick,” including even protected images (page 37).
File Number	 Series Reset	<ul style="list-style-type: none">– Assigns numbers to files in sequence even if the “Memory Stick” is changed or the recording folder is changed.– Resets the file numbering and starts from 0001 each time the folder is changed. (When the recording folder contains a file, a number one higher than the largest number is assigned.)
Create REC. Folder	OK / Cancel	Creates a folder for recording images (page 41).
Change REC. Folder	OK / Cancel	Changes a folder for recording images (page 41).

(Setup 1)

Item	Setting	Description
Power Save	On / <input type="checkbox"/> Off	Selects whether to use the Power Save mode (page 12). Displayed only when you are using the camera with the battery pack.
LCD Brightness	Bright / <input checked="" type="checkbox"/> Normal / Dark	Selects the LCD brightness. This has no effect on the recorded images.
LCD Backlight	Bright / Normal / <input checked="" type="checkbox"/> Dark	Selects the brightness of the LCD backlight. Selecting [Bright] makes the screen bright and easy to see when using the camera outdoors or in other bright locations, but also uses up the battery charge faster. Displayed only when using your camera with the battery pack.
Beep	Shutter <input checked="" type="checkbox"/> On Off	<ul style="list-style-type: none">– Turns on the shutter sound. (The shutter sound is heard when you press the shutter button.)– Turns on the beep/shutter sound when you press the control button/shutter button.– Turns off the beep/shutter sound.
 Language	—	Displays the menu items, warnings and messages in selected language.
Clock Set	OK / Cancel	Sets the date and time (pages 15 and 39).

(Setup 2)

Item	Setting	Description
USB Connect	PTP / <input checked="" type="checkbox"/> Normal	Switches the USB mode (pages 85 and 95).
Video Out	NTSC PAL	<ul style="list-style-type: none">– Sets the video output signal to NTSC mode (e.g., USA, Japan).– Sets the video output signal to PAL mode (e.g., Europe).

Precautions

Do not leave the camera in the following places

- In extremely hot place, such as in a car parked in the sun. The camera body may become deformed or this may cause a malfunction.
- Under direct sunlight or near a heater. The camera body may become deformed or this may cause a malfunction.
- On rocking vibration
- Near strong magnetic place
- In sandy or dusty places, be careful not to let sand or dust get into the camera. This may cause the camera to malfunction, and in some cases this malfunction cannot be repaired.

On cleaning

Cleaning the LCD screen

Wipe the screen surface with an LCD cleaning kit (not supplied) to remove fingerprints, dust, etc.

Cleaning the lens

Wipe the lens with a soft cloth to remove fingerprints, dust, etc.

Cleaning the DC plug

Clean the DC plug of the AC Adaptor with a dry cotton bud. Do not use the dirty plug. Use of the dirty plug may not properly charge the battery pack.

Cleaning the camera surface

Clean the camera surface with a soft cloth slightly moistened with water, then wipe the surface with a dry cloth. Do not use the following as this may damage the finish or the casing.

- Thinner
- Benzine
- Alcohol
- Disposable cloth
- Volatile insecticide
- Contact with rubber or vinyl for a long time

Note on operating temperature

Your camera is designed for use between the temperatures of 0°C and 40°C (32°F and 104°F). Shooting in extremely cold or hot places that exceed this range is not recommended.

On moisture condensation

If the camera is brought directly from a cold to a warm location, or is placed in a very damp room, moisture may condense inside or outside the camera. This moisture condensation may cause a malfunction of the camera.

Moisture condensation occurs easily when:

- The camera is brought from a cold location such as a ski slope into a warmly heated room.
- The camera is taken from an air-conditioned room or car interior to the hot outdoors, etc.

How to prevent moisture condensation

When bringing the camera from a cold place to a warm place, seal the camera in a plastic bag and allow it to adapt to conditions at the new location over a period of time (about an hour).

If moisture condensation occurs

Turn off the camera and wait about an hour for the moisture to evaporate. Note that if you attempt to shoot with moisture remaining inside the lens, you will be unable to record clear images.

On internal rechargeable button battery

This camera has an internal rechargeable button battery for maintaining the date and time and other settings regardless of whether the power is on or off.

This rechargeable button battery is continually charged as long as you are using the camera. However, if you use the camera for only short periods it discharges gradually, and if you do not use the camera at all for about one month it becomes completely discharged. In this case, be sure to charge this rechargeable button battery before using the camera.

However, even if this rechargeable button battery is not charged, you can still use the camera as long as you do not record the date and time.

Charging method

Connect the camera to a wall outlet (mains) using the AC Adaptor, or install a charged battery pack, and leave the camera for 24 hours or more with the power off.

- The rechargeable button battery is located inside the cover next to the tripod screw hole on the bottom of the camera. Never remove the rechargeable button battery except when disposing of the camera.

On "Memory Stick"

"Memory Stick" is a new compact, portable and versatile IC recording medium with a data capacity that exceeds the capacity of a floppy disk.

In addition to exchanging data between "Memory Stick" compatible equipment, you can also use a "Memory Stick" to store data as a type of detachable external recording media.

There are two types of "Memory Stick": an ordinary "Memory Stick" and a "MagicGate Memory Stick" that is equipped with the MagicGate* copyright protection technology. You can use both types of "Memory Stick" with your camera.

However, because your camera does not support the MagicGate standards, data recorded with your camera is not subject to MagicGate copyright protection.

In addition, you can also use "Memory Stick Duo" or "Memory Stick PRO" with your camera.

* MagicGate is copyright protection technology that uses encryption technology.

- "Memory Stick" formatted with a computer is not guaranteed to operate with this camera.

"Memory Stick" type	Recording/ playback with this camera
Memory Stick (Memory Stick Duo)	○
MagicGate Memory Stick (MagicGate Memory Stick Duo)	○**
Memory Stick PRO	○**

** The camera cannot record or play back the data needed by the MagicGate function.
All Memory Stick media operations are not necessarily guaranteed.

Notes on using the supplied "Memory Stick"

- You cannot record or delete images when the write-protect switch is set to LOCK.

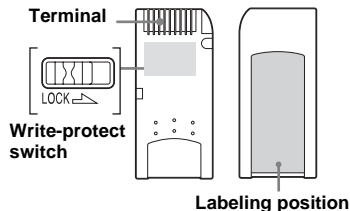

The position or the shape of the write-protect switch may differ depending on the "Memory Stick" you use.

- Do not remove the "Memory Stick" while reading or writing data.

- Data may be corrupted in the following cases.
 - When the “Memory Stick” is removed or the camera is turned off during read or write operation
 - When the “Memory Stick” is used in locations subject to static electricity or electrical noise
- We recommend backing up important data.
- Do not attach any other material than the supplied label on the labeling position.
- Attach the label in the prescribed label location, taking care that the label does not extend from this location.
- When you carry or store the “Memory Stick,” put it in the case supplied with it.
- Do not touch the terminal of a “Memory Stick” with your hand or a metal object.
- Do not strike, bend or drop a “Memory Stick.”
- Do not disassemble or modify a “Memory Stick.”
- Do not expose the “Memory Stick” to water.
- Do not use or keep the “Memory Stick” under the following conditions:
 - High temperature locations such as the hot interior of a car parked in direct sunlight
 - Locations exposed to direct sunlight
 - Humid locations or locations with corrosive substances

Notes on using “Memory Stick Duo” (not supplied)

- When using a “Memory Stick Duo” with your camera, be sure to insert the “Memory Stick Duo” into a Memory Stick Duo Adaptor.
- When inserting a “Memory Stick Duo” into a Memory Stick Duo Adaptor, check to make sure the “Memory Stick Duo” is inserted facing the correct direction.
- When using a “Memory Stick Duo” inserted into a Memory Stick Duo Adaptor with this camera, make sure that the “Memory Stick Duo” is inserted facing the correct direction. Note that improper use may damage the equipment.
- Do not insert a Memory Stick Duo Adaptor without a “Memory Stick Duo” attached. Doing so may result in malfunction of the unit.

Note on using “Memory Stick PRO” (not supplied)

“Memory Stick PRO” with a capacity up to 1GB can be used with this camera.

On “InfoLITHIUM” battery pack



What is the “InfoLITHIUM” battery pack?

The “InfoLITHIUM” battery pack is a lithium-ion battery pack that has functions for communicating information related to operating conditions of your camera. The “InfoLITHIUM” battery pack calculates the power consumption according to the operating conditions of your camera, and displays the remaining battery time in minutes.

Charging the battery pack

We recommend charging the battery pack in an ambient temperature of between 10°C to 30°C (50°F to 86°F). You may not be able to efficiently charge the battery pack outside of this temperature range.

Effective use of the battery pack

- Battery performance decreases in low-temperature surroundings. So, the time that the battery pack can be used is shorter in cold places. We recommend the following to ensure longer battery pack use:
 - Put the battery pack in a pocket close to your body to warm it up, and insert it in your camera immediately before you start shooting.
- Frequently operating the zoom or flash wears out the battery charge faster.
- We recommend having spare battery packs handy for two or three times the expected shooting time, and making trial shots before taking the actual shots.
- Do not expose the battery pack to water. The battery pack is not water-resistant.

Remaining battery time indicator

The power may go off although the battery remaining indicator shows there is enough power to operate. Use the battery pack up and charge the battery pack fully again so that the indication on the battery remaining indicator is correct. Note, however, that the correct battery indication sometimes will not be restored if the camera is used in high temperatures for a long time or left in a fully charged state, or the battery pack is frequently used.

How to store the battery pack

- If the battery pack is not to be used for a long time, do the following procedure once per year to maintain proper function.
 - 1 Fully charge the battery.
 - 2 Discharge on your camera.
 - 3 Remove the battery from your camera and store it in a dry, cool place.
- To use the battery pack up on your camera, leave the POWER button to on in slide show playback mode (page 70) until the power goes off.

Battery life

- The battery life is limited. Battery capacity decreases little by little as you use it more and more, and as time passes. When the battery operating time is shortened considerably, a probable cause is that the battery pack has reached the end of its life. Buy a new battery pack.
- The battery life varies according to how it is stored and the operating conditions and environment for each battery pack.

Specifications

■ Camera

[System]

Image device

9.04 mm (1/1.8 type) color CCD
Primary color filter

Total pixels number of camera

Approx. 5 255 000 pixels

Effective pixels number of camera

Approx. 5 090 000 pixels

Lens

4× zoom lens
f = 7.0 – 28.0 mm (34 – 136 mm when
converted to a 35 mm still camera)
F2.8 – 4.0

Exposure control

Automatic exposure, Shutter speed
priority, Aperture priority, Manual
exposure, Scene selection (6 modes)

White balance

Automatic, Daylight, Cloudy,
Fluorescent, Incandescent, Flash,
One-push

File format (DCF compliant)

Still images: Exif Ver. 2.2 JPEG
compliant, GIF (for Clip Motion),
TIFF, DPOF compatible
Audio with still image: MPEG1
compliant (Monaural)
Movies: MPEG1 compliant
(Monaural)

Recording media

“Memory Stick”

Flash

Recommended distance (ISO set to
Auto):
0.4 m to 2.8 m (15 3/4 inches to
110 1/4 inches) (W)
0.4 m to 2.0 m (15 3/4 inches to
78 3/4 inches) (T)

[Input and Output connectors]

A/V OUT (MONO) (Monaural)

Minijack
Video: 1 Vp-p, 75 Ω unbalanced,
sync negative
Audio: 327 mV (at a 47 kΩ load)
Output impedance 2.2 kΩ

ACC jack

Mini-minijack (ø 2.5 mm)

USB jack

mini-B

[LCD screen]

LCD panel

3.8 cm (1.5 type) TFT drive

Total number of dots

123 200 (560×220) dots

[General]

Used battery pack

NP-FC11

Power requirements

3.6 V

Power consumption (during shooting with LCD screen on)

1.7 W

Operating temperature

0°C to 40°C (32°F to 104°F)

Storage temperature

–20°C to +60°C (–4°F to +140°F)

Dimensions

99.5×65.2×56.8 mm
(4×2 5/8×2 1/4 inches)
(W/H/D, excluding maximum
protrusions)

Mass

Approx. 300 g (10.6 oz) (including
battery pack NP-FC11, “Memory
Stick”, and hand strap)

Built-in microphone

Electret condenser microphone

Built-in speaker

Dynamic speaker

Exif Print Compatible

PRINT Image Matching II Compatible

■ AC-LS5 AC Adaptor

Power requirements

100 to 240 V AC, 50/60 Hz

Current consumption

0.16 to 0.09 A

Power consumption

11 W

Rated output voltage

4.2 V DC, 1.5 A

Operating temperature

0°C to 40°C (32°F to 104°F)

Storage temperature

-20°C to +60°C (-4°F to +140°F)

Dimensions (approx.)

48×29×81 mm

(1 15/16×1 3/16×3 1/4 inches)

(W/H/D) excluding projecting parts

Mass (approx.)

130 g (5 oz) excluding power cord
(mains lead)

■ NP-FC11 battery pack

Used battery

Lithium-ion battery

Maximum voltage

DC 4.2 V

Nominal voltage

DC 3.6 V

Capacity

 2.8 Wh (780 mAh)

■ Accessories

- AC Adaptor (1)
- Power cord (mains lead) (1)
- USB cable (1)
- NP-FC11 battery pack (1)
- A/V connecting cable (1)
- Hand strap (1)
- “Memory Stick” (32 MB) (1)
- CD-ROM (USB driver SPVD-010) (1)
- Operating instructions (1)

Design and specifications are subject to change without notice.

The LCD screen

When shooting still images

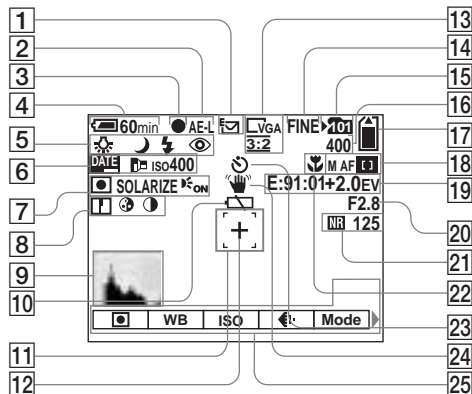

- 1 Recording mode indicator (58-62)
- 2 AE LOCK indicator (52)
- 3 AE/AF lock indicator (21)
- 4 Battery remaining indicator (11)
- 5 White balance indicator (55)/
Mode dial indicator/
Flash mode indicator (26)/
Red-eye reduction indicator (26)
- 6 Date/time indicator (29)/
Conversion lens indicator (67)/
ISO number indicator (111)

- 7 Metering mode indicator (51)/
Picture effect indicator (65)/
Hologram AF indicator (27)
- 8 Sharpness indicator (112)/
Saturation indicator (112)/
Contrast indicator (112)
- 9 Histogram indicator (50)
- 10 Low battery warning indicator
(107)
- 11 AF range finder frame (46)
- 12 Spot metering cross hair (52)
- 13 Image size indicator (18)
- 14 Image quality indicator (41)

- 15 Recording folder indicator (41)
- 16 Remaining number of recordable
images indicator (19)
- 17 Remaining “Memory Stick”
capacity indicator
- 18 AF mode (47)/AF range finder
frame indicator (46)/Focus
preset value (48)
- 19 Self-diagnosis display (108)/EV
level indicator (49)
- 20 Aperture value indicator (43)
- 21 NR slow shutter indicator (44)/
Shutter speed indicator (43)
- 22 Macro indicator (24)
- 23 Self-timer indicator (25)
- 24 Vibration warning indicator
- 25 Menu/Guide menu (39)/Jog dial
(40)

- Pressing MENU switches the menu on/off.

Page numbers in parentheses indicate the location of additional important information.

When shooting movies

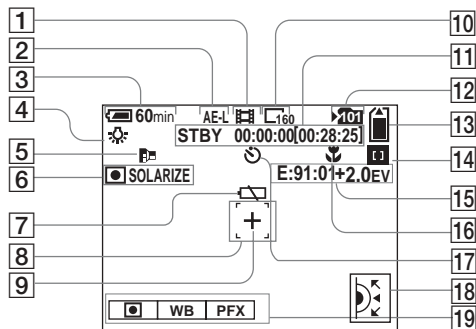

- | | |
|--|--|
| 1 Recording mode indicator (79) | 12 Recording folder indicator (41) |
| 2 AE LOCK indicator (52) | 13 Remaining "Memory Stick" capacity indicator |
| 3 Battery remaining indicator (11) | 14 AF range finder frame indicator (46)/Focus preset value (48) |
| 4 White balance indicator (55) | 15 Self-diagnosis display (108)/EV level indicator (49) |
| 5 Conversion lens indicator (67) | 16 Macro indicator (24) |
| 6 Metering mode indicator (51)/ Picture effect indicator (65) | 17 Self-timer indicator (25) |
| 7 Low battery warning indicator (107) | 18 Jog dial (40) |
| 8 AF range finder frame (46) | 19 Menu/Guide menu (39) |
| 9 Spot metering cross hair (52) | |
| 10 Image size indicator (79) | |
| 11 Recording time [maximum recordable time] indicator | |

- Pressing MENU switches the menu on/off.

Page numbers in parentheses indicate the location of additional important information.

When playing back still images

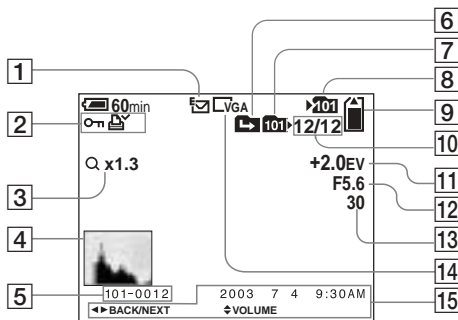

- | | |
|---|---|
| 1 Recording mode indicator (58-62) | 12 Aperture value indicator (43) |
| 2 Protect indicator (74)/
Print (DPOF) mark indicator (76)/
Volume indicator (62) | 13 Shutter speed indicator (43) |
| 3 Zoom scaling indicator (69)/
Jog playback indicator (73) | 14 Image size indicator (18) |
| 4 Histogram indicator (50) | 15 Recording date of the playback
image (29)/Menu/Guide menu
(39) |
| 5 Folder-file number | |
| 6 Change folder indicator | |
| 7 Playback folder indicator (68) | |
| 8 Recording folder indicator (41) | |
| 9 Remaining "Memory Stick"
capacity indicator | |
| 10 Image number/Number of
images recorded in selected
folder | |
| 11 EV level indicator (49) | |

Page numbers in parentheses indicate the location of additional important information.

When playing back moving images

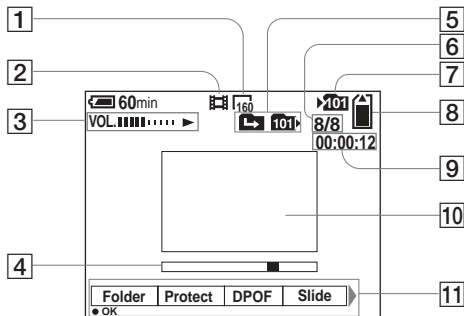

- | | | | |
|---|--|----|---|
| 1 | Image size indicator (79) | 6 | Image number/Number of images recorded in selected folder |
| 2 | Recording mode indicator (79) | 7 | Recording folder indicator (41) |
| 3 | Volume indicator (80)/Playback indicator (80) | 8 | Remaining "Memory Stick" capacity indicator |
| 4 | Playback bar (80) | 9 | Counter (80) |
| 5 | Change folder/
Playback folder indicator (68) | 10 | Playback image (80) |
| | | 11 | Menu/Guide menu (39) |

Page numbers in parentheses indicate the location of additional important information.

Index

A

AC Adaptor	10, 13
Access lamp	17
Advanced accessory shoe	66
AE LOCK	52
AE/AF lock	21, 22, 48
AF lock	48
AF Mode	47
AF range finder frame	45
Aperture priority mode	45
Auto adjustment mode	20
Auto Focus	22, 45
Auto power-off function	14
A/V connecting cable	32

B

Battery pack	
battery life	12, 121
charging	10, 120
charging time	11
remaining indicator	11, 121
Beep/shutter sound	117
Burst	60

C

CD-ROM	85
Center-weighted metering	51
Changing the recording folder	42

Charging

battery pack	10, 120
charging time	11
Cleaning	118
Clip Motion	58
Clock Set	15, 117
Contrast	112
Control button	9, 14, 39
Conversion lens	67
Copying images	90, 92, 96
Copying images to your	
computer	90, 91, 92, 96
Creating a new folder	42

D

DC plug	10, 13
Deleting images	34, 81
Divide	83
DPOF	76

E

E-mail	62
Enlarging an image	69
EV adjustment	49
Exposure Bracket	53
External flash	65
External power source	13

F

File	
file names	94
image file storage destinations	93

Finder	28
Flash	26
Flash Level	58
Focusing	
AF lock	48
auto focus method	22, 45
Continuous AF	47
focus preset	48
Monitoring AF	47
Multipoint AF	46
Selected frame priority AF	46
Single AF	47
Spot AF	46
Folder	41, 68
Format	37

G

GIF	58, 94
-----------	--------

H

Histogram	50
Hologram AF	27
Hot shoe	116

I

Image file storage destinations	93
Image quality	19
Image size	18, 19, 109
Image Transfer	90
ImageMixer	88
Index screen	31
“InfoLITHIUM” battery pack	120
ISO	111

J

Jog dial	40
Jog playback	73
JPG	94

L

LCD screen	
brightness	117
on/off	28
screen display	124, 125, 126, 127

M

Macro	24
Manual exposure mode	45
Memory Stick	17, 119
remaining indicator	124
Menu settings	39, 111
Metering mode	51
Mode dial	8, 15, 21
Moisture condensation	118
Movie	
cutting movies	83
deleting movies	81
shooting movies	79
viewing images on your computer	92, 96
viewing movies on the LCD screen	80
MPEG movie	79
MPG	79, 94
Multi Burst	60, 72
Multi-pattern metering	51

N

NightFraming	57
NightShot	56
NR slow shutter	44
NTSC system	33, 117
Number of images that can be saved or shooting time	12, 19, 109

P

PAL system	33, 117
Picture effect	65
Playback zoom	69
Power	
AC Adaptor	10, 13
battery pack	10
on/off	14
Power Save	12, 117
Precautions	118
Print (DPOF) mark	76
Program auto shooting mode	21
Program Shift	43
Protect	74

Q

Quick Review	22
--------------------	----

R

Red Eye Reduction	26
Remaining indicator	11
RESET button	97
Resize	76
Rotate	71

S

Saturation	112
Scene Selection	63
SCN	22, 63
Self-diagnosis display	108
Self-timer	25
Setting	
date and time	15, 117
image size	18, 19, 109
menu items	39, 111
SET UP items	39, 115
Sharpness	112
Shooting mode	
auto adjustment mode	20
Burst	60
Clip Motion	58
E-mail	62
Exposure Bracket	53
MPEG movie	79
Multi Burst	60, 72
TIFF	61, 94
Voice	62
Shutter speed priority mode	44
Single image screen	30
Slide show	70
Smart zoom	23
Spot metering	52
Still image	
deleting	34
shooting	20
viewing images on the LCD screen	30
viewing images on your computer	92
Superimposing the date and time	29, 115

T

TIFF	61, 94
Trimming	70
TV color system	33

U

USB	89, 95
USB driver	86, 95
Using your camera abroad	13

V

Viewing images on the LCD screen	30, 80
Viewing images on your computer	92
Voice	62

W

Warnings and messages	106
White Balance	55

Z

Zoom	23
Zoom lever	23, 116

308231111



Printed on 100% recycled paper
using VOC (Volatile Organic
Compound)-free vegetable oil
based ink.

<http://www.sony.net/>
Sony Corporation Printed in Japan

Additional information on this product and answers to frequently asked questions can be found at our Customer Support Website.