

# SONY®

3-074-351-13(1)

## Digital Still Camera

### Operating Instructions

Before operating the unit, please read this manual thoroughly, and retain it for future reference.

### Owner's Record

The model and serial numbers are located on the bottom. Record the serial number in the space provided below. Refer to these numbers whenever you call upon your Sony dealer regarding this product.

Model No. DSC-P71/P51/P31

Serial No. \_\_\_\_\_

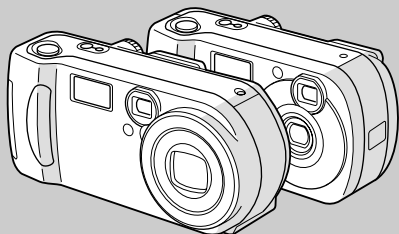

**Cyber-shot**  
Digital Still Camera



MEMORY STICK™

## DSC-P71/P51/P31

Getting started \_\_\_\_\_

Shooting still images \_\_\_\_\_

Viewing still images \_\_\_\_\_

Deleting still images \_\_\_\_\_

Copying still images to your computer \_\_\_\_\_

Before advanced operations \_\_\_\_\_

Advanced still image shooting \_\_\_\_\_

Advanced still image viewing \_\_\_\_\_

Still image editing \_\_\_\_\_

Enjoying movies \_\_\_\_\_

Troubleshooting \_\_\_\_\_

Additional information \_\_\_\_\_

Index

## WARNING

To prevent fire or shock hazard, do not expose the unit to rain or moisture.

## For the Customers in the U.S.A.

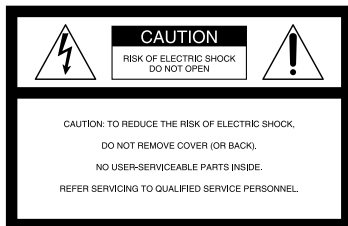

This symbol is intended to alert the user to the presence of uninsulated “dangerous voltage” within the product’s enclosure that may be of sufficient magnitude to constitute a risk of electric shock to persons.



This symbol is intended to alert the user to the presence of important operating and maintenance (servicing) instructions in the literature accompanying the appliance.

If you have any questions about this product, you may call:

Sony Customer Information Services Center  
1-800-222-SONY (7669)

The number below is for the FCC related matters only.

## Declaration of Conformity

Trade Name: SONY  
Model No.: DSC-P71  
Responsible Party: Sony Electronics Inc.  
Address: 680 Kinderkamack  
Road, Oradell, NJ  
07649 USA  
Telephone No.: 201-930-6972

This device complies with Part 15 of the FCC Rules. Operation is subject to the following two conditions: (1) This device may not cause harmful interference, and (2) this device must accept any interference received, including interference that may cause undesired operation.

## Declaration of Conformity

Trade Name: SONY  
Model No.: DSC-P51, DSC-P31  
Responsible Party: Sony Electronics Inc.  
Address: 680 Kinderkamack  
Road, Oradell, NJ  
07649 USA  
Telephone No.: 201-930-6972

This device complies with Part 15 of the FCC Rules. Operation is subject to the following two conditions: (1) This device may not cause harmful interference, and (2) this device must accept any interference received, including interference that may cause undesired operation.

## CAUTION

You are cautioned that any changes or modifications not expressly approved in this manual could void your authority to operate this equipment.

**Note:**

This equipment has been tested and found to comply with the limits for a Class B digital device, pursuant to Part 15 of the FCC Rules. These limits are designed to provide reasonable protection against harmful interference in a residential installation. This equipment generates, uses, and can radiate radio frequency energy and, if not installed and used in accordance with the instructions, may cause harmful interference to radio communications. However, there is no guarantee that interference will not occur in a particular installation. If this equipment does cause harmful interference to radio or television reception, which can be determined by turning the equipment off and on, the user is encouraged to try to correct the interference by one or more of the following measures:

- Reorient or relocate the receiving antenna.
- Increase the separation between the equipment and receiver.
- Connect the equipment into an outlet on a circuit different from that to which the receiver is connected.
- Consult the dealer or an experienced radio/TV technician for help.

The supplied interface cable must be used with the equipment in order to comply with the limits for a digital device pursuant to Subpart B of Part 15 of FCC Rules.

**For the Customers in the U.S.A. and Canada****RECYCLING NICKEL METAL HYDRIDE BATTERIES**

Nickel Metal Hydride batteries are recyclable.

You can help preserve our environment by returning your used rechargeable batteries to the collection and recycling location nearest you.



For more information regarding recycling of rechargeable batteries, call toll free 1-800-822-8837, or visit <http://www.rbr.org/>

**Caution:** Do not handle damaged or leaking Nickel Metal Hydride batteries.

**CAUTION**

TO PREVENT ELECTRIC SHOCK, DO NOT USE THIS POLARIZED AC PLUG WITH AN EXTENSION CORD, RECEPTACLE OR OTHER OUTLET UNLESS THE BLADES CAN BE FULLY INSERTED TO PREVENT BLADE EXPOSURE.

**NOTICE FOR THE CUSTOMERS IN THE UNITED KINGDOM**

A moulded plug complying with BS 1363 is fitted to this equipment for your safety and convenience.

Should the fuse in the plug supplied need to be replaced, a 5 AMP fuse approved by ASTA or BSI to BS 1362, (i.e. marked with ♡ or ⬠ mark) must be used.

If the plug supplied with this equipment has a detachable fuse cover, be sure to attach the fuse cover after you change the fuse. Never use the plug without the fuse cover. If you should lose the fuse cover, please contact your nearest Sony service station.

**For the Customers in Germany**

Directive: EMC Directive 89/336/EEC, 92/31/EEC

This equipment complies with the EMC regulations when used under the following circumstances:

- Residential area
- Business district
- Light-industry district

(This equipment complies with the EMC standard regulations EN55022 Class B.)

## Attention for the Customers in Europe

This product has been tested and found compliant with the limits sets out on the EMC Directive for using connection cables shorter than 3 meters.

## Attention

The electromagnetic fields at the specific frequencies may influence the picture and sound of this camera.

## “Memory Stick”





## For the Customers in the U.S.A. and Canada

THIS CLASS B DIGITAL DEVICE COMPLIES WITH PART 15 OF THE FCC RULES AND THE CANADIAN ICES-003 OPERATION IS SUBJECT TO THE FOLLOWING TWO CONDITIONS:  
(1) THIS DEVICE MAY NOT CAUSE HARMFUL INTERFERENCE, AND  
(2) THIS DEVICE MUST ACCEPT ANY INTERFERENCE RECEIVED, INCLUDING INTERFERENCE THAT MAY CAUSE UNDESIRED OPERATION.

## Notice

If static electricity or electromagnetism causes data transfer to discontinue midway (fail), restart the application or disconnect and connect the USB cable again.

## Trademarks

- “Memory Stick,”  “MagicGate Memory Stick,” and  are trademarks of Sony Corporation.
- “MagicGate” and **MAGICGATE** are trademarks of Sony Corporation.
- Microsoft and Windows are registered trademarks of the U.S. Microsoft Corporation in the United States and other countries.
- Macintosh, Mac OS, and QuickTime, are trademarks or registered trademarks of Apple Computer, Inc.
- In addition, system and product names used in this manual are, in general, trademarks or registered trademarks of their respective developers or manufacturers. However, the ™ or ® marks are not used in all cases in this manual.

# Before using your camera

## **Trial recording**

Before you record one-time events, you may want to make a trial recording to make sure that the camera is working correctly.

## **No compensation for contents of the recording**

Contents of the recording cannot be compensated for if recording or playback is not possible due to a malfunction of your camera or recording medium, etc.

## **Notes on image data compatibility**

- This camera conforms with the Design Rules for Camera File Systems universal standard established by the JEITA (Japan Electronics and Information Technology Industries Association).
- Playback of images recorded with your camera on other equipment and playback of images recorded or edited with other equipment on your camera are not guaranteed.

## **Precaution on copyright**

Television programs, films, video tapes, and other materials may be copyrighted. Unauthorized recording of such materials may be contrary to the provision of the copyright laws.

## **Do not shake or strike the camera**

In addition to malfunctions and inability to record images, this may render the “Memory Stick” unusable or image data breakdown, damage or loss may occur.

## **LCD screen, LCD finder (only models with a LCD finder) and lens**

- The LCD screen and the LCD finder are manufactured using extremely high-precision technology so over 99.99% of the pixels are operational for effective use. However, there may be some tiny black points and/or bright points (white, red, blue or green in color) that constantly appear on the LCD screen and the LCD finder. These points are normal in the manufacturing process and do not affect the recording in any way.
- Be careful when placing the camera near a window or outdoors. Exposing the LCD screen, the finder or the lens to direct sunlight for long periods may cause malfunctions.

## **Do not get the camera wet**

When taking pictures outdoors in the rain or under similar conditions, be careful not to get the camera wet. If moisture condensation occurs, see page 99 and follow the instructions on how to remove it before using the camera.

## **The auto zoom lens (for the DSC-P71 only)**

This camera is equipped with an auto zoom lens. Be careful not to bump the lens, and be careful not to apply force to it.

## **On illustrations**

Illustrations used in this manual are of the DSC-P71 unless noted otherwise.

## **The pictures used in this manual**

The photographs used as examples of pictures in this manual are reproduced images, and are not actual images shot using this camera.

## **Do not aim the camera at the sun or other bright light**

This may cause irrecoverable damage to your eyes.

## **Back up recommendation**

To avoid the potential risk of data loss, always copy (back up) data to a disk.

# Table of contents

Before using your camera .....	5
Identifying the parts .....	8

## Getting started

Preparing batteries .....	14
Charging the batteries .....	14
Inserting the batteries .....	17
Using an external power source .....	19
Using your camera abroad .....	19
Turning on/off your camera .....	20
How to use the control button .....	20
Setting the date and time .....	21

## Shooting still images

Inserting and removing a “Memory Stick” .....	23
Deciding the still image size and quality	24
Basic still image shooting (using auto adjustment mode) .....	26
Checking the last shot image (Quick Review) .....	27
Using the zoom feature .....	28
Shooting close-ups (Macro) (DSC-P71 only) .....	28
Using the self-timer .....	29
Selecting a flash mode .....	30
Shooting with the finder .....	32
Shooting with the date and time inserted .....	32

Shooting according to scene conditions (SCENE SELECTION) .....	34
---	----

## Viewing still images

Viewing images on the LCD screen of your camera .....	36
Viewing single images .....	36
Viewing Index (nine- or triple- image display) .....	37
Viewing images on a TV screen .....	38

## Deleting still images

Deleting images .....	39
Deleting on the Index (nine-image) screen .....	40
Deleting on the Index (triple-image) screen .....	41
Formatting a “Memory Stick” .....	43

## Copying still images to your computer

Copying still images to your computer ...	44
① Installing the USB driver .....	45
② Preparing your camera .....	46
③ Connecting your camera to your computer .....	47
④ Copying images .....	48
When a removable disk icon is not shown .....	49
Copying images (for Windows XP users) .....	49
Image file storage destinations and file names .....	51
⑤ Viewing the images on your computer .....	53
For Macintosh users .....	54

## Before advanced operations

How to setup and operate your camera...	55
Changing menu settings.....	55
Changing items in the SET UP screen.....	55

## Advanced still image shooting

Adjusting the exposure (EV adjustment)	56
Adjusting color tones (WHITE BALANCE).....	57
Choosing a focus method (MULTI AF/CENTER AF).....	58
Setting the distance to the subject (Focus preset).....	60
Adding special effects (P. EFFECT).....	60
Spot light-metering.....	61
Shooting multiple frames (CLIP MOTION).....	62
Shooting in Multi Burst mode (MULTI BURST).....	64
Shooting still images for e-mail (E-MAIL).....	65

## Advanced still image viewing

Enlarging a portion of a still image .....	66
Enlarging an image – Playback zoom	66
Recording an enlarged image – Trimming.....	67
Playing back successive images (SLIDE SHOW).....	67
Rotating still images (ROTATE).....	68

## Still image editing

Protecting images (PROTECT).....	69
For single images.....	69
For Index (nine-image) screen.....	69
For Index (triple-image) screen.....	70
Changing image size (RESIZE).....	71
Choosing images to print (PRINT).....	72
For single images.....	72
For index (nine-images) screen .....	72
For index (triple-image) screen .....	73

## Enjoying movies

Shooting movies .....	74
Viewing movies on the LCD screen .....	75
Deleting movies .....	76
Deleting on the single screen.....	76
Deleting on the Index (nine-image) screen.....	76

Deleting on the Index (triple-image) screen .....	77
Editing movies.....	78
Cutting movies .....	78
Deleting unnecessary portions of a movie .....	79
Copying movies to your computer .....	80
For Windows 98, 98SE, 2000, Me users .....	80
For Windows XP users .....	80
For Macintosh users .....	81

## Troubleshooting

Troubleshooting .....	82
Warnings and messages .....	89
Self-Diagnostics Display.....	90

## Additional information

The number of images that can be saved/ shooting time.....	91
Menu items .....	92
SET UP items .....	97
Precautions .....	99
The “Memory Stick” .....	100
The nickel hydride batteries .....	100
Specifications .....	101
The LCD screen .....	103
Index.....	106

# Identifying the parts (DSC-P71)

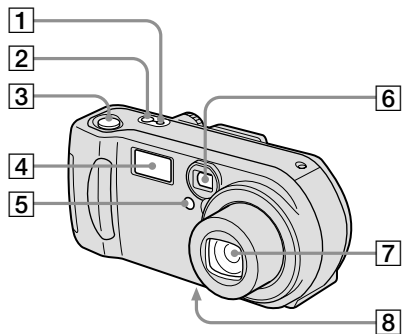
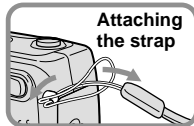

- 1 POWER ON/OFF lamp** (20)
- 2 POWER button** (20)
- 3 Shutter button** (26)
- 4 Flash** (30)
- 5 Self-timer lamp** (29)/  
**AF illuminator** (31, 97)
- 6 Finder window**
- 7 Lens**
- 8 Tripod receptacle (bottom surface)**

- Use a tripod with a screw length of less than 5.5mm (7/32 inch). You will be unable to firmly secure the camera to tripods having longer screws, and may damage the camera.



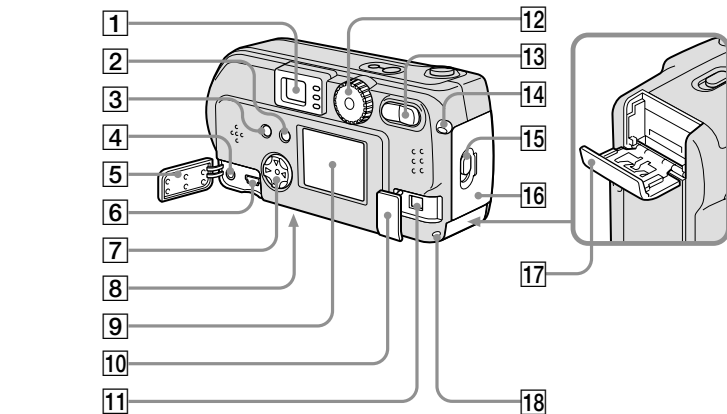

**1 Finder**

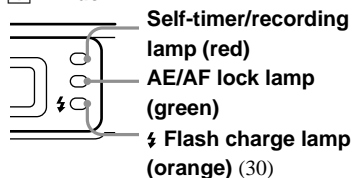

**2 DISPLAY/LCD ON/OFF button**  
 (32)

**3 MENU button** (24)

**4 VIDEO OUT jack** (38)

**5 Jack cover**

**6 USB jack** (47)

**7 Control button**

(Menu on) (▲/▼/◀/▶/●) (20)/  
 (Menu off) (⚡/🔄/📷/👤) (27, 29, 30)

**8 RESET button (bottom surface)**  
 (82)

**9 LCD screen**

**10 DC IN jack cover** (19)

**11 DC IN jack** (19)

**12 Mode dial** (21)

📷: To shoot still images

▶: To view or edit images

🎥: To shoot movies /Clip Motion images/Multi Burst mode images

SET UP: To set the SET UP items  
 SCN: To shoot in the SCENE SELECTION mode

**13 Zoom button (for shooting) (28)/  
 Index button (for viewing) (37)**

**14 Wrist strap hook**

**15 Open lever**

**16 Battery cover**

**17 "Memory Stick" cover**

**18 Access lamp** (23)

## Identifying the parts (continued) (DSC-P51)

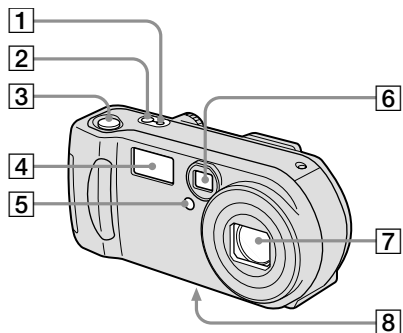
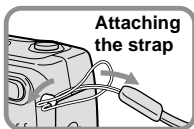

- 1** POWER ON/OFF lamp (20)
- 2** POWER button (20)
- 3** Shutter button (26)
- 4** Flash (30)
- 5** Self-timer lamp (29)/  
AF illuminator (31, 97)
- 6** Finder window
- 7** Lens
- 8** Tripod receptacle (bottom  
surface)

- Use a tripod with a screw length of less than 5.5mm (7/32 inch). You will be unable to firmly secure the camera to tripods having longer screws, and may damage the camera.

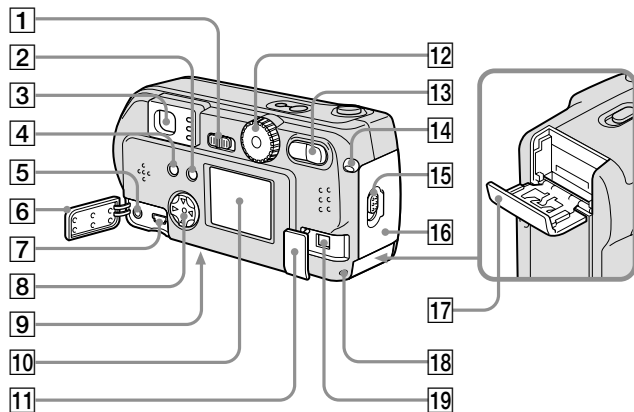

- 1 POWER SAVE switch
- 2 DISPLAY/LCD ON/OFF button (32)

3 Finder

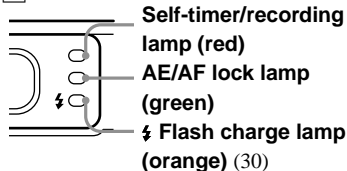

- 4 MENU button (24)
- 5 VIDEO OUT jack (38)
- 6 Jack cover
- 7 USB jack (47)

- 8 Control button  
(Menu on) (▲/▼/◀/▶/●) (20)/  
(Menu off) (⚡/📷/📺/●) (27, 29, 30, 61)
- 9 RESET button (bottom surface) (82)
- 10 LCD screen
- 11 DC IN jack cover (19)

- 12 Mode dial (21)
  - 📷: To shoot still images
  - ▶: To view or edit images
  - 📺: To shoot movies /Clip Motion images/Multi Burst mode images
  - SET UP: To set the SET UP items
  - SCN: To shoot in the SCENE SELECTION mode
- 13 Zoom button (for shooting) (28)/ Index button (for viewing) (37)
- 14 Wrist strap hook
- 15 Open lever
- 16 Battery cover
- 17 "Memory Stick" cover
- 18 Access lamp (23)
- 19 DC IN jack (19)

## Identifying the parts (continued) (DSC-P31)

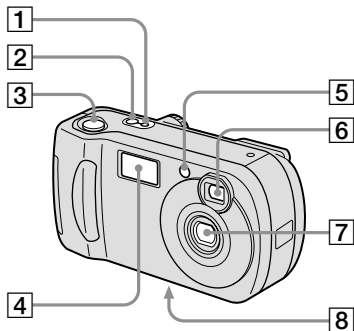
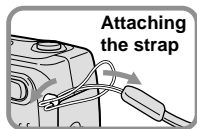

- 1 POWER ON/OFF lamp** (20)
- 2 POWER button** (20)
- 3 Shutter button** (26)
- 4 Flash** (30)
- 5 Self-timer lamp** (29)/  
**AF illuminator** (31, 97)
- 6 Finder window**
- 7 Lens**
- 8 Tripod receptacle (bottom surface)**

- Use a tripod with a screw length of less than 5.5mm (7/32 inch). You will be unable to firmly secure the camera to tripods having longer screws, and may damage the camera.

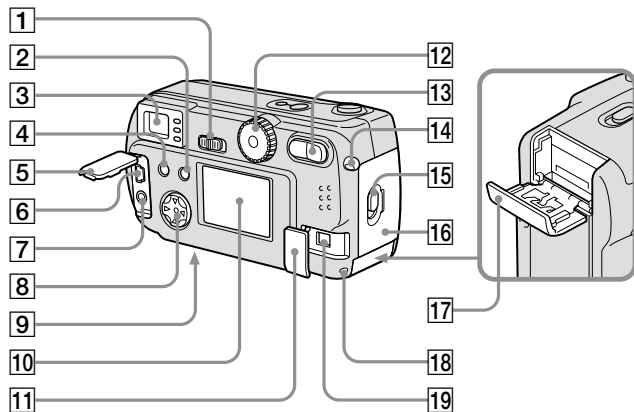

- 1 POWER SAVE switch
- 2 DISPLAY/LCD ON/OFF button (32)

3 Finder

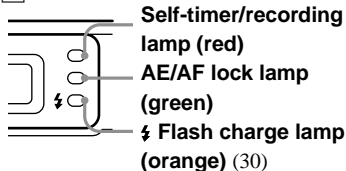

- 4 MENU button (24)
- 5 Jack cover
- 6 USB jack (47)
- 7 VIDEO OUT jack (38)

- 8 Control button  
(Menu on) (▲/▼/◀/▶/●) (20)/  
(Menu off) (⚡/📷/📺/●) (27, 29, 30, 61)
- 9 RESET button (bottom surface) (82)
- 10 LCD screen
- 11 DC IN jack cover (19)

- 12 Mode dial (21)
  - 📷: To shoot still images
  - ▶: To view or edit images
  - 🎥: To shoot movies /Clip Motion images/Multi Burst mode images
  - SET UP: To set the SET UP items
  - SCN: To shoot in the SCENE SELECTION mode
- 13 Zoom button (for shooting) (28)/ Index button (for viewing) (37)
- 14 Wrist strap hook
- 15 Open lever
- 16 Battery cover
- 17 “Memory Stick” cover
- 18 Access lamp (23)
- 19 DC IN jack (19)

## Preparing batteries

Use the following batteries in this camera.

### Acceptable batteries

R6 (size AA) Nickel-Metal Hydride batteries (2)

- NH-AA-DI (2) (supplied)
- NH-AA-2DI twin-pack (recommended, not supplied)

### Batteries that cannot be used

Manganese batteries, lithium batteries, nickel cad batteries, alkaline batteries (cannot be used with the DSC-P71)

\* Use of AA alkaline batteries may result in shorter than desired operating time. (only in the DSC-P51/P31)

When alkaline batteries are used, take note of the following information.

- Turn POWER SAVE to ON, shut the LCD screen off, and use the Finder to shoot your images. This will lengthen battery life (page 16).
- There is a big difference in the performance of batteries of different types and of batteries made by different manufacturers. This is especially true in low temperatures, where some batteries are noticeably weaker. You may not be able to shoot in temperatures below +5°C (41°F).
- The battery remaining indicator may not display the correct information.

## Charging the batteries

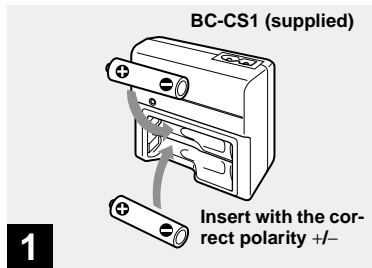

➔ **Insert Nickel-Metal Hydride batteries into the charger (supplied).**

- Be sure to charge the Nickel-Metal Hydride batteries supplied with your camera before using them.
- Be sure to charge the batteries in an environment where the ambient temperature is 10°C to 30°C (50°F to 86°F). If the batteries are charged in an environment where the temperature is outside that range, the batteries may not charge efficiently.
- Connect the battery charger to an easily accessible wall outlet (mains) close by. If something goes wrong while you are using the charger, immediately shut off the power by pulling the plug out of the wall outlet.

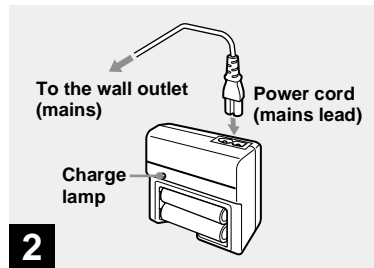

➔ **Connect the charger to a wall outlet (mains) using the power cord (mains lead).**

Charging starts, and the charge lamp lights. When the charge lamp goes out, charging is finished.

- When charging is finished, disconnect the power cord (mains lead) from the wall outlet (mains), and remove the Nickel-Metal Hydride batteries from the charger.
- When transporting the Nickel-Metal Hydride batteries, be sure to use the battery case (supplied). If the +/- metal terminals are shorted, there is a possibility of danger from excessive heat or fire.

## Charging the Nickel-Metal Hydride batteries

- If the poles of the Nickel-Metal Hydride batteries are dirty, the batteries may not charge properly. Occasionally clean the poles of the batteries and the terminals of the charger by wiping them with a dry cloth.
- At the time of purchase, or when the Nickel-Metal Hydride batteries haven't been used for a long time, they may not fully charge. This is typical of this type of battery, and is not a malfunction. If this happens, repeatedly using up the battery fully, and then recharging it, should correct the problem.
- Even when Nickel-Metal Hydride batteries are not being used they lose their charge naturally over time. It is recommended that you recharge the batteries just before using them.
- If you recharge Nickel-Metal Hydride batteries before fully using up the existing charge, the so-called memory effect\* can occur, and the low battery warning will be triggered sooner than expected. Charging the battery after fully depleting the existing charge should correct the problem.
  - \* The "memory effect" – the situation in which a battery temporarily accepts a less than full charge.
- To use up the batteries completely, put the camera in the slide show mode and leave it that way until the batteries are used up (page 67).

## Precautions to be observed when charging the batteries

- Do not charge any other batteries except Sony Nickel-Metal Hydride batteries in the charger supplied with your camera. If you try to charge any other type of battery (e.g., manganese batteries, alkaline dry cells, or one-time lithium batteries) than the batteries specified, those batteries may leak, overheat, or explode, causing the danger of burns or other injuries.
- Be sure to charge both Nickel-Metal Hydride batteries at the same time.
- When the batteries are charged, use them only in an environment where the temperature range is 0°C to 40°C (32°F to 104°F). Otherwise, there is a danger of leaks, explosions, excessive heat, fire, or electric shock.
- Do not charge fully charged Nickel Metal Hydride batteries again. Otherwise, there is a danger of leaks, explosions, excessive heat, fire, or electric shock.
- Do not peel off the external seals or damage the batteries. Never use batteries from which the seals have been partially or completely removed, or batteries that have been split in any way.

## Charging time



Nickel-Metal Hydride battery	Charging time
NH-AA-DI × 2 (supplied)	Approx. 13 hours

This represents the time required to charge fully depleted Nickel-Metal Hydride batteries using the supplied BC-CS1 charger in an environment where the ambient temperature is 25°C (77°F).

- Charging is complete in approximately 13 hours. The charge lamp may remain lit longer than 13 hours, but this is not a malfunction.
- If you use the ACC-CSNQ STAMINA "Super Quick charge" kit (not supplied), the batteries will charge faster.

## Battery remaining indicator

As the battery power decreases with use, the Battery remaining indicator displays the amount of power remaining using the following symbols.

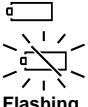
Battery remaining indicator	Battery remaining guidelines (A full charge is 100%)
	Sufficient power remaining
	Battery half full
	Battery low, recording/playback will stop soon.
	Change the batteries for fully charged ones, or charge these batteries.

- If the LCD screen is off, press the DISPLAY/LCD ON/OFF button to turn it on.
- Based on the conditions under which the camera is being used and the state of the charge, or on the environment, this information may not be correctly indicated.
- When the AC adaptor is being used, the Remaining battery information is not displayed.

## The POWER SAVE function

When the POWER SAVE function is set to ON, you can shoot for a longer period of time.

### DSC-P71



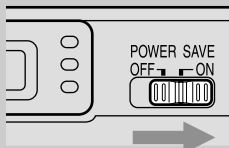

Turn the Mode dial to SET UP, and set [POWER SAVE] in SETUP 2 to [ON]. The factory setting of the camera is set to [ON] (page 98).

### DSC-P51/P31

Set the POWER SAVE switch to ON. When the camera is shipped from the factory, this switch is set to ON.



## When the POWER SAVE function is ON

- The LCD screen will be darker than it is when POWER SAVE is set to OFF. You cannot change the settings for [LCD BACKLIGHT] at this time (page 98). To make the available shooting time even longer, it is recommended that you turn off the LCD screen and use the Finder to do your shooting (page 32).
- In Flash mode, the  (No flash) is displayed. If you want to shoot using the flash, press  on the control button, and select  (forced flash) or Auto (page 30).
- When the power turns on, the Flash mode is normally set to .
- When the flash is charging ( the Flash charge lamp blinks), the LCD screen turns off.
- In shooting still images, the focus only focuses when the shutter is pushed down halfway.



## Inserting the batteries

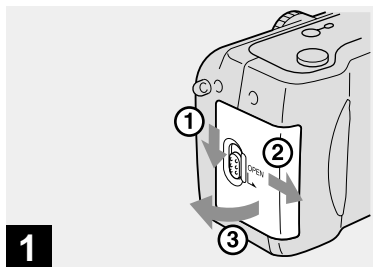

### → Open the Battery cover.

Slide it in the direction of the arrow, and it opens out.

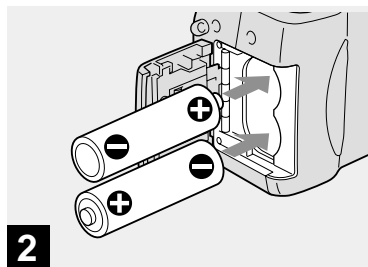

### → Insert the batteries.

Match the +/- poles of the batteries to the +/- marks inside the battery case.

- Occasionally clean the poles of the batteries and the terminals of the Battery cover by wiping them with a dry cloth. If the poles of the batteries or the terminals become covered with a film of dirt or oil from the skin, the operating time of the camera can be greatly reduced.

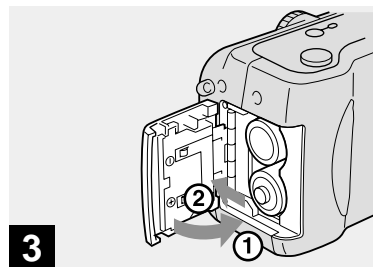

### → Close the Battery cover.

Close the Battery cover while holding the batteries in. The cover is closed when it clicks.

### To remove the batteries

Stand the camera on end, open the Battery cover upward, then remove the batteries.

- Make sure you don't drop the batteries when opening or closing the Battery cover.

### Battery life and the number of images that can be recorded/played back

The tables show approximate guidelines for the length of time the camera can be used when picture quality is set to Standard, when you shoot in Flash mode (🔦), and when you shoot in Normal mode (📷), and when you shoot in the ambient temperature is 25°C (77°F), and the supplied Nickel-Metal Hydride batteries are fully charged. The guidelines for the number of images that can be recorded or played back allow for changing the “Memory Stick” as necessary. Actual results may differ slightly from these, depending on the conditions of use.

### Shooting\* still images

Model	Image size	LCD screen	R6 (size AA) Ni-MH (2) (supplied)	
			Battery life (min.)	No. of images
DSC-P71	2048×1536 640×480	ON	Approx. 100	Approx. 2000
		OFF	Approx. 120	Approx. 2400
DSC-P51	1600×1200 640×480	ON	Approx. 150	Approx. 3000
		OFF	Approx. 180	Approx. 3600
DSC-P31	1600×1200 640×480	ON	Approx. 120	Approx. 2400
		OFF	Approx. 150	Approx. 3000

\* Recording one image approximately every three seconds

### Playing back\*\* still images

Model	Image size	R6 (size AA) Ni-MH (2) (supplied)	
		Battery life (min.)	No. of images
DSC-P71	2048×1536 640×480	Approx. 230	Approx. 4600
DSC-P51	1600×1200 640×480	Approx. 280	Approx. 5600
DSC-P31	1600×1200 640×480	Approx. 280	Approx. 5600

\*\*With the LCD screen on, showing single images in order, one approximately every three seconds

### Shooting\*\*\* movies images

Model	LCD screen	R6 (size AA) Ni-MH (2) (supplied)
DSC-P71	ON	Approx. 120
	OFF	Approx. 170
DSC-P51	ON	Approx. 150
	OFF	Approx. 200
DSC-P31	ON	Approx. 150
	OFF	Approx. 200

\*\*\* Continuous recording with a picture size of 160×112

## Using an external power source

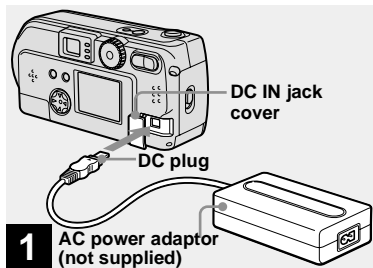

- 1** AC power adaptor (not supplied)
- Open the DC IN jack cover, then connect the AC-LS1 AC power adaptor (not supplied) to the DC IN jack of the camera.

Connect the cable with the ▲ mark facing up.

- Connect the AC power adaptor to an easily accessible wall outlet (mains) close by. If something goes wrong while you are using the adaptor, immediately shut off the power by pulling the plug out of the wall outlet.

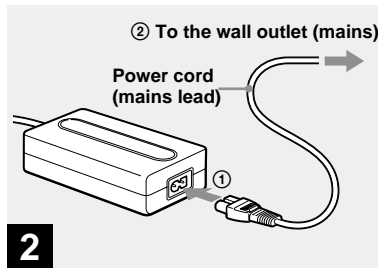

- 2** Connect the power cord (mains lead) to the AC power adaptor and to the wall outlet (mains).

- When you have finished using the AC power adaptor, disconnect it from the DC IN jack of the camera.
- To use power from an automobile, use a DC adaptor/Charger (not supplied).
- If you insert or remove the DC plug while you are using the batteries, the power may shut off.

## Using your camera abroad

### Power sources

You can use your camera in any country or area with the supplied battery charger or the AC-LS1 AC power adaptor (not supplied) within 100 V to 240 V AC, 50/60 Hz. Use a commercially available AC plug adaptor [a], if necessary, depending on the design of the wall outlet (wall socket) [b].

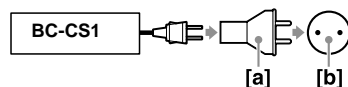

- Do not use an electronic transformer. Using this may cause a malfunction.

## Turning on/off your camera

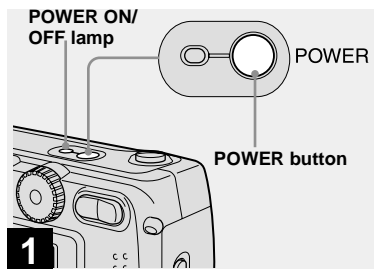

### ➔ Press the **POWER** button.

The POWER ON/OFF lamp lights in green, the power is on. When you turn on your camera for the first time, the CLOCK SET screen appears (see the next page).

### To turn off the power

If you press the POWER button again, the POWER ON/OFF lamp goes out, and the camera turns off.

- When the mode dial is set to , , , SCN and you turn the power on, the lens begins to move (DSC-P71 only). Please be careful not to touch the lens.

## The Auto Power Off function

If no tasks are performed for a while\* when shooting, viewing, or performing SET UP while using the batteries, power is automatically shut off to preserve battery power.

However, in the following circumstances, even if the battery is being used to power the camera, the Auto Power Off feature will not work.

- Movies are being played back
- A slide show is being shown
- There is a plug in the USB terminal or the VIDEO OUT jack

\* When POWER SAVE is set to ON:  
approximately 90 seconds  
When POWER SAVE is set to OFF:  
approximately 3 minutes

## How to use the control button

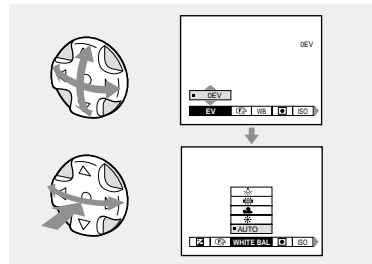



To change the current settings of the camera, bring up the menu or SET UP on the LCD screen (page 55), and use the control button to make the changes. For each item, press / / / to select the desired value, then press the center or / to make the setting.

- (SPOT METER) is not displayed on the menu of the DSC-P51/P31 (page 61).

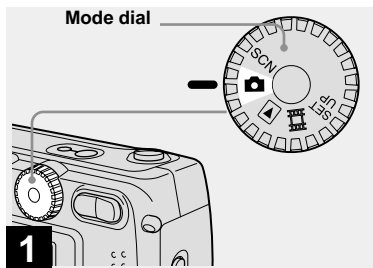
# Setting the date and time



➔ Set the mode dial to .

- To change values for the time and the date that have been previously set, change the mode dial to SET UP, choose [CLOCK SET] in SETUP 1 (page 97), then proceed from Step 3.
- You can also carry out this operation when the mode dial is set to SCN, , or .

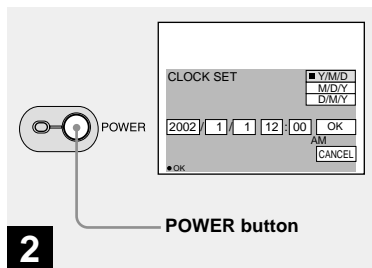

➔ Press the **POWER** button.

The POWER lamp lights in green and the CLOCK SET screen appears.

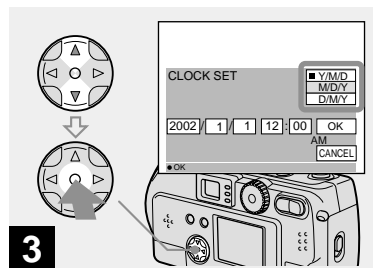

➔ Choose the desired order for the date, the month and the year using **▲/▼** on the control button, then push the center **●**.

You can choose from [Y/M/D] (year/month/day), [M/D/Y], and [D/M/Y].

- If the rechargeable button battery, which provides the power for saving the time data, ever loses its charge (page 99), the CLOCK SET screen automatically reappears. If this happens, reset the date and time by following the above procedure, starting from Step 3.

## Setting the date and time (continued)

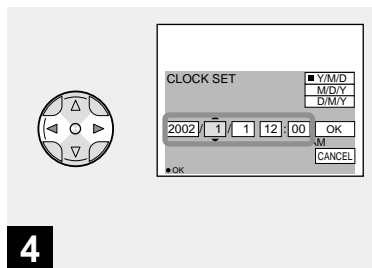

**4** → Choose the year, month, day, hour, and minute items using ◀▶.

A ▲ will be shown above, and a ▼ will be shown below the item currently selected to be set.

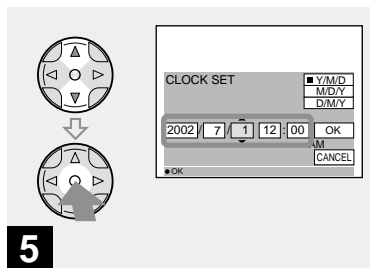

**5** → Set the desired numerical value using ▲/▼ on the control button, then press the center ●.

After setting the current numerical value, move to the next item. Repeat the above process until all of the items have been set.

- If you choose [D/M/Y] in Step **3**, use the 24 hour clock display.

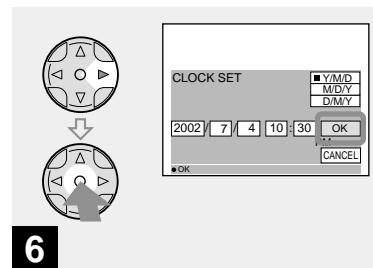

**6** → Choose [OK] using the ► on the control button, and then press the center ●.

After the date and time are set, the clock will start to keep time.

- To cancel the setting process, choose [CANCEL], and press the center ●.

# Inserting and removing a "Memory Stick"

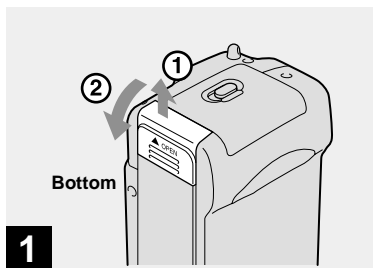

**1** → Open the "Memory Stick" cover.

Slide the cover in the direction of the arrow to open it.

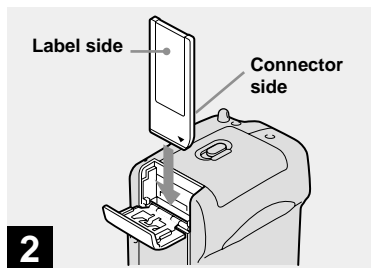

**2** → Insert the "Memory Stick."

Insert the "Memory Stick" all the way in until it clicks, as shown in the illustration.

- Whenever you insert a "Memory Stick," push it all the way in until it clicks. If you do not insert it correctly, a message such as "MEMORY STICK ERROR" appears on the LCD screen.

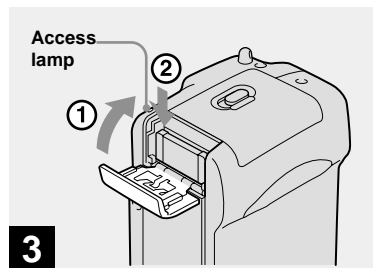

**3** → Close the "Memory Stick" cover.

**To remove the "Memory Stick"**

Open the "Memory Stick" cover, then push the "Memory Stick" to pop it out.

- Whenever the Access lamp is lit, the camera is recording or reading out an image. Never remove the "Memory Stick" or turn off the power at this time.

# Deciding the still image size and quality

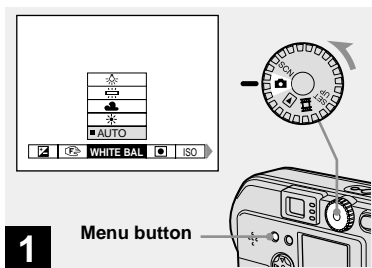



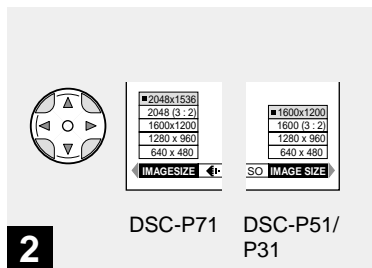

➔ Set the mode dial to , turn on the power, and then push the MENU button.

The menu appears.





- You can also carry out this operation when the mode dial is set to SCN.
-  (SPOT METER) is not displayed on the menu of the DSC-P51/P31 (page 61).

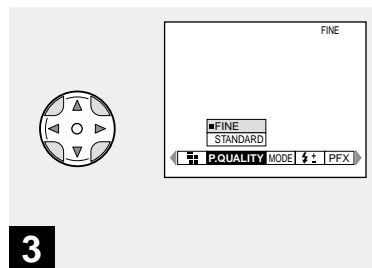

➔ Select  (Image size) using  on the control button. Use  /  to select the desired image size.

The image size is set.



➔ Select  (Image quality) using  on the control button. Use  /  to select the desired image quality.

The image quality is set.

When the setting is completed, press the MENU button. The menu disappears from the screen.

- For image quality, you can choose either [FINE] or [STANDARD].
- The image size and quality values chosen here will be preserved even when the camera is turned off.



## Image size and quality

You can choose image size (number of pixels) and image quality (compression ratio) based on the kind of images you want to shoot. The larger you make the image size and the higher you make the image quality, the better your image, but also the larger the amount of data needed to preserve your image. This means you can save fewer images in your “Memory Stick.”

Choose an image size and quality level appropriate for the kind of images you want to shoot.

You can resize the images later (Resize function, see page 71).

You can choose image size from the following tables.

Image size	Examples
2048×1536 (DSC-P71)	Very fine prints
2048(3:2) (DSC-P71)	3:2 prints*
1600×1200	Printing A4 size images
1600 (3:2) (DSC-P51/P31)	3:2 prints*
1280×960	Printing postcard size images
640×480	For images to be attached to e-mail

## The number of images\* that can be saved in a “Memory Stick”

The number of images that can be saved in FINE (STANDARD) mode are shown below. (Units: number of images)

Capacity Image size	8MB	16MB	32MB	64MB	128MB
2048×1536 (DSC-P71)	5 (9)	10 (18)	20 (36)	40 (72)	80 (144)
2048(3:2) (DSC-P71)	5 (9)	10 (18)	20 (36)	40 (72)	80 (144)
1600×1200	8 (15)	16 (30)	32 (60)	64 (120)	128 (240)
1600 (3:2) (DSC-P51/P31)	8 (15)	16 (30)	32 (60)	64 (120)	128 (240)
1280×960	12 (22)	24 (44)	50 (93)	100 (186)	200 (372)
640×480	48 (118)	96 (240)	195 (488)	393 (983)	786 (1966)

\* When the shooting mode is normal  
For the number of images that can be saved in other modes, see page 91.

- The image size is the screen size used when viewing the images on a personal computer. When the images are viewed on the LCD screen of the camera, they all look the same size.
- Number of shooting images can differ from these values according to shooting conditions.
- The image size value (e.g., 2048×1536) is the number of pixels displayed.

For information how to shoot images to be used as attachments to e-mail messages, see page 65.

\* This option records images in a horizontal to vertical proportion of 3:2 to match the size of the print paper used.

# Basic still image shooting (using auto adjustment mode)

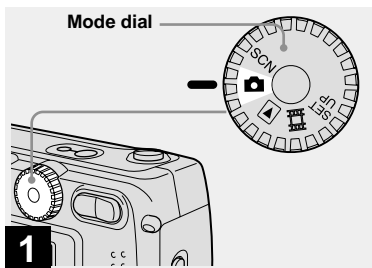

➔ Set the mode dial to , and turn on your camera.

- The lens cover opens when the power is turned on.
- When the camera is turned on or when using the zoom, and the lens is moving, don't touch the lens assembly (DSC-P71 only) (page 28).
- When the mode dial is set to , the exposure and focus are adjusted automatically.

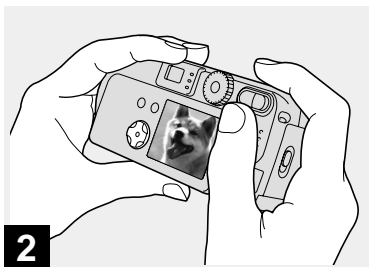

➔ Hold your camera with your both hands and position a subject in the center of the frame to focus on.

Do not cover the lens or flash with your fingers.

- You can choose either Multi-point AF mode or Center AF as the AF mode (page 58).

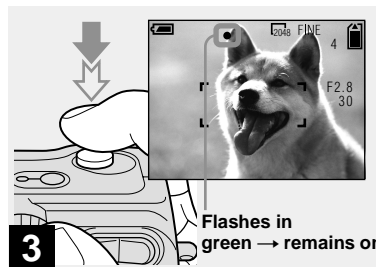

➔ Press and hold the shutter halfway down.

The camera beeps. When the AE/AF lock indicator stops flashing and remains on, the camera is ready for shooting.

- If you remove your finger from the shutter, shooting will be canceled.
- The minimum focal distance to a subject is 50cm (19 <sup>11</sup>/<sub>16</sub> inches) for the DSC-P71; 8cm (3 <sup>1</sup>/<sub>4</sub> inches) for the DSC-P51 with the Zoom button set to the W (wide angle) side, and 50cm (19 <sup>3</sup>/<sub>4</sub> inches) with the Zoom button set to the T (telephoto) side; and 10cm (3 <sup>15</sup>/<sub>16</sub> inches) or more for the DSC-P31. To shoot subjects at distances closer than this, use Macro mode (DSC-P71 only).
- The frame appearing on the LCD screen shows the limits of the area where the focus will be adjusted. (For more details on the AF range finder, see page 58.)

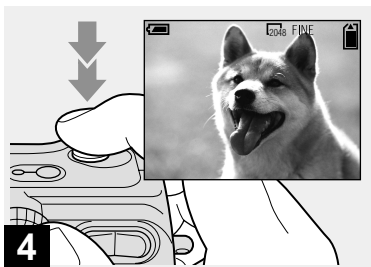

4

### → Press the shutter fully down.

A beeping sound is heard, the shooting is completed, and the still image is saved in the “Memory Stick.” When the Recording lamp (page 9) goes out, you can shoot the next image.

- When you are shooting with the battery, if no tasks are performed for a while\* with the camera turned on, power is automatically shut off to preserve battery power (page 20).

\* When POWER SAVE is set to ON:  
approximately 90 seconds  
When POWER SAVE is set to OFF:  
approximately 3 minutes

## About Auto Focus

When you try to shoot a subject that is hard to focus on, the AE/AF lock indicator will change to flashing slowly.

The Auto Focus function may be difficult to use with in the following subjects. In such cases, release the shutter, then try to recompose the shot and focus again.

- The subject is distant from the camera and dark
- The contrast of the subject and its background is poor
- The subject is seen through glass, such as a window
- A fast-moving subject
- The subject has a reflection, such as that from a mirror, or there is a luminous body and a lustrous subject
- A flashing subject

## Checking the last shot image (Quick Review)

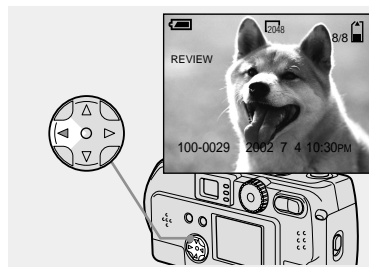

### → Press ◀ (⊖) on the control button.

To return to shooting mode, press the shutter lightly or press ◀ (⊖) on the control button again.

### To delete the image displayed on the LCD screen

- 1 Press MENU button to display the menu.
- 2 Press ▶ on the control button to select [DELETE], then press the center ●.
- 3 Press ▲ on the control button to select [OK], then press the center ●.  
The image will be deleted.

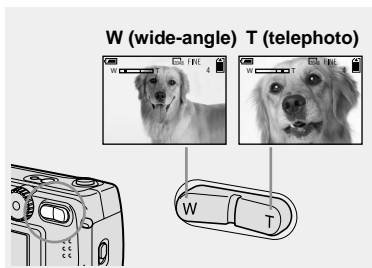

➔ Press the **W (wide angle)** or the **T (telephoto)** side of the Zoom button to choose the desired image size, and shoot your image.

### The minimum distance needed to focus on a subject

(From the end of the lens when the zoom button is set all the way to either the W or T side)

#### DSC-P71

50 cm (19 <sup>11</sup>/<sub>16</sub> inches) for both W and T

#### DSC-P51

8cm (3 <sup>1</sup>/<sub>4</sub> inches) for W, and 50cm (19 <sup>3</sup>/<sub>4</sub> inches) for T

#### DSC-P31

10 cm (3 <sup>15</sup>/<sub>16</sub> inches)

- The lens moves when the zoom feature is being used (DSC-P71 only). Be very careful not to touch the lens.
- The zoom feature cannot be used when shooting movies (page 74) (DSC-P71/P31 only).

## Digital zoom

### DSC-P71/P51

When the Zoom exceeds 3x for the DSC-P71 and 2x for the DSC-P51, the digital zoom feature enlarges the image up to a maximum of 6x using digital processing. Because picture quality deteriorates when digital zoom is used, set [DIGITAL ZOOM] in SET UP to [OFF] when this feature is not needed (page 97).

The **T side** of this line shows the extent of digital zoom

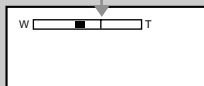

### DSC-P31

The DSC-P31 does not have an optical zoom. It has only a 3x digital zoom. There is no Digital zoom item in SET UP.

- When you are using digital zoom, you cannot confirm the image using the finder.
- When you are using the digital zoom feature, the Auto focus frame is not displayed.

## Shooting close-ups (Macro) (DSC-P71 only)





For close-ups of small subjects like flowers or insects, shoot using the Macro feature. You can use this feature for close-ups of subjects up to the distances specified below.

**When the zoom is set all the way to the W side:** 10 cm (3 <sup>15</sup>/<sub>16</sub> inches) from the end of the lens

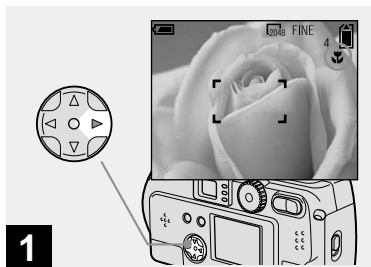
**When the zoom is set all the way to the T side:** 50 cm (19 <sup>11</sup>/<sub>16</sub> inches) from the end of the lens



**1** → Set the mode dial to , and press  on the control button.

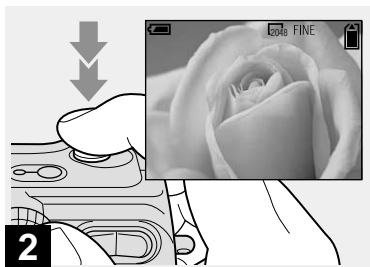

 (Macro) appears on the LCD screen.

- If the menu is currently displayed, press the MENU button first and the menu disappears.
- You can perform this operation even when the mode dial is set to SCN (other than Landscape mode) (page 34), or .





**2** → Center the subject in the frame, and shoot the image.

#### To return to normal shooting

Press  on the control button one more time.  disappears from the LCD screen.

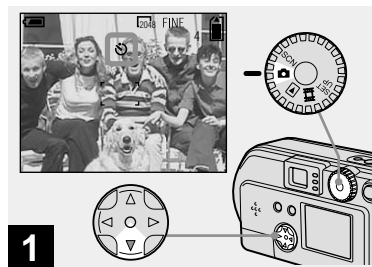
- Use the LCD screen to shoot when using the Macro feature. If you use the finder, the limits of what you see and what you actually shoot may be different.



**1** → Set the mode dial to , and press  on the control button.

 (Self-timer) appears on the LCD screen.

- If the menu is currently displayed, press the MENU button first and the menu disappears.
- You can perform this operation even when the mode dial is set to SCN, or .

## Selecting a flash mode

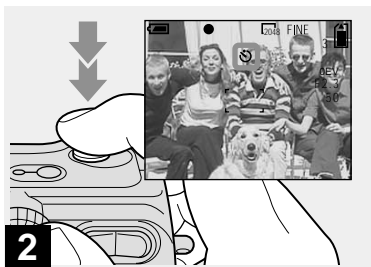

➔ **Center the subject in the frame, and press the shutter all the way down.**

The Self-timer lamp (page 8 for the DSC-P71, page 10 for the DSC-P51, page 12 for the DSC-P31) will blink in orange, and you will hear a beeping sound. The image will be shot within approximately 10 seconds.

### To cancel the self-timer during the operation

Press **▼** (⏸) on the control button one more time.

- If you stand in front of the camera and press the shutter, the focus and the exposure may not be correctly set.

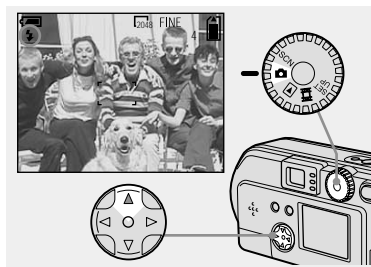

➔ **Set the mode dial to select , and press **▲** (⚡) on the control button repeatedly to select a flash mode.**

Flash mode has the following features.

**No indicator (Auto):** Based on the lighting conditions, the camera will decide if there is enough light, and will use the flash accordingly (factory setting).

**⚡ (forced flash):** The flash will be used regardless of the amount of ambient light.

**⊘ (no flash):** The flash will not be used.

Each time you press the button, the display changes as follows.

### When POWER SAVE is OFF

No indicator (Auto) → ⚡ (forced flash) → ⊘ (no flash)

### When POWER SAVE is ON

⊘ (no flash) → No indicator (Auto) → ⚡ (forced flash)

- If the menu is currently displayed, press the MENU button first and the menu will disappear.
- You can change the brightness of the flash using [FLASH LEVEL] in the settings menu (page 93).
- When Flash mode is set to Auto or ⚡ (forced flash), and you look at the LCD screen in a dark place, you may notice some “noise” in the image, but this will have no effect on the image you shoot.
- While the flash is being charged, the ⚡ Flash charging lamp blinks. When charging is completed, the lamp goes out.
- When you press the shutter button halfway down while the flash is flashing, the ⚡ Flash charge lamp turns on.

## To reduce “red-eye” when shooting live subjects

When the flash begins to strobe before the image is shot, the red-eye phenomenon is reduced. In SET UP, set [RED EYE REDUCTION] to [ON] (page 97).  appears on the LCD screen.



- The amount of red-eye reduction possible varies according to the individual. In addition, the distance to the subject, and whether or not the subject has seen the flash begin to strobe may also reduce the effectiveness of the red-eye reduction process.



## Shooting with the AF illuminator

This is additional lighting provided to assist in focussing when shooting in dark places.

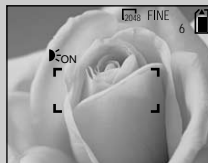
Set [AF ILLUMINATOR] (page 97) in SET UP to [AUTO]. When shooting,  appears; the AF illuminator will flash automatically during the time between when the shutter is pressed halfway down and the focus locks.



- When the AF illuminator flashes, but sufficient light does not reach the subject (the maximum recommended distance for this feature is approximately 2.8m (9.2 ft.) (wide) and 1.8m (5.9 ft.) (tele) for the DSC-P71, 2.2m (7.2 ft.) (wide/tele) for the DSC-P51, and 2.5 m (8.2 ft.) for the DSC-P31, or the subject has weak contrast, the camera may not focus properly.

- The light from the AF illuminator may miss the center of the image somewhat, but as long as it reaches the subject, the camera will focus properly.
- When the focus is adjusted manually, the AF illuminator doesn't function.
- When shooting in following Scene Selection mode (see page 34), the AF illuminator will not function.
  - : in Twilight mode
  - : in Landscape mode
- The AF illuminator is a bright light. There are no safety hazards, but when shooting at short distances, do not aim it directly at the subject's eyes.

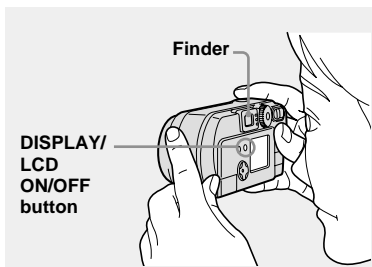

The finder is convenient when you want to save battery power, or when it is difficult to confirm the image using the LCD screen. Each time you press the DISPLAY/LCD ON/OFF button, the display changes in the following order.



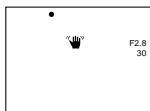

When the LCD screen display is off (only warning messages are displayed)

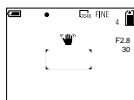

LCD screen display is OFF

Screen display is set to ON.



- For further details on the items displayed, see page 103.
- Just as with the AE/AF lock indicator on the LCD screen display, when the AE/AF lock lamp of the Finder section stops flashing and remains lit, you can start shooting again (page 26).
- When the LCD screen display is turned off, the digital zoom does not function (page 28).
- When the LCD screen display is turned off, if you press the  (Flash mode) or  (Self-timer) or  (Macro, DSC-P71) or  (SPOT METER, DSC-P51/P31), the image will be displayed on the screen for approximately 2 seconds so you can check or change the setting.

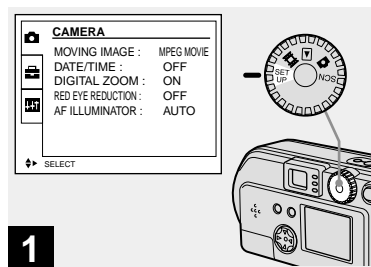

➔ Set the mode dial to SET UP.

The SET UP menu is displayed.

- When images are shot with the date and time inserted, the date and time cannot be removed later.
- When shooting images with the date and time inserted, the actual date and time are not displayed on the LCD screen, instead, **DATE** is displayed in the upper left portion of the LCD screen. The actual date and time are displayed when the image is played back.
- When you have chosen a date format, you can choose [Insert the correct date and time] (page 21), and the information will be inserted in the format you chose.
- The “DIGITAL ZOOM” item is not displayed on the SET UP screen of the DSC-P31 (page 28).



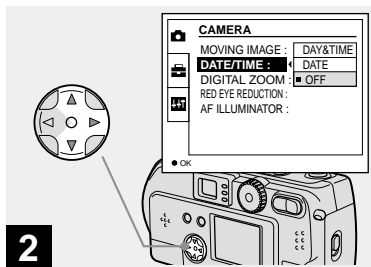

- 2** → Select **📷** (CAMERA) using **▲/▼** on the control button and press **▶**.  
Select **[DATE/TIME]** using **▲/▼** and press **▶**.

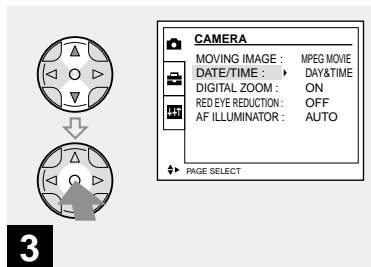

- 3** → Choose the type of data to be inserted using **▲/▼** on the control button, then press the center **●**.

**DAY & TIME:** Inserts the date and the time of shooting into the image

**DATE:** Inserts the year, the month and the date of shooting into the image

**OFF:** Does not insert date/time data into the image

After the setting has been completed, turn the mode dial to **📷**, and continue your shooting.

- You can also carry out this operation when the mode dial is set to SCN.
- The settings made here will be saved even when the power is turned off.

## Shooting according to scene conditions (SCENE SELECTION)

### Twilight mode



### Twilight portrait mode



### Landscape mode



Ordinarily shoot with the camera set to Auto (mode dial: ) , but when shooting scenes or people in the dark places, or shooting landscapes, use the modes listed below to increase the quality of your images.

### Twilight mode

Under dark lighting conditions, you can shoot using the Twilight mode, and still get good images. However, because the shutter speed is slower under these conditions, we recommend you use a tripod.

- The flash cannot be used.

### Twilight portrait mode

Use this mode when shooting people in the foreground at night.

Because the shutter speed is slow, it is recommended that you use a tripod.

- Allows you to shoot images of people in the foreground with distinct outlines without losing the feeling that you are shooting at night.
- The flash automatically strobos.

### Landscape mode

Focuses on images far away, so is convenient for shooting landscapes at a distance.

- You cannot shoot in Macro mode.

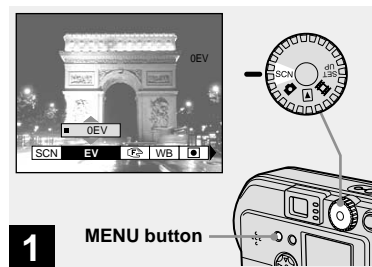

➔ **Set the mode dial to SCN, and press the MENU button.**

The menu appears.

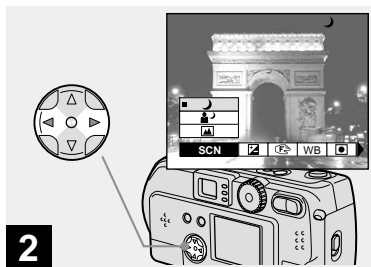

**2** → Select [SCN] using **◀▶** on the control button.

-  (SPOT METER) is not displayed on the menu of the DSC-P51/P31 (page 61).

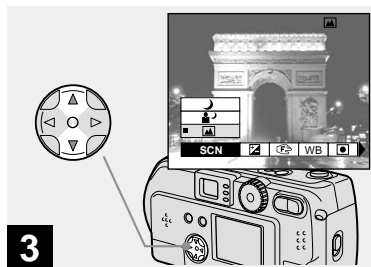

**3** → Select the desired mode using **▲▼** on the control button.

The mode will be set to your choice. When the setting is completed, press the MENU button. The menu disappears from the screen.

- When you cancel Scene selection, set the mode dial to something other than SCN.
- The settings made here will be saved even when the power is turned off.

## NR slow shutter

In Twilight or Twilight portrait mode, when the shutter speed becomes a 1/2 second or slower, “NR” is displayed before the shutter speed indication, and the camera automatically changes to the NR slow shutter mode.

The NR slow shutter mode removes noise from recorded images, providing clear images. To eliminate the effects of vibration, use of a tripod is recommended.

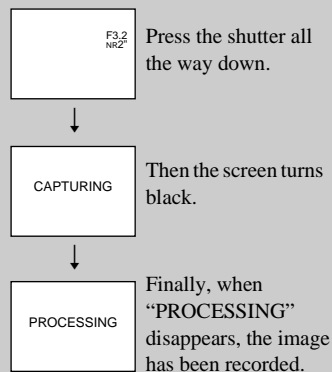



## Viewing images on the LCD screen of your camera

### Single (single-image display)



### Index (nine-image display)

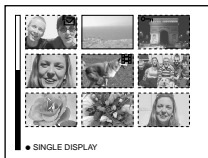

### Index (triple-image display)

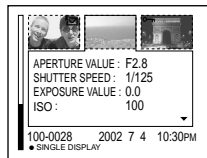

You can see the images you shoot with this camera almost immediately on the LCD screen. This camera offers the following three methods for viewing your images.

#### Single (single-image display)

You can view one image at a time, occupying the entire screen.

#### Index (nine-image display)

Nine images will be displayed simultaneously in separate panels on the screen.

#### Index (triple-image display)

Three images will be displayed simultaneously in separate panels on the screen. Various items of image information will also be displayed.

- For movies, see page 75.
- For information on the various symbols displayed, see page 105.

## Viewing single images

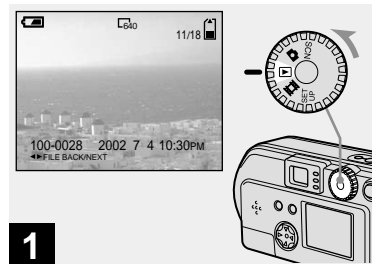

➔ **Set the mode dial to , and turn on the power.**

The last image you shot will be displayed.

## Viewing Index (nine- or triple-image display)

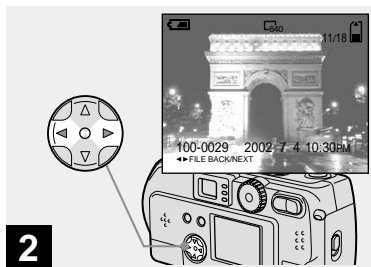

➔ **Select Still Image using ◀▶ on the control button.**

- ◀ : Displays the previous image.
- ▶ : Displays the next image.

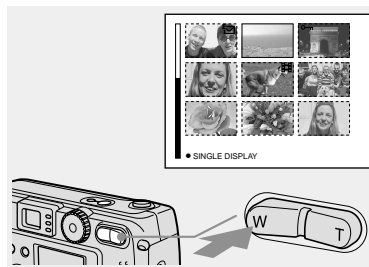

➔ **Press the Zoom W button once.**

The display switches to the **Index (nine-image) screen**.

**To display the previous (next) Index screen**

Press ▲/▼/◀/▶ on the control button to move the yellow frame up/down/left/right.

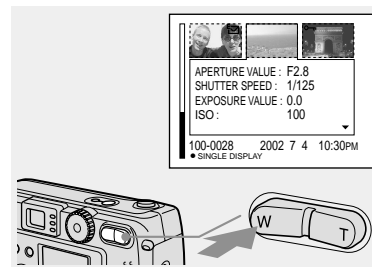

➔ **Press the Zoom W button once more.**

The display switches to the **Index (triple-image) screen**.

When you press ▲/▼ on the control button, the remaining image information is displayed.

**To display the previous (next) Index screen**

Press ◀/▶ on the control button.

**To return to the single-image screen**

Repeatedly press the Zoom T button, or press the center ● on the control button.

# Viewing images on a TV screen

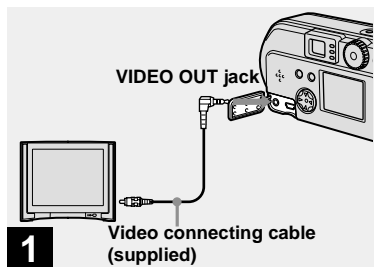

➔ Using the video connecting cable, connect the VIDEO OUT jack of the camera to the Image of the TV set.

- Connect the video cable to the camera and the TV set only after confirming that both are turned off.



➔ Turn on the power of the TV set, and set the TV/Video toggle switch of the TV to "Video."

- Depending on your TV set, the name and location of this switch may be different.

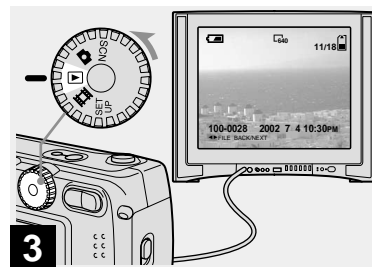

➔ Set the mode dial to  and turn on the camera.

Press  on the control button to select an image.

- When using this feature, it may be necessary to switch the video output signal to match that of your TV system (see page 98).

# Deleting images

## Watching the playback picture on TV

If you want to view the playback picture on a TV, you need a TV having a video input jack and a video connecting cable.

The color system of the TV must be the same as that of your digital still camera. Check the following list:

### NTSC system

Bahama Islands, Bolivia, Canada, Central America, Chile, Colombia, Ecuador, Jamaica, Japan, Korea, Mexico, Peru, Surinam, Taiwan, the Philippines, the U.S.A., Venezuela, etc.

### PAL system

Australia, Austria, Belgium, China, Czech Republic, Denmark, Finland, Germany, Holland, Hong Kong, Italy, Kuwait, Malaysia, New Zealand, Norway, Portugal, Singapore, Slovak Republic, Spain, Sweden, Switzerland, Thailand, United Kingdom, etc.

### PAL-M system

Brazil



### PAL-N system

Argentina, Paraguay, Uruguay

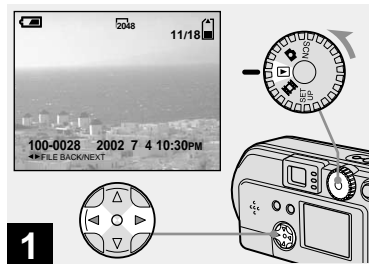

### SECAM system

Bulgaria, France, Guiana, Hungary, Iran, Iraq, Monaco, Poland, Russia, Ukraine, etc.

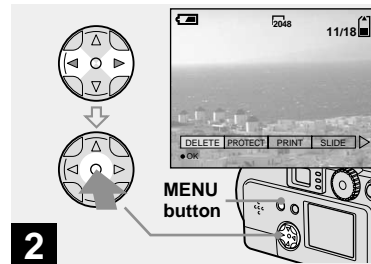

➔ Set the mode dial to  and turn on the camera. Press  on the control button to select an image to be deleted.



➔ Press the MENU button, press  on the control button to select [DELETE], then press the center .

The image has not yet been deleted at this point.

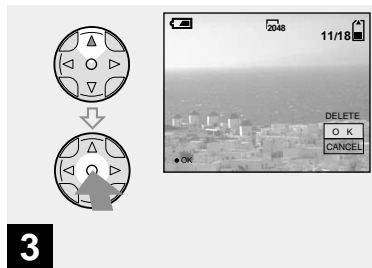

- 3** → Select [OK] using ▲ on the control button, then press the center ●.

“MEMORY STICK ACCESS” appears on the screen. When this message disappears, the image has been deleted.

#### To cancel the deletion

Using ▼ on the control button, choose [CANCEL], then press the center ●.

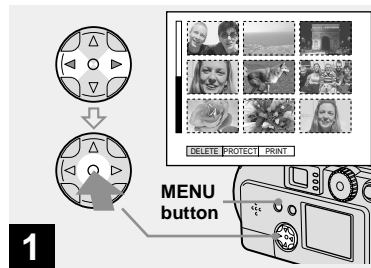

- 1** → While an Index (nine-image) screen (page 37) is displayed, press the MENU button, select [DELETE] using ◀/▶ on the control button, then press the center ●.

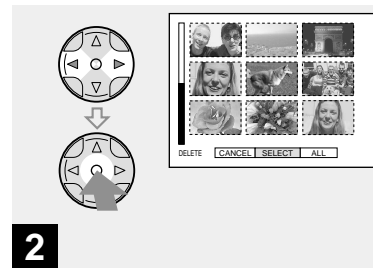

- 2** → Select [SELECT] using ◀/▶ on the control button, then press the center ●.



#### To delete all the images

Select [ALL] using ◀/▶ on the control button, then press the center ●. Select [OK] again, and press the center ●. To cancel the deletion, select [EXIT], then press the center ●.

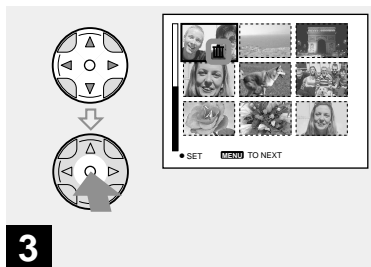



- 3** → Select the image you want to delete using ▲/▼/◀/▶ on the control button then press the center ●.

The  (Delete) mark appears on the selected image. At this point, the image has not yet been deleted. Put the  (Delete) marks on all of the images you want to delete.

- To cancel your selection, press the center ● one more time.

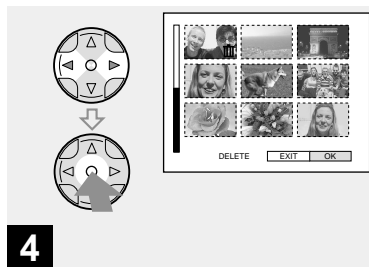

- 4** → Press the MENU button, select [OK] using ◀/▶ on the control button, then press the center ●.

When “MEMORY STICK ACCESS” disappears, the images have been deleted.

#### To cancel the deletion

Using ◀ on the control button, select [EXIT], then press the center ●.

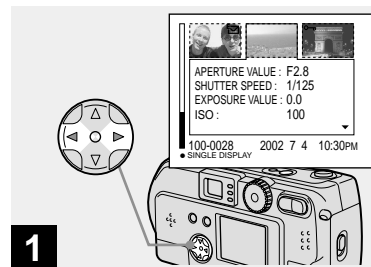

- 1** → While an Index (triple-image) screen (page 37) is displayed, display the image you want to delete to the center using ◀/▶ on the control button.

*Deleting on the Index (triple-image) screen (continued)*

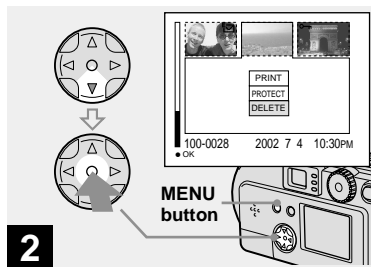

- 2** → Press the MENU button, and select [DELETE] using the ▼ on the control button, then press the center ●.

At this point, the image has not yet been deleted.

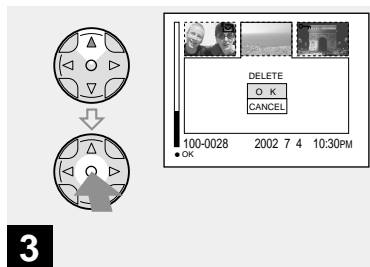

- 3** → Select [OK] using ▲ on the control button, then press the center ●.

When “MEMORY STICK ACCESS” disappears, the image has been deleted.

**To cancel the deletion**

Use ▼ on the control button to select [CANCEL], then press the center ●.

# Formatting a "Memory Stick"

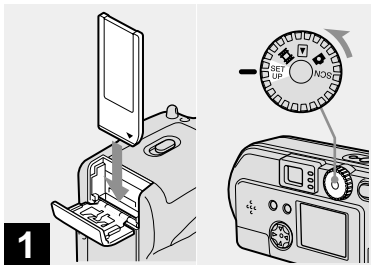

**1** → Insert the "Memory Stick" you want to format into the camera. Set the mode dial to SET UP, and turn on the power.

- The term "formatting" means preparing a "Memory Stick" to record images; this process is also called "initialization." The "Memory Stick" provided with this camera, and those available commercially, are already formatted, and can be used immediately. **When you format a "Memory Stick," be aware that all of the images in the "Memory Stick" will be permanently deleted.**

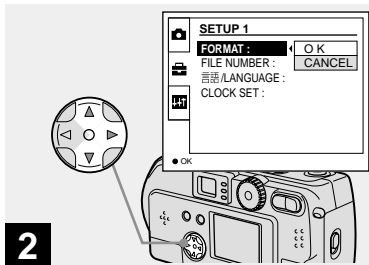

**2** → Select  (SETUP 1) using ▲/▼ on the control button, select [FORMAT] by pressing ►. Then, press ►, select [OK] using ▲/▼, and press the center ●.

## To cancel the formatting

Select [CANCEL] using ▼ on the control button, then press the center ●.

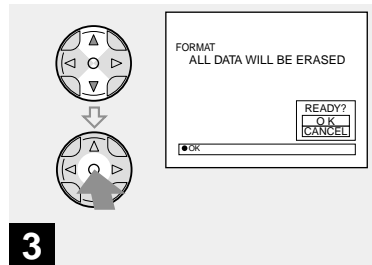

**3** → Select [OK] using ▲/▼ on the control button, then press the center ●.

The "FORMATTING" message appears. When this message disappears, the format is complete.



# Copying still images to your computer

Follow the steps below to copy the images you shot to your computer.

## Steps required by your OS (Operating System)

OS	Steps
Windows 98/98SE/2000/Me	Steps ❶ to ❺ (pages 45 to 53)
Windows XP	Steps ❷ to ❺ (pages 46, 47, 49 to 53)
Mac OS 8.5.1/8.6/9.0/9.1/9.2, Mac OS X (v10.0/v10.1)	Page 54

- Step ❶ may be unnecessary depending on your OS.
- After you complete the installation of the USB driver, step ❶ is unnecessary.

## Recommended computer environment

### Recommended Windows environment

OS: Microsoft Windows 98, Windows 98SE, Windows 2000 Professional, Windows Millennium Edition, Windows XP Home Edition, or Windows XP Professional  
 An OS installed at the factory (not upgraded) is required for correct

operations. We cannot guarantee operations for operating systems not listed above.

CPU: MMX Pentium 200 MHz or faster  
 USB connector:  
 Provided as standard equipment

### Recommended Macintosh environment

OS: Mac OS 8.5.1, 8.6, 9.0, 9.1, 9.2, or Mac OS X (v10.0/v10.1)  
 An OS installed at the factory is required for correct operations. For the following models, update your OS to Mac OS 9.0 or 9.1.

- iMac with Mac OS 8.6 installed at the factory, and a slot loading type CD-ROM drive
- iBook or Power Mac G4 with the Mac OS 8.6 installed at the factory

USB connector:  
 Provided as standard equipment

- If you connect two or more USB devices to your computer at one time, some devices, including your camera, may not work, depending on the type of USB device.
- Operations are not guaranteed when using a USB hub.
- Operations are not guaranteed for all the recommended environments mentioned above.

## USB mode

There are two modes for a USB connection, [NORMAL] and [PTP] modes. The factory setting is the [NORMAL] mode. This section describes the USB connection using the [NORMAL] mode.

## Communication with your computer (for Windows users only)

If you recover your computer from the suspend or sleep mode, communication between your camera and your computer may not recover at the same time.

## When a USB connector is not provided on your computer

When neither a USB connector nor a “Memory Stick” slot is provided, you can copy images using an additional device. See the Sony Website for details.



# Installing the USB driver

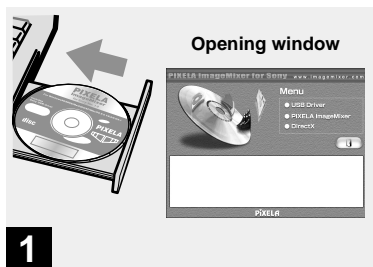

98 2000  
98SE Me



1

➔ Turn on your computer, and insert the supplied CD-ROM into the CD-ROM drive.

Do not connect your camera to your computer at this time.

The opening window appears. If it does not appear, double-click  (My Computer) →  (ImageMixer) in order.

- This section describes how to establish a USB connection using Windows Me as an example. Required operations may be different depending on your OS.
- **Shut down all other applications before installation of the driver.**
- When you are using Windows 2000, log on as Administrators.

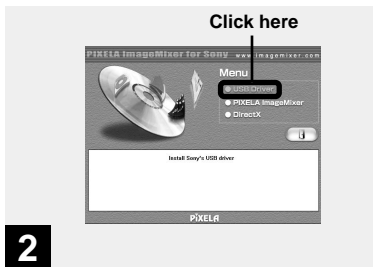

2

➔ Click [USB Driver] on the opening window.

The “InstallShield wizard” window appears.



3

➔ Click [Next]. When the [Information] window appears, click [Next], and eject the CD-ROM.

The USB driver installation starts. When the installation is completed, the window informs you of completion.



➔ Click [Yes, I want to restart my computer now], then click [Finish].

Your computer restarts. Then, you can establish the USB connection.

- You can use the “PIXELA ImageMixer for Sony” software to copy images to your computer. To install this software, click “PIXELA ImageMixer,” on the opening succeeding window, then follow instructions on each window.
- Be sure to install DirectX when using the “PIXELA ImageMixer for Sony” software. Click [DirectX] and follow instructions on each succeeding window. Your computer restarts when the installation is completed.

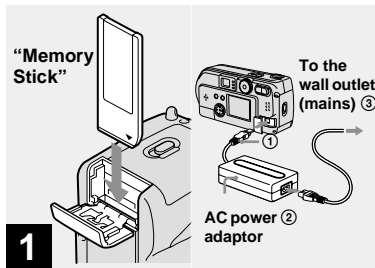

➔ Insert the “Memory Stick” with the images you want to copy into the camera. Connect the camera and the AC power adaptor, and plug the adaptor into a wall outlet (mains).

- For further details on the “Memory Stick,” see page 23.
- For further details on the AC power adaptor, see page 19.

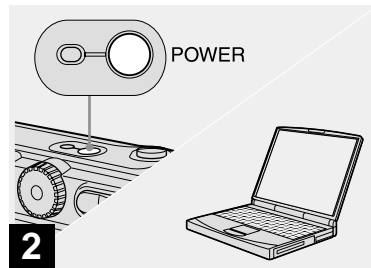

➔ Turn on your computer and your camera.

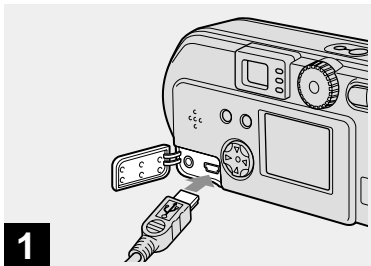

➔ **Open the jack cover, and connect the supplied USB cable to your camera. Then, connect the other end of the USB cable to your computer.**

- When using a desktop computer, connect the USB cable to the USB connector on the rear panel.
- When using Windows XP, the copy wizard automatically appears on the desktop. Proceed to page 49.

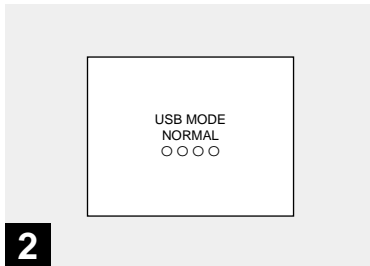



“USB MODE NORMAL” appears on the LCD screen of your camera. When a USB connection is established for the first time, your computer automatically runs the used program to recognize your camera. Wait for a while.

- If “USB MODE NORMAL” does not appear, confirm that [USB CONNECT] is set to [NORMAL] in the SET UP settings (page 98).

## Removing the USB cable from your computer or the “Memory Stick” from your camera during a USB connection

For Windows 2000, Me, or XP users

- 1 Double-click  on the taskbar.
- 2 Click , then click [Stop].
- 3 Confirm the device on the confirmation window, then click [OK].
- 4 Click [OK].  
This step is unnecessary for Windows XP users.
- 5 Disconnect the USB cable or remove the “Memory Stick.”

For Windows 98 or 98SE users

Carry out only Step 5 above.

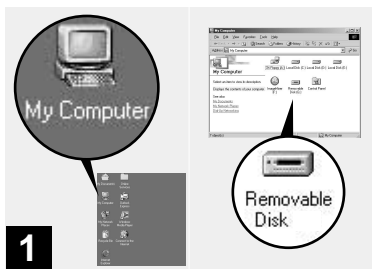

- 1** → Double-click [My Computer], then double-click [Removable Disk].

The contents of the “Memory Stick” inserted in your camera appear.

- This section describes an example of copying images into the “My Documents” folder.
- When using Windows XP, see pages 49 to 51.
- When the “Removable Disk” icon does not appear, see the next page.
- You can use the “PIXELA ImageMixer for Sony” software to copy images to your computer. For details, see the software’s help files.

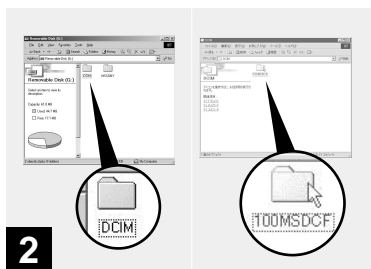

- 2** → Double-click [DCIM], then double-click [100MSDCF].

The “100MSDCF” folder opens.

- The “100MSDCF” folder contains the image files you shot using your camera.
- The folder names vary depending on the type of images they contain (page 51).

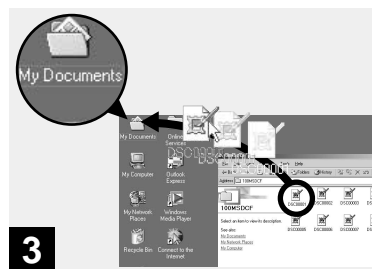

- 3** → Drag and drop the image files into the “My Documents” folder.

The image files are copied to the “My Documents” folder.

- When you try to copy an image to a folder in which an image with the same file name is stored, the overwrite confirmation message appears. When you want to overwrite the existing image with the new one, click [Yes]. When you do not want to overwrite it, click [No], then change the file name.



When a removable disk icon is not shown

- 1 Right-click [My Computer], then click [Property].  
The “System Property” window appears.
- 2 Confirm if other devices are already installed.
  - ① Click [Device Manager].
  - ② Double-click [?] Other Devices].
  - ③ Confirm if there is a “? Sony DSC” or “? Sony Handycam” with a ? mark.
- 3 If you find either of the devices above, follow the steps below to delete them.
  - ① Click [?] Sony DSC] or “? Sony Handycam.”
  - ② Click [Delete].  
The “Device deletion confirmation” window appears.
  - ③ Click [OK].  
The device is deleted.

Try the USB driver installation again using the supplied CD-ROM (page 45).

#### 4 Copying images **XP**

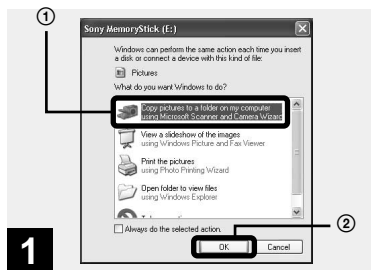

- ➔ Click [Copy pictures to a folder on my computer using Microsoft Scanner and Camera Wizard] window, then click [OK].

The “Scanner and Camera Wizard” window appears.

- When following the steps on page 47, the copy wizard appears on the desktop of your computer.



- ➔ Click [Next].

The images stored in the “Memory Stick” are displayed.

#### 4 Copying images XP (continued)

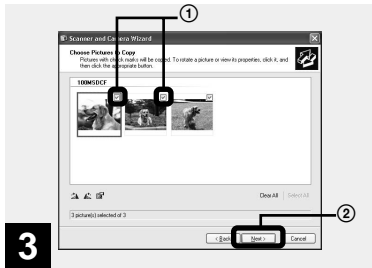

→ Click  to remove the checkmark from any images you do not want to copy to your computer, then click [Next].

The “Picture Name and Destination” window appears.

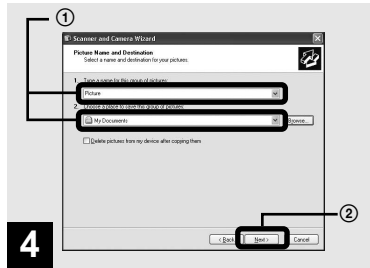

→ Specify the image file names to be copied and the copy destination, then click [Next].

Copying of the images starts. When the task is completed, the “Other Options” window appears.

- Copy images into the “My Documents” folder.

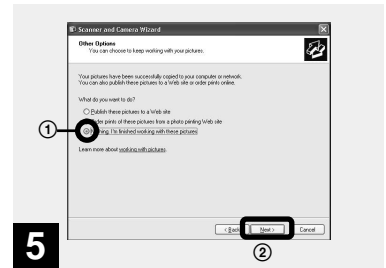

→ Click [Nothing. I'm finished working with these pictures], then click [Next].

The “Completing the Scanner and Camera Wizard” window appears.

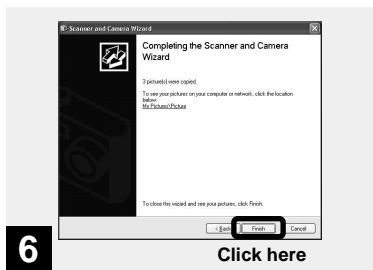

→ Click [Finish].

The wizard window closes.

- When you want to continue copying other images, disconnect the USB cable once and reconnect it. Then, follow the process from Step 1.

## Image file storage destinations and file names

The image files recorded with your camera are grouped as folders in the “Memory Stick,” depending on the recording modes.

### Example: when viewing folders on Windows Me

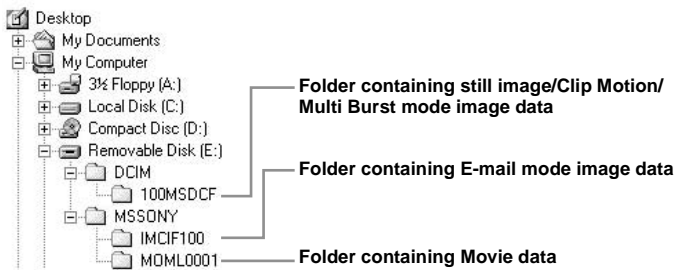

Folder	File name	File meaning
100MSDCF	DSC0□□□□.JPG	<ul style="list-style-type: none"> <li>• Still image files shot normally</li> <li>• Still image files shot in                             <ul style="list-style-type: none"> <li>– E-MAIL mode (page 65)</li> <li>– Multi Burst mode (page 64)</li> </ul> </li> </ul>
	CLP0□□□□.GIF	• Clip Motion files shot in NORMAL mode (page 62)
	CLP0□□□□.THM	• Index image files of Clip Motion files shot in NORMAL mode
	MBL0□□□□.GIF	• Clip Motion files shot in MOBILE mode (page 62)
	MBL0□□□□.THM	• Index image files of Clip Motion files shot in MOBILE mode
IMCIF100	DSC0□□□□.JPG	• Small-size image files shot in E-MAIL mode (page 65)
MOML0001	MOV0□□□□.MPG	• Movie files shot normally (page 74)

**Note on the table**

- The meanings of the file names are as above:
  - stands for any number within the range from 0001 to 9999.
- The numerical portions of the following files are the same.
  - A small-size image file shot in E-MAIL mode and its corresponding image file
  - An image file shot with Clip Motion and its corresponding index image file

## 5 Viewing the images on your computer

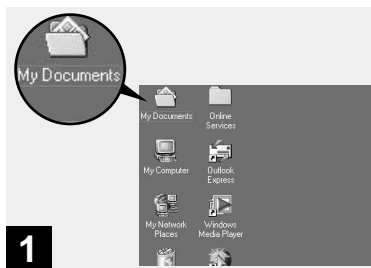

➔ **Double-click [My Documents] on the desktop.**

The “My Documents” folder opens.

- This section describes the steps followed for copying images to the “My Documents” folder on pages 48, 49.
- When using Windows XP, click [Start]→[My Documents] in that order.
- You can use the “PIXELA ImageMixer for Sony” software to view images on your computer. For details, see the software’s help files.

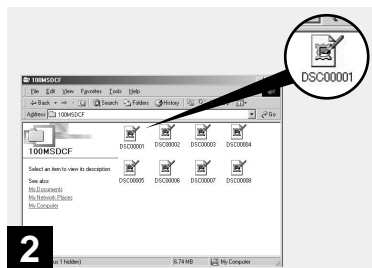

➔ **Double-click the desired image file.**



The image file opens.

Follow the steps below, according to your OS.

OS	Steps
Mac OS 8.5.1/8.6/9.0	Steps ① to ⑤
Mac OS 9.1/9.2/ Mac OS X(v10.0/v10.1)	Steps ② to ⑤

## ① Installing the USB driver

(For Mac OS 8.5.1, 8.6, or 9.0 users only)

- 1 Turn on your computer, and set the supplied CD-ROM to the CD-ROM drive.  
The “PIXELA ImageMixer” window appears.
- 2 Double-click  (Setup Menu).
- 3 Click  (USB Driver).  
The “USB Driver” window appears.
- 4 Double-click the icon of the hard disk containing the OS to open the window.
- 5 Drag and drop the following two files from the window opened in step 3 to the System Folder icon in the window opened in step 4.
  - Sony USB Driver
  - Sony USB Shim

- 6 When the message “Do you want to put these items into Extension Folder?” is shown, click [OK].
- 7 Restart your computer.

## ② Preparing your camera

For details, see page 46.

## ③ Connecting your camera to your computer

For details, see page 47.

### Removing the USB cable from your computer or the “Memory Stick” from your camera during a USB connection.

Drag and drop the drive icon of the “Memory Stick” to the “Trash” icon, then remove the USB cable or “Memory Stick.”

\* If you are using Mac OS X, remove the USB cable, etc., after you have turned your computer off.

## ④ Copying images

- 1 Double-click the newly recognized icon on the desktop.  
The contents of the “Memory Stick” inserted in your camera appear.
- 2 Double-click [DCIM].

- 3 Double-click [100MSDCF].
- 4 Drag and drop the image files to the hard disk icon.  
The image files are copied to your hard disk.

## ⑤ Viewing the images on your computer

- 1 Double-click the hard disk icon.
  - 2 Double-click the desired image file in the folder containing the copied files.  
The image file opens.
- You can use the “PIXELA ImageMixer for Sony” software to copy images to your computer and view the images on your computer. To install the software, insert the supplied CD-ROM drive, then click the installer icon to select the desired language under “PIXELA ImageMixer” on the opening window and follow the instructions on each window. For details, see the software’s help files.

# How to setup and operate your camera

Here we will explain the most commonly used menus and the SET UP screen.

## Control button

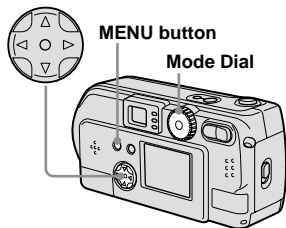

## Changing menu settings

- 1 Press the MENU button and the menu will be displayed.**

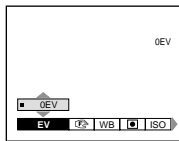

- 2 Select the setting item you want to change using ◀▶ on the control button.**

The letters and symbols of the item you select will turn yellow.

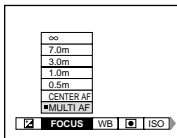

- 3 Select the desired setting using ▲/▼ on the control button.**

The frame of the selected setting will turn yellow, and the setting will be made.

-  (SPOT METER) is not displayed on the menu of the DSC-P51/P31 (page 61).

## To turn off the menu display

Press the MENU button.

## Changing items in the SET UP screen

- 1 Set the mode dial to SET UP, and the SET UP screen appears.**

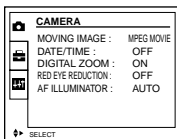

- 2 Select the setting item you want to change using ▲▼/◀▶ on the control button.**

The frame of the item you select will turn yellow.

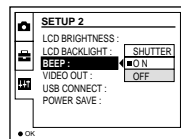

- 3 Press the center ● on the control button to enter the setting.**

- On the DSC-P31, the "DIGITAL ZOOM" (page 28) and "POWER SAVE" (page 16) items are not displayed. On the DSC-P51/P31, the "POWER SAVE" (page 16) item is not displayed.

## To turn off the SET UP screen display

Set the mode dial to anything other than SET UP.

## Adjusting the exposure

### – EV adjustment

**Mode dial:** /SCN/

Used when you want to change the automatic exposure to one of your own choice. The value can be set over a range from +2.0EV to –2.0EV, in 1/3EV increments.

Control button

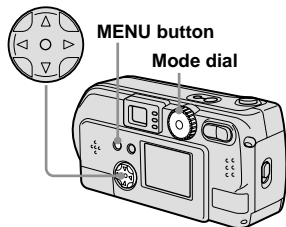

**1** Set the mode dial to , SCN, or .

**2** Press the MENU button.

The menu appears.

**3** Select (EV) using /

The value of the exposure adjustment is displayed.



### **4** Select the exposure adjustment value.

Select the exposure adjustment value using /

Make your adjustment while confirming the brightness of the background of the subject on the LCD screen.

### To return to auto adjust mode

Return the exposure adjustment value to 0 EV.

- (SPOT METER) is not displayed on the menu of the DSC-P51/P31 (page 61).
- When the subject is at the brightest or darkest ends of the range, or when you are using the flash, the adjustment value set may not actually be used.

## Shooting techniques

In normal shooting, the camera makes automatic exposure adjustments. Check the image to be shot, if it looks like the image below, you should make manual adjustments. If you are shooting a back-lit person or a snowy scene, make your adjustments in the + plus direction; if you have a dark subject that fills the screen, making your adjustments in the – direction should give the best results.



**Inadequate exposure**  
→ Adjust in the + direction



**Appropriate exposure**



**Overexposed** → Adjust in the – direction



## Adjusting color tones

### – WHITE BALANCE

#### Mode dial: /SCN/

When shooting images using automatic features, the white balance is set automatically in response to the condition of the subject, and the overall color balance is adjusted accordingly. When you want to fix the conditions under which the image is captured, or when shooting under special lighting conditions, you can select the settings manually.

#### AUTO (no display)

The white balance is adjusted automatically.

#### Daylight

Used when shooting outdoors, and for shooting at night, under neon lights, for fireworks, sunrises and sunsets.

#### Cloudy

Used when shooting under a cloudy sky.

#### Fluorescent





Used when shooting under fluorescent lights.

#### Incandescent

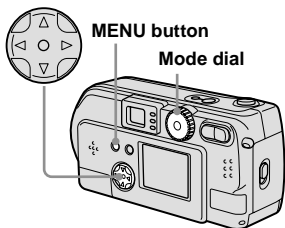
- Used when shooting, for example, at a party, where the lighting conditions change often
- Used in a studio, or under video lights
- Used when shooting under sodium or mercury lights

#### Control button



- 1 Set the mode dial to , SCN, or .**
- 2 Push the MENU button.**  
The menu appears.
- 3 Select [WB] (WHITE BALANCE) using , then select the desired setting using .**

#### To return to automatic settings

In Step **3**, select [AUTO].

- Under fluorescent lights that flicker, even if you choose Fluorescent, you may feel that the overall color of the image may show differences from the actual color.
- When the flash is triggered, the manual setting is cancelled, and the shooting of the image is done in “AUTO” mode.

#### Shooting techniques

The color of the subject that you see will be captured according to the lighting conditions. Under the bright summer sun, everything will appear bluish, under a light source like a light bulb, white objects will appear reddish. The human eye has an excellent ability to adjust. Even when lighting conditions change, the eye can adjust and recognize the correct color almost instantly. However, digital still cameras are greatly influenced by light. Normally, this camera adjusts automatically, but if you notice that the color of the entire image seems to be a bit unnatural when replaying an image on the LCD screen, it is recommended that you adjust the white balance.

## Choosing a focus method

### – MULTI AF/CENTER AF

Mode dial: /SCN/

#### Multipoint AF

When you use Multipoint AF, it calculates the distance in three places, in the center of the image, and to both the left and right of the center, you can shoot with the auto focus function without being dependent on the composition of the image. It is useful when it is difficult to focus on the subject because it is not in the center of the frame.

#### Center AF

You can focus automatically using the AF range finder in the center of the frame.

##### Control button

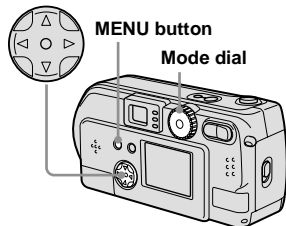

**1** Set the mode dial to either , SCN, or .

**2** Press the MENU button.

**3** Select (FOCUS) using / , select [MULTI AF] or [CENTER AF] using / .

The focus is adjusted automatically. The color of the AF range finder frame changes from white to green.

#### Multipoint AF

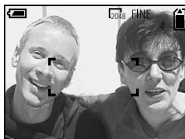

#### Center AF



- When you are shooting movies (MPEG MOVIE) and you choose Multipoint AF, the distance to the center of the screen is estimated as an average, so the AF works even with a certain amount of vibration. The Center AF automatically focuses only on the center of the image, so it is convenient when you want to focus only on what you aim at.
- When you use Digital zoom or AF illuminator, priority AF movement is given to subjects in or near the center of the frame. In this case, the AF range finder isn't displayed.

## Shooting with the AF lock using Center AF

If it is difficult to focus because the subject is not in the center of the frame, you can focus in this situation using the AF range finder. For example, when you are shooting two human subjects, and there is a gap between them, the camera may focus on the background visible in the gap. In a case like this, use AF lock to ensure the subjects are in correct focus.

- When you are using AF lock, you can capture an image with the correct focus even if the subject is at the edge of the frame.

### 1 Compose the shot so that the subject is centered in the AF range finder, and press the shutter halfway down.

First, the focus for the subject you are aiming at will be adjusted. When the AE/AF lock indicator stops flashing and remains on, and there is a beeping sound, focus adjustment is completed.

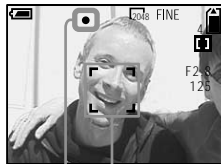

AF range finder

AE/AF lock indicator

### 2 Return to the fully composed shot, and press the shutter down again.

When you hear a beeping sound, the image will be recorded with the proper focus for the human subjects.



- You can carry out the AF lock adjustment process any number of times, as long as you do it before you press the shutter.

## Setting the distance to the subject

### – Focus preset

**Mode dial:** /SCN/

When shooting an image using a previously set distance to the subject, or when shooting a subject through a net or through window glass, it is difficult to get the proper focus using the auto focus function. This is when use of the Focus preset is convenient.

#### Control button

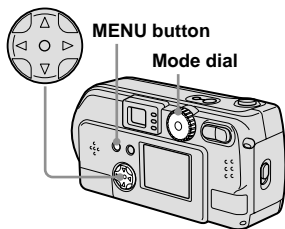

**1** Set the mode dial to , SCN, or .

**2** Press the MENU button.

The menu appears.

**3** Select (FOCUS) using / , then select the distance to the subject using / .

You can select from the following distance settings.  
0.5m, 1.0m, 3.0m, 7.0m, ∞ (unlimited distance)

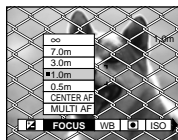

### To return to auto focus

Press the MENU button again, select (FOCUS), then select [MULTI AF] or [CENTER AF].

- (SPOT METER) is not displayed on the menu of the DSC-P51/P31 (page 61).
- The focus distance settings include a small margin of error. Use them as guidelines only.
- If you point the lens up or down, the error increases (DSC-P71 only).

## Adding special effects

### – PICTURE EFFECT

**Mode dial:** /SCN/

You can add special effects to bring out the contrast in your images.

#### SOLARIZE



Like an illustration with clearly delineated bright and dark portions

#### B&W



In black and white

#### SEPIA



Colored to look like an old photograph

#### NEG.ART



Made to look like a negative image

**1** Set the mode dial to , SCN, or .

**2** Press the MENU button.  
The menu appears.

**3** Select [PFX] (P. EFFECT) using , then select the desired mode using .

### To cancel Picture Effect

In Step **3**, select [OFF]

## Spot light-metering

Mode dial: /SCN/

When there is backlight, or the background of the subject provides a very high contrast, you can adjust the focus to that most appropriate for your subject. You can aim at a particular point, and meter the light to adjust the focus for that point.

- When the place you want to focus on and the place you are using Spot light-metering on are the same, it is recommended that you use Center AF (page 58).

### Control button

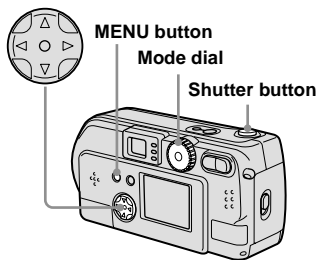

For the DSC-P71

**1** Set the mode dial to , SCN, or .

**2** Press the MENU button.  
The menu appears.

**3** Select (SPOT METER) using , then select [ON] using .

The Spot light-metering aiming point is displayed.

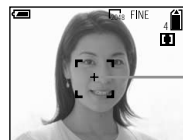

**4** Aim the Spot light-metering aiming point at the spot you want to shoot, then shoot your image.

## To cancel Spot light-metering

Press the MENU button again, select  (SPOT METER) using ◀/▶ on the control button, then select [OFF] using ▲/▼. The Spot light-metering aiming point disappears, and the camera returns to normal light-metering.

For the DSC-P51/P31

**1** Set the mode dial to , SCN, or .

**2** Press ▶ (  ) on the control button to turn Spot light-metering on.

The Spot light-metering aiming point appears.

**3** Aim the Spot light-metering aiming point at the spot you want to shoot, then shoot your image.

## To cancel Spot light-metering

Press ▶ (  ) on the control button to turn Spot light-metering off. The Spot light-metering aiming point disappears, and the camera returns to normal light-metering.

---

## Shooting multiple frames

### – CLIP MOTION

#### Mode dial:

You can shoot a number of still images consecutively (GIF animation). Because the file size is small, these images are ideal for use on a home page, or for attaching to an e-mail message.

- Clip Motion images are restricted to color levels of 256 colors and below. This is a characteristic of GIF format recording. For this reason, the image quality of some images may deteriorate.

#### **NORMAL (160×120)**

The maximum number of frames you can shoot in one Clip Motion shot is ten. This is the best choice for use on a home page.

#### **MOBILE (120×108)**

Two frames is the maximum number that can be shot in Clip Motion in this mode.

- MOBILE mode has strict file size limits, so picture quality falls accordingly.
- For the number of images you can record using Clip Motion, see page 91.

## Before using Clip Motion

In [MOVING IMAGE] in SET UP, select [CLIP MOTION] (pages 55, 97).

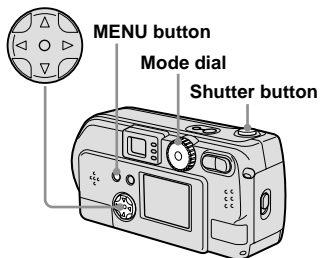

### Control button



**1** Set the mode dial to .

**2** Press the MENU button.

The menu appears.

**3** Select  (IMAGE SIZE) using , and select the desired mode using .

**4** Shoot one frame.

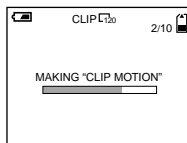

**5** Shoot the next frame.





Press the shutter once to shoot the next frame, then repeat this operation until you have shot the desired number of frames.

**6** Press the center .

All of the frames will be saved in the "Memory Stick."

- If you do not complete Step **6**, the image will not be saved in the "Memory Stick." Up to that point, the image is saved temporarily in the camera.
- In Clip Motion mode, the date and time will not be recorded.
- When you view Clip Motion images using the Index screen, the images may appear different from the actual image recorded.
- GIF files made on other cameras may not display correctly on this camera.

## To delete shot images in the midst of shooting

- 1** In Steps **4** or **5** on the previous page, press  ()  
Shot images will be played back in order, playback stops when the last image is reached.
- 2** Press the MENU button, select either [DELETE LAST], or [DELETE ALL], and press the center .
- 3** Select [OK], then press the center . If you chose [DELETE LAST] in Step **2**, repeat Steps **1** to **3** to delete the images in order, from the latest one shot.

## Shooting in Multi Burst mode

### – MULTI BURST

#### Mode dial:

Pressing the shutter once records 16 frames in a row. This is convenient for checking your form in sports, for example. You can set the interval between frames using the menu.

#### Before using Multi Burst

In [MOVING IMAGE] in SET UP, select [MULTI BURST] (page 55).



Control button

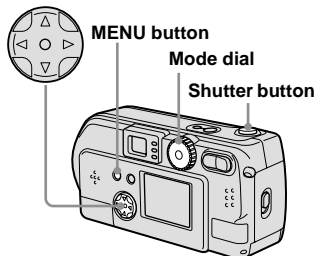

#### 1 Set the mode dial to .

#### 2 Press the MENU button.

The menu appears.

#### 3 Select (INTERVAL) using , then select the desired between-frame interval using .

You can choose the between-frame interval from among the following.  
NTSC: 1/7.5 sec., 1/15 sec., 1/30 sec.  
PAL: 1/6.3 sec., 1/12.5 sec., 1/25 sec.  
(For information on NTSC/PAL, see page 95.)



#### 4 Press the shutter.

16 frames will be recorded as one image (image size: 1280 × 960).



- When you play back images recorded with this camera in Multi Burst mode, the 16 frames are played back in order, with a fixed interval between them.
- When the images are played back on a computer, the 16 frames you shot are all displayed at the same time as part of one image.

- When Multi Burst images are played back on a camera without the Multi Burst feature, the 16 frames are all displayed at the same time, as part of one image, just as they are on a computer.
- For the number of images that can be recorded using the Multi Burst mode, see page 91.
- You cannot use the flash.
- The date/time is not inserted.



## Deleting shot images

When using this mode, you cannot delete only certain frames. When you delete images, all 16 of the frames are deleted at the same time.

- 1** Set the mode dial to .
- 2** Press the MENU button and select [DELETE] from the menu, then press the center .
- 3** Select [OK], and press the center .

All of the frames are deleted.

## Shooting still images for e-mail



### – E-MAIL

#### Mode dial: /SCN

You can shoot images and save them in a file that is small enough to attach to an e-mail message (see page 24 for available file sizes).

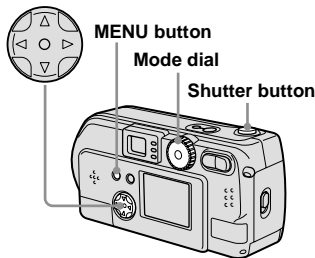
Control button



- 1** Set the mode dial to , or SCN.
- 2** Press the MENU button.  
The menu appears.
- 3** Select [MODE] (REC MODE) using , then select [E-MAIL] using .

## **4** Shoot your image.

### To return to Normal mode

In Step **3**, select [NORMAL].

- For instructions on how to attach your images to an e-mail message, refer to the Help files of the e-mail software you are using.

## Enlarging a portion of a still image

### Mode dial:

You can enlarge an image up to five times the size of the original image. You can also record the enlarged image as a new file.

### Control button

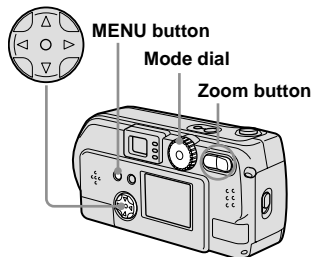

### Enlarging an image – Playback zoom

- 1** Set the mode dial to .
- 2** Display the image you want to enlarge.
- 3** Press the T zoom button to enlarge the image.
- 4** Press the control button repeatedly to select a portion of the image to enlarge.

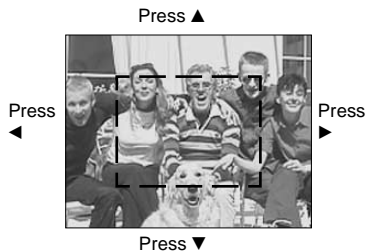

- ▲: To view a portion of the top of the image
- ▼: To view a portion of the bottom of the image
- ◀: To view a portion of the left side of the image
- ▶: To view a portion of the right side of the image

- 5** Press the T zoom button repeatedly, the portion of the image selected in Step **4** will be enlarged.



### To cancel enlarged viewing

Press the center .

- You cannot use Playback zoom for movies (MPEG MOVIE)/Clip Motion /Multi Burst features.
- If you press the W zoom button when you are viewing images that have not been enlarged, the Index screen will appear (page 37).
- The images displayed in Quick Review (page 27) can be enlarged using the procedures outlined in Steps **3** to **5**.

## Recording an enlarged image – Trimming

- 1 After you have viewed an image using playback zoom, press the **MENU** button.
- 2 Select **[TRIMMING]** using **▶**, then press the center **●**.
- 3 Select the image size using **▲**/**▼**, then press the center **●**.

The image is recorded, and the screen image returns to the size it was before enlargement.

- The trimmed image is recorded as the newest file, and the original image is retained.
- The trimmed image may suffer some deterioration in image quality
- You cannot trim an image using the 3:2 image size.

## Playing back successive images

### – SLIDE SHOW

Mode dial: **▶**

You can playback recorded images in succession, one after another. This is useful for checking your images, or for giving a presentation.

Control button

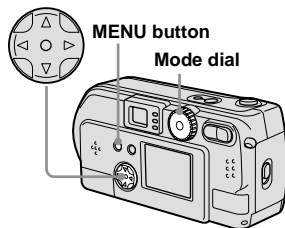

**1** Set the mode dial to **▶**.

**2** Press the **MENU** button.

The menu appears.

**3** Select **[SLIDE]** using **◀/▶**, and press the center **●**.

Select an interval from those listed below.

INTERVAL settings

3 sec/5 sec/10 sec/30 sec/1 min

REPEAT

ON: Plays the images back repeatedly.

OFF: Plays through the images one time and then stops.

**4** Select **[START]** using **▲/▼/◀/▶**, then press the center **●**.

The slide show begins.

**To cancel the slide show setting**

In Step **3**, select **[CANCEL]**, then press the center **●**.

## To stop the playback of the slide show

Press the center **●**, select [EXIT] using **▶**, then press the center **●**.

## To fast forward or to go back to a previous image during a slide show

Press the **▶** (Forward), or the **◀** (Backward).

- The interval settings are just guidelines. The actual intervals differ, based on factors like the size of the image.

## Rotating still images

### – ROTATE

Mode dial: **▶**

Images shot when holding the camera vertically can be rotated and displayed horizontally.



- 1** Set the mode dial to **▶**, and display the image you want to rotate.
- 2** Press the MENU button.  
The menu appears.
- 3** Select [ROTATE] using **◀/▶**, then press the center **●**.
- 4** Select **↶ ↷** using **▲/▼**, and rotate the image using **◀/▶**.
- 5** Select [OK] using **▲/▼**, then press the center **●**.

### To cancel the rotation

In Step **4**, select [CANCEL], then press the center **●**.

- Protected images (page 69)/movies (MPEG MOVIE)/Clip Motion/Multi Burst images cannot be rotated.
- Images shot on other cameras may not rotate correctly on this camera.
- When viewing images on a computer, the image viewing software used may not handle the rotation information correctly.

## Protecting images

### – PROTECT

#### Mode dial: ►

To prevent accidental erasure of an important image, you can protect it.

#### Control button

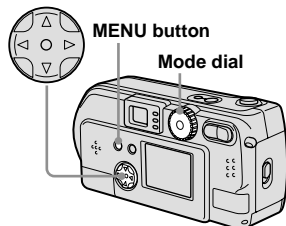

### For single images

- 1** Set the mode dial to ►.
- 2** Display the image you want to protect using ◀▶.
- 3** Press the MENU button.  
The menu appears.
- 4** Select [PROTECT] using ◀▶, then press the center ●.

The image currently being displayed is now protected, and a  (Protect) mark is shown on the screen.



### To cancel the protection

In Step **4**, press the center ● again. The  (Protect) mark disappears.

### For Index (nine-image) screen

- 1** Set the mode dial to ►, press the W zoom button once, the Index (nine-image) screen appears.
- 2** Press the MENU button.  
The menu appears.
- 3** Select [PROTECT] using ◀▶, and press the center ●.
- 4** Select [SELECT] using ◀▶, and press the center ●.  
The frame around the selected image turns green.
- 5** Select the image you want to protect using ◀▶/▲/▼, and press the center ●.

A  (Protect) mark will be attached to the selected image.



**6** To protect other images, repeat Step **5**.

**7** Press the MENU button.  
The menu appears.

**8** Select [OK] using the **▶**, then press the center **●**.  
The selected image is protected.

### To end the protection operation

Select [CANCEL] in Step **4** or select [EXIT] in Step **8**, then press the center **●**.

### To cancel the protection

In Step **5**, using the control button, select an image for which you want to cancel protection, and press the center **●**. Repeat this operation for all of the images for which you want to cancel protection. Then, press the MENU button, select [OK], and press the center **●**.

### To protect all of your images

In Step **4** select [ALL], and press the center **●**. Then select [ON], and press the center **●**.

### To remove protection from all of your images

In Step **4** select [ALL], and press the center **●**. Then select [OFF], and press the center **●**.

*For Index (triple-image) screen*

**1** Set the mode dial to **▶**, press the W zoom button twice, the Index (triple-image) screen appears.

**2** Move the image you want to protect to the center using **◀/▶**.

**3** Press the MENU button.  
The menu appears.

**4** Select [PROTECT] using **▲/▼**, and press the center **●**.

The center image is protected, and a **Ⓜ** (Protect) mark will be attached to that image.

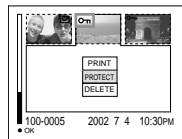

**5** To protect other images, move the image you want to protect to the center using **◀/▶**, and repeat Step **4**.

## To remove protection from previously protected images

In Step 4, select the image from which you want to remove protection, and press the center  $\bullet$ . To remove protection from all of your images, repeat this process for each of them.

## Changing image size

### – RESIZE

**Mode dial:**  $\blacktriangleright$

You can change the size of your images, and record them as new files.

You can change your images to the following sizes.

2048×1536 (DSC-P71 only), 1600×1200, 1280×960, 640×480

After the resizing is finished, the original image is retained.

### Control button

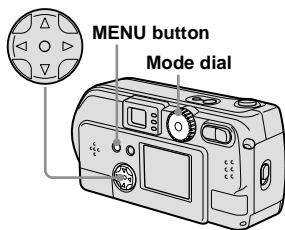

**1** Set the mode dial to  $\blacktriangleright$ .

**2** Select the image for which the size is to be changed using  $\blacktriangleleft$   $\blacktriangleright$ .

**3** Press the MENU button.

The menu appears.

**4** Select [RESIZE] using  $\blacktriangleleft$ / $\blacktriangleright$ , then press the center  $\bullet$ .

**5** Using  $\blacktriangle$ / $\blacktriangledown$ , select the new size, then press the center  $\bullet$ .

The resized image is recorded as the newest file.

### To stop the resizing process

In Step 5, select [CANCEL], then press the center  $\bullet$ .

- Movies (MPEG MOVIE)/Clip Motion/Multi Burst images cannot be resized.
- When images are resized from a smaller to a larger size, the image quality will deteriorate.
- 3:2-sized images cannot be resized.
- If you try to resize a 3:2-sized image, black bands appear at the top and bottom of the image.

## Choosing images to print

### – PRINT







#### Mode dial:

You can designate certain images to be printed.

This is convenient when you want to have images printed in shops that follow DPOF (Digital Print Order Format) specifications.

- Print marks cannot be attached to movies (MPEG MOVIE) or images recorded using Clip Motion.
- In E-MAIL mode, the Print mark will be attached to the normal size image that was recorded at the same time.
- You can attach a print mark to images shot using Multi Burst mode; all the images will be printed on one sheet divided into 16 panels.



For single images

- 1** Set the mode dial to .
- 2** Display the image you want to print using / .
- 3** Press the MENU button.  
The menu appears.
- 4** Select [PRINT] using / , then press the center .









A  (Print) mark appears on this image.



### To delete the Print mark

In Step **4**, press the center  again. The  (Print) mark disappears.

For index (nine-image) screen

- 1** Set the mode dial to  and press the W zoom button once to switch to the Index (nine-image) screen.
  - 2** Press the MENU button.  
The menu appears.
  - 3** Select [PRINT] using / , then press the center .
  - 4** Select [SELECT] using / , then press the center .
- The frame of the selected image changes to green.
- You cannot select [ALL].
- 5** Select the images you want to print using the control button, then press the center .

A  (Print) mark appears on the image.





**6** To print other images, repeat Step **5** for each of them.

**7** Press the MENU button.

The menu appears

**8** Select [OK] using **▶**, then press the center **●**.

The setting of the  (Print) mark is completed.

**To delete a  (Print) mark**

To delete a  (Print) mark, select an image using the control button, and press the center **●**.

**To delete all the Print marks attached to your images**

In Step **4**, select [ALL], then press the center **●**. Next, select [OFF], and press the center **●**.

**To cancel the Print mark**

In Step **4**, select [CANCEL], or select [EXIT] in Step **8**, then press the center **●**.

*For index (triple-image) screen*

**1** Set the mode dial to , press the W zoom button twice, and the Index (triple-image) screen appears.

**2** Display the image you want to print in the center using **◀▶**.

**3** Press the MENU button.

The menu appears.

**4** Select [PRINT] using **▲▼**, then press the center **●**.

A  (Print) mark appears on the image in the center.

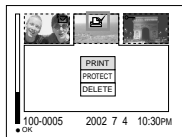

**5** To print other images, move the image you want to print to the center using **◀▶**, and repeat Step **4**.

**To delete a Print mark**

In Step **4**, press the center **●** again. The  (Print) mark disappears.

## Shooting movies

### Mode dial:

You can shoot movies. Sound cannot be recorded with movies.

### Before starting

In [MOVING IMAGE] in SET UP, select [MPEG MOVIE] (pages 55, 97).

#### Control button

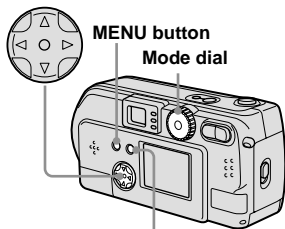





DISPLAY/LCD ON/OFF button

**1** Set the mode dial to .

**2** Press the MENU button.

The menu appears.

**3** Select  (Image size) using , and select the desired mode using /.

You can choose from 320 (HQX), 320×240, or 160×112.

See page 91 for the recording time allowed for each screen size.

**4** Press the shutter all the way down.

“RECORDING” appears on the screen and the camera starts recording the image.



- When the capacity of the “Memory Stick” is used up, recording stops.
- For details on the recording time for movies, see page 91.

**5** Press the shutter all the way down again to stop recording.

The message displayed on the screen while you are shooting

It is not written onto the image.

Each time you press the DISPLAY/LCD ON/OFF button, the status of the LCD screen changes as follows: Display OFF → LCD OFF → Display ON. See page 104 for a detailed description of the indicated items.

**To shoot close-ups (MACRO) (DSC-P71 only)**

Set the mode dial to  and follow the procedure on page 28.

**To shoot with a self-timer**

Set the mode dial to  and follow the procedure on page 29.

- You cannot use a flash.
- The date/time is not inserted.

## Viewing movies on the LCD screen

### Mode dial:

You can view movies on the LCD screen of the camera.

### 1 Set the mode dial to .

### 2 Select the desired movie using .

Movies are displayed a size smaller than still images.

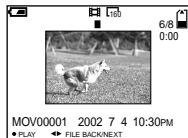

### 3 Press the center .

The movie is played back.



 (PLAYBACK) appears on the LCD screen while a movie is playing back.



### To stop playback

Press the center .

### To rewind / fast-forward

Press   while playing back a movie.

To return to the normal playback, press the center .

### High quality movies

Movies with the image size “320 (HQX)” appear on the full screen.

### Messages displayed on the screen while movies are being played back

Each time you press the DISPLAY/LCD ON/OFF button, the status of the LCD screen changes as follows: Display OFF → LCD OFF → Display ON. See page 105 for a detailed description of the indicated items.

- The procedure for viewing movies on a TV is the same as that for viewing still images (page 38).

## Deleting movies

Mode dial: ►

Control button

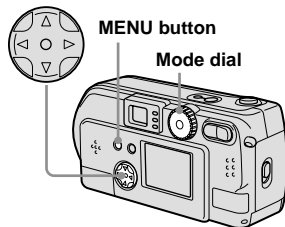

MENU button

Mode dial

### Deleting on the single screen

- 1** Set the mode dial to ►.
- 2** Select the movie you want to delete using ◀/▶.
- 3** Press the MENU button.  
The menu appears.
- 4** Select [DELETE] using ◀/▶ and press the center ●.  
The movie has not yet been deleted at this point.
- 5** Select [OK] using ▲ and press the center ●.  
“MEMORY STICK ACCESS” appears on the screen.  
The movie has been deleted when the message disappears.

### To cancel the deletion

Select [CANCEL] in Step **5**, and press the center ●.

### Deleting on the Index (nine-image) screen

- 1** Set the mode dial to ► and press the W zoom button once to display an Index (nine-image) screen.
- 2** Press the MENU button.  
The menu appears.
- 3** Select [DELETE] using ◀/▶ and press the center ●.
- 4** Select [SELECT] using ◀/▶ and press the center ●.
- 5** Select the movie you want to delete using ▲/▼/◀/▶ and press the center ●.  
The ▢ (Delete) mark appears on the selected movie.



You have not deleted the images yet at this point.

**6 Repeat Step 5 of the procedure to delete other movie.**

**7 Press the MENU button.**

The menu appears.

**8 Select [OK] using ◀/▶ and press the center ●.**

The movies are deleted when the “MEMORY STICK ACCESS” message disappears.

### To cancel the deletion

Select [CANCEL] in Step 8, and press the center ●.

### To delete all the images

Select [ALL] in Step 4, and press the center ●. To cancel the deletion, select [CANCEL] using ◀/▶ and press the center ●.

### Deleting on the Index (triple-image) screen

**1 Set the mode dial to ▶ and press the W zoom button twice to display an Index (triple-image) screen.**

**2 Show the desired movie at the center using ◀/▶.**

**3 Press the MENU button.**

The menu appears.

**4 Select [DELETE] using ▼ and press the center ●.**

The movie has not yet been deleted at this point.

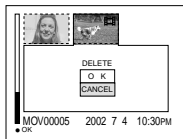

**5 Select [OK] using ▲ and press the center ●.**

The image has been deleted when the “MEMORY STICK ACCESS” message disappears.

### To cancel the deletion

Select [CANCEL] in Step 5, and press the center ●.

## Editing movies

### Mode dial:

With the mode dial, you can cut movies, or delete unnecessary portions of movies. This is the recommended mode to use when the “Memory Stick” capacity is insufficient, or when you attach movies to your e-mail messages.

### The file numbers assigned when movies are cut

The files saved after a movie cut are recognized as the latest files and are assigned new numbers. The original files are deleted, and the numbers previously assigned to those files are treated as missing numbers.

<Example> Cutting a file numbered  
MOV00002.MPG

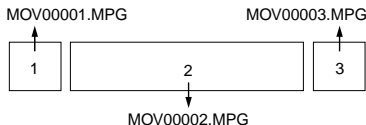

#### 1. Divide scene A.

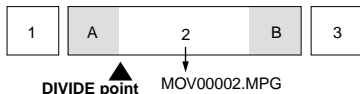

#### 2. Divide scene B.

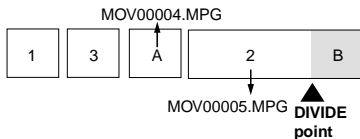

#### 3. Delete scene A and B if they are unnecessary.

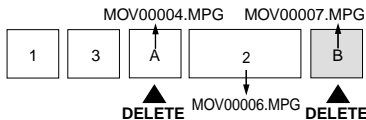



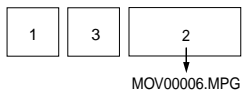



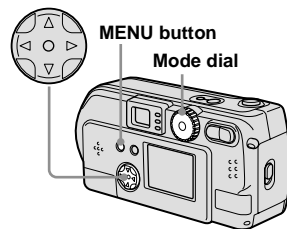

#### 4. Only the desired scenes remain.



## Cutting movies

### Control button



- 1** Set the mode dial to .
  - 2** Select the movie you want to cut using / .
  - 3** Press the MENU button.  
The menu appears.
  - 4** Select [DIVIDE] using  and press the center , and select [OK] using , then press the center .
- The playback of the movie starts.

## 5 Decide on a cutting point.

Press the center ● at the desired cutting point.

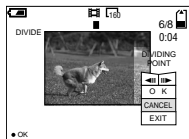

When you want to adjust the cutting point, use [◀/▶] (frame forward/rewind) and adjust the cutting point using ◀/▶. If you want to change the cutting point, select [CANCEL]. The playback of the movie starts again.

## 6 When you have decided on a cutting point, select [OK] using ▲/▼, and press the center ●.

## 7 Select [OK] using ▲ and press the center ●.

The movie is cut.

### To cancel cutting

Select [EXIT] in Step 5. The movie appears on the screen again.

- You cannot cut the following files.
  - Clip Motion files
  - Multi Burst files
  - Still image files
  - Files not long enough to cut
  - Protected movies files
- You cannot restore files once you cut them.
- The original file is deleted when you cut it.

## *Deleting unnecessary portions of a movie*

### 1 Cut an unnecessary portion of a movie (see the previous page).

### 2 Display the portion of the movie you want to delete.

### 3 Press the MENU button.

The menu appears.

### 4 Select [DELETE] using ◀/▶ and press the center ●.

### 5 Select [OK] using ▲ and press the center ●.

The movie currently displayed on the screen is deleted.

---



## Copying movies to your computer

Follow the steps below to copy movies you shot to your computer.

### Before starting

- 1 Install the USB driver.
  - 2 Insert the “Memory Stick” on which the movies are stored, into your camera. Then, turn on the camera.
  - 3 Connect the camera to your computer.
- For details, see page 44.
  - Step 1 is unnecessary when your OS is Windows XP, Mac OS 9.1, Mac OS 9.2, or Mac OS X(v10.0/v10.1).

*For Windows 98, 98SE, 2000, Me users*

- 1 **Double-click  (My Computer), then double-click  (Removable Disk).**

The contents of the “Memory Stick” inserted into your camera appear.

- This section describes an example of copying movies into the “My Documents” folder.

- 2 **Double-click  (MSSONY), then double-click  (MOML0001).**

The “MOML0001” folder opens.

- 3 **Drag and drop the movie files into the “My Documents” folder.**

The movie files are copied to the “My Documents” folder.

*For Windows XP users*

- 1 **On the Copy Wizard screen, click [Copy images to a folder on the computer]. Use the Microsoft Scanner and Camera Wizard, then click [OK].**

The “Scanner and Camera Wizard” window appears.

- 2 **Click [Next].**

All of the movies recorded in the “Memory Stick” appears on the screen.

- 3 **Click  to remove the checkmark from any movies you do not want to copy to the computer, then click [Next].**

The “Picture Name and Destination” window appears.

- 4 **Specify the movie file names to be copied and the copy destination, then click [Next].**

The copying of your movies starts. When the task is completed, the “Other Options” window appears.

- Copy movies into the “My Documents” folder.



**5 Click [Nothing. I'm finished working with these pictures], then click [Next].**

The “Completing the Scanner and Camera Wizard” window appears.

**6 Click [Finish].**

The Wizard window closes.

- When you want to continue copying other movies, disconnect the USB cable once and reconnect it. Then, follow the process from Step **1**.

*For Macintosh users*

- 1** Double-click the newly recognized icon on the desktop.  
The contents of the “Memory Stick” inserted into your camera appear.
- 2** Double-click [MSSONY].
- 3** Double-click [MOML0001].
- 4** Drag and drop the movie files to the hard disk icon.  
The movie files are copied to your hard disk.

**To copy movie files using “ImageMixer”**

You can copy movie files using the supplied “PIXELA ImageMixer for Sony” software. The operation is the same as the operation used to copy still images. For details, see the software’s help files.

## Troubleshooting

If you have trouble with your camera, try the following solutions.

- 1 Check the items on pages 82 to 88. **If the screen or the display window shows “C:□□:□□”, the self-diagnostics function is working. Please see page 90.**

- 2 Press the RESET button (pages 9, 11, 13) on the bottom of the camera, then turn on the power again. (This will erase the date/time settings, etc.)

RESET button

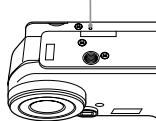















- 3 Consult your Sony dealer or local authorized Sony service facility.

## Batteries and Power



Symptom	Cause	Solution
<b>The battery remaining indicator is incorrect. Or the sufficient battery remaining indicator is displayed but the power soon runs out.</b>	<ul style="list-style-type: none"><li>• You have used the camera for a long time in an extremely hot or an extremely cold location.</li><li>• The batteries are dead (page 101).</li><li>• The batteries are discharged.</li><li>• A mismatch has occurred in the remaining battery time information.</li></ul>	— → Replace the batteries with a new one. → Install a charged batteries (page 14). → Fully charge the batteries (page 15).
<b>The battery runs down too quickly.</b>	<ul style="list-style-type: none"><li>• You are recording/playing back images in an extremely cold location.</li><li>• The batteries are not charged enough.</li><li>• The batteries are dead (page 101).</li></ul>	— → Fully charge the batteries (page 14). → Replace the batteries with a new one.
<b>The power cannot be turned on.</b>	<ul style="list-style-type: none"><li>• The batteries are not installed correctly.</li><li>• The AC power adaptor is disconnected.</li></ul>	→ Install the batteries correctly (page 17). → Connect it securely to your camera (page 19).
<b>The power turns off suddenly.</b>	<ul style="list-style-type: none"><li>• If you do not operate the camera for about 90 seconds while the power is on, the camera turns off automatically to prevent wearing down the battery (when [POWER SAVE] is [OFF], after three minutes.) (page 20).</li><li>• The batteries are discharged.</li></ul>	→ Turn on the power again (page 20).  → Replace it with a charged battery (page 14).

## Shooting Still images/Movies

Symptom	Cause	Solution
<b>The LCD screen does not light when the power is turned on.</b>	<ul style="list-style-type: none"> <li>The power was turned off with the LCD screen set to [OFF] the last time the camera was used.</li> </ul>	→ Turn the LCD screen [ON] (page 32).
<b>The subject is not visible on the LCD screen.</b>	<ul style="list-style-type: none"> <li>The mode dial is not set to  or SCN, or .</li> </ul>	→ Set it to  or SCN, or  (pages 26, 74).
<b>The image is out of focus.</b>	<ul style="list-style-type: none"> <li>The subject is too close.</li> <li>Scene selection is set to the Landscape mode.</li> <li>You have selected Focus Preset.</li> <li>Center AF is selected.</li> </ul>	→ Set the macro recording mode (DSC-P71 only) when you shoot a subject that is within 50 cm (19 <sup>11</sup> / <sub>16</sub> inches) from the lens. Make sure to place the lens farther away from the subject than the shortest shooting distance when shooting (page 28). → Cancel the setting (page 34). → Choose a focus method (page 58). → Use either the Multipoint AF (page 58) or Center AF to shoot with AF lock (page 59).
<b>Unable to zoom.</b>	<ul style="list-style-type: none"> <li>You cannot zoom while shooting a movie (MPEG MOVIE) (DSC-P71/P31 only).</li> </ul>	—
<b>Digital zoom does not function.</b>	<ul style="list-style-type: none"> <li>You cannot zoom while shooting a movie (MPEG MOVIE).</li> <li>[DIGITAL ZOOM] is set to [OFF] in SET UP (DSC-P71/P51 only).</li> <li>The LCD screen is OFF.</li> </ul>	— → Change it to [ON] (pages 55, 97). → Turn it ON (page 32).
<b>The image is too dark.</b>	<ul style="list-style-type: none"> <li>You are shooting a subject with a light source behind the subject.</li> <li>The brightness of the LCD screen is too low.</li> <li>The POWER SAVE is set to ON.</li> </ul>	→ Adjust the exposure (page 56). → Adjust the brightness of the LCD screen in the SET UP settings (pages 55, 98). → Turn the POWER SAVE to OFF (page 16).
<b>The image is too bright.</b>	<ul style="list-style-type: none"> <li>You are shooting under a spotlight in a dark location, like stage lighting.</li> <li>The LCD is too bright.</li> </ul>	→ Adjust the exposure (page 56). → Adjust the [LCD BACKLIGHT] in the SET UP settings (pages 55, 98).
<b>The image is monochrome (black and white).</b>	<ul style="list-style-type: none"> <li>[P. EFFECT] is set to [B&amp;W] mode.</li> </ul>	→ Cancel [B&W] mode (page 60).

Symptom	Cause	Solution
<b>Vertical streaks appear when you are shooting a very bright subject.</b>	<ul style="list-style-type: none"> <li>The smear phenomenon is occurring.</li> </ul>	→ This is not a malfunction.
<b>You cannot shoot images.</b>	<ul style="list-style-type: none"> <li>No “Memory Stick” has been inserted.</li> <li>The capacity of the “Memory Stick” is full.</li> <li>The write-protect tab on the “Memory Stick” is set to the LOCK position.</li> <li>You cannot shoot while the flash is charging.</li> <li>The mode dial is not set to  or SCN while shooting a still image.</li> <li>The mode dial is not set to  when shooting a moving picture.</li> </ul>	→ Insert a “Memory Stick” (page 23). → Delete the images saved in the “Memory Stick,” or format it. → Change the “Memory Stick.” → Change the LOCK position (page 100).  — → Set it to  or SCN (page 26).  → Set it to  (page 74).
<b>Cannot record images with the flash.</b>	<ul style="list-style-type: none"> <li>The mode dial is set to , SET UP, or .</li> <li>The flash is set to  (No flash).</li> <li>When recording still images, Scene Selection is set to Twilight mode.</li> </ul>	→ Set it to a setting other than  , SET UP, or  (page 30). → Set the flash to “AUTO” (no indicator) or  (forced flash) (page 30). → Cancel the setting (page 34).
<b>The eyes of the subject come out red.</b>	—	→ Set the red eye reduction mode (page 31).
<b>The date and time are recorded incorrectly.</b>	<ul style="list-style-type: none"> <li>The date and time are not set correctly.</li> </ul>	→ Set the correct date and time. (page 21)

## Viewing images

Symptom	Cause	Solution
The image cannot be played back.	<ul style="list-style-type: none"><li>• The mode dial is not set to .</li><li>• When you load an image modified using the retouch software on your computer or directly on the camera, the image format differs so the “FILE ERROR” message may appear and you may be unable to open the file.</li></ul>	→ Set the mode dial to  (page 36). —
Images are coarse right after being played back.	—	→ This is not a malfunction.
The images cannot be played back on a TV.	<ul style="list-style-type: none"><li>• The [VIDEO OUT] setting for your camera in SET UP is incorrect.</li><li>• The connection is not correct.</li></ul>	→ Set it to [NTSC] or [PAL] (pages 55, 98). → Check the connection (page 38).
The images cannot be played back on a personal computer.	—	→ See page 86.

## Deleting/Editing an image

Symptom	Cause	Solution
Your camera cannot delete an image.	<ul style="list-style-type: none"><li>• The image is protected.</li><li>• The write-protect tab on the “Memory Stick” is set to the LOCK position.</li></ul>	→ Cancel the protection (page 69). → Change the LOCK position (page 100).
You have deleted the image by mistake.	<ul style="list-style-type: none"><li>• Once you have deleted a file, you cannot restore it.</li></ul>	→ The write-protect tab on the “Memory Stick” will prevent you from deleting images by mistake (page 69).
The resizing function does not work.	<ul style="list-style-type: none"><li>• Movies (MPEG MOVIE)/Clip Motion/Multi Burst images cannot be resized.</li></ul>	—
You cannot display a print mark.	<ul style="list-style-type: none"><li>• You cannot display print marks on Clip Motion images and MPEG movies.</li></ul>	—

## Computers

Symptom	Cause	Solution
<b>You do not know the OS of your computer.</b>	—	→ Check “Recommended computer environment” (page 44).
<b>You cannot install the USB driver.</b>	—	→ In Windows 2000, log on as Administrators (page 45).
<b>Your personal computer does not recognize your camera.</b>	<ul style="list-style-type: none"> <li>• The camera is turned off.</li> <li>• The battery level is too low.</li> <li>• You are not using the supplied USB cable.</li> <li>• The USB cable is not connected securely.</li> </ul> <ul style="list-style-type: none"> <li>• [USB CONNECT] is set to [PTP] in the SET UP settings.</li> <li>• The USB connectors on your personal computer are connected to other equipment besides the keyboard, the mouse, and your camera.</li> <li>• The USB driver is not installed.</li> <li>• Your computer does not properly recognize the device because you connected the camera and your computer with the USB cable before you installed the “USB Driver” from the supplied CD-ROM.</li> </ul>	<ul style="list-style-type: none"> <li>→ Turn on the camera (page 20).</li> <li>→ Use the AC power adaptor (not supplied) (page 19).</li> <li>→ Use the supplied USB cable (page 47).</li> <li>→ Disconnect the USB cable, and connect it again securely. Make sure that “USB MODE” is displayed on the LCD screen (page 47).</li> <li>→ Set it to [NORMAL] (pages 55, 98).</li> </ul> <ul style="list-style-type: none"> <li>→ Disconnect the USB cables except for those connected to the keyboard, the mouse, and your camera.</li> </ul> <ul style="list-style-type: none"> <li>→ Install the USB driver (page 45).</li> <li>→ Delete the erroneously recognized device from your computer, then install the USB driver (pages 45, 49).</li> </ul>
<b>You cannot copy images.</b>	<ul style="list-style-type: none"> <li>• The camera is not correctly connected to your computer.</li> <li>• The copy procedure differs depending on your OS.</li> </ul> <p>—</p>	<ul style="list-style-type: none"> <li>→ Connect the camera and your computer correctly using the USB cable.</li> <li>→ Follow the copy procedure that your OS suggests (pages 48, 49, 54).</li> <li>→ If you are using the “PIXELA ImageMixer for Sony” software, click on HELP.</li> </ul>
<b>The image cannot be played back on a computer.</b>	—	<ul style="list-style-type: none"> <li>→ If you are using the “PIXELA ImageMixer for Sony” software, click on HELP.</li> <li>→ Consult the computer or software manufacturer.</li> </ul>

## Computers (continued)

Symptom	Cause	Solution
The image is affected by noise when you play back an image on a computer.	<ul style="list-style-type: none"><li>You are playing back the file directly from the “Memory Stick.”</li></ul>	→ Copy the file to the hard disk of the computer and then play the file back from the hard disk (page 80).
You cannot print an image.	—	→ Check the printer settings. → Click on HELP files for the “PIXELA ImageMixer for Sony” software.

## “Memory Stick”

Symptom	Cause	Solution
You cannot insert a “Memory Stick.”	<ul style="list-style-type: none"><li>You are inserting it backwards.</li></ul>	→ Insert it from the right side (page 23).
You cannot record on a “Memory Stick.”	<ul style="list-style-type: none"><li>The write-protect tab on the “Memory Stick” is set to the LOCK position.</li><li>The “Memory Stick” is full.</li></ul>	→ Change the LOCK position (page 100). → Delete unnecessary images (page 39).
You cannot format a “Memory Stick.”	<ul style="list-style-type: none"><li>The write-protect tab on the “Memory Stick” is set to the LOCK position.</li></ul>	→ Change the LOCK position (page 100).
You have formatted a “Memory Stick” by mistake.	<ul style="list-style-type: none"><li>All the images on the “Memory Stick” are deleted by formatting, and they cannot be recovered.</li></ul>	→ Set the “Memory Stick” write-protect tab to the LOCK position (page 100) to prevent formatting it by mistake.

## Others



Symptom	Cause	Solution
The camera doesn't work, no operations can be performed.	<ul style="list-style-type: none"><li>The battery level is low or zero (The  indicator appears.).</li><li>The AC power adaptor is not connected securely.</li><li>The built-in microcomputer is not working properly.</li></ul>	→ Charge the battery (page 14). → Connect it securely to the DC IN jack of your camera and to a wall outlet (mains) (page 19). → Disconnect, and then, after one minute, reconnect all power sources. Then turn the power on and check that the camera works properly.

Symptom	Cause	Solution
<b>The power is on, but the camera does not work.</b>	<ul style="list-style-type: none"> <li>The built-in microcomputer is not working properly.</li> </ul>	→ Remove, and then, after one minute, reinstall the battery. If this doesn't work, press the RESET button on the bottom of the camera with pointed object, then turn the power on again. (This will clear the date/time settings, etc.)
<b>You cannot identify the indicator on the LCD screen.</b>	—	→ Check the indicator (pages 103 to 105).
<b>The lens does not move when you turn off the camera. (DSC-P71 only)</b>	<ul style="list-style-type: none"> <li>The battery pack is discharged.</li> </ul>	→ Replace it with a charged battery or use the AC power adaptor (not supplied) (pages 14, 17, 19).
<b>The lens gets fogged.</b>	<ul style="list-style-type: none"> <li>Condensation is occurring.</li> </ul>	→ Leave the camera for about an hour and then try to use it again (page 99).



## Warnings and messages

The following messages appear on the LCD screen.

Message	Meaning/ Corrective Action
<b>NO MEMORY STICK</b>	<ul style="list-style-type: none"><li>• Insert a “Memory Stick” (page 23).</li></ul>
<b>SYSTEM ERROR</b>	<ul style="list-style-type: none"><li>• Turn the power off and on again (page 20).</li></ul>
<b>MEMORY STICK ERROR</b>	<ul style="list-style-type: none"><li>• The inserted “Memory Stick” cannot be used in your camera (page 100).</li><li>• The “Memory Stick” is damaged, or the terminal section of the “Memory Stick” is dirty.</li><li>• Insert the “Memory Stick” correctly (page 23).</li></ul>
<b>FORMAT ERROR</b>	<ul style="list-style-type: none"><li>• The “Memory Stick” format failed. Format the “Memory Stick” again (page 43).</li></ul>
<b>MEMORY STICK LOCKED</b>	<ul style="list-style-type: none"><li>• The write-protect tab on the “Memory Stick” is set to the LOCK position. Move it to the recording/UNLOCK position (page 100).</li></ul>
<b>NO MEMORY SPACE</b>	<ul style="list-style-type: none"><li>• The capacity of the “Memory Stick” is full. You cannot record images. Delete unnecessary images (page 39).</li></ul>
<b>NO FILE</b>	<ul style="list-style-type: none"><li>• No images have been recorded on the “Memory Stick.”</li></ul>
<b>FILE ERROR</b>	<ul style="list-style-type: none"><li>• An error occurred while playing back the image.</li></ul>
<b>FILE PROTECT</b>	<ul style="list-style-type: none"><li>• The image is protected against erasure.</li></ul>
<b>FOLDER ERROR</b>	<ul style="list-style-type: none"><li>• A folder with the same name already exists on the “Memory Stick.”</li></ul>
<b>IMAGE SIZE OVER</b>	<ul style="list-style-type: none"><li>• You are playing back an image of a size that cannot be played back on your camera.</li></ul>
<b>INVALID OPERATION</b>	<ul style="list-style-type: none"><li>• You are playing back a file that was created on equipment other than this camera.</li></ul>
	<ul style="list-style-type: none"><li>• The battery level is low or zero. Charge the battery (page 14). Depending on the conditions of use or the type of battery, the indicator may flash even though there are still 5 to 10 minutes of remaining battery time left.</li></ul>
<b>CAN NOT DIVIDE</b>	<ul style="list-style-type: none"><li>• The file is not long enough to be divided.</li><li>• The file is not a moving image.</li></ul>
	<ul style="list-style-type: none"><li>• You are not holding the camera steadily enough. Use the flash, mount the camera on a tripod, or otherwise secure the camera in place.</li></ul>
<b>TURN THE POWER OFF AND ON AGAIN</b>	<ul style="list-style-type: none"><li>• A problem with the lens caused an error.</li></ul>

## Self-Diagnostics Display

– When a message starting with a letter of the alphabet appears

Your camera has a self-diagnostics display. This function displays the condition of the camera on the LCD screen using a combination of a letter and four numerical digits. If this occurs, check the following code chart and take the corresponding countermeasure. The last two digits (indicated by □□) will differ depending on the state of the camera.

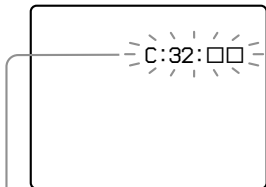

Self-diagnostics display

Code	Cause	Countermeasure
<b>C:32:</b> □□	There is trouble with your camera's hardware, or with the zoom function.	• Turn the power off and on again (page 20).
<b>C:13:</b> □□	The camera cannot read or write data on the "Memory Stick."	• Re-insert the "Memory Stick" several times.
	An unformatted "Memory Stick" has been inserted.	• Format the "Memory Stick"(page 43).
	The inserted "Memory Stick" cannot be used with your camera, or the data is damaged.	• Insert a new "Memory Stick" (page 23).
<b>E:61:</b> □□ <b>E:91:</b> □□ <b>E:92:</b> □□	A camera malfunction that you cannot reverse has occurred.	• Press the RESET button (pages 9, 11, 13) on the bottom of the camera, then turn the power on again.

If your camera is not still functioning well after trying the countermeasure a couple of times, contact your nearest Sony service station and inform them of the 5-digit displayed code.

Example: E:61:10

## The number of images that can be saved/shooting time

The number of images that can be saved and the shooting time are different, depending on the capacity of the “Memory Stick,” the image size, and the image quality. Refer to the following charts when you choose a “Memory Stick.”

- The number of images is listed in FINE (STANDARD) order.
- The values for the number of images that can be saved and the shooting time may vary, depending on the shooting conditions.
- For normal shooting times and numbers of images that can be saved, see page 25.

### E-mail

(Units: images)

	8M	16M	32M	64M	128M
2048×1536 (DSC-P71)	4 (8)	9 (17)	20 (36)	40 (72)	80 (146)
2048 (3:2) (DSC-P71)	4 (8)	9 (17)	20 (36)	40 (72)	80 (146)
1600×1200	8 (14)	16 (28)	32 (59)	64 (118)	128 (236)
1600 (3:2) (DSC-P51/ P31)	8 (14)	16 (28)	32 (59)	64 (118)	128 (236)
1280×960	12 (21)	24 (42)	48 (88)	96 (176)	192 (352)
640×480	43 (95)	87 (192)	177 (390)	357 (786)	714 (1572)

### Clip Motion

(Units: images)

	8M	16M	32M	64M	128M
Normal	40	80	160	320	640
Mobile	300	450	900	1800	3600

Normal: When 10 frames are shot

Mobile: When 2 frames are shot

### MPEG movies

(Units: seconds)

	8M	16M	32M	64M	128M
320 (HQX)	20	40	85	170	340
320×240	80	160	340	680	1360
160×112	320	640	1300	2700	5400

### Multi Burst













(Units: images)

	8M	16M	32M	64M	128M
1280×960	12 (22)	24 (44)	50 (93)	100 (186)	200 (372)





## Menu items

Menu items that can be changed differ depending on the position of the mode dial. The LCD screen shows only the items you can operate based on the current position of the mode dial. Factory settings are indicated with ■.





### When the mode dial is set to , SCN

Item	Setting	Description
SCN	■  /  / 	Selects one of the scene selections. (In  mode, this setting cannot be carried out.) (page 34)
 (EV)	+2.0EV / +1.7EV / +1.3EV / +1.0EV / +0.7EV / +0.3EV / ■0EV / -0.3EV / -0.7EV / -1.0EV / -1.3EV / -1.7EV / -2.0EV	Adjusts the exposure (page 56).
 (FOCUS)	∞ / 7.0 m / 3.0 m / 1.0 m / 0.5 m / CENTER AF / ■ MULTI AF	Chooses the auto focus method. Sets the focus distance using focus preset (pages 58, 60)
WB (WHITE BAL)	 /  /  /  / ■AUTO	Sets the white balance (page 61)
 (SPOT METER) (DSC-P71 only)	ON / ■ OFF	To match the exposure to the subject you want to shoot (page 61).
ISO	400 / 200 / 100 / ■AUTO	Selects the ISO sensitivity. When recording under dark conditions or recording a fast-moving subject, use a high-number setting. When recording high-quality images, use a low-number setting (except when the Mode dial is set to SCN).
 (IMAGE SIZE) (DSC-P71)	■2048×1536 / 2048 (3:2) / 1600×1200 / 1280×960 / 640×480	Selects the image size used when shooting still pictures (page 24).
 (IMAGE SIZE) (DSC-P51/P31)	■1600×1200 / 1600 (3:2) / 1280×960 / 640×480	Selects the image size used when shooting still pictures (page 24)









## When the mode dial is set to , SCN. (continued)

Item	Setting	Description
 (P.QUALITY)	■ FINE / STANDARD	Records images with fine image quality mode / Records images in the standard image quality mode (page 24).
MODE(REC MODE)	E-MAIL ■ NORMAL	– Records a small-size (320×240) JPEG file in addition to the selected image size (page 65). – Records an image using the normal recording mode.
 (FLASH LEVEL)	HIGH ■ NORMAL LOW	– Makes the flash level higher than normal. – Normal setting. – Makes the flash level lower than normal.
PFX (P.EFFECT)	SOLARIZE/B&W/SEPIA/ NEG.ART/■ OFF	Sets the special effects for the image (page 60).
 (SHARPNESS)	+2 / +1 / ■ 0 / -1 / -2	Adjusts the sharpness of the image. The  indicator appears (except when the setting is 0).

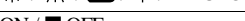







## When the mode dial is set to (MOVING IMAGE is set to MPEG MOVIE in the SET UP settings.)

Item	Setting	Description
 (EV)	+2.0EV / +1.7EV / +1.3EV / +1.0EV / +0.7EV / +0.3EV / ■ 0EV / -0.3EV / -0.7EV / -1.0EV / -1.3EV / -1.7EV / -2.0EV	Adjusts the exposure (page 56).
 (FOCUS)	∞ / 7.0 m / 3.0 m / 1.0 m / 0.5 m / CENTER AF / ■ MULTI AF	Chooses the auto focus method, set the focus preset distance (pages 58, 60).
WB (WHITE BAL)	 / ■ AUTO	Sets the white balance (page 57).
 (SPOT METER) (DSC-P71 only)	ON / ■ OFF	To match the exposure to the subject you want to shoot (page 61).
 (IMAGE SIZE)	320(HQX) / 320×240 / ■ 160×112	Selects the MPEG image size when recording movies (page 74).
PFX (P.EFFECT)	SOLARIZE/B&W/SEPIA/ NEG.ART/■ OFF	Sets the special effects for the image (page 60).



When the mode dial is set to  (MOVING IMAGE is set to CLIP MOTION in the SET UP settings.)

Item	Setting	Description
 (EV)	+2.0EV / +1.7EV / +1.3EV / +1.0EV / +0.7EV / +0.3EV / ■ 0EV / -0.3EV / -0.7EV / -1.0EV / -1.3EV / -1.7EV / -2.0EV	Adjusts the exposure (page 56).
 (FOCUS)	∞ / 7.0 m / 3.0 m / 1.0 m / 0.5 m / CENTER AF / ■ MULTI AF	Chooses the auto focus method, set the focus preset distance (pages 58, 60).
WB (WHITE BAL)	 /  /  / ■ AUTO	Sets the white balance (page 57).
 (SPOT METER) (DSC-P71 only)	ON / ■ OFF	To match the exposure to the subject you want to shoot (page 61).
 (IMAGE SIZE)	■ NORMAL / MOBILE	Selects the Clip Motion image size (page 62).
 ± (FLASH LEVEL)	HIGH ■ NORMAL LOW	Makes the flash level higher than normal. Normal setting. Makes the flash level lower than normal.
PFX (P.EFFECT)	SOLARIZE/B&W/SEPIA/ NEG.ART/■OFF	Sets the special effects for the image (page 60).
 (SHARPNESS)	+2/ +1/ ■ 0/ -1/ -2	Adjusts the sharpness of the image. The  indicator appears (except when the setting is 0).

## When the mode dial is set to (when MOVING IMAGE in SET UP is set to Multi Burst)

Item	Setting	Description
 (EV)	+2.0EV / +1.7EV / +1.3EV / +1.0EV / +0.7EV / +0.3EV / ■ 0EV / -0.3EV / -0.7EV / -1.0EV / -1.3EV / -1.7EV / -2.0EV	Adjusts the exposure (page 56).
 (FOCUS)	∞ / 7.0 m / 3.0 m / 1.0 m / 0.5 m / CENTER AF / ■ MULTI AF	Chooses the auto focus method, set the prefocus distance (pages 58, 60).
WB (WHITE BAL)	 / ■ AUTO	Sets the white balance (page 57).
 (SPOT METER) (DSC-P71 only)	ON / ■ OFF	To match the exposure to the subject you want to shoot (page 61).
 (INTERVAL)	■ 1/30 / 1/15 / 1/7.5 (NTSC) ■ 1/25 / 1/12.5 / 1/6.3 (PAL)	– In NTSC mode, choose the Multi Burst between-frame shutter interval. – In PAL mode, choose the Multi Burst between-frame shutter interval. * The choices of between-frame shutter interval change depending on the setting of the [VIDEO OUT] item in SET UP (page 98).
 (P.QUALITY)	■ FINE / STANDARD	Records images with fine/high image quality. / Records images in the standard image quality mode (page 24).
PFX (P.EFFECT)	SOLARIZE/B&W/SEPIA/ NEG.ART/■ OFF	Sets the special effects for the image (page 60).
 (SHARPNESS)	+2/ +1/ ■ 0/ -1/ -2	Adjusts the sharpness of the image. The  indicator appears (except when the setting is 0).

## When the mode dial is set to

Item	Setting	Description
<b>DELETE</b>	OK CANCEL	Deletes the displayed image (page 39). Cancels deleting of the image.
<b>PROTECT</b>	—	Protects images against accidental erasure (page 69).
<b>PRINT</b>	—	Selects still images you want to print. (page 72).
<b>SLIDE</b>	INTERVAL  REPEAT START CANCEL	<ul style="list-style-type: none"> <li>– Sets the slide show interval. (For single images only.)  <ul style="list-style-type: none"> <li>■ 3 sec/ 5sec/ 10sec/ 30sec/ 1min</li> </ul> </li> <li>– Plays the slide show over and over again  <ul style="list-style-type: none"> <li>■ ON/OFF</li> </ul> </li> <li>– Starts the slide show</li> <li>– Cancels the settings and execution of the slide show</li> </ul>
<b>RESIZE</b>	2048×1536 (DSC-P71) / 1600×1200/1280×960/ 640×480/ CANCEL	Changes the recorded image size (page 71). (For single images only.)
<b>ROTATE</b>	 (counter-clockwise) /  (clockwise) / OK / CANCEL	Rotates the still image (page 68). (For single images only.)
<b>DIVIDE</b>	OK / CANCEL	Divides a moving image (page 78). (For single images only.)



## SET UP items

Set the mode dial to SET UP. The setup screen appears.

Factory settings are indicated with ■.

When shooting movies/Clip Motion/Multi Burst, the date and time cannot be inserted in the image. Also, the date and time will not be displayed when shooting. The date and time will be displayed when the image is played back.

### CAMERA

Item	Setting	Description
MOVING IMAGE	■MPEG MOVIE / CLIP MOTION / MULTI BURST	Selects the shooting mode (pages 55, 62, 64, 74).
DATE/TIME	DAY & TIME / DATE / ■OFF	Selects whether to insert the date and time into the image (page 32).
DIGITAL ZOOM (DSC-P71/P51)	■ON / OFF	Selects whether to use the digital zoom (page 28).
RED EYE REDUCTION	ON / ■OFF	Reduces the red-eye phenomenon when using a flash (page 31).
AF ILLUMINATOR	■AUTO / OFF	Selects whether to emit an AF assist light in the dark. Helps when it is hard to focus on the subject under dark lighting (page 31).

### SETUP 1

Item	Setting	Description
FORMAT	OK / CANCEL	Formats the “Memory Stick”. Please note that formatting erases all the information recorded on a “Memory Stick”, including even erasure protected images (page 43).
FILE NUMBER	■ SERIES RESET	– Assigns numbers to files in sequence even if the “Memory Stick” is changed. – Resets the file numbering and starts from 0001 each time the “Memory Stick” is changed.
言語 / LANGUAGE	■ ENGLISH 日本語 / JPN	– Displays the menu items, warnings and messages in English. – Displays the menu items, warnings and messages in Japanese.
CLOCK SET	OK / CANCEL	Sets the date and time (page 21).

**SETUP 2**

Item	Setting	Description
<b>LCD BRIGHTNESS</b>	BRIGHT/ ■NORMAL/ DARK	Selects the LCD brightness. This has no effect on the recorded images.
<b>LCD BACKLIGHT</b>	BRIGHT/ ■NORMAL	Selects the brightness of the LCD backlight. Selecting “BRIGHT” makes the screen bright and easy to see when using the camera outdoors or in other bright locations, but also uses up the battery charge faster. Displayed only when you are using your camera with the batteries and the POWER FUNCTION is set to OFF.
<b>BEEP</b>	SHUTTER ■ ON OFF	<ul style="list-style-type: none"><li>– Turns on the shutter sound when you release the shutter button.</li><li>– Turns on the beep/shutter sound when you press the control button/ release the shutter button.</li><li>– Turns off the beep/shutter sound.</li></ul>
<b>VIDEO OUT</b>	■ NTSC PAL	<ul style="list-style-type: none"><li>– Sets the video output signal to [NTSC] mode (Japan, USA).</li><li>– Sets the video output signal to [PAL] mode (Europe).</li></ul>
<b>USB CONNECT</b>	PTP/■NORMAL	Switches the USB mode (page 44).
<b>POWER SAVE (DSC-P71)</b>	■ ON / OFF	Selects whether to use the [POWER SAVE] mode (page 16).

---

## Precautions

### Cleaning

#### Cleaning the LCD screen

Clean the screen surface with an LCD cleaning kit (not supplied) to remove fingerprints, dust, etc.

#### Cleaning the lens

Wipe the lens with a soft cloth to remove fingerprints, dust, etc.

#### Cleaning the camera surface

Clean the camera surface with a soft cloth slightly moistened with water, then wipe the surface with a dry cloth. Do not use any type of solvent such as thinner, alcohol or benzene as this may damage the finish or the casing.

#### Note on operating temperature

The camera is designed for use within a temperature range of 0° to 40° (32°F to 104°F). Shooting in extremely cold or hot locations that exceed this range is not recommended.

### On moisture condensation

If the camera is brought directly from a cold to a warm location, or is placed in a very damp room, moisture may condense inside or outside the camera. This moisture condensation may cause a malfunction of the camera.

#### Moisture condensation occurs easily when:

- The camera is brought from a cold location such as a ski slope into a warmly heated room.
- The camera is taken from an air-conditioned room or car interior to the hot outdoors, etc.

#### To prevent moisture condensation

When bringing the camera from a cold place to a warm place, seal the camera in a plastic bag and leave it in the new location for about an hour. Remove the plastic bag when the camera has adapted to the new temperature.

#### If moisture condensation occurs

Turn off the camera and wait about an hour for the moisture to evaporate. Note that if you attempt to shoot with moisture remaining inside the lens, you will be unable to record clear images.

### The internal rechargeable button battery

This camera has an internal rechargeable button battery for maintaining the date and time and other settings regardless of whether the power is on or off.

This rechargeable button battery is continually charged as long as you are using the camera. However, if you use the camera for only short periods it discharges gradually, and if you do not use the camera at all for about one month it becomes completely discharged. In this case, be sure to charge this rechargeable button battery before using the camera.

Note that even if this rechargeable button battery is not charged, you can still use the camera as long as you do not record the date and time.

#### Charging the battery

Connect the camera to a wall outlet (mains) using the AC power adapter or install a charged battery pack, and leave the camera for 24 hours or more with the POWER button set to OFF.

## The “Memory Stick”

“Memory Stick” is a new compact, portable and versatile IC recording medium with a data capacity that exceeds the capacity of a floppy disk.

There are two types of “Memory Stick”: an ordinary “Memory Stick” and a “MagicGate Memory Stick” that are equipped with the MagicGate copyright protection technology. You can use both types of “Memory Stick” with your camera. However, because your camera does not support the MagicGate standards, data recorded with your camera is not subject to MagicGate\* copyright protection.

\* MagicGate is copyright protection technology that uses encryption technology.

- You cannot record or delete images when the write-protect tab is set to LOCK. The position or the shape of the write-protect tab may differ depending on the “Memory Stick” you use.

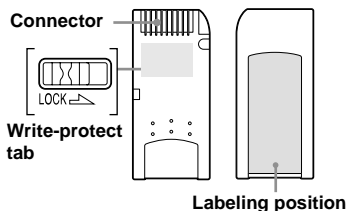

- Do not remove the “Memory Stick” while reading or writing data.
- Data may be damaged in a location subject to the effects of static electricity or noise.
- Do not attach any other material than the supplied label on the labeling position.
- When you carry or store the “Memory Stick,” put it in the case supplied with it.
- Do not touch the terminals of a “Memory Stick” with your hand or a metal object.
- Do not strike, bend or drop a “Memory Stick.”
- Do not disassemble or modify a “Memory Stick.”
- Do not expose the “Memory Stick” to water.

## The nickel hydride batteries

### Effective use of the battery

- Battery performance decreases in low-temperature surroundings, and the battery life is shortened under such circumstances. To use the battery longer, we recommend you keep the battery in a pocket close to your body to warm it, and insert it in your camera just before you start shooting.
- If you use the LCD screen or shoot a lot using the zoom, the battery power will be used up faster.
- We recommend having spare batteries handy for two or three times the expected shooting time, and try test shooting before the actually using the camera.
- Do not expose the battery to water. The battery is not water-resistant.

## Battery life

- The battery life is limited. Battery capacity decreases little by little as you use it more and more, and as time passes. When the battery operating time seems to have been considerably shortened, a probable cause is that the battery pack has reached the end of its life.
- The battery life varies depending on storage, operating conditions, and environment, and is different for each battery pack.

## Specifications

### System

Image device **DSC-P71**  
8.93mm (1/1.8 type) color  
CCD  
Primary color filter  
**DSC-P51**  
6.64 mm(1/2.7 type) color  
CCD  
Primary color filter  
**DSC-P31**  
6.64 mm(1/2.7 type) color  
CCD

Total pixels number of camera  
**DSC-P71**  
Approx. 3 300 000 pixels  
**DSC-P51**  
Approx. 2 100 000 pixels  
**DSC-P31**  
Approx. 2 100 000 pixels

Lens  
**DSC-P71**  
3× zoom lens  
f=8 to 24.0 mm (35 mm camera  
conversion: 39 to 117mm)  
F2.8~5.3  
**DSC-P51**  
2× zoom lens  
f=6.3 to 12.6 mm (35 mm camera  
conversion: 41 to 82 mm), F3.8  
**DSC-P31**  
Single focal lens  
f=5mm (35 mm camera conversion:  
33 mm), F2.8  
Primary color filter

## Camera

Effective pixels number of camera

**DSC-P71**  
Approx. 3 210 000 pixels  
**DSC-P51**  
Approx. 1 980 000 pixels  
**DSC-P31**  
Approx. 1 980 000 pixels

Exposure control

Automatic,  
Scene Selection (3 mode)

White balance Automatic, Daylight, Cloudy,  
Fluorescent, Incandescent

Data formats Moving images: MPEG1  
Still images: JPEG, GIF (for Clip  
Motion)

Recording media

“Memory Stick”

Flash

Recommended distance  
**DSC-P71**:0.5 to 3.8 m (1.6 to 12.5  
ft) (W)  
0.5 to 2.5 m (1.6 to 8.2 ft) (T)  
**DSC-P51**:0.4 to 2.8 m (1.3 to 9.2 ft)  
(W/T)  
**DSC-P31**:0.4 to 3.8 m (1.3 to 12.5  
ft)  
(when ISO sensitivity is set to Auto)

### Output connectors

VIDEO OUT jack

Minijack  
1 Vp-p, 75 ohm, unbalanced, sync  
negative

USB jack

mini-B

## LCD screen

LCD panel used

### DSC-P71

3.8 cm (1.5 type) TFT drive

### DSC-P51

4.0 cm (1.6 type) TFT drive

### DSC-P31

4.0 cm (1.6 type) TFT drive

Total number of dots

### DSC-P71

123 200 (560×220) dots

### DSC-P51

61 600 (280×220) dots

### DSC-P31

61 600 (280×220) dots

## Power, etc.

Power AA nickel hydride batteries (2)

2.4 V

AC-LS1 AC power adaptor  
(not supplied), 4.2 V

Power consumption (when recording)

### DSC-P71

2.1W

### DSC-P51

1.7W

### DSC-P31

1.7W

Operating temperature range

0° to +40°C (+32° to +104°F)

Storage temperature range

-20° to +60°C (-4° to +140°F)

Dimensions

### DSC-P71

124.9 × 58 × 43.6 mm ( $5 \times 2 \frac{3}{8} \times 1 \frac{3}{4}$  inches)

### DSC-P51

126.9 × 58 × 47 mm ( $5 \times 2 \frac{3}{8} \times 1 \frac{7}{8}$  inches)

### DSC-P31

106 × 58 × 39.5 mm ( $4 \frac{1}{4} \times 2 \frac{3}{8} \times 1 \frac{9}{16}$  inches)  
(W/H/D, protruding portions not included)

Mass

### DSC-P71

284 g (10 oz) (camera, two batteries, "Memory Stick" and wrist strap included)

### DSC-P51

275 g (10 oz) (camera, two batteries, "Memory Stick" and wrist strap included)

### DSC-P31

231 g (8 oz) (camera, two batteries, "Memory Stick" and wrist strap included)

## BC-CS1 Ni-MH battery charger

Power requirements

AC 100 to 240V 50/60Hz  
2.2 W

Output voltage

DC 1.8V 180/110 mA × 2

Dimensions

70 × 29 × 74 mm ( $2 \frac{7}{8} \times 1 \frac{3}{16} \times 3$  inches) (W/H/D)

Mass

Approx. 70g (2 oz)

Operating temperature range

0° to +40°C (32° to +104°F)

## AC-LS1 AC power adaptor (not supplied)

Power requirements

AC 100 – 240 V, 50/60 Hz

Rated output voltage

DC 4.2 V, 1.5 A

External dimensions

105 × 36 × 56 mm ( $4 \frac{1}{4} \times 1 \frac{7}{16} \times 2 \frac{1}{4}$  inches) (W/H/D, protruding parts not included)

Mass

Approx. 180 g (6 oz)  
(adaptor only)

Operating temperature range

0° to +40°C (32° to +104°F)

Storage temperature range

-20° to +60°C (-4° to +140°F)

## Accessories

- Video connector cable (1)
- R6 (size AA) Ni-MH batteries (2)
- Ni-MH Battery charger (1)
- Power cord (mains lead) (1)
- USB cable (1)
- Wrist strap
- "Memory Stick" (8MB for DSC-P31, 16MB for DSC-P71/P51) (1)
- CD-ROM (USB driver: SPVD-008) (1)
- Operating Instructions (1)

Design and specifications are subject to change without notice.

## The LCD screen

### For shooting still images

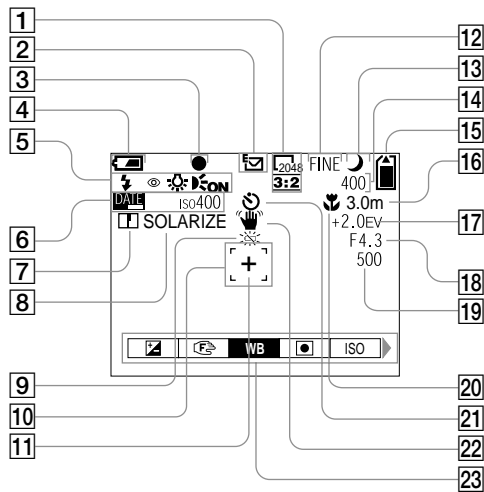

1 Image size indicator (24, 25)

2 Recording mode indicator (65)

3 AE/AF LOCK indicator (26, 59)

4 Remaining battery indicator display (16)

5 Flash mode (30)/Red-eye reduction (31)/White balance indicator (57)/AF illuminator indicator (31, 97)

6 Date/time indicator (32)  
ISO sensitivity (92)

7 Sharpness indicator (93, 94, 95)

8 Picture effect indicator (60)

9 Low battery warning (16)

10 AF range finder (58)

11 Spot light-meter aiming point (61)

12 Image quality indicator (24, 25)

13 Scene selection mode indicator

14 Remaining images indicator (25)  
Self-diagnostics display (90)

15 Remaining "Memory Stick" capacity indicator (25)

16 Center AF indicator (58)/  
Focus preset value (60)

17 EV adjustment indicator (56)

18 Iris value indicator

19 Shutter speed indicator

20 Macro (DSC-P71) (28)

21 Self-timer display (29)

22 Vibration warning indicator (89)



23 Menu/Guide menu (55)

- When you press the MENU button, Menu/Guide menu is toggled between display/don't display.
-  (SPOT METER) is not displayed on the menu of the DSC-P51/P31 (page 61).

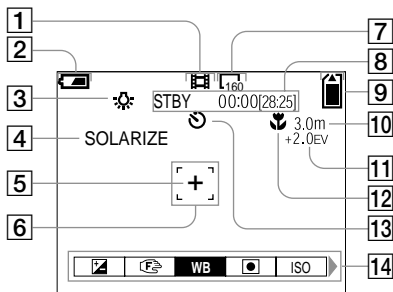
## For shooting movies



- 1 **Recording mode indicator** (74)
- 2 **Remaining battery indicator display** (16)
- 3 **White balance indicator** (57)
- 4 **Picture effect indicator** (60)
- 5 **Spot light-metering aiming point** (61)
- 6 **AF range finder** (58)
- 7 **Image size indicator** (74)
- 8 **Recording time remaining indicator (Maximum recording time) indicator** (18)/ **Self-diagnostics display** (90)
- 9 **Remaining "Memory Stick" capacity indicator** (25)

- 10 **Center AF**  **indicator** (58)/ **Focus preset value** (60)
- 11 **EV adjustment indicator** (56)
- 12 **Macro**  **(DSC-P71)** (28)
- 13 **Self-timer indicator** (29)
- 14 **Menu/Guide menu** (55)
  - When you press the MENU button, Menu/Guide menu is toggled between display/don't display
  -  (SPOT METER) is not displayed on the menu of the DSC-P51/P31 (page 61).

The page numbers in parentheses indicate the location of additional important information.



## For still image playback

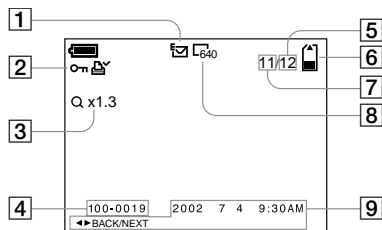

- 1 Recording mode indicator (65)
- 2 Protection indicator (69)/Print mark indicator (72)
- 3 Zoom indicator (66)
- 4 File name (52)
- 5 Number of pages recorded in “Memory Stick” (25)
- 6 Remaining “Memory Stick” capacity indicator (25)
- 7 Image number (25)
- 8 Image size indicator (24, 25)
- 9 Date/time recorded indicator (32)/Menu/Guide menu (55)

## For movie playback

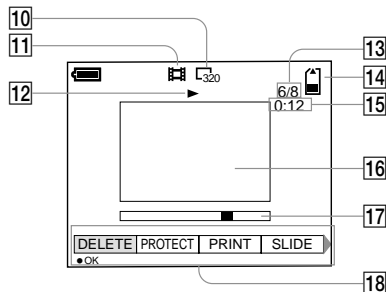

- 10 Image size indicator (75)
- 11 Recording mode indicator (74, 75)
- 12 Playback indicator (75)
- 13 Image number/Number of images recorded in the “Memory Stick” (75)
- 14 Remaining “Memory Stick” capacity (75)
- 15 Counter (75)
- 16 Playback screen (75)
- 17 Playback bar (75)
- 18 Menu/Guide menu (55)

The page numbers in parentheses indicate the location of additional important information.

# Index

## A

Access lamp .....	23
AE/AF lock .....	26, 59
AE/AF lock lamp .....	9
AF illuminator .....	12, 31, 97
AF lock .....	59
AF lock lamp (green) .....	11, 13
AF mode .....	26
Auto Power Off feature .....	20

## B

Battery	
Battery life .....	18
Charging time .....	15
Preparing batteries .....	14
Remaining indicator .....	16
Beep/shutter sound .....	98

## C

CD-ROM .....	45
Charging	
Charging the batteries .....	14
Charging time .....	15
Computer	
Copying images .....	48, 54
Copying movies to your computer .....	80
USB cable .....	47
USB driver .....	45
Control button .....	20
Copying images .....	48, 54

## D

DC plug .....	19
Deleting images .....	39
DIVIDE .....	78

## E

Editing still images	
Print mark .....	72
Protect .....	69
Resize .....	71
E-MAIL .....	65
EV adjustment .....	56
Exposure	
EV adjustment .....	56

## F

File	
File names .....	51
Image file storage destinations .....	51
Finder .....	32
Flash	
FLASH LEVEL .....	93, 94
RED EYE REDUCTION .....	31
Selecting a flash mode .....	30
Focus	
AE/AF lock lamp .....	9
AF lock .....	59
Focus preset .....	60
Shooting (using auto adjustment mode) .....	26
FORMAT .....	43

## G

GIF .....	52
-----------	----

## I

Image	
Copying images .....	48
File names .....	51
Image file storage destinations .....	51
Image quality .....	24
Image size .....	24, 25, 91
Index .....	36
Installation	
USB driver .....	45
ISO .....	92

## J

JPG .....	52
-----------	----

## L

LCD screen display	
DISPLAY/LCD ON/OFF .....	32
LCD brightness .....	98

## M

Memory Stick	
Formatting a “Memory Stick” .....	43
Inserting a “Memory Stick” .....	23
Number of shooting images .....	25
The number of images that can be saved/ shooting time .....	91
Menu	
Changing menu .....	55
Mode dial .....	9, 11, 13, 55
Movie	
Continuous shooting .....	18
Copying movies to your computer .....	80

Cutting movies .....	78	Setting		Shooting close-ups (Macro) .....	28
Deleting movies .....	76	Changing menu .....	55	Shooting with the date and time inserted ....	32
Shooting movies .....	74	Date and time .....	21	Spot light-metering .....	61
Viewing movies .....	75	Image quality .....	24	The number of images that can be saved ....	91
MPG .....	52	Image size .....	24, 25, 91	The number of images that can be shot .....	18
<b>N</b>		SET UP .....	55	Using auto adjustment mode .....	26
NR slow shutter .....	35	Setting the date and time .....	21	Using the self-timer .....	29
NTSC .....	98	SHARPNESS .....	93	WHITE BALANCE .....	57
<b>O</b>		Shooting close-ups (Macro) .....	28	Zoom .....	28
On moisture condensation .....	99	Shooting mode			
<b>P</b>		Clip Motion .....	62	<b>T</b>	
PAL .....	98	E-MAIL .....	65	Trimming .....	67
Picture effect .....	60	MPEG MOVIE .....	74	TV set .....	38
Power		Shooting (using auto adjustment mode) ....	26	<b>U</b>	
An external power source .....	19	Shooting in Multi Burst mode .....	64	USB .....	45, 47
batteries .....	14	Shooting with the date and time inserted .....	32	Using your camera abroad .....	19
Inserting the batteries .....	17	Still image playback			
ON/OFF .....	20	Index (9 images) screen .....	37	<b>V</b>	
Precautions .....	99	Quick Review .....	27	Video connecting cable .....	38
<b>R</b>		ROTATE .....	68	Viewing single images .....	36
RED EYE REDUCTION .....	31, 97	Slide show .....	67	<b>W</b>	
RESET button .....	9, 11, 13, 90	Using the zoom feature .....	28	Warnings and messages .....	89
<b>S</b>		Viewing images on a TV screen .....	38	<b>Z</b>	
SCENE SELECTION .....	34	Viewing single images .....	36	Zoom	
SCN .....	34	Viewing the images on your computer .	53, 54	Digital zoom .....	28
Self-timer .....	29	Still image shooting		Playback zoom .....	66
Set up		AE/AF lock lamp .....	9	Using the zoom feature .....	28
SET UP .....	55	AF mode .....	26		
		EV adjustment .....	56		
		Image quality .....	24		
		Image size .....	24		
		Number of shooting images .....	25		
		Picture effect .....	60		
		SCENE SELECTION .....	34		
		Selecting a flash mode .....	30		



Printed on recycled paper using  
VOC (Volatile Organic  
Compound)-free vegetable oil  
based ink.

<http://www.sony.net/>  
Sony Corporation Printed in Japan