

# Camera Operations Guide

Read this first

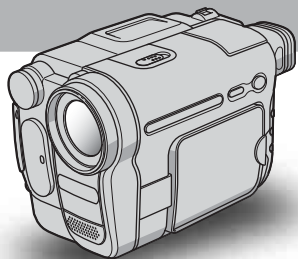

*Video Camera Recorder/Digital Video Camera Recorder*

**HANDYCAM**

**video Hi8**

*CCD-TRV138/TRV338*

**Digital 8**

*DCR-TRV280*

# Read this first

Before operating the unit, please read this manual thoroughly, and retain it for future reference.

## WARNING

**To prevent fire or shock hazard, do not expose the unit to rain or moisture.**

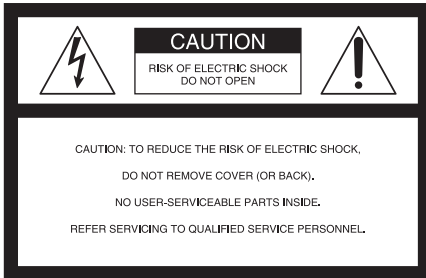

This symbol is intended to alert the user to the presence of uninsulated “dangerous voltage” within the product’s enclosure that may be of sufficient magnitude to constitute a risk of electric shock to persons.



This symbol is intended to alert the user to the presence of important operating and maintenance (servicing) instructions in the literature accompanying the appliance.

### ⚡ Notice

If static electricity or electromagnetism causes data transfer to discontinue midway (fail), restart the application or disconnect and connect the communication cable (USB, etc.) again.

## For customers in the U.S.A. and CANADA

### RECYCLING LITHIUM-ION BATTERIES

Lithium-Ion batteries are recyclable.

You can help preserve our environment by returning your used rechargeable batteries to the collection and recycling location nearest you.

For more information regarding recycling of rechargeable batteries, call toll free 1-800-822- 8837, or visit <http://www.rbrc.org/>



Caution: Do not handle damaged or leaking Lithium-Ion batteries.

## For customers in the U.S.A.

If you have any questions about this product, you may call:

Sony Customer Information Center 1-800-222-SONY (7669).

The number below is for the FCC related matters only. Regulatory Information

### Declaration of Conformity

Trade Name: SONY

Model No.: DCR-TRV280

Responsible Party: Sony Electronics Inc.

Address: 16450 W. Bernardo Dr, San Diego, CA 92127 U.S.A.

Telephone No.: 858-942-2230

This device complies with Part 15 of the FCC Rules.

Operation is subject to the following two conditions:

(1) This device may not cause harmful interference, and (2) this device must accept any interference received, including interference that may cause undesired operation.

### Owner’s Record

The model and serial numbers are located on the bottom. Record the serial number in the space provided below. Refer to these numbers whenever you call upon your Sony dealer regarding this product.

Model No. \_\_\_\_\_-TRV \_\_\_\_\_

Serial No. \_\_\_\_\_

Model No.AC- \_\_\_\_\_

Serial No. \_\_\_\_\_

## CAUTION

You are cautioned that any changes or modifications not expressly approved in this manual could void your authority to operate this equipment.

### ⚡ Notes:

- This equipment has been tested and found to comply with the limits for a Class B digital device, pursuant to Part 15 of the FCC Rules.

These limits are designed to provide reasonable protection against harmful interference in a residential installation. This equipment generates, uses, and can radiate radio frequency energy and, if not installed and used in accordance with the instructions, may cause harmful interference to radio communications. However, there is no guarantee that interference will not occur in a particular installation. If this equipment does cause harmful interference to radio or television reception, which can be determined by turning the equipment off and on, the user is encouraged to try to correct the interference by one or more of the following measures:

- Reorient or relocate the receiving antenna.
- Increase the separation between the equipment and receiver.
- Connect the equipment into an outlet on a circuit different from that to which the receiver is connected.
- Consult the dealer or an experienced radio/TV technician for help.



The supplied interface cable must be used with the equipment in order to comply with the limits for a digital device pursuant to Subpart B of Part 15 of FCC Rules.

- This product contains mercury. Disposal of this product may be regulated if sold in the United States. For disposal or recycling information, please contact your local authorities or the Electronics Industries Alliance (<http://www.eiae.org>).

---

## Notes on use

### Note on a cassette tape

You can use standard 8 mm  and Hi8 , Digital8  video cassettes on your camcorder. See page 95 for details.

### Notes on recording

- Before starting to record, test the recording function to make sure the picture and sound are recorded without any problems.
- Compensation for the contents of recordings cannot be provided, even if recording or playback is not possible due to a malfunction of the camcorder, etc.

- TV color systems differ depending on the country/region. To view your recordings on a TV, you need an NTSC system-based TV.
- Television programs, films, video tapes, and other materials may be copyrighted. Unauthorized recording of such materials may be contrary to the copyright laws.



### Notes on the LCD panel, viewfinder, and lens

- The LCD screen and the viewfinder are manufactured using extremely high-precision technology, so over 99.99% of the pixels are operational for effective use. However, there may be some tiny black points and/or bright points (white, red, blue, or green in color) that appear constantly on the LCD screen and the viewfinder. These points are normal results of the manufacturing process and do not affect the recording in any way.
- Exposing the LCD screen, the viewfinder, or the lens to direct sunlight for long periods of time may cause malfunctions. Be careful when placing the camera near a window or outdoors.
- Do not aim at the sun. Doing so might cause your camcorder to malfunction. Take pictures of the sun only in low light conditions, such as at dusk.

### Note on connecting other device

Before connecting your camcorder to other device such as a VCR or a computer with an USB or i.LINK cable, be sure to insert the connector plug in the proper direction. If you insert the connector plug forcibly in the wrong direction, the terminal may be damaged. This may cause a malfunction of your camcorder.

### Notes on using this manual

- The images of the LCD screen and the viewfinder used on this manual are captured using a digital still camera, and thus may appear different from what you see.
- In this instruction manual, each model is indicated as follows.  
CCD-TRV138:  TRV138  
CCD-TRV338:  TRV338  
DCR-TRV280:  TRV280  
Instructions with no specific model names are for all models.  
Instructions with specific model names are for the indicated models only.  
Before you start reading this manual, check the model name of your camcorder.
- The on-screen displays in each local language are used in illustrating the operating procedures. Change the screen language before using your camcorder if necessary (p. 19).

→ continued

- The illustrations used on this manual are based on the model DCR-TRV280.
- The screens shown in this manual are from a Windows XP computer. The screens may vary depending on the OS.

- Turn the SEL/PUSH EXEC dial to select desired item, then press the dial to decide.

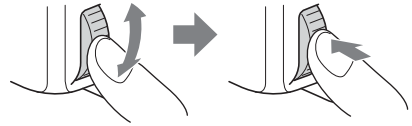

**Notes on using the camcorder**

- Hold your camcorder correctly.

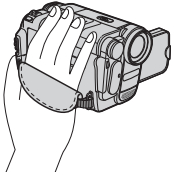

- To ensure a good grip, fasten the grip belt as shown in the following illustration.

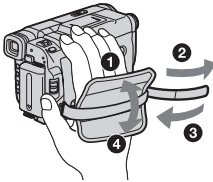

- Be careful not to press buttons on the LCD frame accidentally when you open or close the LCD panel, or when you adjust the angle of the LCD panel.
- Do not hold the camcorder by the following parts.

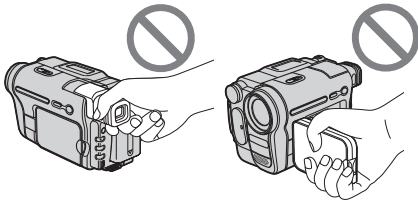

Viewfinder

LCD panel

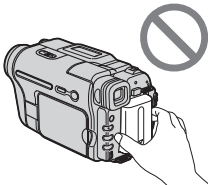

Battery pack

# Table of Contents

CCD-TRV138: **Hi8** TRV138 CCD-TRV338: **Hi8** TRV338  
DCR-TRV280: **D**TRV280

Read this first .....	2
-----------------------	---

---

## Quick Start Guide

Recording movies .....	8
Recording/Playing back with ease .....	10

---

## Getting started

Step 1: Checking supplied items .....	11
Step 2: Charging the battery pack.....	12
Using an outside power source .....	15
Step 3: Turning the power on.....	15
Step 4: Adjusting the LCD panel and viewfinder.....	16
Adjusting the LCD panel .....	16
Adjusting the viewfinder .....	16
Step 5: Setting the date and time.....	17
Step 6: Inserting a cassette tape.....	18
Step 7: Setting the screen language .....	19

---

## Recording

Recording movies .....	21
Recording for a longer time .....	23
Using zoom .....	23
Using the built-in light .....	23
Recording in mirror mode .....	24
Superimposing the date and time on pictures ( <b>Hi8</b> TRV138/338) .....	25
Recording still images – Tape photo recording ( <b>D</b> TRV280).....	25
Recording with ease – Easy Handycam .....	26
Adjusting the exposure.....	27
Adjusting the exposure for backlit subjects .....	27
Adjusting the exposure manually .....	28
Recording in dark places – NightShot plus .....	28
Adjusting the focus manually .....	29
Recording a picture using various effects .....	30
Fading in and out of a scene – FADER .....	30

→ *continued*

Superimposing a title.....	31
Searching for the last scene of the most recent recording – END SEARCH .....	33

---









## **Playback**

Viewing pictures recorded on a tape.....	34
Playing back in various modes .....	35
Playing back with ease – Easy Handycam .....	36
Various playback functions .....	37
Displaying the screen indicators .....	37
Displaying the date/time and camera settings data – Data code (▶TRV280) .....	37
Playing the picture on a TV .....	39

## Advanced operations



---

### Customizing Your Camcorder

Changing the menu settings .....	41
Using the  (MANUAL SET) menu – PROGRAM AE/P EFFECT, etc. ....	42
Using the  (CAMERA SET) menu – 16:9 WIDE/STEADYSHOT, etc. ....	45
Using the  (PLAYER SET)/  (VCR SET) menu – HiFi SOUND/EDIT, etc. ....	49
Using the  (LCD SET) menu – LCD B.L./LCD COLOR, etc. ....	51
Using the  (TAPE SET) menu – FRAME REC/INT.REC, etc. ....	52
Using the  (SETUP MENU) – CLOCK SET/USB STREAM/  LANGUAGE, etc. ....	55
Using the  (OTHERS) menu – WORLD TIME/VIDEO EDIT, etc. ....	57





---

### Dubbing/Editing

Connecting to a VCR .....	59
Dubbing to another tape .....	61
Dubbing a tape easily – Easy Dubbing (  TRV138/338) .....	62
Recording pictures from a VCR (  TRV280) .....	66
Dubbing selected scenes from a tape – Digital program editing (  TRV280) .....	67

---

### Using with your computer

Features (  TRV280) .....	72
Installing the software and “First Step Guide” on a computer (  TRV280) .....	74
Using “First Step Guide” (  TRV280) .....	78
Creating a DVD (Direct Access to “Click to DVD”) (  TRV280) .....	79

---

### Troubleshooting

Troubleshooting .....	82
Warning indicators and messages .....	92

---

### Additional Information

Using your camcorder abroad .....	94
Usable cassette tapes .....	95
About the “InfoLITHIUM” battery pack .....	96
About i.LINK .....	97
Maintenance and precautions .....	98
Specification .....	101

---

### Quick Reference

Identifying parts and controls .....	104
Index .....	109

For  TRV280:

Two operating instructions are supplied with your camcorder:

- Camera Operations Guide (This manual)
- “First Step Guide” for using the supplied applications (included in the supplied CD-ROM)



## Quick Start Guide

# Recording movies

### 1 Attach the charged battery pack to the camcorder.

To charge the battery, see page 12.

① Lift up the viewfinder.

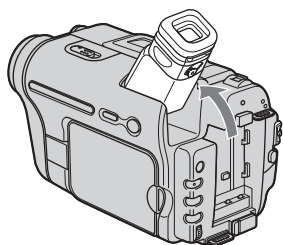

② Slide the battery pack in the direction of the arrow until it clicks.

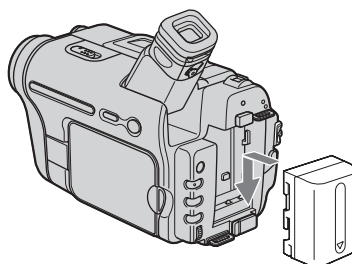

### 2 Insert a cassette into the camcorder.

① Slide the **OPEN/EJECT** lever in the direction of the arrow and open the lid until it clicks.

The cassette compartment comes out automatically.

**OPEN/EJECT** lever

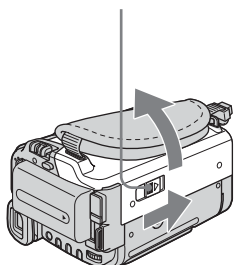

② Insert the cassette with its window-side facing up, then push the center of the back of the cassette.

Window-side

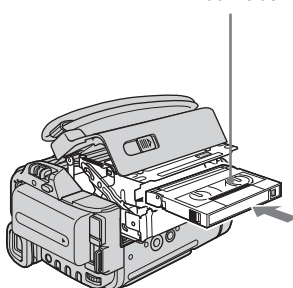

③ Press **PUSH**.

Close the cassette lid after the cassette compartment slides back in by itself.

**PUSH**

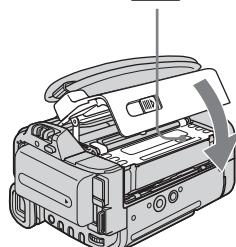



### 3 Start recording while checking the subject on the LCD screen.

The date and time is not set up in the default setting. To set the date and time, see page 17.

#### 1 Remove the lens cap.

Lens cap is not attached when you purchase your camcorder (p. 104).

#### 2 Press OPEN and open the LCD panel.

#### 3 While pressing the green button, slide the POWER switch down to light up the CAMERA lamp.

The power turns on.

#### 4 Press REC START/STOP.

Recording starts. To change to standby mode, press START/STOP again. You can also use REC START/STOP of the LCD panel.

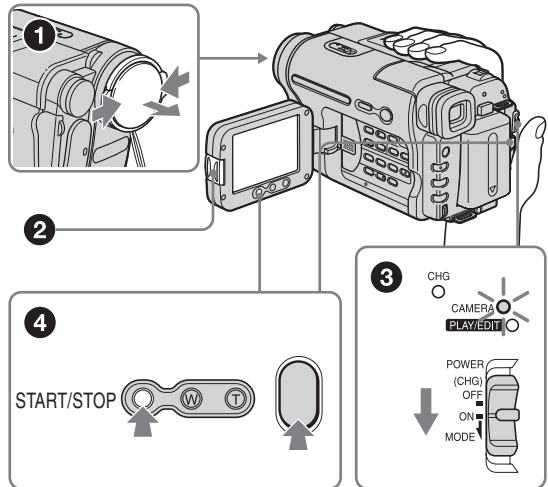

### 4 View the recorded picture on the LCD screen.

#### 1 Slide the POWER switch repeatedly until the PLAY/EDIT lamp lights up.

#### 2 Press ⏮ (rewind).

#### 3 Press ⏪ (play) to start the playback.

To stop, press ⏹.

To turn off the power, slide the POWER switch up to (CHG) OFF.

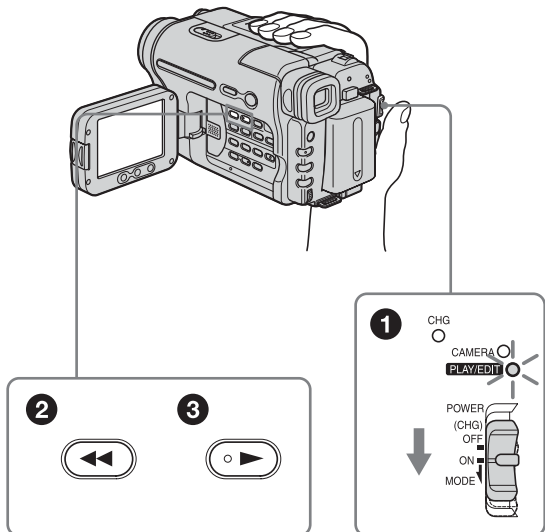

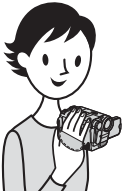

# Recording/Playing back with ease

By switching to Easy Handycam operation, recording/playback operation becomes even easier.

Easy Handycam operation allows easy recording/playback for even first time users by providing only the basic functions for recording/playback.

## Press EASY when recording/ playing back.

EASY lights up in blue (1) and screen font size increases (2) during Easy Handycam operation.

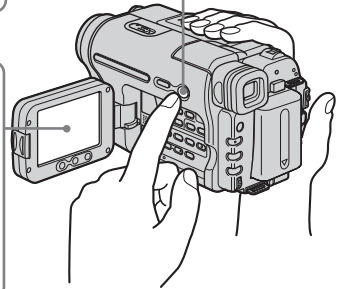
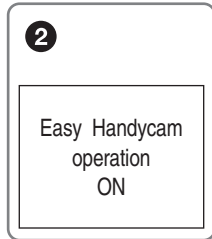
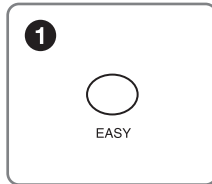

For details, see instructions for each operation.  
See page 26 for recording, page 36 for playback.

# Step 1: Checking supplied items

Make sure you have following items supplied with your camcorder.

The number in parentheses indicates the number of that item supplied.

## AC Adaptor (1)

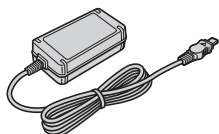

## Power cord (1)



## Lens cap (1)

See page 104 on how to attach the lens cap.



## Shoulder strap (1)

See page 107 on how to attach the shoulder strap.

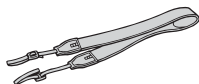

## A/V connecting cable (1)

Monaural: (Hi8 TRV138/338)



Stereo: (Hi8 TRV280)



## USB cable (1)

(Hi8 TRV280)



## Rechargeable battery pack NP-FM30 (1)

## CD-ROM "Picture Package Ver.1.5" (1)

(Hi8 TRV280)

## Camera Operations Guide (This manual)

(1)

## Step 2: Charging the battery pack

You can charge the battery by attaching the “InfoLITHIUM” battery pack (M series) to your camcorder.

### Notes

- You cannot use batteries other than the “InfoLITHIUM” battery pack (M series) (p. 96).
- Do not short-circuit the DC plug of the AC Adaptor or battery terminals with any metallic objects. This may cause a malfunction.
- Use a nearby wall outlet when using the AC Adaptor. Disconnect the AC Adaptor from the wall outlet immediately if any malfunction occurs.
- Do not install the appliance in a confined space, such as a bookcase or build-in cabinet.

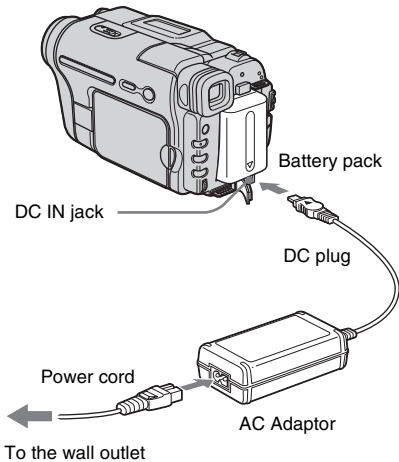

**1** Lift up the viewfinder.

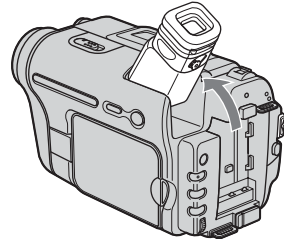

**2** Attach the battery pack by sliding it in the direction of the arrow until it clicks.

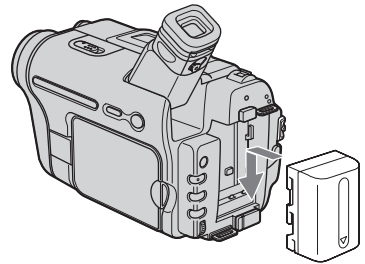

**3** With the ▲ mark on the DC plug facing up, connect the AC Adaptor to the DC IN jack on your camcorder.

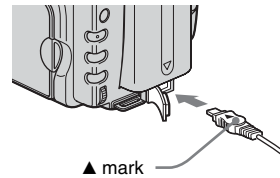

**4** Connect the power cord to the AC Adaptor.

**5** Connect the power cord to the wall outlet.

## 6 Slide the POWER switch up to (CHG) OFF.

The CHG (charge) lamp lights up and charging starts.

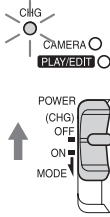

## To check the remaining battery – Battery Info

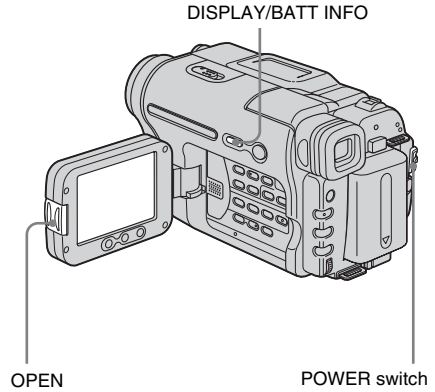

## After charging the battery

The CHG (charge) lamp turns off when the battery is fully charged. Disconnect the AC Adaptor from the DC IN jack.

## To remove the battery pack

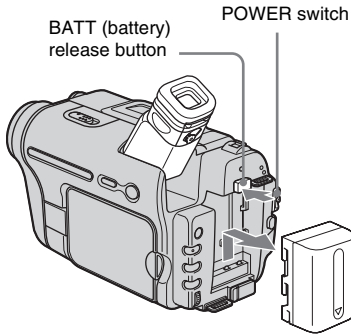

- 1 Lift up the viewfinder.
- 2 Set the POWER switch to (CHG) OFF.
- 3 Slide the battery pack out in the direction of the arrow while pressing the BATT (battery) release button down.

### Note

- If you do not use the battery pack for a long time, use up the battery pack completely before storing it. See page 96 about storage of the battery pack.

You can check the battery's current charge level and its current remaining recording time both during charging or when the power is turned off.

- 1 Set the POWER switch to (CHG) OFF.
- 2 Press OPEN and open the LCD panel.
- 3 Press DISPLAY/BATT INFO.

The battery information appears for about 7 seconds.

Keep the button pressed to view it for about 20 seconds.

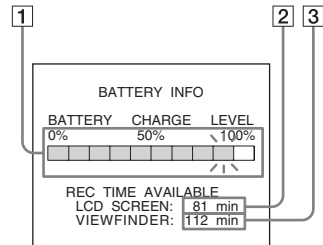

- 1 Battery charge level: Displays approximate remaining amount of power left in the battery pack.
- 2 Approximate possible recording time using the LCD panel.
- 3 Approximate possible recording time using the viewfinder.

## Charging time

Approximate number of minutes required when you fully charge a fully discharged battery pack

→ continued

at 25°C (77°F). (10 – 30°C (50 – 86°F) recommended.)

Battery pack	
NP-FM30 (supplied)	145
NP-FM50	150
NP-QM71D	260
NP-QM91D	360

### Recording time when recording with the LCD screen on

Approximate number of minutes available when you use a fully charged battery pack at 25°C (77°F).

For **Hi8** TRV138/338:

Battery pack	Continuous recording time	Typical* recording time
NP-FM30 (supplied)	115	55
NP-FM50	185	90
NP-QM71D	445	220
NP-QM91D	670	335

For **Hi8** TRV280:

Battery pack	Continuous recording time	Typical* recording time
NP-FM30 (supplied)	90	50
NP-FM50	145	80
NP-QM71D	355	220
NP-QM91D	535	300

### Recording time when recording with the viewfinder

Approximate number of minutes available when you use a fully charged battery pack at 25°C (77°F).

For **Hi8** TRV138/338:

Battery pack	Continuous recording time	Typical* recording time
NP-FM30 (supplied)	175	85

Battery pack	Continuous recording time	Typical* recording time
NP-FM50	280	135
NP-QM71D	675	330
NP-QM91D	1010	495

For **Hi8** TRV280:

Battery pack	Continuous recording time	Typical* recording time
NP-FM30 (supplied)	125	65
NP-FM50	200	105
NP-QM71D	485	255
NP-QM91D	725	385

\* Approximate number of minutes when recording while you repeatedly record, start/stop, slide the POWER switch to change the power mode, and zoom. The actual battery life may be shorter.

### Playing time

Approximate number of minutes available when you use a fully charged battery pack at 25°C (77°F).

For **Hi8** TRV138/338:

Battery pack	LCD panel opened	LCD panel closed
NP-FM30 (supplied)	115	185
NP-FM50	185	295
NP-QM71D	445	715
NP-QM91D	670	1070

For **Hi8** TRV280:

Battery pack	LCD panel opened	LCD panel closed
NP-FM30 (supplied)	100	150
NP-FM50	160	240
NP-QM71D	390	580
NP-QM91D	585	865

### Notes

- The power will not be supplied from the battery pack when the AC Adaptor is connected to the DC IN jack of your camcorder, even if its power cord is disconnected from the wall outlet.
- The recording and playback time will be shorter when you use your camcorder in low temperature.
- The CHG (charge) lamp flashes during charging, or the battery information will not be correctly displayed in following conditions.
  - The battery pack is not attached correctly.
  - The battery pack is damaged.
  - The battery pack is fully discharged. (For Battery information only.)

## Using an outside power source

You can use the AC Adaptor as the power source when you do not want the battery to run out. While you are using the AC Adaptor, the battery pack will not lose its charge even when it is attached to your camcorder.

### PRECAUTION

Even if your camcorder is turned off, AC power (house current) is still supplied to it while connected to the wall outlet via the AC Adaptor.

**Connect your camcorder as shown in “Charging the battery pack” (p. 12).**

## Step 3: Turning the power on

You need to slide the POWER switch repeatedly to select the desired power mode to record or play.

When using this camcorder for the first time, the [CLOCK SET] screen appears (p. 17).

**While pressing the green button, slide the POWER switch down.**

The power turns on.

To enter the recording or playing mode, slide the switch repeatedly until the respective lamp for the desired power mode lights up.

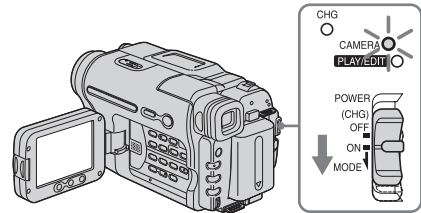

- CAMERA mode: To record on a tape.
- PLAY/EDIT mode: To play or edit pictures on a tape.

### To turn off the power

Slide the POWER switch up to (CHG) OFF.

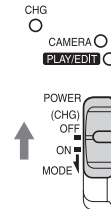

## Step 4: Adjusting the LCD panel and viewfinder

### Adjusting the LCD panel

You can adjust the angle and brightness of the LCD panel to meet various recording situations.

Even when there are obstructions between you and the subject, you can check the subject on the LCD screen during recording by adjusting the angle of the LCD panel.

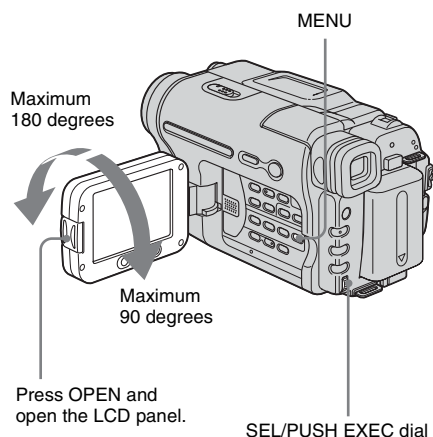



Open the LCD panel 90 degrees to the camcorder, then rotate it to the desired position.

### To adjust the brightness of the LCD screen

- 1 Press MENU.
- 2 Turn the SEL/PUSH EXEC dial to select  (LCD SET), then press the dial.

- 3 Turn the SEL/PUSH EXEC dial to select [LCD BRIGHT], then press the dial (p. 51).
- 4 Adjust the brightness of the LCD screen with the SEL/PUSH EXEC dial, then press the dial.
- 5 Press MENU.

### Tips

- If you rotate the LCD panel 180 degrees to the lens side, you can close the LCD panel with the LCD screen facing out.
- If you are using the battery pack for power source, you can adjust the brightness by selecting [LCD B.L.] in the  (LCD SET) menu (p. 51).
- The recorded picture will not be affected by this setting.
- You can turn off the operation confirmation beep by setting [BEEP] in the  (OTHERS) menu to [OFF] (p. 57).

### Adjusting the viewfinder

You can view images using the viewfinder when you close the LCD panel. Use the viewfinder when the battery is running out, or when the screen is hard to see.

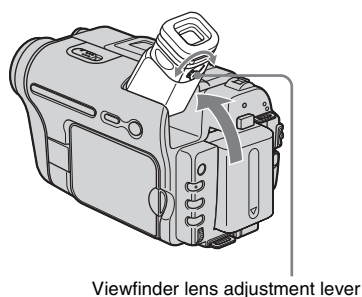

- 1 Lift up the viewfinder.
- 2 Adjust the viewfinder lens adjustment lever until the picture is clear.



## Step 5: Setting the date and time

Set the date and time when using this camcorder for the first time. If you do not set the date and time, the [CLOCK SET] screen appears every time you turn on your camcorder.

### Note

- If you do not use your camcorder for about **3 months**, the built-in rechargeable battery gets discharged and the date and time settings may be cleared from the memory. In that case, charge the rechargeable battery (p. 100) and then set the date and time again.

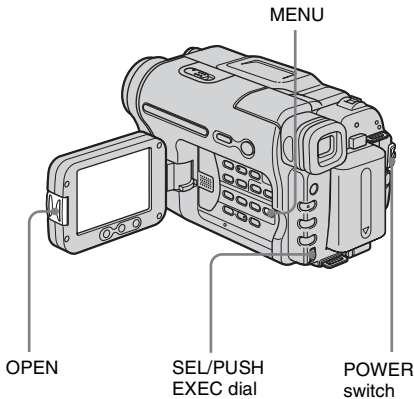

### 1 Turn on your camcorder (p. 15).

### 2 Press OPEN and open the LCD panel.

Proceed to step 6 when you set the clock for the first time.

### 3 Press MENU.

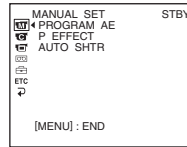

### 4 Turn the SEL/PUSH EXEC dial to select [SETUP MENU], then press the dial.

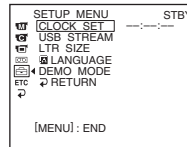

### 5 Turn the SEL/PUSH EXEC dial to select [CLOCK SET], then press the dial.

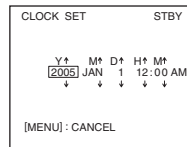

### 6 Turn the SEL/PUSH EXEC dial to set [Y] (year), then press the dial.

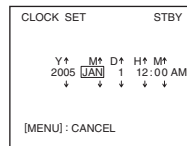

You can set any year up to the year 2079.

### 7 Set [M] (month), [D] (day), [H] (hour) and [M] (minute) in the same way as was done in step 6, then press the dial.

For midnight, set it to 12:00 AM.  
For midday, set it to 12:00 PM.

→ continued

## To check the preset date and time

For **Hi8** TRV138/338:

Press DATE to display the date indicator.

Press TIME to display the time indicator.

Press DATE (or TIME) and then press TIME (or DATE) to simultaneously display the date and time indicator.

To hide the date and/or time indicator, press DATE and/or TIME again.

## Step 6: Inserting a cassette tape

You can use standard 8 mm **8** and Hi8 **Hi8**, Digital8 **D8** video cassettes on your camcorder. For details on these cassettes (such as write-protection), see page 95.

### Notes

- Do not force the cassette into the compartment. This may cause a malfunction of your camcorder.
- For **D8**TRV280:  
The recording time when you use your camcorder is half of the indicated time on Hi8 **Hi8** tape. If you select the [LP] mode in the menu settings, the recording time is 3/4 of the indicated time on Hi8 **Hi8** tape.

- 1** Slide the **OPEN/EJECT** lever in the direction of the arrow and open the lid until it clicks.

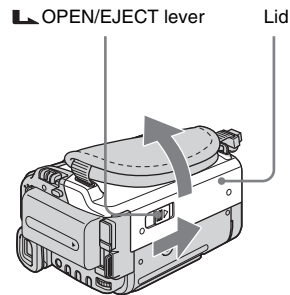

The cassette compartment automatically comes out and opens up.

- 2 Insert a cassette with its window-side facing up.

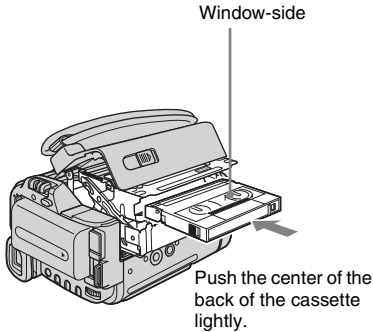

- 3 Press **PUSH**.  
The cassette compartment automatically slides back in.

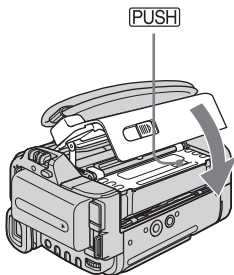

- 4 Close the lid.

### To eject the cassette

- 1 Slide the **OPEN/EJECT** lever in the direction of the arrow and open the lid.  
The cassette compartment automatically comes out.
- 2 Take out the cassette, then press **PUSH**.  
The cassette compartment automatically slides back in.
- 3 Close the lid.

## Step 7: Setting the screen language

You can select the language to be used on the LCD screen.

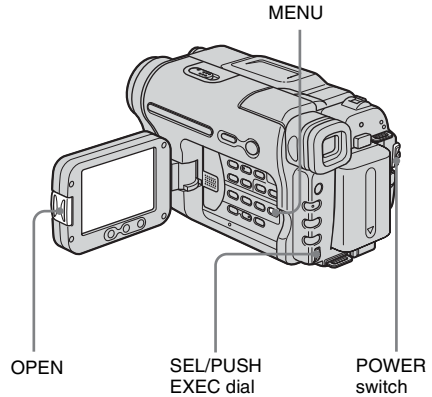

- 1 Turn on your camcorder.
- 2 Press **OPEN** to open the LCD panel.
- 3 Press **MENU**.

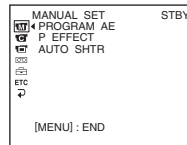

- 4 Turn the **SEL/PUSH EXEC** dial to select **SETUP MENU**, then press the dial.

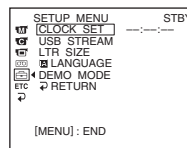

→ continued

---

**5** Turn the SEL/PUSH EXEC dial to select [  LANGUAGE], then press the dial.

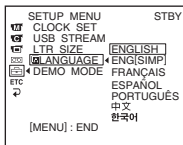

---

**6** Turn the SEL/PUSH EXEC dial to select the desired language, then press the dial.

---

**7** Press MENU.

---

 **Tip**

- Your camcorder offers [ENG [SIMP]] (simplified English) for when you cannot find your native tongue among the options.

# Recording movies

Before recording, follow steps 1 to 7 in “Getting started” (p. 11 - p. 19).

For **Hi8** TRV138/338:

Movies will be recorded along with monaural sound.

For **D** TRV280:

Movies will be recorded along with stereo sound.

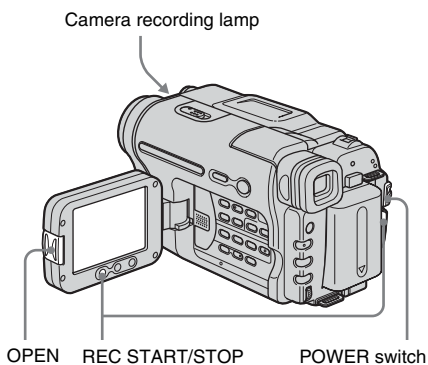

## Note

- For **Hi8** TRV138/338:  
The date is automatically recorded for 10 seconds after you start recording (Auto date function). This function works only once a day. See page 55 for details.

## Tip

- Performing Easy Handycam operation, even first time users can record easily. For details, see page 26.

## 1 Remove the lens cap. Pull the lens cap string down and attach it to the grip belt.

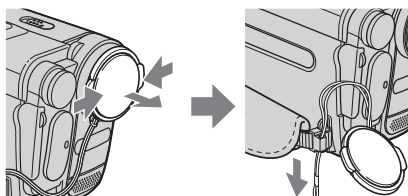

## 2 Press OPEN and open the LCD panel.

## 3 Slide the POWER switch until the CAMERA lamp lights up.

Your camcorder is set to the standby mode.

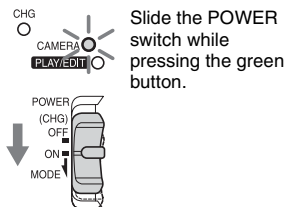

## 4 Press REC START/STOP.

Recording starts. [REC] appears on the LCD screen and the Camera recording lamp lights up.  
Press REC START/STOP again to stop recording.

## To turn the power off

Slide the POWER switch up to (CHG) OFF.

## Tip

- If you do not use your camcorder for a long time, remove the cassette and store it.

→ continued

## Indicators displayed during recording

The indicators will not be recorded on the tape.

For **Hi8** TRV138/338:

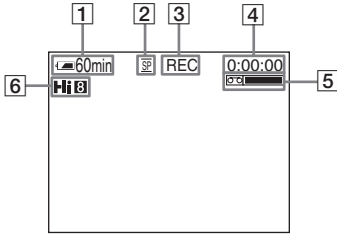

For **TRV280**:

Date/time and camera settings data (p. 37) will not be displayed during recording.

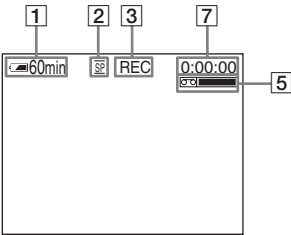

### 1 Remaining battery time

The indicated time may not be correct depending on the environment of use. When you opened or closed the LCD panel, it takes about 1 minute to display the correct remaining battery time.

### 2 Recording mode (SP or LP)

### 3 Recording status ([STBY] (standby) or [REC] (recording))

### 4 Tape counter (hour: minute: second) (Hi8 TRV138/338)

To set the counter to 0:00:00, press COUNTER RESET (p. 106).

### 5 Recording capacity

For **Hi8** TRV138/338:

This appears after you insert a cassette and record for a while.

For **TRV280**:

This appears after a while when you set the POWER switch to CAMERA and insert a cassette.

### 6 Hi8 format (Hi8 TRV138/338)

This appears while recording Hi8 format tapes.

### 7 Time code/Tape counter (hour: minute: second)/Tape photo recording (TRV280)

## Notes

- Before changing the battery pack, slide the POWER switch up to (CHG) OFF.
- In the default setting, if you do not operate the camcorder for more than about 5 minutes, the power will automatically turn off to preserve battery power ([A.SHUT OFF], p. 57). To restart recording, slide the POWER switch down to select CAMERA, and then press REC START/STOP.



## Tips

- You can also use REC START/STOP on LCD frame to record moving pictures. It is useful when you record from a low-angle or record by yourself in the mirror mode.
- To press REC START/STOP on LCD frame, support the LCD panel with your hand.
- To ensure smooth transition on a tape from the last recorded scene to the next, note the following.
  - Do not remove the cassette. (The picture will be recorded continuously without a break even when you turn the power off.)
  - Do not record pictures in SP mode and LP mode on the same tape.
  - Avoid stopping then recording a movie in the LP mode.
- For **TRV280**:  
The recording time, date, and the camera settings data are recorded automatically on the tape without being displayed on the screen. You can view this information during playback by selecting [DATA CODE] on the screen (p. 57).

## Recording for a longer time

### To record for a longer time

In the  (TAPE SET) menu, select [REC MODE], then [LP] (p. 52).

In the LP mode, you can record longer than when recording in the SP mode (2 times longer for  TRV138/338, 1.5 times longer for  TRV280).

A tape recorded in the LP mode should be played back only on this camcorder.

## Using zoom

When the CAMERA mode is selected, you can choose zoom to magnification levels greater than 20 times, and from that point activate the digital zoom ([D ZOOM], p. 45). Occasional use of the zoom is effective, but use it sparingly for best results.

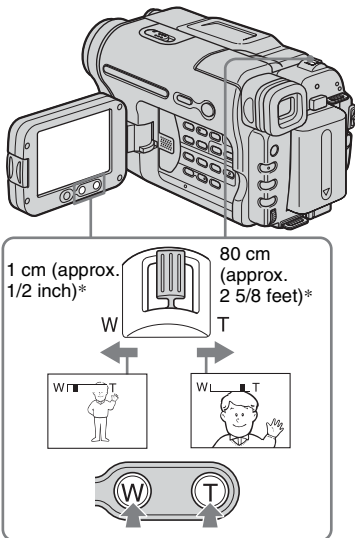

\* The minimum distance required between your camcorder and the subject to get a sharp focus in that position of the lever.

Move the power zoom lever slightly for a slower zoom. Move it further for a faster zoom.

### To record wider range of view

Move the power zoom lever towards W. The subject appears farther away (Wide angle).

### To record closer view

Move the power zoom lever towards T. The subject appears closer (Telephoto).

## To use the zoom buttons on LCD frame

Keep W pressed to record wider range of view, and keep T pressed to record closer view.

### Notes

- You cannot change the zoom speed with the zoom buttons on LCD frame.
- To press the zoom buttons on LCD frame, support the LCD panel with your hand.

## Using the built-in light

You can use the built-in light to suit your shooting situation. The recommended distance between the subject and camcorder is about 1.5 m (5 feet).

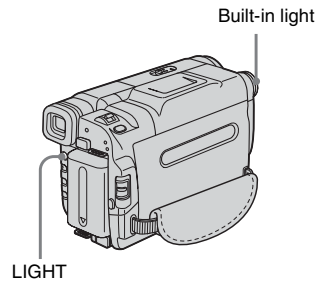

## Press LIGHT repeatedly to select a setting.

The settings are displayed cyclically in the following order.

No indicator displayed: Always records without using the built-in light.



→ continued

 **AUTO** : Automatically turns on and off according to the ambient brightness.







 **ON** : Always turns on.

## To turn off the built-in light

Press **LIGHT** repeatedly until no indicator appears on the screen.

### Notes

- The built-in video light emits very bright light, which is perfectly safe in normal use. However, avoid directly aiming the light at a subject's eyes from very close range.
- The battery pack discharges quickly while the built-in light is turned on.
- When you do not use your camcorder, turn the built-in light off and remove the battery pack to avoid turning on the built-in light accidentally.
- When flickering occurs while shooting in the  **AUTO** mode, press **LIGHT** until  **ON** appears.
- The built-in light may turn on/off when you use the [PROGRAM AE] or back light function while shooting in the  **AUTO** mode.
- For  **TRV280**:  
The built-in light is turned off during the interval time of Interval recording.
- When you use the conversion lens (optional), light from the built-in light is blocked and may not illuminate the subject properly.

## Recording in mirror mode

You can turn the LCD panel towards the subject so that you and your subject can share the image being recorded. You can also utilize this function when recording yourself, or to keep the attention of small children attracted to the camcorder while you record them.

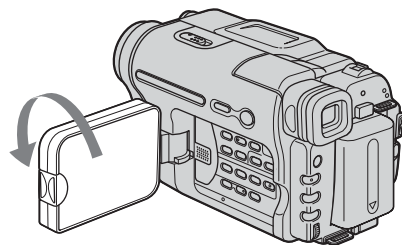





**Open the LCD panel 90 degrees to the camcorder, then rotate it 180 degrees towards the subject.**

A mirror-image of the subject appears on the LCD screen, but the picture will be normal when recorded.

### Notes

For  **TRV138/338**:

-  appears in the viewfinder and on the LCD screen.   appears in the standby mode, and  appears in the recording mode. Some of other indicators appear mirror-reversed and others are not displayed.
- During recording in the mirror mode, **DATE** and **TIME** on your camcorder do not work.



## Superimposing the date and time on pictures (Hi TRV138/338)

You can record the date and/or time displayed on the screen superimposed on the picture.

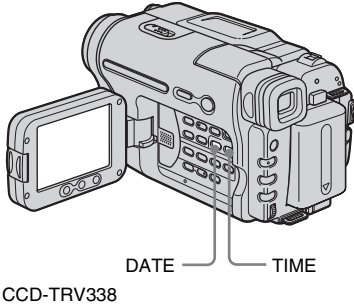

- Press **DATE** to record the date.
- Press **TIME** to record the time.
- Press **DATE (or TIME)**, then press **TIME (or DATE)** to record the date and time.

To hide the date and time, press **DATE** and/or **TIME** again.

When you purchase your camcorder, the clock is not set up yet. Set the date and time to your local time before using (p. 17).

### Note

- The date and time indicators recorded manually cannot be deleted.

### Tip

- If you do not record the date and time in the picture, record the date and time in the black screen as the background for about 10 seconds, then erase the date and time indicators before starting actual recording.

## Recording still images

### – Tape photo recording (E TRV280)

You can record still images. Before recording, follow steps 1 to 7 in “Getting started” (p. 11 - p. 19).

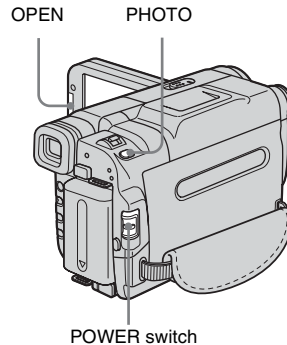

- 1 Remove the lens cap. Pull the lens cap string down and attach it to the grip belt.

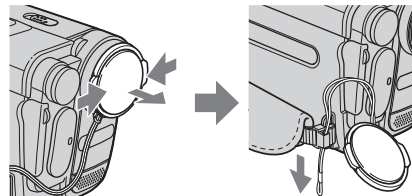

- 2 Press **OPEN** and open the LCD panel.

→ continued

---

### 3 Slide the POWER switch to select the CAMERA mode.

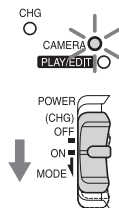

Slide the POWER switch while pressing the green button.

---

### 4 Press and hold PHOTO lightly.

You will hear a small beep sound, and the picture will become a still image. Recording does not start at this point.

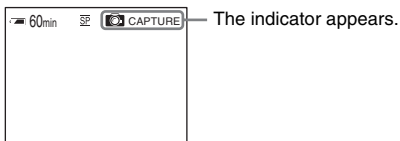

---

### 5 Press PHOTO fully.

A shutter sound is heard, and the image is recorded with sound for 7 seconds.

The still image is displayed on the screen until recording is completed.

---

## To turn the power off

Slide the POWER switch up to (CHG) OFF.

#### Note

-  appears when the tape photo recording does not work.

#### Tip

- You can record about 510 images in the SP mode and about 765 images in the LP mode on a tape which can record for 60 minutes in the SP mode.

---

# Recording with ease

## – Easy Handycam

With this Easy Handycam operation, most of the camera settings are set to automatic mode, only basic functions become available, and screen font size increases for easy viewing. Even first time users can enjoy easy recording. Before recording, follow steps 1 to 7 in “Getting started” (p. 11 - p. 19).

Camera recording lamp    EASY    POWER switch

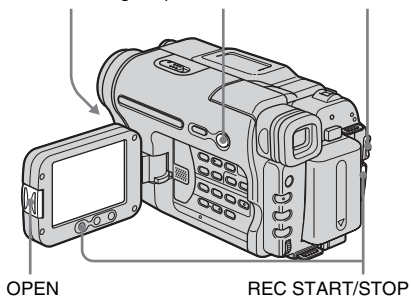

#### Tip

- Buttons that do not work during Easy Handycam operation have a dot beside them on your camcorder. Also, only menu items that are available during Easy Handycam operation are displayed when MENU is pressed.

---

### 1 Remove the lens cap. Pull the lens cap string down and attach it to the grip belt.

---

### 2 Press OPEN and open the LCD panel.

---

### 3 Slide the POWER switch to select the CAMERA mode.

You can record movies only.

---

### 4 Press EASY.

EASY lights up in blue.

Easy Handycam  
operation  
ON

## 5 Press REC START/STOP.

Recording starts. [REC] appears on the LCD screen and the Camera recording lamp lights up. Press REC START/STOP again to stop recording.

## To turn the power off

Slide the POWER switch up to (CHG) OFF.

## To cancel Easy Handycam operation

Press EASY again.

### ⚡ Notes

- You cannot switch from/to Easy Handycam operation during recording.
- For **TRV280**:  
During Easy Handycam operation, you cannot connect the USB cable to your camcorder.
- For **TRV280**:  
You cannot use Easy Handycam operation together with USB Streaming.
- All the settings return to their defaults during Easy Handycam operation. Previously made settings are restored when you cancel Easy Handycam operation.

# Adjusting the exposure

The exposure is adjusted automatically in the default setting.

## Adjusting the exposure for backlit subjects

When your subject has its back to the sun or other light, you can adjust the exposure to prevent the subject from becoming shadowed.

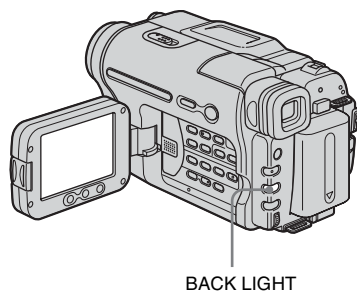

## Press BACK LIGHT in CAMERA mode.

 appears.

To cancel the back light function, press BACK LIGHT again.

### ⚡ Note

- The back light function is canceled when you press EXPOSURE (p. 28).

## Adjusting the exposure manually

You can fix the brightness of a picture at the best exposure. When recording indoors on a clear day, for instance, you can avoid backlight shadows on people next to the window by manually fixing the exposure to that of the wall side of the room.

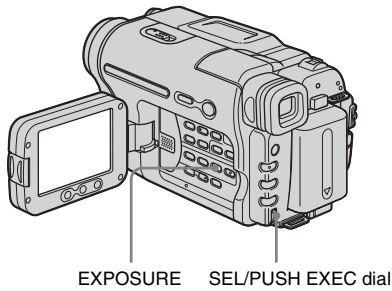

### 1 Press EXPOSURE in CAMERA mode.

The exposure indicator appears on the screen.

### 2 Turn the SEL/PUSH EXEC dial to adjust the brightness.

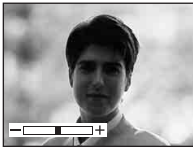

While exposure is set to manual mode,  $\infty$  is displayed in the left-hand corner of the screen.

## To return the setting to automatic exposure

Press EXPOSURE.

## Recording in dark places

### – NightShot plus

You can record subjects in dark places (such as when capturing the face of your baby sleeping) with this function.

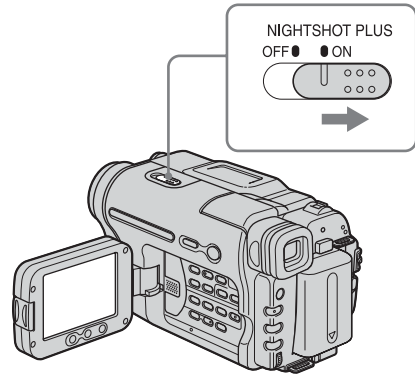

### Set the NIGHTSHOT PLUS switch to ON.

$\square$  and [“NIGHTSHOT PLUS”] appear.

To cancel NightShot plus, set the NIGHTSHOT PLUS switch to OFF.

### ⚡ Notes

- Do not use the NightShot plus function in bright places. This may cause a malfunction.
- You cannot use the NightShot plus function together with:
  - [PROGRAM AE]
  - Manual exposure
- Adjust the focus manually when it is hard to focus automatically.
- Do not cover the infrared port with your fingers or other objects. Remove the conversion lens (optional) if it is attached.
- Depending on the shooting conditions or circumstances, colors may not be reproduced properly.

### 💡 Tip

- If you record subjects in complete darkness, set [N.S. LIGHT] to [ON] in the menu settings. The maximum shooting distance using the NightShot Light is about 3 meters (10 feet). If you record subjects in dark places (such as night scene or in moonlight), set [N.S. LIGHT] to [OFF] in the menu settings. You can make image color deeper (p. 48).

## Adjusting the focus manually

The focus is adjusted automatically in the default setting.

You can adjust the focus manually according to the recording conditions.

Use this function in the following cases.

- To record a subject behind a window covered with raindrops.
- To record horizontal stripes.
- To record a subject with little contrast between the subject and its background.
- When you want to focus on a subject in the background.



- To record a stationary subject using a tripod.

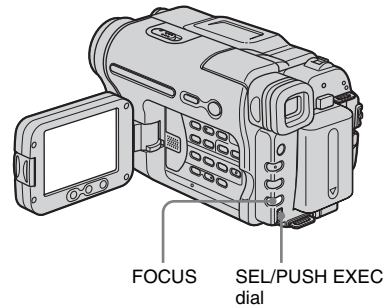

### 1 Press FOCUS in CAMERA mode.

☞ appears.

### 2 Turn the SEL/PUSH EXEC dial to sharpen focus.

☞ changes to ▲ when the focus cannot be adjusted any further. ☞ changes to 👤 when the focus cannot be adjusted any closer.

→ continued

### Tips for focusing manually

- It is easier to focus on the subject when you use the zoom function. Move the power zoom lever towards T (telephoto) to adjust the focus, and then, towards W (wide angle) to adjust the zoom for recording.
- When you want to record a close-up image of a subject, move the power zoom lever towards W (wide angle) to fully magnify the image, then adjust the focus.

### To adjust the focus automatically

Press FOCUS again.

## Recording a picture using various effects

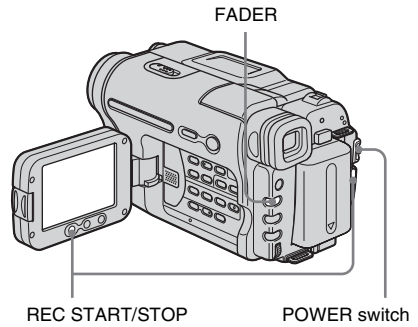

### Fading in and out of a scene – FADER

You can add the following effects to currently recording pictures.



#### [BLACK FADER]



#### [WHITE FADER]



#### [MOSAIC FADER]



## [STRIPE FADER]

This feature is for **Hi8** TRV138/338 only.



## [MONOTONE FADER]

When fading in, the picture gradually changes from black-and-white to color.

When fading out, the picture gradually changes from color to black-and-white.

**1** Slide the **POWER** switch to select the **CAMERA** mode.

**2** Press **FADER** until the desired fader indicator flashes in the standby mode (to fade in) or during recording (to fade out).



**3** Press **REC START/STOP**.

The fader indicator stops flashing and disappears when the fade is complete.

## To cancel the operation

In step 2, press **FADER** repeatedly until the indicator disappears.

### ⚡ Notes

- For **TRV280**:
  - Tape photo recording
  - [FRAME REC] (Frame recording)
  - [INT. REC] (Interval recording)
- Titles do not fade in or fade out. The date and time indicator for **Hi8** TRV138/338 also does not fade in or fade out. Erase them before operating the **FADER** function if they are not needed.

# Superimposing a title

You can insert a title when recording.

You can select one of the 8 preset titles and the 2 custom titles.

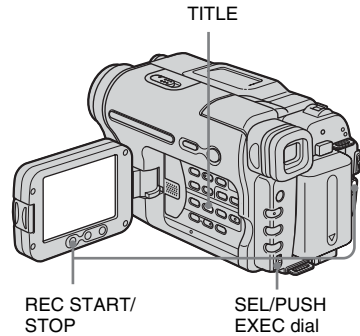

**1** Slide the **POWER** switch to select the **CAMERA** mode, then press **TITLE**.

Select a desired title from the displayed titles (2 original titles that you have created before and the preset titles that have been stored in your camcorder). You can create original titles (up to 2 types of title of within 20 characters each) in the following procedure.

**1** Turn the **SEL/PUSH EXEC** dial to select [CUSTOM1\*\*\*\*] or [CUSTOM2\*\*\*\*], then press the dial.

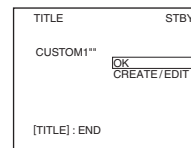

**2** Turn the **SEL/PUSH EXEC** dial to select [CREATE/EDIT], then press the dial.

**3** Turn the **SEL/PUSH EXEC** dial to select the column of the desired character, then press the dial.

→ continued

- 4 Turn the SEL/PUSH EXEC dial to select the desired character, then press the dial.

TITLE SET	P1	STBY
S		
ABCDE 12345	S#V01E	
FGHIJ 67890	zlo"	
KLMNO AEIOU	[←]	
PNRS# AEIOU	[→P2]	
UVWXY AEOE#	[OK]	
Z& ? ! AON#B		
"/ - AIOUA		
[TITLE]: END		

To erase a character: Select [←].

To enter a space: Select [Z& ? !], then select the blank part between & and ?.

To select alphabet and Russian characters: Select [→P2].

- 5 Turn the SEL/PUSH EXEC dial to select the next character, and enter the character in the same manner.
- 6 When you have finished entering characters, turn the SEL/PUSH EXEC dial to select [OK], then press the dial. The title is stored in memory.

## 2 Turn the SEL/PUSH EXEC dial to select the title you want to insert, then press the dial.

To insert an original title, turn the SEL/PUSH EXEC dial to select [CUSTOM1"""] or [CUSTOM2"""], and press the dial, then select [OK] and press the dial.

## 3 Change [COLOR], [SIZE], or [POSITION] as necessary.

- 1 Turn the SEL/PUSH EXEC dial to select [COLOR], [SIZE], or [POSITION], then press the dial. The selected item appears on the screen.
- 2 Turn the SEL/PUSH EXEC dial to select the desired item, then press the dial.
- 3 Repeat steps 1 and 2 until the title is laid out as desired.

### [COLOR] (color)

[WHITE] ↔ [YELLOW] ↔  
[VIOLET] ↔ [RED] ↔ [CYAN] ↔  
[GREEN] ↔ [BLUE]

### [SIZE] (size)

[SMALL] ↔ [LARGE]  
(You can only select [SMALL] when you are entering more than 13 characters.)

### [POSITION] (position)

You can select from 8 to 9 choices.

## 4 Turn the SEL/PUSH EXEC dial to select [OK], then press the dial.

The title appears.

## 5 Press REC START/STOP.

## 6 Press TITLE at the scene you want to erase the title off.

## To superimpose the title while you are recording

Press TITLE and carry out steps 2 to 4. When you press the SEL/PUSH EXEC dial at step 4, the title is recorded.

### Notes

- If you display the menu while superimposing a title, the title is not recorded while the menu is displayed.
- When you are selecting and setting the title, the title displayed on the screen is not recorded.
- When you superimpose a title while you are recording, the beep does not sound.
- When you are using your camcorder on the battery pack and do not operate it for 5 minutes, the power automatically goes off as the default setting. If you may take 5 minutes or longer to enter characters, set [A.SHUT OFF] in the [ETC] (OTHERS) menu to [NEVER] (p. 57). The power will not be turned off. Even though the power goes off, the characters you have entered remain stored in memory. Turn the power back on, then start again from step 1 to continue superimposing the title.
- For **Hi8** TRV138/338:  
The date and time, or either of them, may not be displayed depending on the size or position of the title.

### Tip

- To change a created title, select the title in step 1. Turn the SEL/PUSH EXEC dial to select [CREATE/EDIT] and press the dial, then reselect characters.



# Searching for the last scene of the most recent recording

## – END SEARCH

This function is handy when you have played back the tape, for example, but want to start recording right after the most recently recorded scene. The END SEARCH function will not work once you eject the cassette after you have recorded on the tape.

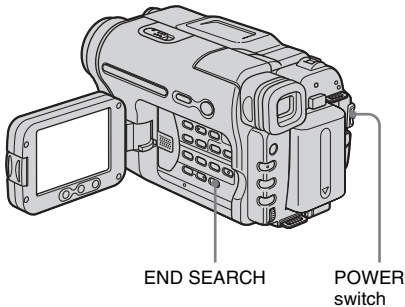

---

**1** Slide the **POWER** switch to select the **CAMERA** mode.

---

**2** Press **END SEARCH**.

The last scene of the most recent recording is played back for about 5 seconds, and the camcorder enters the standby mode at the point where the last recording has finished.

---

### To cancel the operation

Press **END SEARCH** again.

#### **Note**

- The **END SEARCH** function will not work correctly when there is a blank section between recorded sections on the tape.

#### **Tip**

- When **PLAY/EDIT** mode is selected, you can do this operation by pressing **END SEARCH**.

# Viewing pictures recorded on a tape

Make sure you have a recorded cassette inserted into your camcorder.  
When you want to play back the recorded picture on your TV, see page 39.

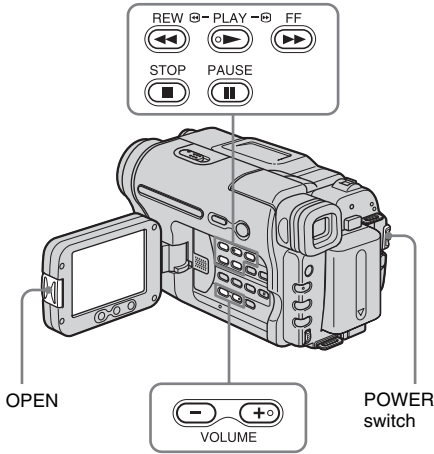

**Tip**

- Performing Easy Handycam operation, even first time users can play back easily. For details, see page 36.

## 1 Press OPEN and open the LCD panel.

## 2 Slide the POWER switch repeatedly to select the PLAY/EDIT mode.

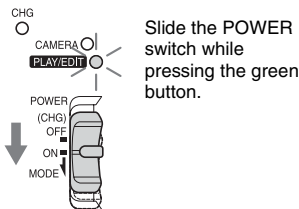

## 3 Press (rewind) to go to the point you want to view.

## 4 Press (play) to start playback.

### To adjust the volume

Press either of the two buttons on VOLUME. When you close the LCD panel, sound is turned off.

- : To turn the volume down
- : To turn the volume up

### To stop playback

Press (stop).

### To pause

Press (pause) during playback. Press (pause) or (play) to restart the playback.

Playback stops automatically when pause mode continues for a few minutes.

### To fast forward or rewind

Press (fast forward) or (rewind) in stop mode.

### To review movies on the viewfinder

Close the LCD panel.

### Indicators displayed during playing back

For Hi8 TRV138/338:

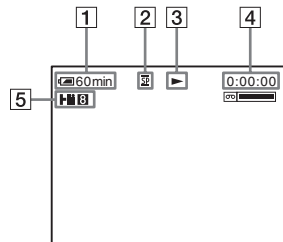

For **TRV280**:

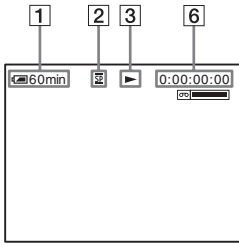

- 1 Remaining battery time**
- 2 Recording mode (SP or LP)**
- 3 Tape transport indicator**
- 4 Tape counter (hour: minute: second)  
(**TRV138/338**)**
- 5 Hi8 format (**TRV138/338**)**  
This appears while playing back Hi8 format tapes.
- 6 Time code (hour: minute: second: frame)  
or tape counter (hour: minute: second)  
(**TRV280**)**

**Note**

- For **TRV280**:  
If you use a standard 8 mm **8** tape, be sure to play back the tape on your camcorder. Mosaic noise may appear when you play back the standard 8 mm **8** tape on other camcorders (including another DCR-TRV280).

## Playing back in various modes

### To fast forward or rewind during playback – Picture search

Keep on pressing **FF** (fast forward) or **REW** (rewind) during playback.

To resume normal playback, release the button.

### To view the picture while fast forwarding or rewinding – Skip scan

Keep on pressing **FF** (fast forward) or **REW** (rewind) while fast forwarding or rewinding the tape.

To resume fast forwarding or rewinding, release the button.

**Note**

- For **TRV138/338**:  
When you play back a tape recorded in the LP mode, noise may appear on the LCD screen in the following cases:
  - Playback pause
  - Picture search

# Playing back with ease

## – Easy Handycam

Easy Handycam operation allows easy playback for even first time users by providing only the basic functions for playback. Also screen font size increases for easy viewing. Make sure you have a recorded cassette inserted into your camcorder.

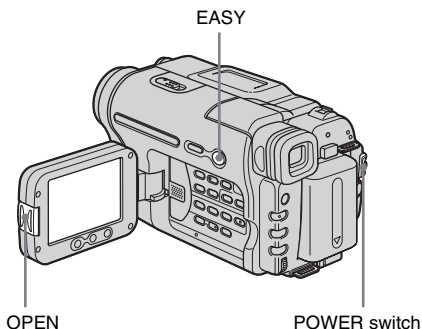

### 💡 Tip

- Buttons that do not work during Easy Handycam operation have a dot beside them on your camcorder. Also, only menu items that are available during Easy Handycam operation are displayed when MENU is pressed.

## 1 Press OPEN and open the LCD panel.

## 2 Slide the POWER switch repeatedly to select the PLAY/EDIT mode.

## 3 Press EASY.

EASY lights up in blue.



## 4 Play back a tape.

The following buttons can be operated.

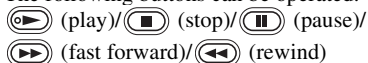

## To cancel Easy Handycam operation

Press EASY again.

### ⚠ Notes

For **TRV280**:

- During Easy Handycam operation, you cannot connect the USB cable to your camcorder.
- You cannot use Easy Handycam operation together with USB Streaming.

# Various playback functions

You can display the recorded date on the screen.

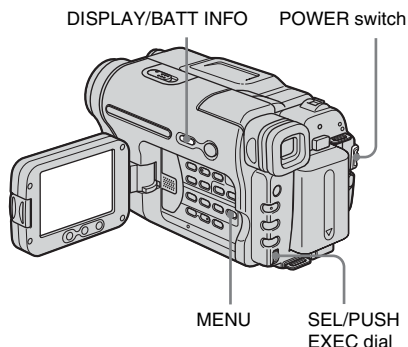

## Displaying the screen indicators

You can choose to display the time code, tape counter, and other information on the screen.

### Press DISPLAY/BATT INFO.

The indicators appear/disappear as you press the button.

#### Tip

- You can display the screen indicators during playback on a TV. Select the [ETC] (OTHERS) menu, [DISPLAY], then [V-OUT/LCD] (p. 58).

## Displaying the date/time and camera settings data – Data code (B TRV280)

During playback, you can view the date/time data ([DATE/TIME]) and the camera settings data ([CAM DATA]) that are automatically recorded while recording pictures on a tape.

- Slide the **POWER** switch repeatedly to select the **PLAY/EDIT** mode.
- Press **MENU** during playback or playback pause.
- Turn the **SEL/PUSH EXEC** dial to select [ETC] (OTHERS), then press the dial.
- Turn the **SEL/PUSH EXEC** dial to select [DATA CODE], then press the dial.

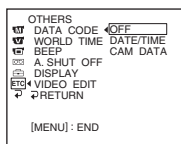

- Turn the **SEL/PUSH EXEC** dial to select the [DATE/TIME] or [CAM DATA], then press the dial.

- Press **MENU**.

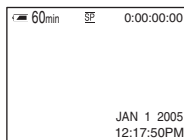

## To hide the date/time or the camera settings data

Follow steps 2 to 4, and select [OFF] in step 5.

### Camera settings data display

In the date/time data display, the date and time is displayed in the same area.

If you record the picture without setting the clock, [--- -- ----] and [--:--:--] will appear.

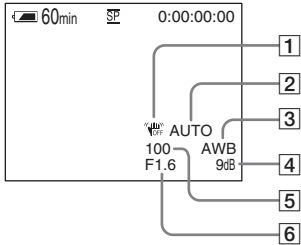

- 1 SteadyShot off
- 2 Exposure
- 3 White balance
- 4 Gain
- 5 Shutter speed
- 6 Aperture value

# Playing the picture on a TV

Connect your camcorder to a TV using the supplied A/V connecting cable as shown in the following illustration. Connect the supplied AC Adaptor to the wall outlet for the power supply (p. 12). Refer also to the instruction manuals supplied with the devices to be connected. To copy to another tape, see page 61.

## For Hi8 TRV138/338:

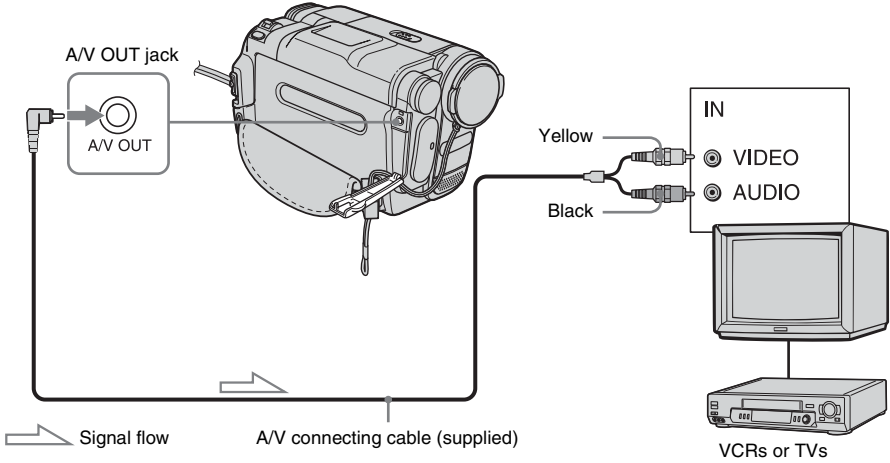

## For TRV280:

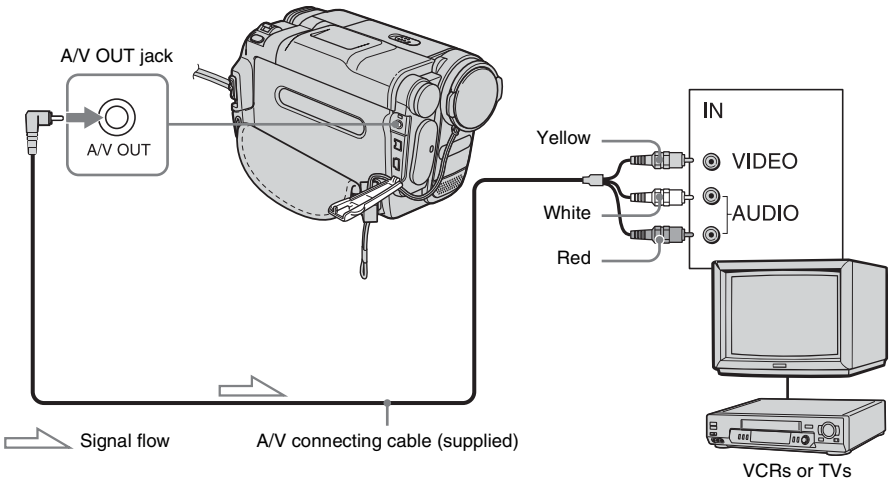

Playback

→ continued

### **When your TV is connected to a VCR**

Connect your camcorder to the LINE IN input on the VCR using the A/V connecting cable. Set the input selector on the VCR to LINE.

### **When your TV is stereo**

For  TRV138/338:

Connect the audio plug of the A/V connecting cable to the left (white) input jack of your TV.

### **When your TV is monaural (When your TV has only one audio input jack)**

For  TRV280:

Connect the yellow plug of the A/V connecting cable to the video input jack and connect the white or the red plug to the audio input jack of your TV or VCR.

When you want to play the sound in monaural mode, use a connecting cable (optional) for that purpose.



**Customizing Your Camcorder**

# Changing the menu settings

You can change various settings or make detailed adjustments using the menu items displayed on the screen.

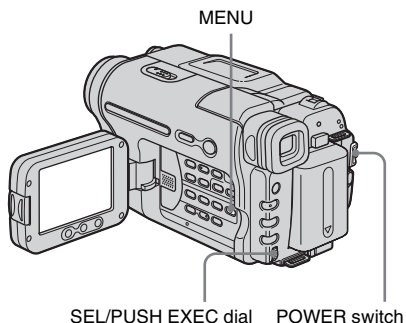

**1 Turn on the power (p. 15).**

**2 Press MENU.**

The menu screen appears.

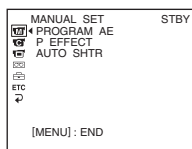

**3 Turn the SEL/PUSH EXEC dial to select the desired menu, then press the dial.**

- MANUAL SET (p. 42)
- CAMERA SET (p. 45)
- PLAYER SET (p. 49) (Hi8 TRV138/338)
- VCR SET (p. 49) (TRV280)
- LCD SET (p. 51)
- TAPE SET (p. 52)
- SETUP MENU (p. 55)

**4 Turn the SEL/PUSH EXEC dial to select the desired item, then press the dial.**

The available menu items vary depending on the position of the POWER switch. Unavailable items will be grayed out.

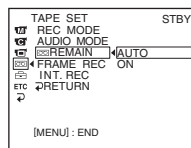

**5 Turn the SEL/PUSH EXEC dial to select the desired mode, then press the dial.**

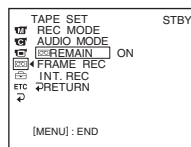

**6 Press MENU to hide the menu screen.**

If you want to change other items, select [RETURN] and press the dial, then repeat steps from 3 to 5.

# Using the (MANUAL SET) menu

## – PROGRAM AE/P EFFECT, etc.





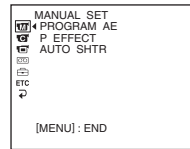







You can select items listed below in the MANUAL SET menu. To select these items, see “Changing the menu settings” (p. 41).

The default settings are marked with ▷. The settings you can adjust vary depending on the power mode of your camcorder. The screen shows the items you can operate at the moment. Unavailable items will be grayed out.



## PROGRAM AE

You can record pictures easily in a situation that requires various techniques by selecting the following settings.

▷ AUTO	Select this when not using PROGRAM AE.	
SPOTLIGHT* (spotlight) (  )	Select to prevent people’s faces from appearing excessively white when subjects are lit by strong light, such as in a theater or at a wedding.	
PORTRAIT (soft portrait) (  )	Select to bring out the subject such as people or flowers while creating a soft background.	
SPORTS* (sports lesson) (  )	Select to minimize shake when shooting fast-moving subjects such as in tennis or golf.	
BEACH&SKI* (beach & ski) (  )	Select to prevent people’s faces from appearing dark in strong light or reflected light, such as at a beach in midsummer or on a ski slope.	
SUNSETMOON** (sunset & moon) (  )	Select to maintain the atmosphere of situations such as sunsets, general night views, fireworks, and neon signs.	
LANDSCAPE** (landscape) (  )	Select when shooting distant subjects such as mountains. This setting also prevents your camcorder from focusing on glass or metal mesh in windows that comes in between the camcorder and the subject.	

\* Your camcorder is adjusted to focus only on subjects in the middle to far distance.

\*\*Your camcorder is adjusted to focus only on distant subjects.

**Note**

- When you set the NIGHTSHOT PLUS switch to ON, [PROGRAM AE] does not work.

## P EFFECT

For **Hi8** TRV138/338:







You can add special effects (such as films) to a picture before recording.

**[P+]** appears when each effect is selected.

For **D** TRV280:

You can add special effects (such as films) to a picture before or after recording.

**[P+]** appears when each effect is selected.

▷OFF	Select when not using the Picture effect setting.	
NEG.ART	Select to record/play the picture with the color and brightness of the picture reversed.	
SEPIA	Select to record/play the picture appearing in sepia.	
B&W	Select to record/play the picture appearing in monochrome (black-and-white).	
SOLARIZE	Select to record/play the picture looking like an illustration with strong contrast.	
SLIM	Select to record the picture appearing vertically expanded. (This effect is not available during playback.)	
STRETCH	Select to record the picture appearing horizontally expanded. (This effect is not available during playback.)	
PASTEL	Select to record the picture looking like a pale pastel drawing. (This effect is not available during playback.)	
MOSAIC	Select to record the picture appearing mosaic-patterned. (This effect is not available during playback.)	

**Note**

- For **D** TRV280:  
You cannot add effects to externally input pictures. Also, you cannot output pictures edited with Picture effects via the **i** DV Interface.

→ continued

 **Tip**

- For  TRV280:  
You can copy pictures edited using picture effects to another tape (p. 61).

## AUTO SHTR

▷ON	Select to automatically activate the electronic shutter to adjust the shutter speed when recording in bright conditions.
OFF	Select when recording without using the electronic shutter.

# Using the (CAMERA SET) menu

– 16:9 WIDE/STEADYSHOT, etc.

You can select items listed below in the CAMERA SET menu. To select these items, see “Changing the menu settings” (p. 41).

The default settings are marked with ▷. The settings you can adjust vary depending on the power mode of your camcorder. The screen shows the items you can operate at the moment. Unavailable items will be grayed out.

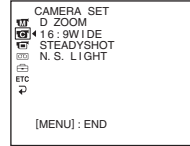

## D ZOOM

You can select the maximum zoom level in case you want to zoom to a level greater than 20 times while recording on a tape. Note that the image quality decreases when you are using the digital zoom. This function is useful when recording enlarged pictures of a distant subject, such as a bird.



The right side of the bar shows the digital zooming zone. The zooming zone appears when you select the zooming level.

▷OFF	Select to deactivate the digital zoom. Up to 20 times zoom is performed optically.
40 ×	Select to activate the digital zoom. 20 times through 40 times zoom is performed digitally.
990 ×	Select to activate the digital zoom. 20 times through 990 times zoom is performed digitally.

→ continued

## 16:9 WIDE

For **Hi8** TRV138/338:

You can record a cinema-like picture ([CINEMA] mode) or a 16:9 wide picture ([16:9 FULL] mode) to watch on the 16:9 wide-screen TV.

Refer also to the manuals supplied with your TV.

In [CINEMA] mode

When viewed on the LCD screen/viewfinder

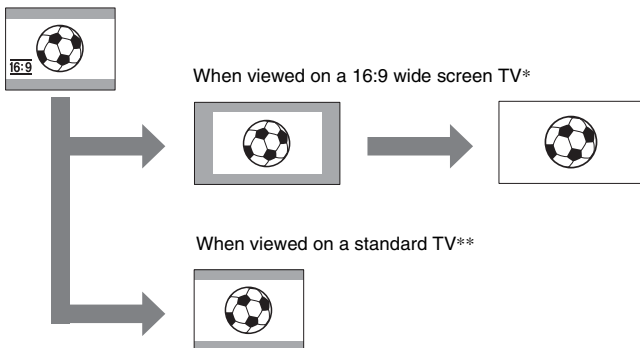

In [16:9 FULL] mode

When viewed on the LCD screen/viewfinder

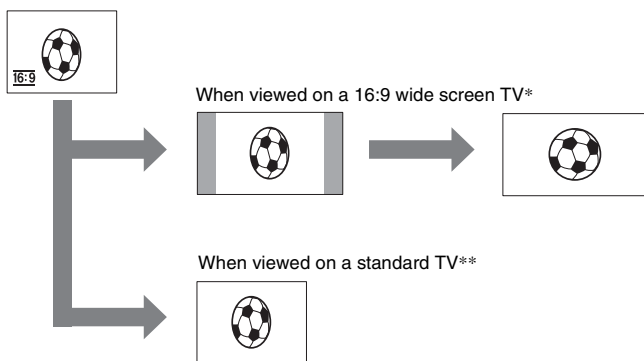

\* Picture appears in full screen when the wide-screen TV switches to full mode.

\*\*When you play a picture in 4:3 mode, it appears as you have seen on the LCD screen or in the viewfinder.

---

▷OFF Standard setting (to record pictures to play back on a 4:3 TV). The recorded picture will not be wide.

---

CINEMA (16:9) Select to record a picture to be played back in CINEMA mode.

---

16:9 FULL (16:9) Select to record a picture to be played back on a 16:9 wide TV.

---

**💡 Tips**

- The ID-1 system sends aspect ratio information (16:9, 4:3, or letter box) by inserting signals between video signals.
- When you record in the [16:9 FULL], the date or time indicator will be widened on wide-screen TVs.
- For **TRV338**:  
The SteadyShot does not work. If you set [16:9 FULL] in the menu settings when the SteadyShot is working,  flashes and the SteadyShot does not function.

For **TRV280**:

You can record a 16:9 wide picture on the tape to watch on a 16:9 wide-screen TV ([16:9 WIDE] mode).

When you connect your camcorder to a TV compatible with the ID-1/ID-2 system and play the tape, the TV switches to full mode automatically.

Refer also to the manuals supplied with your TV.

When viewed on the LCD screen

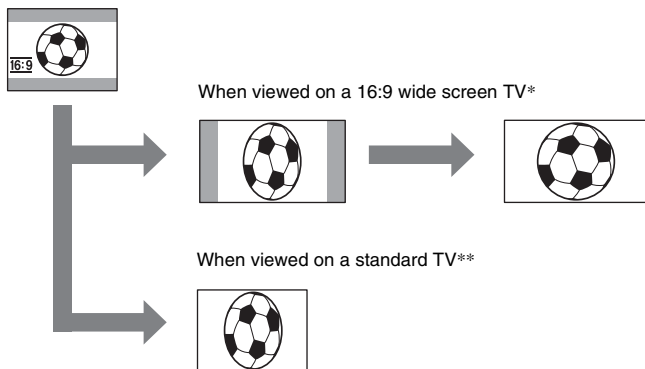

\* Picture appears in full screen when the wide-screen TV switches to full mode.

\*\*In 4:3 mode. When you play a picture in the wide mode, it appears as you have seen on the LCD screen.

▷OFF	Standard setting (to record pictures to play back on a 4:3 TV). The recorded picture will not be wide.
ON ( <u>16:9</u> )	Select to record a picture to be played back on a 16:9 wide TV. The recorded picture will be played in full mode when you connect to your TV compatible with ID-1/ID-2 systems.

**💡 Tips**

- The ID-1 system sends aspect ratio information (16:9, 4:3, or letter box) by inserting signals between video signals.
- The ID-2 system sends a copyright protection signal with the ID-1 signals inserted between video signals in an analog connection.
- The SteadyShot does not work. If you set [16:9 WIDE] to [ON] in the menu settings when the SteadyShot is working,  flashes and the SteadyShot does not function.



→ *continued*

## STEADYSHOT

For **Hi8** TRV338/**F**TRV280:

You can select this function to compensate for camera-shake.

---

▷ON	Standard setting (enable the SteadyShot function). If you select a function that STEADYSHOT cannot work with,  appears.
OFF (  )	Select to deactivate the SteadyShot function. Select to shoot a stationary subject with a tripod, or when using a conversion lens (optional). Natural pictures are produced.

---

### Note

- For **F**TRV280:  
Camera-shake cannot be completely compensated for in the following cases:
  - When recording in a dark place
  - When recording a subject with little contrast to the background
  - When recording horizontal stripes
  - When using the zoom
  - When recording a fast moving subject
  - When the zoom position is set to the W-end side

## N.S. LIGHT

When using the NightShot plus function to record, you can record clearer pictures by using the NightShot Light to emit infrared rays (invisible).

---

▷ON	Select to use the NightShot Light. (p. 28)
OFF	Select to disable the NightShot Light. (p. 28)

---



# Using the (PLAYER SET)/ (VCR SET) menu – HiFi SOUND/EDIT, etc.

The default settings are marked with ▷. The settings you can adjust vary depending on the power mode of your camcorder. The screen shows the items you can operate at the moment. Unavailable items will be grayed out.

You can select the items listed below in the menu (the PLAYER SET menu for **HiFi** TRV138/338, the VCR SET menu for **TRV280**). To select these items, see “Changing the menu settings” (p. 41).



## HiFi SOUND

For **TRV280**:  
You can select how to play back audio recorded on a tape in stereo mode.

▷STEREO	Select to play back a stereo tape or dual sound track tape with main and sub sound.
1	Select to play back a stereo tape with the left channel sound or a dual sound track tape with main sound.
2	Select to play back a stereo tape with the right channel sound or a dual sound track tape with sub sound.

**Notes**

- You can play back a dual sound track cassette on this camcorder. However, you cannot record a dual sound track on this camcorder.
- The setting returns to [STEREO] when you disconnect the power source from your camcorder for more than 5 minutes.

## EDIT

For **HiFi** TRV138/338:  
Picture degradation is minimized when you dub or edit a tape using the camcorder as the playback device.

▷OFF	Select this for no compensation.
ON	Select to minimize picture degradation.

**Note**

- The setting returns to [OFF] when you disconnect the power source from your camcorder for more than 5 minutes.

→ continued

## TBC

For  TRV138/338:

▷ON	Select to correct jitter (horizontal picture shake during playback).
OFF	Select to not compensate picture distortion when playing back a tape on which you have dubbed repeatedly or recorded TV game signals.

## DNR

For  TRV138/338:

▷ON	Select to eliminate color noise in the picture.
OFF	Select to minimize picture artifacts in a picture containing lots of movement.

## AUDIO MIX

For  TRV280:

You can adjust the audio balance between ST1 (the originally recorded sound) and ST2.

### Notes

- You cannot adjust sound recorded in 16 bit audio mode.
- Only the originally recorded sound will be heard when you disconnect the power source from your camcorder for more than 5 minutes.

# Using the (LCD SET) menu – LCD B.L./LCD COLOR, etc.

The default settings are marked with ▷. The settings you can adjust vary depending on the power mode of your camcorder. The screen shows the items you can operate at the moment. Unavailable items will be grayed out.

You can select the items listed below in the LCD SET menu. To select these items, see “Changing the menu settings” (p. 41).



## LCD BRIGHT

See page 16 for details.

## LCD B.L.

You can adjust the brightness of the LCD screen’s backlight. The recorded picture will not be affected by this setting.

▷BRT NORMAL	Standard brightness.
BRIGHT	Select to brighten the LCD screen.

### ⚙ Notes

- When you connect your camcorder to outside power sources, [BRIGHT] is automatically selected for the setting.
- When you select [BRIGHT], battery life is reduced by about 10 percent during recording.

## LCD COLOR

Turn the SEL/PUSH EXEC dial to adjust the color on the LCD screen. The recorded picture will not be affected by this setting.



# Using the (TAPE SET) menu – FRAME REC/INT.REC, etc.



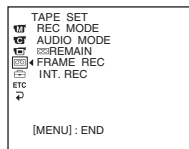

You can select items listed below in the TAPE SET menu. To select items, see “Changing the menu settings” (p. 41).

The default settings are marked with ▷. The settings you can adjust vary depending on the



power mode of your camcorder. The screen shows the items you can operate at the moment. Unavailable items will be grayed out.



## REC MODE

▷SP (  )	Select to record in the SP (Standard Play) mode on a cassette.
LP (  )	Select to increase the recording time from that of the SP mode (2 times longer for  TRV138/338, 1.5 times longer for  TRV280) (Long Play). The use of Sony cassettes is recommended to get the most out of your camcorder.

### 🔗 Notes

- If you record in the LP mode, a mosaic-like noise may appear or sound may be interrupted when you play back the tape on other camcorders or VCRs.
- For  TRV138/338:  
When you record a tape in the LP mode on your camcorder, recording is carried out in the standard 8 mm  system.
- For  TRV280:  
When you mix recordings in the SP mode and in the LP mode on one tape, the playback picture may be distorted or the time code may not be written properly between the scenes.

## AUDIO MODE

For  TRV280:

▷12BIT	Select to record in the 12-bit mode (2 stereo sounds).
16BIT (  )	Select to record in the 16-bit mode (1 stereo sound with high quality).

## ORC TO SET

For  TRV138/338:

You can automatically adjust the recording condition to get the best possible recording.

When you select [ORC TO SET] in the menu settings, [START/STOP KEY] appears. Press REC START/STOP. [ORC] appears on the screen and adjustment starts. Your camcorder returns to the standby mode when adjustment is complete. It takes about 10 seconds for adjustment.

### 🔗 Notes

- Each time you eject a cassette, this setting will be canceled.

- When you set [ORC TO SET], a non-recorded section of about 0.1 second appears on the tape. However, note that this non-recorded section disappears from the tape when you continue recording from this section.
- To check if you have already set this setting, select [ORC TO SET] in the menu settings. [ORC ON] is displayed if it is already set.

## REMAIN

▷AUTO	Select to display the remaining tape bar: <ul style="list-style-type: none"> <li>• For about 8 seconds after you turn on your camcorder with the cassette inserted, and your camcorder calculates the remaining amount of tape.</li> <li>• For about 8 seconds after  (play) is pressed.</li> <li>• For about 8 seconds after DISPLAY/BATT INFO is pressed to display the screen indicators.</li> <li>• For the period of tape rewinding, forwarding or picture search.</li> </ul>
ON	Select to always display the remaining tape indicator.

## FRAME REC

For  TRV280:

You can record pictures with a stop-motion animated effect by alternately frame recording and then moving the subject a little.

▷OFF	Select to record in the standard recording mode.
ON	Select to record pictures using the frame recording function. <ol style="list-style-type: none"> <li><b>1 Turn the SEL/PUSH EXEC dial to select [ON], then press the dial.</b></li> <li><b>2 Press MENU to hide the menu settings.</b>  lights up.</li> <li><b>3 Press REC START/STOP.</b> A picture (approximately 6 frames) is recorded, and your camcorder enters the standby mode.</li> <li><b>4 Move the subject and repeat step 3.</b></li> </ol>

### Notes

- When you use frame recording continuously, the remaining tape time will not be indicated correctly.
- The last scene will be longer than other scenes.

→ *continued*

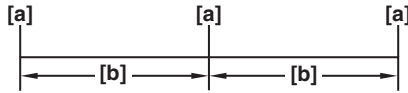

For **TRV280**:

You can achieve excellent recordings of flowers blooming, etc., with this function. Connect your camcorder to the wall outlet using the supplied AC Adaptor during the operation.



a. [REC TIME]

b. [INTERVAL]

- 1** Turn the SEL/PUSH EXEC dial to select [SET], then press the dial.
- 2** Turn the SEL/PUSH EXEC dial to select [INTERVAL], then press the dial.
- 3** Turn the SEL/PUSH EXEC dial to select the desired interval time (30 seconds, 1, 5, 10 minutes), then press the dial.
- 4** Turn the SEL/PUSH EXEC dial to select [REC TIME], then press the dial.
- 5** Turn the SEL/PUSH EXEC dial to select the desired recording time (0.5, 1, 1.5, 2 seconds), then press the dial.
- 6** Turn the SEL/PUSH EXEC dial to select [↶ RETURN], then press the dial.
- 7** Turn the SEL/PUSH EXEC dial to select [ON], then press the dial.
- 8** Press MENU to hide the menu settings.  
 flashes.
- 9** Press REC START/STOP.  
 The interval recording starts.  
 lights up during interval recording.  
 To cancel recording, set to [OFF] in the menu settings.

**Note**

- There may be a discrepancy in recording time of up to ± 6 frames from the selected time.

**Tips**

- If you adjust the focus manually, you may be able to record clear pictures even if the light changes (p. 29).
- You can silence the beeps during recording (p. 57).

# Using the (SETUP MENU) – CLOCK SET/USB STREAM/LANGUAGE, etc.

The default settings are marked with ▷. The settings you can adjust vary depending on the power mode of your camcorder. The screen shows the items you can operate at the moment. Unavailable items will be grayed out.

## LANGUAGE, etc.

You can select items listed below in the SETUP MENU. To select items, see “Changing the menu settings” (p. 41).

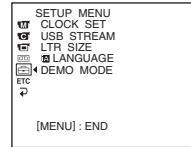

## CLOCK SET

You can set the date and time (p. 17).

## AUTO DATE

For **Hi8** TRV138/338:

You can automatically record the date once a day for 10 seconds after you start recording.

▷ON	Select to record the date for 10 seconds after recording has started.
OFF	Select to cancel the auto date function.

### Tip

- The auto date function automatically displays the date once a day. However, the date may automatically appear more than once a day if:
  - you set the date and time.
  - you eject and insert the tape again.
  - you stop recording within 10 seconds.
  - you set [AUTO DATE] to [OFF] once and set it back to [ON] in the menu settings.

## USB STREAM

For **D** TRV280:

You can connect a USB cable (supplied) to your camcorder, and view the picture displayed on the screen of your camcorder on your computer (USB Streaming). For details, refer to “First Step Guide” in the supplied CD-ROM.

▷OFF	Select to deactivate the USB Streaming function.
ON	Select to activate the USB Streaming function.

## LTR SIZE

▷NORMAL	Select to display selected menu items in normal size.
2x	Select to display selected menu items at twice the normal height.

→ continued

## LANGUAGE

You can select or change the language used for the on-screen display (p. 19). You can select from English, Simplified English, Canadian-French, Latin American Spanish, Brazilian-Portuguese, Traditional-Chinese, or Korean.

## DEMO MODE

When you remove a cassette from your camcorder, and select the CAMERA mode, you can view the demonstration in about 10 minutes.

---

▷ON	Select to see an overview of the functions available such as when you are using this camcorder for the first time.
OFF	Select when you do not intend to use the [DEMO MODE].

---

### Note

- You can view the demonstration only when the NIGHTSHOT PLUS switch is set to OFF.

### Tips

- The demonstration will be suspended in situations such as those described below.
  - When a cassette is inserted.
  - When a mode other than CAMERA is selected.
- If [A.SHUT OFF] is set to [5 min] when the camcorder is used on the battery pack, the power will be turned off after approximately 5 minutes (p. 57).



# Using the ETC (OTHERS) menu – WORLD TIME/VIDEO EDIT, etc.

power mode of your camcorder. The screen shows the items you can operate at the moment. Unavailable items will be grayed out.

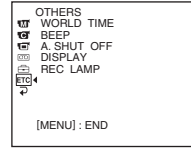

You can select items listed below in the OTHERS menu. To select items, see “Changing the menu settings” (p. 41).  
The default settings are marked with ▷. The settings you can adjust vary depending on the

## DATA CODE

For **TRV280**:

▷OFF	Select not to display date, time and the camera settings data during playback.
DATE/TIME	Select to display the date and time during playback. (p. 37)
CAM DATA	Select to display the camera setting data during playback. (p. 37)

## WORLD TIME

You can adjust the time difference when using your camcorder abroad. Set the time difference by turning the SEL/PUSH EXEC dial, the clock will be adjusted in accordance with the time difference. If you set the time difference to 0, the clock returns to the originally set time.

## BEEP

▷MELODY	Select to play a melody when you start/stop recording, operate your camcorder with the SEL/PUSH EXEC dial, or when an unusual condition occurs on your camcorder.
NORMAL	Select to sound a beep instead of the melody.
OFF	Select to cancel the melody, beep sound, shutter sound and operation confirmation beep.

## A.SHUT OFF

▷5 min	Select to activate the Auto shut off. When approximately 5 minutes have elapsed while you do not operate your camcorder, the camcorder is automatically turned off to prevent the battery from becoming consumed.
NEVER	Select to deactivate the Auto shut off.

→ continued

**Note**

- When you connect your camcorder to the wall outlet, [A.SHUT OFF] is automatically set to [NEVER].

## DISPLAY

---

▷LCD	Select to show the displays such as the time code on the LCD screen and in the viewfinder.
V-OUT/LCD	Select to show the displays such as the time code on the TV screen, LCD screen, and in the viewfinder.

---

## REC LAMP

---

▷ON	Select to turn on the camera recording lamp on the front of your camcorder during recording.
OFF	Select this setting in the following recording situations. The camera recording lamp will not light up during recording. <ul style="list-style-type: none"><li>• When you do not want the subject to be nervous about being recorded.</li><li>• When you are recording close to the subject.</li><li>• When the subject reflects the recording lamp.</li></ul>

---

## VIDEO EDIT

For **TRV280**:

You can select up to 20 scenes (programs) and record them in the desired order to another recording device such as VCR (p. 67).

# Connecting to a VCR

You can create a copy of the picture recorded on your camcorder on other recording devices (p. 61).  
For DVTRV280, you can also record the picture from a VCR to a tape on your camcorder (p. 66).  
Connect your camcorder to a VCR as shown in the following illustration.

For Hi8TRV138/338:

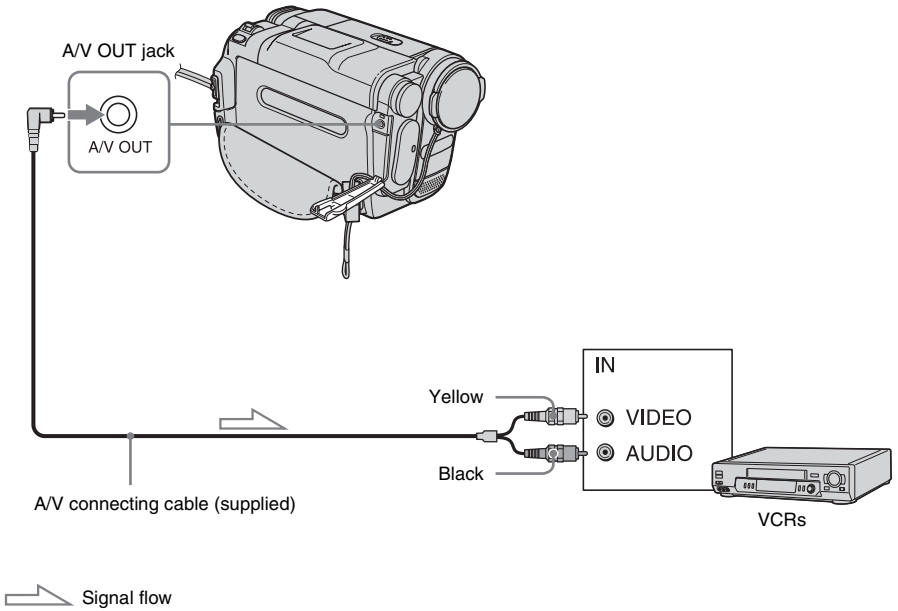

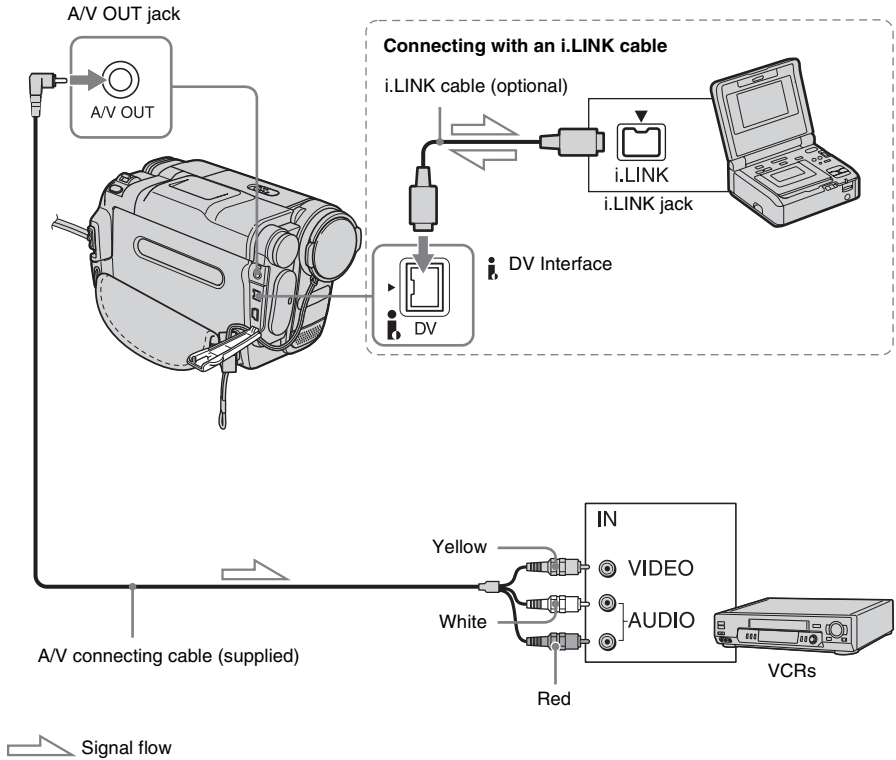

→ continued

## For TRV280:



### Notes

- Use the A/V connecting cable to connect your camcorder to other devices. Before connecting, make sure the [DISPLAY] setting in the  (OTHERS) menu is set to [LCD] (the default setting) (p. 58).
- For  TRV138/338:  
When you are connecting your camcorder to a stereo device, connect the audio plug of the A/V connecting cable to the left (white) jack on the VCR.
- For  TRV280:  
When you are connecting your camcorder to a monaural device, connect the yellow plug of the A/V connecting cable to the video jack, and the red (right channel) or the white (left channel) plug to the audio jack on the VCR.

### To use an i.LINK cable for connection

For  TRV280:

Use an i.LINK cable (optional) to connect your camcorder to other device via the DV Interface. The video and sound signals are transmitted digitally, producing high quality pictures. Note

that you cannot record the picture and sound separately. For details, see page 97.

# Dubbing to another tape

You can copy and edit the picture played back on your camcorder to other recording devices (such as VCRs).

## 1 Connect your VCR to your camcorder as a recording device (p. 59, 60).

## 2 Prepare your VCR for recording.

- Insert a cassette for recording.
- If your VCR has an input selector, set it to the input mode.

## 3 Prepare your camcorder for playback.

- Insert the recorded cassette.
- Slide the POWER switch to select the PLAY/EDIT mode.





## 4 Start the playback on your camcorder, and record it on the VCR.

Refer to the operating instructions supplied with your VCR for details.



## 5 When the dubbing is finished, stop your camcorder and the VCR.

### 🔊 Notes

- When dubbing using the A/V connecting cable, press DISPLAY/BATT INFO to hide indicators such as time code (p. 37). Otherwise, they will be recorded on the tape.
- For  TRV280: When connected using the A/V connecting cable, to record the date/time and camera settings data, have it displayed on screen (p. 37).

- For  TRV280: When your camcorder is connected to the VCR via the  DV Interface, you cannot record the title or indicators.
- For  TRV280: Pictures edited with Picture effect ([P EFFECT] p. 43) cannot be output via the  DV Interface.
- For  TRV280: When connected using the i.LINK cable, the recorded picture becomes rough when a picture is paused on your camcorder while recording to a VCR.

### 💡 Tip

- For  TRV138/338: To prevent deterioration of pictures, set [EDIT] to [ON] in the  (PLAYER SET) menu before dubbing (p. 49).

# Dubbing a tape easily

## – Easy Dubbing (Hi8 TRV138/338)

You can control VCR for dubbing with your camcorder easily with the VCR connected to the camcorder.

### Step 1: Preparing your camcorder and VCR for operation

Follow the steps below when you are performing the Easy Dubbing for the first time. You can skip this setting if you have set up the VCR by the following procedure before.

#### Note

- You cannot perform the Easy Dubbing on a VCR that does not support [IR SETUP] codes.

#### 1 Connect your VCR to your camcorder as a recording device (p. 60).

#### 2 Prepare your VCR for recording.

- Insert a cassette for recording.
- Set the input selector to input mode, if your VCR has one.

#### 3 Prepare your camcorder for playback.

- Insert a cassette for editing.
- Slide the POWER switch repeatedly to select the PLAY/EDIT mode.

#### 4 Press EASY DUB.

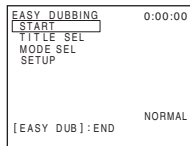

#### 5 Turn the SEL/PUSH EXEC dial to select [SETUP], then press the dial.

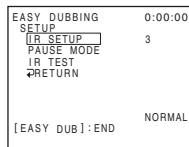

#### 6 Turn the SEL/PUSH EXEC dial to select [IR SETUP], then press the dial.

When you connect with an A/V connecting cable, you need to check the [IR SETUP] code signal to see if your VCR can be operated by your camcorder (infrared ray emitter).

#### 7 Turn the SEL/PUSH EXEC dial to select the [IR SETUP] code of your VCR, then press the dial.

For the [IR SETUP] code of your VCR, refer to "[IR SETUP] code list" (p. 63). When there is more than one code listed for the manufacturer of your VCR, try each code and find the most appropriate one.

#### 8 Turn the SEL/PUSH EXEC dial to select [PAUSE MODE], then press the dial.

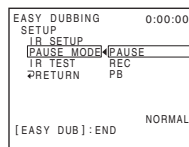

#### 9 Turn the SEL/PUSH EXEC dial to select the mode to cancel recording pause on the VCR, then press the dial.

Refer to the operating instructions supplied with your VCR for details on operation.

**10** Point the infrared ray emitter of your camcorder towards the remote sensor on your VCR, from about 30 cm (12 in.) away, with no obstructions.

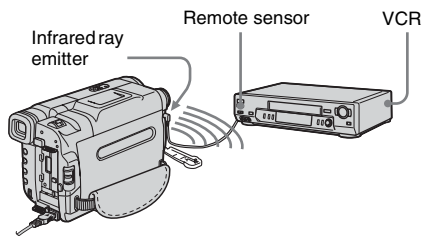

**11** Set the VCR to recording pause.

**12** Turn the SEL/PUSH EXEC dial to select [IR TEST], then press the dial.

**13** Turn the SEL/PUSH EXEC dial to select [EXECUTE], then press the dial.

Recording starts on your VCR when the setting is correct. [COMPLETE] appears when the [IR SETUP] code test is finished. Go on to the next step.

When recording fails to start, select another [IR SETUP] code and try again.

**14** Turn the SEL/PUSH EXEC dial to select [↩ RETURN], then press the dial.

## [IR SETUP] code list

The following [IR SETUP] codes are recorded on your camcorder by default. (It is set at "3" as the default setting.)

Manufacturing company	[IR SETUP] code
Sony	1, 2, 3, 4, 5, 6
Admiral (M. Wards)	89
Aiwa	47, 54, 80
Akai	49, 51
Audio Dynamic	21, 35
Bell&Howell (M. Wards)	36
Broksonic	21, 70, 82
Canon	77, 78
Citizen	47
Craig	47, 73
Curtis Mathis	8, 77, 80
Daewoo	26, 40, 77
DBX	21, 33, 35
Dimensia	8
Emerson	26, 48, 59, 70, 80, 81, 82
Fisher	36, 37, 44, 45
Funai	80
General Electric	8, 32*, 77, 94*, 101
Goldstar/LG	47
GO VIDEO	71
Hitachi	8, 42, 78
HQ	40
Instant Replay	77, 78
JC Penny	8, 21, 33, 35, 36, 42, 77
JVC	12, 13, 14, 21, 33, 35
Kenwood	21, 33, 35, 47
LXI (Sears)	36, 37, 42, 44, 45, 47, 49, 80
Magnavox	17, 77, 78, 83
Marantz	21, 33, 35
Marta	47
Memorex	37, 77
Minolta	8, 42
Mitsubishi/MGA	22, 23, 24, 28, 29

→ continued

Manufacturing company	[IR SETUP] code
Multitech	23, 32, 80
NEC	21, 33, 35
Olympic	77, 78
Optimus	22
Orion	60
Panasonic	16, 17, 77, 78
Pentax	8, 42
Philco	26, 70, 77, 78
Philips	47, 77, 78, 83
Pioneer	78
Quasar	6, 16, 17, 77, 78
RCA/PROSCAN	7, 8, 16, 40, 41, 42, 77, 78, 78*, 83, 101
Realistic	22, 36, 37, 77, 80, 88
Sansui	21
Singer	73
Samsung	24, 24*, 32, 32*, 41, 94, 94*
Sanyo	26, 36, 37, 47
Scott	22, 23, 24, 28, 32, 37, 40, 41
Sharp	88, 89
Shintom	73
Signature 2000	80, 89
Sylvania	77, 78, 80, 83
Symphonic	80
Tashiro	47
Tatung	21, 33, 35
Teac	21, 33, 35, 80
Technics	77, 78
Toshiba	7, 40, 49
Wards	37, 47, 88, 89, 95
Yamaha	21, 33, 35, 36
Zenith	95

\* TV/VCR component

## Step 2: Selecting the title

You can insert a title.

You can select one of the 8 preset titles and the 2 custom titles. See steps 1 to 4 on page 31 to create original titles.

- 1 Turn the SEL/PUSH EXEC dial to select [TITLE SEL], then press the dial.

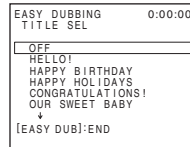

- 2 Turn the SEL/PUSH EXEC dial to select the desired title, then press the dial.

The title flashes.

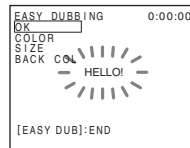

- 3 Change [COLOR] (color), [SIZE] (size), or [BACK COL.] (back ground color) as necessary.

If you do not need to change them, go to Step 3 (p. 65).

- 1 Turn the SEL/PUSH EXEC dial to select [COLOR], [SIZE], or [BACK COL.], then press the dial. The selected item appears on the screen.
- 2 Turn the SEL/PUSH EXEC dial to select the desired item, then press the dial.
- 3 Repeat steps 1 and 2 until the title is laid out as desired.



**4 Turn the SEL/PUSH EXEC dial to select [OK], then press the dial.**

The title lights up.

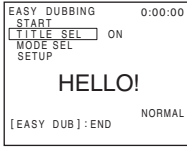

**⚡ Notes**

- You can put a title only into the tape of the VCR.
- If you set the background color to [FADE], the picture may not appear properly, depending on the connected VCR.

**💡 Tips**

- The title color changes as follows:  
[WHITE] ↔ [YELLOW] ↔ [VIOLET] ↔ [RED] ↔ [CYAN] ↔ [GREEN] ↔ [BLUE]
- The title size changes as follows:  
[SMALL] ↔ [LARGE]
- The background color changes as follows:  
[FADE] ↔ [WHITE] ↔ [YELLOW] ↔ [VIOLET] ↔ [RED] ↔ [CYAN] ↔ [GREEN] ↔ [BLUE] ↔ [BLACK]

**Step 3: Selecting the dubbing mode**

You can choose either normal recording ([NORMAL]) or interval recording ([PREVIEW]).

**1 Turn the SEL/PUSH EXEC dial to select [MODE SEL], then press the dial.**

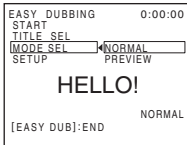

**2 Turn the SEL/PUSH EXEC dial to select [NORMAL] or [PREVIEW], then press the dial.**

**When you select [NORMAL]**

You can record into the VCR normally.

**When you select [PREVIEW]**

You can make a time-lapse dubbing by setting the VCR to automatically repeat 5 seconds' recording and 25 seconds' standby.

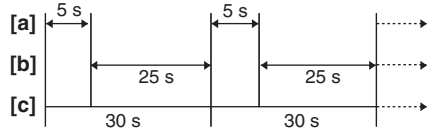

- Recording time (VCR)
- Waiting time (VCR)
- Playback time (camcorder)

**Step 4: Performing Easy Dubbing**

Make sure that your camcorder and VCR are connected, and that the VCR is set to recording pause.

**1 Turn the SEL/PUSH EXEC dial to select [START], then press the dial.**

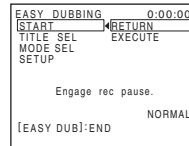

→ continued

---

## 2 Turn the SEL/PUSH EXEC dial to select [EXECUTE], then press the dial.

When dubbing ends, your camcorder and VCR stop automatically.  
Then the display returns to the Easy Dubbing initial screen.

---

### To stop dubbing during editing

Press  (stop) on your camcorder.

### To quit Easy Dubbing

Press EASY DUB.

#### Note

- [NOT READY] appears on the screen when [START] is not carried out.

---

# Recording pictures from a VCR (E) TRV280

You can record and edit pictures from a VCR on a tape inserted in your camcorder. Insert a cassette for recording in your camcorder.

#### Note

- Your camcorder can only record from an NTSC source. For example, European video or TV programs (PAL/SECAM) cannot be recorded correctly. See page 94 for details on TV color systems.

---

## 1 Connect your VCR to your camcorder (p. 60).

Use an i.LINK cable (optional) for connection.

---

## 2 Slide the POWER switch repeatedly to select the PLAY/EDIT mode.

---

## 3 Press (rec) and the button on its right simultaneously on your camcorder, then immediately press (pause) on your camcorder.

---

## 4 Start playing the cassette on your VCR.

The picture played on the connected device appears on the LCD screen of your camcorder.

---

## 5 Press (pause) at the point you want to start recording.

---

## 6 Press (stop) to stop recording.

---

#### Tip

- DV IN appears when you connect your camcorder and other devices via an i.LINK cable. (This indicator may also appear on your TV.)

# Dubbing selected scenes from a tape

– Digital program editing (E) TRV280

You can select up to 20 scenes (programs) and record them in the desired order to other recording device such as VCR.

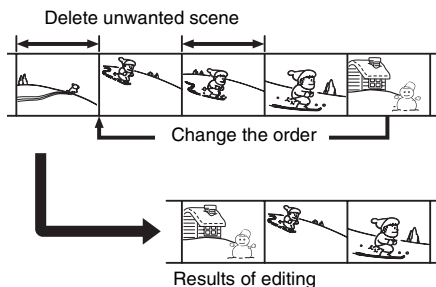

## Step 1: Preparing your camcorder and VCR for operation

Follow the steps below when you are performing digital program editing for the first time to a tape in a VCR. You can skip this setting if you have set up the VCR by the following procedure before.

### Notes

- You cannot perform the Digital program editing on the following devices:
  - a VCR that does not support [IR SETUP] codes
  - a DVD recorder, a DVD recorder equipped with an HDD, etc
- When your camcorder is connected to the VCR via the DV Interface, you cannot record the title or indicators.

## 1 Connect your VCR to the camcorder as a recording device (p. 60).

You can use either the A/V connecting cable or the i.LINK cable to make the connection. The dubbing procedure is easier with the i.LINK connection.

## 2 Prepare your VCR.

- Insert a cassette for recording.
- Set the input selector to input mode, if your VCR has one.

## 3 Prepare your camcorder (playing device).

- Insert a cassette for editing.
- Slide the POWER switch repeatedly to select the PLAY/EDIT mode.

## 4 Press MENU.

## 5 Turn the SEL/PUSH EXEC dial to select [ETC] (OTHERS), then press the dial.

## 6 Turn the SEL/PUSH EXEC dial to select [VIDEO EDIT], then press the dial.

```

VIDEO EDIT          0:08:55:06
[MARK]             1 IN
UNDO
ERASE ALL
START
EDIT SET

TOTAL 0:00:00:00
SCENE 0
#####
[MENU]: END
    
```

## 7 Turn the SEL/PUSH EXEC dial to select [EDIT SET], then press the dial.

```

VIDEO EDIT          0:08:55:06
EDIT SET
[CONTROL] IR
ADJ TEST
"CUT-IN"
"CUT-OUT"
IR SETUP
PAUSEMODE
IR TEST
[RETURN]
[MENU]: END
    
```

## 8 Turn the SEL/PUSH EXEC dial to select [CONTROL], then press the dial.

```

VIDEO EDIT          0:08:55:06
EDIT SET
[CONTROL] i.LINK
i.LINK

[MENU]: END
    
```

→ continued

- 
- 9 Turn the SEL/PUSH EXEC dial to select [i.LINK] or [IR], then press the dial.**

**When connecting with an i.LINK cable**

After selecting [i.LINK], go on to “Step 2: Adjusting the synchronization of the VCR” (p. 68).

**When connecting with an A/V connecting cable**

After selecting [IR], follow the procedure described in “To set the [IR SETUP] code” (p. 68).

---

**To set the [IR SETUP] code**

When you connect with an A/V connecting cable, you need to check the [IR SETUP] code signal to see if your VCR can be operated by your camcorder (infrared ray emitter).

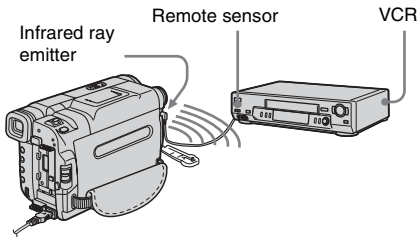

- 1 Turn the SEL/PUSH EXEC dial to select [IR SETUP], then press the dial.**

- 2 Turn the SEL/PUSH EXEC dial to select the [IR SETUP] code of your VCR, then press the dial.**

For the [IR SETUP] code of your VCR, refer to “[IR SETUP] code list” (p. 63). When there is more than one code listed for the manufacturer of your VCR, try each code and find the most appropriate one.

- 3 Turn the SEL/PUSH EXEC dial to select [PAUSEMODE], then press the dial.**

- 4 Turn the SEL/PUSH EXEC dial to select the mode to cancel recording pause on the VCR, then press the dial.**

Refer to the operating instructions supplied with your VCR for details on operation.

- 5 Point the infrared ray emitter of your camcorder towards the remote sensor on your VCR, from about 30 cm (12 in.) away, with no obstructions.**

- 6 Insert a cassette into your VCR, and set the VCR to recording pause.**

- 7 Turn the SEL/PUSH EXEC dial to select [IR TEST], then press the dial.**

- 8 Turn the SEL/PUSH EXEC dial to select [EXECUTE], then press the dial.**

The recording starts on your VCR when the setting is correct. [COMPLETE] appears when the [IR SETUP] code test is finished. Go on to “Step 2: Adjusting the synchronization of the VCR” (p. 68).

When recording fails to start, select another IR code and try again.

---

## Step 2: Adjusting the synchronization of the VCR

Follow the steps below when you are performing digital program editing for the first time to a tape in a VCR. You can skip this setting if you have set up your VCR before using the following procedure. You can adjust the synchronization of your camcorder and the VCR to avoid not recording the starting scene.

- 
- 1 Remove the cassette from your camcorder. Prepare a pen and paper to take notes.**

- 
- 2 Set the VCR to recording pause mode.** Skip this step if you have selected [i.LINK] in step 9 on p. 68.

**Note**

- Run the tape for about 10 seconds before pausing. The starting scenes may not get recorded when you start recording from the beginning of the tape.

- 3** Turn the SEL/PUSH EXEC dial to select [ADJ TEST], then press the dial.

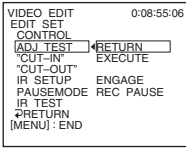

- 4** Turn the SEL/PUSH EXEC dial to select [EXECUTE], then press the dial. [EXECUTING] flashes and a picture (about 50 seconds long) with 5 [IN] and [OUT] indicators each for adjusting synchronization is recorded. [COMPLETE] appears when the recording is finished.

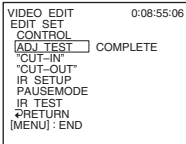

- 5** Rewind the tape on your VCR, then play back in slow mode. 5 opening numbers for each [IN] and closing numbers for each [OUT] appear.

- 6** Take a note of the opening numerical value of each [IN] and the closing number value of each [OUT], then calculate the average numerical value for each [IN] and [OUT].

- 7** Turn the SEL/PUSH EXEC dial to select [CUT-IN], then press the dial.

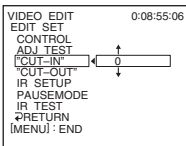

- 8** Turn the SEL/PUSH EXEC dial to select the average numerical value of [IN], then press the dial.

The calculated start position for recording is set.

- 9** Turn the SEL/PUSH EXEC dial to select [CUT-OUT], then press the dial.

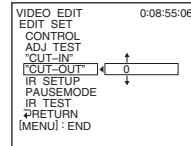

- 10** Turn the SEL/PUSH EXEC dial to select the average numerical value of [OUT], then press the dial.

The calculated stop position for recording is set.

- 11** Turn the SEL/PUSH EXEC dial to select [RETURN], then press the dial.

## Recording the selected scenes as programs

When you are performing digital program editing for the first time to a tape in a VCR, go through the procedures described in Steps 1 and 2 (p. 67 to p. 68) beforehand.

- 1** Prepare a cassette.

Insert a tape to be played back into the camcorder.

Insert a cassette for recording into your VCR.

→ continued

---

## 2 Press MENU.

---

## 3 Turn the SEL/PUSH EXEC dial to select [ETC] (OTHERS), then press the dial.

---

## 4 Turn the SEL/PUSH EXEC dial to select [VIDEO EDIT], then press the dial.

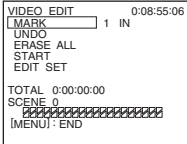

---

## 5 Search for the beginning of the first scene that you want to record on your camcorder, then pause playback.

---

## 6 Turn the SEL/PUSH EXEC dial to select [MARK], then press the dial.

The starting point of the first program is set, and the upper part of the program mark changes to light blue.

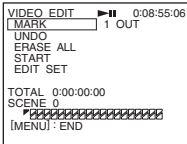

---

## 7 Search for the end of the first scene that you want to record on your camcorder, then pause playback.

---

---

## 8 Press the SEL/PUSH EXEC dial.

The ending point of the first program is set, and the lower part of the program mark changes to light blue.

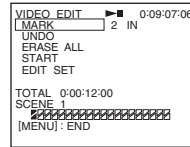

---

## 9 Repeat steps 5 to 8 and create programs.

---

## 10 Set your VCR to the recording pause.

Skip this step if your camcorder is connected via an i.LINK cable.

---

## 11 Turn the SEL/PUSH EXEC dial to select [START], then press the dial.

---

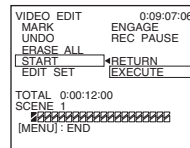

---

## 12 Turn the SEL/PUSH EXEC dial to select [EXECUTE], then press the dial.

A search for the beginning of the first program starts, then the recording starts. [SEARCH] appears during search and [EDITING] appears during editing.

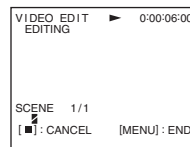

When a program is recorded, the program mark stops flashing and remains lit. When all programs have been recorded, the program editing operation stops automatically.

To cancel recording, press  (stop).

---

## To end Digital program editing

Press MENU.

## To save a program without using it to record

Press MENU in step 11.

The program is stored in memory until the cassette is ejected.

## To erase programs

- 1 Follow steps 1 to 4 in “Recording the selected scenes as programs” (p. 69).**
- 2 Turn the SEL/PUSH EXEC dial to select [UNDO] or [ERASE ALL], then press the dial.**

### When you select [UNDO]

You can erase the last set program.

### When you select [ERASE ALL]

You can erase all the programs.

- 3 Turn the SEL/PUSH EXEC dial to select [EXECUTE], then press the dial.**

The programs are deleted. To cancel this operation, select [RETURN], and then press the dial.

### ⚡ Notes

- You cannot set starting point or ending point on a blank section of the tape. If there is a blank section, the total time may not appear correctly.
- When you cannot operate the device correctly using an i.LINK cable connection, select [IR] in step 9 on p. 68, and set the [IR SETUP] code.

# Features

## (F) TRV280

When you install the Picture Package software on a Windows computer from the supplied CD-ROM, you can enjoy the following operations by connecting your camcorder to your computer.

Software and features available for Macintosh computers differ from those available for Windows computers. For details, refer to chapter 6 of “First Step Guide” on CD-ROM. For “First Step Guide,” see the next section.

### Tip

- There are 2 ways to connect your camcorder to a computer.
  - USB cable  
This method is good for copying video and sound recorded on a tape to the computer.
  - i.LINK cable  
This method is good for copying video and sound recorded on a tape. Image data is transferred in more clarity than with a USB cable.

For details on connection, see “First Step Guide.”

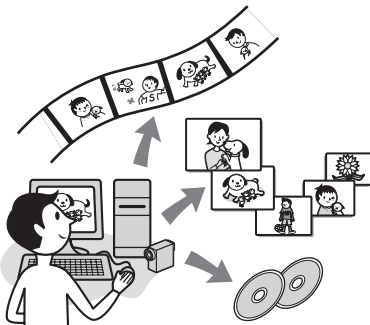

### Viewing video and pictures on a computer

You can view the pictures copied from your camcorder by selecting from thumbnails. Still images and movies are saved in folders by date.

### Music Video/Slideshow Producer

You can select your favorite movies and still images from pictures saved on your computer and easily create a short original video or slide show with added music and visual styles.

### Automatic Music Video Producer

You can easily create a short original video with added music and visual styles using pictures recorded on a tape.

### Copying tape to Video CD

You can import the entire contents of a tape to create a video CD.

### Save the images on CD-R

You can save pictures copied onto a computer to a CD-R.

### Burning Video CD

You can compose a video CD with a menu of videos and slide shows. ImageMixer VCD2 is compatible with high resolution still pictures.

### USB Streaming Tool

You can view the picture your camcorder is playing back on tape or is currently seeing on a computer.

### Video Capturing Tool

You can import the entire contents of a tape to a computer.

### The CD-ROM includes the following software.

- USB Driver
- Picture Package Ver.1.5
- ImageMixer VCD2
- “First Step Guide”



## About “First Step Guide”

“First Step Guide” is an instruction manual you can refer to on your computer. This “First Step Guide” describes basic operations, from initial hookup of your camcorder and computer and making settings, to general operation the first time you use the software stored on the CD-ROM (supplied). After installing the CD-ROM, reading “Installing the software and “First Step Guide” on a computer (▶ TRV280)” (p. 74), start the “First Step Guide,” then follow the instructions.

## About the help function of the software

The Help guide explains all the functions of all the software applications. Refer to the Help guide for further detailed operations after reading the “First Step Guide” thoroughly. To display the Help guide, click the [?] mark on the screen.

## System requirements

### For Windows users

#### When using Picture Package

- **OS:** Microsoft Windows 98, Windows 98SE, Windows 2000 Professional, Windows Millennium Edition, Windows XP Home Edition or Windows XP Professional Standard installation is required. Operation is not assured if the above OS has been upgraded. In Windows 98, USB Streaming is not supported. In Windows 98 and Windows 98SE, DV capturing is not supported.

- **CPU:** Intel Pentium III 500 MHz or faster (800 MHz or faster recommended) (For using ImageMixer VCD2, Intel Pentium III 800 MHz or faster recommended)
- **Application:** DirectX 9.0c or later (this product is based on DirectX technology. It is necessary to have DirectX installed.) Windows Media Player 7.0 or later Macromedia Flash Player 6.0 or later
- **Sound system:** 16 bit stereo sound card and stereo speakers
- **Memory:** 64 MB or more
- **Hard disk:** Available memory required for installation: 500 MB or more Available free hard disk space recommended: 6 GB or more (depending on the size of the image files edited)
- **Display:** 4 MB VRAM video card, Minimum 800 × 600 dots, High color (16 bit color, 65 000 colors), DirectDraw display driver capability (this product will not operate correctly at 800 × 600 dots or less, and 256 colors or less.)
- **Others:** USB port (this must be provided as standard), DV Interface (IEEE1394, i.LINK) (to connect via an i.LINK cable), disc drive (You need a CD-R drive to create a video CD. For the compatible drive, visit the following URL: <http://www.ppackage.com/>)

### For Macintosh users

#### ⚙ Note

- When you connect your camcorder to a Macintosh computer using a USB cable, you cannot copy pictures recorded on a tape to the computer. To copy recordings from a tape, connect your camcorder to the computer with an i.LINK cable and use the standard software in the OS.

#### When using ImageMixer VCD2

- **OS:** Mac OS X (v10.1.5 or later)
- **CPU:** iMac, eMac, iBook, PowerBook, PowerMac G3/G4/G5 series
- **Memory:** 128 MB or more
- **Hard disk:** Available memory required for installation 250 MB or more Available free hard disk space recommended: 4 GB or more (depending on the size of the image files edited)

→ *continued*

- **Display:** Minimum 1 024 × 768 dots, 32 000 colors (this product will not operate correctly at less than 1 024 × 768 dots or 256 colors.)
- **Application:** QuickTime 4 or later (QuickTime 5 recommended)
- **Other:** Disc drive

# Installing the software and “First Step Guide” on a computer

## (F) TRV280)

You need to install the software etc., with the supplied CD-ROM on your computer **before connecting your camcorder** and your computer. Once you install it, the installation is not required thereafter.

The software to be used varies depending on the OS system you are using.

Windows computer: Picture Package (including ImageMixer VCD2)

Macintosh computer: ImageMixer VCD2

For the details on the software, refer to “First Step Guide.”

## Installing on a Windows computer

### Tips

- To view “First Step Guide” on a Windows computer, Microsoft Internet Explorer Ver.6.0 or later is recommended. It may not be displayed correctly even in a recommended environment, depending on the setting of the browser. In this case, refer to it in PDF.
- When you want to print out “First Step Guide” or cannot install it in HTML format automatically in the desired language, refer to it in PDF.
- To view “First Step Guide” in PDF, copy the PDF file, stored in the desired language folder in [FirstStepGuide] folder on the CD-ROM, to your computer.
- When viewing “First Step Guide” in HTML on your computer without using automatic installation, copy the desired language folder from the [FirstStepGuide] folder on the CD-ROM, to your computer. You can refer to “First Step Guide” by double-clicking “index.html.”

## For Windows 2000/Windows XP

Log on as Administrators for installation.

**1 Confirm that your camcorder is not connected to the computer.**

**2 Turn on the computer.**

Close all applications running on the computer before installing the software.

**3 Place the CD-ROM in the disc drive of your computer.**

The installation screen appears.



If the screen does not appear

- 1 Double-click [My Computer].
- 2 Double-click [PICTUREPACKAGE] (Disc drive).\*

\*Drive names (such as (E:)) may vary depending on the computer.

**4 Click [Install].**



Depending on the operating system on the computer, a message appears notifying you that “First Step Guide” cannot be installed automatically with the InstallShield Wizard. In such a case, manually copy “First Step Guide” to your computer according to the message instructions.

**5 Select the language for the application to be installed, then click [Next].**

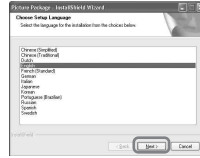

**6 Click [Next].**

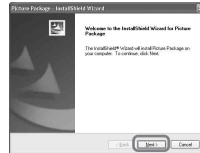

**7 Read [License Agreement], check [I accept the terms of the license agreement] when you agree, then click [Next].**



**8 Select where to save the software, then click [Next].**



→ continued

**9** Click [Install] on the [Ready to Install the Program] screen.

The installation of Picture Package starts.

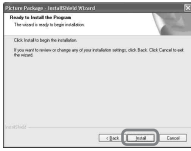

**10** Select the language for “First Step Guide” to be installed, then click [Next].

Depending on the computer, this screen may not be displayed. In such a case, skip to step 12.



**11** Click [Next] to install the “First Step Guide.”

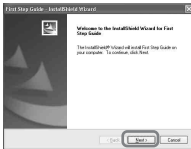

**12** Click [Next], then follow the on-screen instructions to install ImageMixer VCD2.



**13** If the [Installing Microsoft (R) DirectX(R)] screen is displayed, follow the steps below to install DirectX 9.0c. If not, skip to step 14.

**1** Read [License Agreement], then click [Next].



**2** Click [Next].



**3** Click [Finish].

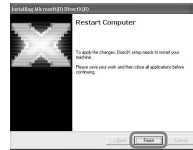

**14** Make sure [Yes, I want to restart my computer now.] is checked, then click [Finish].

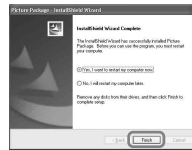

The computer turns off once, then starts up again automatically (Restart). The short-cut icons for [Picture Package Menu] and [Picture Package Menu destination Folder]

(and “First Step Guide,” if installed by steps 11-12) appear on the desktop.



---

**15** Remove the CD-ROM from the disc drive of your computer.

---

## If you have any questions about Picture Package

Contact information is listed on page 78.

## Installing on a Macintosh computer

- 1** Confirm that your camcorder is not connected to the computer.

---

- 2** Turn on the computer.  
Close all applications running on the computer before installing the software.

---

- 3** Place the CD-ROM in the disc drive of your computer.

---

- 4** Double-click CD-ROM icon.

---

- 5** Copy “FirstStepGuide.pdf,” stored in the desired language in the [FirstStepGuide] folder, to your computer.

---

- 6** Copy [IMXINST.SIT] in the [MAC] folder of the CD-ROM to a folder of your choice.

---

**7** Double-click [IMXINST.SIT] in the folder it was copied to.

---

**8** Double-click the unzipped [ImageMixerVCD2\_Install].

---

**9** When the user acceptance screen is displayed, enter your name and password.

The installation of ImageMixer VCD2 starts.

---

For details on how to use ImageMixer VCD2, refer to the software’s on-line help.

# Using “First Step Guide”

(F) TRV280

## Viewing “First Step Guide”

### Starting up on a Windows computer

Double-click the  icon on the desktop.

- You can also start by selecting [Start], [Programs] ([All Programs] for Windows XP), [Picture Package], and [First Step Guide], then start up [First Step Guide].

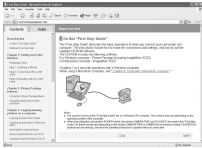

### Starting up on a Macintosh computer

Double-click “FirstStepGuide.pdf.”

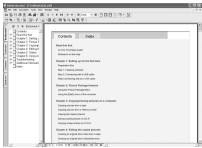

### Tip

- To view the PDF, Adobe Reader is needed. If it is not installed on your computer, you can download it from the Adobe Systems web page: <http://www.adobe.com/>

## For inquires about this software

### Pixela User Support Center

Pixela Home Page

Windows: <http://www.ppackage.com/>

Macintosh: <http://www.ImageMixer.com/>

- North America (Los Angeles) Telephone: +1-213-341-0163
- Europe (U.K.) Telephone: +44-1489-564-764
- Asia (Philippines) Telephone: +63-2-438-0090

### On Copyrights

Music works, sound recording or other third party musical contents you may acquire from CDs, the Internet or other sources (the “Music Contents”) are the copyrighted work of the respective owners thereof and are protected by copyright laws and other applicable laws of each country/region. Except to the extent expressly permitted by applicable laws, you are not permitted to use (including, without limitation, copying, modifying, reproducing, uploading, transmitting or placing to the external network accessible to the public, transferring, distributing, lending, licensing, selling and publishing) any of the Music Contents without obtaining authorization or approval of the respective owners thereof.

License of Picture Package by Sony Corporation would not be construed as conferring to you by implication, estoppel or otherwise, any license or right to use the Music Contents.

### On trademarks

- Adobe, the Adobe logo, and Adobe Acrobat are either registered trademarks or trademarks of Adobe Systems Incorporated in the United States and/or other countries.
- Picture Package is a trademark of Sony Corporation.
- Microsoft, Windows and Windows Media are either registered trademarks or trademarks of Microsoft Corporation in the United States and/or other countries.

- iMac, iBook, Macintosh, Mac OS, PowerBook and PowerMac are trademarks of Apple Computer, Inc., registered in the U.S. and other countries.
- eMac is a trademark of Apple Computer, Inc.
- QuickTime and the QuickTime logo are trademarks of Apple Computer, Inc.
- Roxio is a registered trademark of Roxio, Inc.
- Toast is a trademark of Roxio, Inc.
- Macromedia and Macromedia Flash Player are trademarks or registered trademarks of Macromedia, Inc. in the United States and/or other countries.
- Pentium is a trademark or registered trademark of Intel Corporation.

All other product names mentioned herein may be the trademarks or registered trademarks of their respective companies. Furthermore, “™” and “®” are not mentioned in each case in this manual.

## Creating a DVD (Direct Access to “Click to DVD”)

(F) TRV280)

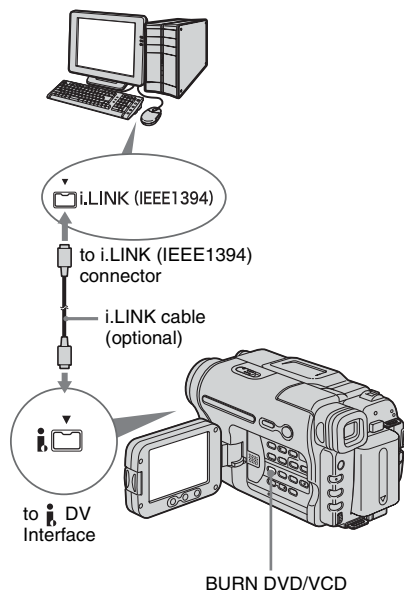

### Note

- You can only use an i.LINK cable for this operation. You cannot use a USB cable.

You can create DVDs when you connect your camcorder to a Sony VAIO series computer\* that supports “Click to DVD” via an i.LINK cable (optional). The picture is automatically copied and written to a DVD.

\* Note that you need a Sony VAIO computer equipped with a DVD drive that can be used to write DVDs. You also need the computer with “Click to DVD Ver.1.2” (Sony original software) or later installed.

The following procedures describe how to create a DVD from a picture recorded on a tape. For system and operation requirements, visit the following URL:

→ continued

- Europe  
<http://www.vaio-link.com/>
- USA  
<http://www.ita.sel.sony.com/support/dvimag/>
- Asia Pacific Regional  
<http://www.css.ap.sony.com/>
- Korea  
<http://scs.sony.co.kr/>
- Taiwan  
<http://vaio-online.sony.com/tw/vaio/>
- China  
<http://www.sonystyle.com.cn/vaio/>
- Thailand  
<http://www.sony.co.th/vaio/index.html>
- Latin America  
<http://vaio-online.sony.com/>

## Using the Direct Access to “Click to DVD” function for the first time

The Direct Access to “Click to DVD” function enables you to copy pictures recorded on a tape to a DVD easily if your camcorder is connected to a computer. Before operating the Direct Access to “Click to DVD” function, follow the steps below to start “Click to DVD Automatic Mode Launcher.”

- 1 Turn on the computer.**
- 2 Click the start menu, then select [All Programs].**
- 3 Select [Click to DVD] from the programs displayed, then click [Click to DVD Automatic Mode Launcher].**  
[Click to DVD Automatic Mode Launcher] starts up.

### Tips

- After you start up [Click to DVD Automatic Mode Launcher] once, from then on it starts up automatically when you turn on your computer.
- [Click to DVD Automatic Mode Launcher] is set up for each Windows XP user.

---

## 1 Turn on the computer.

Quit all applications running with an i.LINK.

---

## 2 Prepare the power source for your camcorder, then slide the POWER

**switch repeatedly to select the PLAY/EDIT mode.**

Use the supplied AC Adaptor as the power source since it takes a few hours to create a DVD.

---

## 3 Insert a recorded cassette into your camcorder.

---

## 4 Connect your camcorder to a computer via an i.LINK cable (optional).

### Note

- When you connect your camcorder to a computer, make sure you insert the connector in the correct direction. If you insert the connector forcibly, it may be damaged, and causes a malfunction of your camcorder. For details, see “First Step Guide.”

---

## 5 Press BURN DVD/VCD.

---

## 6 Turn the SEL/PUSH EXEC dial to select [DVD] on the [SELECT DISC], then press the dial.

“Click to DVD” starts up and the on-screen instructions appear on your computer.

---

## 7 Place a writable DVD in the disc drive of the computer.

---

## 8 Press the SEL/PUSH EXEC dial.

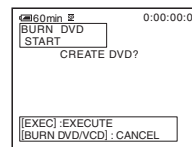

The status of the operation on your computer is displayed on the LCD screen of your camcorder.

**CAPTURING:** The picture recorded on the tape is being copied to the computer.

**CONVERTING:** The picture is being converted to the MPEG2 format.



**WRITING:** The picture is being written onto the DVD.

### Tip

- If you use a DVD-RW/+RW which has other data stored on it, the message [This is a recorded disc. Delete and overwrite?] appears on the LCD screen of your camcorder. When you press the SEL/PUSH EXEC dial, the existing data is erased and new data is written.

- You cannot operate your camcorder in the following situations:
  - While playing back a tape
  - When “Click to DVD” is started up from the computer
- You may not be able to create a DVD from an 8mm tape if it contains pictures recorded in a format other than Digital8 format.

---

## 9 Press BURN DVD/VCD to finish creating a DVD.

The disc tray comes out automatically.

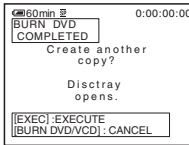

To create another DVD with the same content, press the SEL/PUSH EXEC dial. The disc tray comes out. Place a new writable DVD in the disc drive. Then, repeat steps 8 and 9.

---

## To cancel the operation

Press BURN DVD/VCD.

### Notes

- You cannot cancel the operation after [Finalizing DVD.] is displayed on the LCD screen of your camcorder.
- Do not disconnect the i.LINK cable or set the POWER switch to another mode on your camcorder until the picture is completely copied to the computer.
- The DVD is created even if you disconnect the i.LINK cable (optional) or turn off the power of your camcorder while [WRITING] or [CONVERTING] is displayed.
- When any of the following occurs, copying of the picture is canceled. A DVD containing the data up to the point the operation was canceled is created. Refer to the help files of “Click to DVD Automatic Mode Launcher” for details.
  - When there is a blank portion of 10 seconds or longer on the tape.
  - When the data of the tape contains a date before the recording date of the later images.
  - When normal and wide size pictures are recorded on the same tape.

# Troubleshooting

If you run into any problem using your camcorder, use the following table to troubleshoot the problem. If the problem

persists, remove the power source and contact your Sony dealer.

If “C:□□:□□” is displayed on the LCD screen or the viewfinder, the self-diagnosis display function is activated. See page 92 for details.

## Overall operations



Symptom	Cause and/or Corrective Actions
The power does not turn on.	<ul style="list-style-type: none"> <li>The battery pack is discharged, running low, or not attached to the camcorder.                             <ul style="list-style-type: none"> <li>→ Attach a charged battery pack to the camcorder. (p. 12)</li> <li>→ Use the AC Adaptor to connect to the wall outlet. (p. 15)</li> </ul> </li> </ul>
The camcorder does not operate even when the power is set to on.	<ul style="list-style-type: none"> <li>→ Disconnect the AC Adaptor from the wall outlet or remove the battery pack, then reconnect it after about 1 minute. If the functions still do not work, press the RESET button using a sharp-pointed object. (If you press the RESET button, all settings including the clock setting are reset.)</li> </ul>

## Batteries/Power sources

Symptom	Cause and/or Corrective Actions
The CHG (charge) lamp does not light while the battery pack is being charged.	<ul style="list-style-type: none"> <li>→ Attach the battery pack to the camcorder correctly. If the lamp still does not light up, then it indicates that no power is supplied from the wall outlet.</li> <li>The battery charge is completed. (p. 12)</li> </ul>
The CHG (charge) lamp flashes while the battery pack is being charged.	<ul style="list-style-type: none"> <li>→ Attach the battery pack to the camcorder correctly. If the problem persists, disconnect the AC Adaptor from the wall outlet and contact your Sony dealer. The battery pack may be damaged. (p. 12)</li> </ul>
The battery pack is quickly discharged.	<ul style="list-style-type: none"> <li>The temperature of the environment is too low, or the battery pack has not been charged enough. This is not a malfunction.                             <ul style="list-style-type: none"> <li>→ Fully charge the battery again. If the problem persists, replace the battery pack with a new one. It may be damaged. (p. 12, 96)</li> </ul> </li> </ul>
The remaining battery time indicator does not indicate the correct time.	<ul style="list-style-type: none"> <li>The temperature of the environment is too high or too low, or the battery pack has not been charged enough. This is not a malfunction.                             <ul style="list-style-type: none"> <li>→ Fully charge the battery again. If the problem persists, replace the battery pack with a new one. It may be damaged. (p. 12, 96)</li> </ul> </li> </ul>
The power turns off frequently although the remaining battery indicator indicates that the battery pack has enough power to operate.	<ul style="list-style-type: none"> <li>A problem has occurred in the remaining battery time indicator, or the battery pack has not been charged enough.                             <ul style="list-style-type: none"> <li>→ Fully charge the battery again to correct the indication. (p. 12)</li> </ul> </li> </ul>

Symptom	Cause and/or Corrective Actions
The power abruptly turns off.	<ul style="list-style-type: none"> <li>• [A.SHUT OFF] in the  (OTHERS) menu is set to [5 min]. (p. 57)</li> <li>→When approximately 5 minutes have elapsed while you do not operate your camcorder, the camcorder is automatically turned off. Slide the POWER switch down to turn the power on again. (p. 15) Or use the AC adaptor.</li> </ul>
A problem occurs when the camcorder is connected to the AC Adaptor.	→Turn off the power, and disconnect the AC Adaptor from the wall outlet. Then, connect it again.

## Cassette tapes

Symptom	Cause and/or Corrective Actions
Cassette cannot be ejected from the compartment.	<ul style="list-style-type: none"> <li>→Make sure the power source (battery pack or AC Adaptor) is connected correctly. (p. 12)</li> <li>→Remove the battery pack from the camcorder, then attach it again. (p. 12)</li> <li>→Attach a charged battery pack to the camcorder. (p. 12)</li> </ul>
Cassette is not ejected even when the cassette lid is open.	→Moisture condensation is starting in your camcorder. (p. 99)
The remaining tape indicator is not displayed.	→Set  [REMAIN] to [ON] in the  (TAPE SET) menu to always display the remaining tape indicator. (p. 53)

## LCD screen/viewfinder

Symptom	Cause and/or Corrective Actions
An unknown language appears on the screen.	→See page 19.
An unknown picture appears on the screen.	→The camcorder is in [DEMO MODE]. (The [DEMO MODE] is automatically displayed when you leave the camcorder for 10 minutes after selecting CAMERA without inserting a cassette.) Insert a cassette to cancel [DEMO MODE]. You can also set [DEMO MODE] to [OFF] in the menu. (p. 56)
An unknown indicator appears on the screen.	→Refer to the indicator list. (p. 108)
The picture in the viewfinder is not clear.	→Use the viewfinder lens adjustment lever to adjust the lens. (p. 16)
The picture in the viewfinder has disappeared.	→Close the LCD panel. The picture is not displayed in the viewfinder when the LCD panel is open. (p. 16)















→continued

## Recording

Symptom	Cause and/or Corrective Actions
The tape does not start when you press REC START/STOP.	<ul style="list-style-type: none"> <li>→Slide the POWER switch to turn on the CAMERA lamp. (p. 15)</li> <li>→The tape has reached the end. Rewind it, or insert a new cassette.</li> <li>→Set the write-protect tab to REC or insert a new cassette. (p. 95)</li> <li>→The tape is stuck to the drum due to moisture condensation. Remove the cassette and leave your camcorder for at least 1 hour, then re-insert the cassette. (p. 99)</li> </ul>
The power abruptly turns off.	<ul style="list-style-type: none"> <li>• [A.SHUT OFF] in the <b>ETC</b> (OTHERS) menu is set to [5 min]. (p. 57) <ul style="list-style-type: none"> <li>→When approximately 5 minutes have elapsed while you do not operate your camcorder, the camcorder is automatically turned off.</li> </ul> </li> <li>Slide the POWER switch down to turn the power on again (p. 15). Or use the AC Adaptor.</li> <li>• The battery pack is discharged. (p. 12)</li> </ul>
For <b>Hi8</b> TRV338/ <b>Hi8</b> TRV280: The SteadyShot does not function.	<ul style="list-style-type: none"> <li>→Set [STEADYSHOT] to [ON] in the <b>CS</b> (CAMERA SET) menu. (p. 48)</li> <li>→Set [16:9 WIDE] to [OFF] in the <b>CS</b> (CAMERA SET) menu. (p. 46)</li> </ul>
The auto focus does not function.	<ul style="list-style-type: none"> <li>→Press FOCUS to enable auto focus. (p. 29)</li> <li>→The recording conditions are not suitable for auto focus. Adjust the focus manually. (p. 29)</li> </ul>
A vertical band appears when recording candlelight or electric light in the dark.	<ul style="list-style-type: none"> <li>• This occurs when the contrast between the subject and the background is too high. This is not a malfunction.</li> </ul>
A vertical band appears when recording a bright subject.	<ul style="list-style-type: none"> <li>• This phenomenon is called the smear effect. This is not a malfunction.</li> </ul>
The color of the picture is not correctly displayed.	<ul style="list-style-type: none"> <li>→Deactivate the NightShot plus function. (p. 28)</li> </ul>
Picture appears too bright on the screen, and the subject does not appear on the screen.	<ul style="list-style-type: none"> <li>→Deactivate the NightShot plus function in bright places. (p. 28)</li> <li>→Cancel the back light function. (p. 27)</li> </ul>
The shutter sound is not heard.	<ul style="list-style-type: none"> <li>→Set [BEEP] to [MELODY] or [NORMAL] in the <b>ETC</b> (OTHERS) menu. (p. 57)</li> </ul>
For <b>Hi8</b> TRV338/ <b>Hi8</b> TRV280: Black bands appear when you record a TV screen or computer screen.	<ul style="list-style-type: none"> <li>→Set [STEADYSHOT] to [OFF] in the <b>CS</b> (CAMERA SET) menu. (p. 48)</li> </ul>
Flickering or changes in color occurs.	<ul style="list-style-type: none"> <li>→This occurs when recording pictures under a fluorescent lamp, sodium lamp, or mercury lamp in the soft portrait or sports lesson mode. Cancel [PROGRAM AE] in this case. (p. 42)</li> </ul>
END SEARCH does not work.	<ul style="list-style-type: none"> <li>• The cassette was ejected after recording.</li> <li>• The cassette is new and has nothing recorded.</li> </ul>
END SEARCH does not work correctly.	<ul style="list-style-type: none"> <li>• There is a blank section in the beginning or middle of the tape. This is not a malfunction.</li> </ul>

Symptom	Cause and/or Corrective Actions
The built-in light does not function.	<ul style="list-style-type: none"> <li>→ Press LIGHT repeatedly to select  .</li> <li>→ If the problem persists, contact your Sony dealer or local authorized Sony service facility.</li> </ul>

## Playback



Symptom	Cause and/or Corrective Actions
Cannot play back.	<ul style="list-style-type: none"> <li>→ If the tape has reached the end, rewind the tape. (p. 34)</li> </ul>
Horizontal lines appear on the picture. The displayed pictures are not clear or do not appear.	<ul style="list-style-type: none"> <li>→ Clean the head using the cleaning cassette (optional). (p. 99)</li> <li>• For  TRV138/338: <ul style="list-style-type: none"> <li>The television's video channel is not adjusted correctly.</li> <li>→ Adjust it. (p. 39)</li> </ul> </li> <li>→ For  TRV138/338: <ul style="list-style-type: none"> <li>Set [EDIT] to [OFF] in the  (PLAYER SET) menu. (p. 49)</li> </ul> </li> </ul>
No sound or only a low sound is heard.	<ul style="list-style-type: none"> <li>→ For  TRV280: <ul style="list-style-type: none"> <li>Set [HiFi SOUND] to [STEREO] in the  (VCR SET) menu. (p. 49)</li> <li>→ Turn up the volume. (p. 34)</li> </ul> </li> <li>→ For  TRV280: <ul style="list-style-type: none"> <li>In the  (VCR SET) menu, adjust [AUDIO MIX] from the [ST2] side until the sound is heard appropriately. (p. 50)</li> </ul> </li> <li>→ Make sure the black plug for  TRV138/338, or the red and white plugs for  TRV280 of the A/V connecting cable are connected. (p. 39)</li> </ul>
The sound breaks off.	<ul style="list-style-type: none"> <li>→ Clean the head using the cleaning cassette (optional). (p. 99)</li> </ul>
For  TRV280: "----" is displayed on the screen.	<ul style="list-style-type: none"> <li>• The tape you are playing was recorded without setting the date and time.</li> <li>• A blank section on the tape is being played.</li> <li>• The data code on a tape with a scratch or noise cannot be read.</li> </ul>
END SEARCH does not work.	<ul style="list-style-type: none"> <li>• The cassette was ejected after recording.</li> <li>• The cassette is new and has nothing recorded.</li> </ul>
END SEARCH does not work correctly.	<ul style="list-style-type: none"> <li>• There is a blank section in the beginning or middle of the tape. This is not a malfunction.</li> </ul>
For  TRV280: The picture does not appear on the screen when playing back a tape.	<ul style="list-style-type: none"> <li>• The tape is recorded in the Hi8 /standard 8 mm  system.</li> </ul>
Noises appear on the screen.	<ul style="list-style-type: none"> <li>• The tape was recorded in a TV color system other than that of your camcorder. (p. 94)</li> <li>• For  TRV138/338: <ul style="list-style-type: none"> <li>Noise may appear while playing back the tape in various modes. This is not a malfunction.</li> </ul> </li> </ul>

→ continued

## Dubbing/Editing

Symptom	Cause and/or Corrective Actions
Cannot dub correctly using the A/V connecting cable.	→Set [DISPLAY] to [LCD] in the <b>[ETC]</b> (OTHERS) menu. (p. 58)
For <b>[P]</b> TRV280: Pictures from connected devices are not displayed correctly.	<ul style="list-style-type: none"> <li>• The input signal is not NTSC. (p. 66)</li> </ul>
For <b>[P]</b> TRV280: Digital program editing does not function.	<ul style="list-style-type: none"> <li>→Set the input selector on the VCR correctly, then check the connection between your camcorder and the VCR. (p. 60)</li> <li>→When your camcorder is connected to a DV device that is not a Sony product via an i.LINK cable, select [IR] in step 9 of “Step 1: Preparing your camcorder and VCR for operation.” (p. 67)</li> <li>→Adjust the synchronization of the VCR. (p. 68)</li> <li>→Enter a correct [IR SETUP] code. (p. 63)</li> <li>→Select the mode used to cancel recording pause again. (p. 68)</li> <li>→Set your camcorder and the VCR more than 30 cm (12 in.) apart. (p. 68)</li> <li>• The program may not be set to a blank section on the tape.</li> <li>• You cannot perform the Digital program editing on a VCR that does not support [IR SETUP] codes, a DVD recorder and a DVD recorder equipped with an HDD, etc.</li> </ul>
For <b>[P]</b> TRV280: The VCR is not responding properly during Digital program editing when it is connected via an i.LINK cable.	<ul style="list-style-type: none"> <li>→While connecting via an i.LINK cable, select [IR] in step 9 of “Step 1: Preparing your camcorder and VCR for operation.” (p. 67)</li> <li>• You cannot perform the Digital program editing on a DVD recorder, a DVD recorder equipped with an HDD, etc.</li> </ul>
For <b>[Hi8]</b> TRV138/338: Easy Dubbing does not function.	<ul style="list-style-type: none"> <li>• Your VCR and/or video camera recorder is not set correctly. <ul style="list-style-type: none"> <li>→Make sure the input selector of the VCR is set to LINE. Also, make sure the power switch of the video camera recorder is set to VCR. (p. 62)</li> </ul> </li> <li>• The [IR SETUP] code or [PAUSE MODE] is not set correctly. <ul style="list-style-type: none"> <li>→ Select the correct [IR SETUP] code and [PAUSE MODE], according to your VCR. Then confirm VCR operation with the [IR TEST] function. (p. 62)</li> </ul> </li> </ul>

## Connecting to a computer





Symptom	Cause and/or Corrective Actions
For <b>▶▶</b> TRV280: The computer does not recognize your camcorder. <b>[USB]</b> <b>[i.LINK]</b>	<ul style="list-style-type: none"> <li>→ Disconnect the cable from the computer and camcorder, then connect it again firmly.</li> <li>→ Disconnect the USB device other than the keyboard, the mouse, and the camcorder from the computer.</li> <li>→ Disconnect the cable from the computer and camcorder, restart the computer, then connect them again correctly.</li> </ul>
For <b>▶▶</b> TRV280: An error message appears when you place the CD-ROM in your computer.	<ul style="list-style-type: none"> <li>→ Set the computer display as follows:               <ul style="list-style-type: none"> <li>– Windows: 800 × 600 dots or more, High Color (16 bits, 65 000 colors or more)</li> <li>– Macintosh: 1 024 × 768 dots or more, 32 000 colors or more</li> </ul> </li> </ul>
For <b>▶▶</b> TRV280: You cannot view the pictures the camcorder is seeing on the computer. <b>[USB]</b> <b>[i.LINK]</b>	<ul style="list-style-type: none"> <li>→ Disconnect the cable from the computer, turn on the camcorder, then connect it again.</li> <li>→ Slide the POWER switch to select the CAMERA mode, set <b>[USB STREAM]</b> to <b>[ON]</b> in the <b>[</b> (SETUP MENU). (p. 55) (Only when connecting to the Windows computer with a USB cable)</li> </ul>
For <b>▶▶</b> TRV280: You cannot view the pictures recorded on a tape on the computer. <b>[USB]</b> <b>[i.LINK]</b>	<ul style="list-style-type: none"> <li>→ Disconnect the cable from the computer, turn on the camcorder, then connect it again.</li> <li>→ Slide the POWER switch repeatedly to select the PLAY/EDIT mode, set <b>[USB STREAM]</b> to <b>[ON]</b> in the <b>[</b> (SETUP MENU). (p. 55) (Only when connecting to the Windows computer with a USB cable)</li> </ul>
For <b>▶▶</b> TRV280: You cannot view the pictures recorded on a tape on the Macintosh computer. <b>[USB]</b>	<ul style="list-style-type: none"> <li>→ When you connect your camcorder to a Macintosh computer using a USB cable, you cannot copy pictures recorded on a tape to the computer. To copy recordings from a tape, connect your camcorder to the computer with an i.LINK cable and use the standard software in the OS.</li> </ul>

Symptom	Cause and/or Corrective Actions
<p>For <b>TRV280</b>: The image does not appear on the screen of the Windows computer when using the USB cable. <b>USB</b></p>	<p>→The USB driver has been registered incorrectly as the computer was connected to your camcorder before the installation of the USB driver was completed. Follow the procedure below to install the USB driver correctly.</p> <p><b>For Windows 98*/Windows 98SE/Windows Me</b> * When copying or playing the pictures on a tape using a computer, the operation is not guaranteed on Windows 98.</p> <ol style="list-style-type: none"> <li><b>1 Check that your camcorder is connected to a computer.</b></li> <li><b>2 Right-click [My Computer], then click [Properties].</b> The [System Properties] screen appears.</li> <li><b>3 Click the [Device Manager] tab.</b></li> <li><b>4 If devices below are already installed, right-click them, then click [Remove] to delete them.</b></li> </ol> <p><b>For copying and viewing pictures recorded on a tape</b></p> <ul style="list-style-type: none"> <li>• [USB Audio Device] in the [Sound, video and game controllers] folder</li> <li>• [USB Device] in the [Other devices] folder</li> <li>• [USB Composite Device] in the [Universal Serial Bus Controller] folder</li> </ul> <ol style="list-style-type: none"> <li><b>5 When the [Confirm Device Removal] screen appears, click [OK].</b></li> <li><b>6 Turn off the power of your camcorder, disconnect the USB cable, then restart the computer.</b></li> <li><b>7 Place the CD-ROM in the disc drive of your computer.</b></li> <li><b>8 Follow the steps below and try to install the USB driver again.</b> <ol style="list-style-type: none"> <li><b>1</b> Double-click [My Computer].</li> <li><b>2</b> Right-click [PICTUREPACKAGE] (Disc drive)*. * Drive names (such as (E:)) may vary depending on the computer.</li> <li><b>3</b> Click [Open].</li> <li><b>4</b> Double-click [Driver].</li> <li><b>5</b> Double-click [Setup.exe].</li> </ol> </li> </ol> <p><b>Note</b></p> <ul style="list-style-type: none"> <li>• Deleting anything other than [USB Audio Device], [USB Device], and [USB Composite Device] may cause malfunction of your computer.</li> </ul>



Symptom	Cause and/or Corrective Actions
<p>For <b>TRV280</b>:                      The image does not appear on the screen of the Windows computer when using the USB cable. <b>USB</b></p>	<p><b>For Windows 2000</b>                      Log on as Administrators.</p> <ol style="list-style-type: none"> <li><b>1 Check that your camcorder is connected to a computer.</b></li> <li><b>2 Right-click [My Computer], then click [Properties].</b>                      The [System Properties] screen appears.</li> <li><b>3 Click the [Hardware] tab.</b></li> <li><b>4 Click [Device Manager].</b></li> <li><b>5 Click [View], then click [Devices by type].</b></li> <li><b>6 If devices below are already installed, right-click them, then click [Uninstall] to delete them.</b></li> </ol> <p><b>For copying and viewing pictures recorded on a tape</b></p> <ul style="list-style-type: none"> <li>• [USB Composite Device] in the [Universal Serial Bus Controller] folder</li> <li>• [USB Audio Device] in the [Sound, video and game controller] folder</li> <li>• [Composite USB Device] in the [Other devices] folder</li> </ul> <ol style="list-style-type: none"> <li><b>7 When the [Confirm Device Removal] screen appears, click [OK].</b></li> <li><b>8 Turn off the power of your camcorder, disconnect the USB cable, then restart the computer.</b></li> <li><b>9 Place the CD-ROM in the disc drive of your computer.</b></li> <li><b>10 Follow the steps below and try to install the USB driver again.</b> <ol style="list-style-type: none"> <li><b>1 Double-click [My Computer].</b></li> <li><b>2 Right-click [PICTUREPACKAGE] (Disc drive)*.</b>                      * Drive names (such as (E:)) may vary depending on the computer.</li> <li><b>3 Click [Open].</b></li> <li><b>4 Double-click [Driver].</b></li> <li><b>5 Double-click [Setup.exe].</b></li> </ol> </li> </ol> <p><b>Note</b></p> <ul style="list-style-type: none"> <li>• Deleting anything other than [USB Composite Device], [USB Audio Device], and [Composite USB Device] may cause malfunction of your computer.</li> </ul>

→ continued

Symptom	Cause and/or Corrective Actions
<p>For  TRV280: The image does not appear on the screen of the Windows computer when using the USB cable. </p>	<p><b>For Windows XP</b> Log on as Administrators.</p> <ol style="list-style-type: none"> <li><b>1 Check that your camcorder is connected to a computer.</b></li> <li><b>2 Click [Start].</b></li> <li><b>3 Right-click [My Computer], then click [Properties].</b> The [System Properties] screen appears.</li> <li><b>4 Click the [Hardware] tab.</b></li> <li><b>5 Click [Device Manager].</b></li> <li><b>6 Click [View], then click [Devices by type].</b></li> <li><b>7 If devices below are already installed, right-click them, then click [Uninstall] to delete them.</b></li> </ol> <p><b>For copying and viewing pictures recorded on a tape</b></p> <ul style="list-style-type: none"> <li>• [USB Composite Device] in the [Universal Serial Bus Controller] folder</li> <li>• [USB Audio Device] in the [Sound, video and game controllers] folder</li> <li>• [USB Device] in the [Other devices] folder</li> </ul> <ol style="list-style-type: none"> <li><b>8 When the [Confirm Device Removal] screen appears, click [OK].</b></li> <li><b>9 Turn off the power of your camcorder, disconnect the USB cable, then restart the computer.</b></li> <li><b>10 Place the CD-ROM in the disc drive of your computer.</b></li> <li><b>11 Follow the steps below and try to install the USB driver again.</b> <ol style="list-style-type: none"> <li><b>1</b> Double-click [My Computer].</li> <li><b>2</b> Right-click [PICTUREPACKAGE] (Disc drive)*. * Drive names (such as (E:)) may vary depending on the computer.</li> <li><b>3</b> Click [Open].</li> <li><b>4</b> Double-click [Driver].</li> <li><b>5</b> Double-click [Setup.exe].</li> </ol> </li> </ol> <p> <b>Note</b></p> <ul style="list-style-type: none"> <li>• Deleting anything other than [USB Composite Device], [USB Audio Device], and [USB Device] may cause malfunction of your computer.</li> </ul>
<p>For  TRV280: [Cannot start Easy Handycam with USB connected] appears on the screen of your camcorder. </p>	<p>→ You cannot start the simple operation settings while the USB cable is connected. Disconnect the USB cable from your camcorder first.</p>

Symptom	Cause and/or Corrective Actions
<p>For <b>▶</b> TRV280: There is no sound when the camcorder is connected to the Windows computer via a USB cable. <b>[USB]</b></p>	<p>→Change the settings for your computer environment as described in the following procedures:</p> <ol style="list-style-type: none"> <li><b>1 Select [Start], [Programs] ([All Programs] for Windows XP), [Picture Package], [Handycam Tools], and [USB Streaming Tool], then start up [USB Streaming Tool].</b></li> <li><b>2 Select another device on the [Select audio device] screen.</b></li> <li><b>3 Follow the on-screen instructions, click [Next], then click [Done].</b></li> </ol> <p><b>🔊 Note</b></p> <ul style="list-style-type: none"> <li>• Sound is not supported on Windows 98.</li> </ul>
<p>For <b>▶</b> TRV280: The movie is not smooth during USB streaming. <b>[USB]</b></p>	<p>→Change the settings as described in the following procedures:</p> <ol style="list-style-type: none"> <li><b>1 Select [Start], [Programs] ([All Programs] for Windows XP), [Picture Package], [Handycam Tools], and [USB Streaming Tool], then start up [USB Streaming Tool].</b></li> <li><b>2 Adjust the slider in the (-) direction on [Select video quality].</b></li> <li><b>3 Follow the on-screen instructions, click [Next], then click [Done].</b></li> </ol>
<p>For <b>▶</b> TRV280: Picture Package does not function correctly.</p>	<p>→Close Picture Package, then restart the Windows computer.</p>
<p>For <b>▶</b> TRV280: An error message appears while operating Picture Package.</p>	<p>→Close Picture Package on your Windows computer first, then set the POWER switch on your camcorder to another mode.</p>
<p>For <b>▶</b> TRV280: The CD-R drive is not recognized or data cannot be written on the CD-R in Picture Package Auto Video, Producer, CD Backup or VCD Maker.</p>	<p>→For the compatible drive, visit the following URL: <a href="http://www.ppackage.com/">http://www.ppackage.com/</a></p>
<p>For <b>▶</b> TRV280: “First Step Guide” is not displayed correctly.</p>	<p>→Refer to “First Step Guide” in PDF. For copying the PDF file, see page 78.</p>

# Warning indicators and messages

## Self-diagnosis display/Warning indicators

If indicators appear on the screen, check the following. See the page in parentheses for details.











Indication	Cause and/or Corrective Actions
C:□□ : □□/E:□□ : □□ (Self-diagnosis display)	<p>Some symptoms can be fixed by yourself. If the problem persists even after you tried a couple of times, contact your Sony dealer or local authorized Sony service facility.</p> <p><b>C:04:□□</b>            → A battery pack that is not an “InfoLITHIUM” battery pack is being used. Use an “InfoLITHIUM” battery pack. (p. 96)</p> <p><b>C:21:□□</b>            → Moisture condensation has occurred. Remove the cassette and leave your camcorder for at least 1 hour, then re-insert the cassette. (p. 99)</p> <p><b>C:22:□□</b>            → Clean the head using a cleaning cassette (optional). (p. 99)</p> <p><b>C:31:□□ / C:32:□□</b>            → Symptoms that are not described above have occurred. Remove and insert the cassette, then operate your camcorder again. Do not perform this procedure if moisture starts to condense. (p. 98)</p> <p>→ Remove the power source. Reconnect it again and operate your camcorder again.</p> <p>→ Change the tape.</p> <p>→ Press the RESET button and operate your camcorder again.</p> <p><b>E:61:□□ / E:62:□□</b>            → Contact your Sony dealer or local authorized Sony service facility. Inform them of the 5-digit code, which starts from “E.”</p>
⊠ (Battery level warning)	<ul style="list-style-type: none"> <li>• The battery pack is nearly used up.</li> <li>• Depending on the operating, environmental, or battery conditions, the ⊠ indicator may flash, even if there are approximately 5 to 10 minutes remaining.</li> </ul>
⊠ (Moisture condensation warning)*	<p>→ Eject the cassette, set the POWER switch to (CHG) OFF, and leave it for about 1 hour with the cassette lid open. (p. 99)</p>
⊠ (Warning indicator pertaining to the tape)	<p><b>Slow flashing:</b></p> <ul style="list-style-type: none"> <li>• There is less than 5 minutes remaining on the tape.</li> <li>• No cassette is inserted.*</li> <li>• The write-protect tab on the cassette is set to lock. (p. 95)*</li> </ul> <p><b>Fast flashing:</b></p> <ul style="list-style-type: none"> <li>• The tape has run out.*</li> </ul>

Indication	Cause and/or Corrective Actions
 (Eject cassette warning)*	<b>Slow flashing:</b> <ul style="list-style-type: none"> <li>The write-protect tab on the cassette is set to lock. (p. 95)</li> </ul> <b>Fast flashing:</b> <ul style="list-style-type: none"> <li>Moisture condensation has occurred. (p. 99)</li> <li>The self-diagnosis display code is displayed. (p. 92)</li> </ul>

\* You hear a melody or beep sound when the warning indicators appear on the screen.

## Warning messages

The following messages will appear to prompt you to correct the situation.

Subjects	Indications	Corrective Actions/References
<b>Battery</b>	Use the “InfoLITHIUM” battery pack.	→See page 96.
	Battery level is low.	→Charge the battery. (p. 12)
	Old battery. Use a new one.	→See page 96
	 Re-attach the power source.	–
<b>Moisture condensation</b>	  Moisture condensation. Eject the cassette	→See page 99.
	 Moisture condensation. Turn off for 1H.	→See page 99.
<b>Cassette/tape</b>	 Insert a cassette.	→See page 18.
	 Reinsert the cassette.	→The cassette might be damaged, etc.
	  The tape is locked - check the tab.	→See page 95.
	 The tape has reached the end.	–
<b>Others</b>	Cannot record due to copyright protection.	–
	 Dirty video head. Use a cleaning cassette.	→See page 99.
	Cannot start Easy Handycam	→See page 26 and 36.
	Cannot cancel Easy Handycam	→See page 26 and 36.
	Cannot start Easy Handycam with USB connected	–
	Invalid button with Easy Handycam operation	→See page 26 and 36.
	USB invalid during Easy Handycam	→Press SEL/PUSH EXEC dial.

# Using your camcorder abroad

## Power supply

You can use your camcorder in any country/region using the AC Adaptor supplied with your camcorder within AC 100 V to 240 V, 50/60 Hz.

Use a commercially available AC plug adaptor [a], if necessary, depending on the design of the wall outlet [b].



## Simple setting of clock by time difference



You can easily set the clock to the local time by setting a time difference when using your camcorder abroad. Select [WORLD TIME] in the [ETC] (OTHERS) menu, then set the time difference (p. 57).

## On TV color systems



Your camcorder is an NTSC system-based camcorder. If you want to view the playback picture on a TV, it must be an NTSC system-based TV (see following list) with the AUDIO/VIDEO input jack.

System	Used in
NTSC	Bahama Islands, Bolivia, Canada, Central America, Chile, Colombia, Ecuador, Guyana, Jamaica, Japan, Korea, Mexico, Peru, Surinam, Taiwan, the Philippines, the U.S.A., Venezuela, etc.
PAL	Australia, Austria, Belgium, China, Czech Republic, Denmark, Finland, Germany, Holland, Hong Kong, Hungary, Italy, Kuwait, Malaysia, New Zealand, Norway, Poland, Portugal, Singapore, Slovak Republic, Spain, Sweden, Switzerland, Thailand, United Kingdom, etc.
PAL - M	Brazil
PAL - N	Argentina, Paraguay, Uruguay
SECAM	Bulgaria, France, Guiana, Iran, Iraq, Monaco, Russia, Ukraine, etc.

# Usable cassette tapes



You can use standard 8 mm  and Hi8 , Digital8  video cassettes on your camcorder.





## Hi8 system

This Hi8  system is an extension of the standard 8 mm  system, and was developed to produce higher quality pictures.

You cannot play back a tape recorded in the Hi8  system correctly on video recorders/players other than a Hi8 video recorder/player.

## Digital8 system

This video system has been developed to enable digital recording to Hi8 /Digital8  video cassette.

The recording time when you use your Digital8  system camcorder on Hi8 /standard 8 mm  tape is half the recording time when using the conventional Hi8 /standard 8 mm  system camcorder. (120 minutes of recording time becomes 60 minutes in the SP mode.)

## To prevent a blank section from being made on the tape

Press END SEARCH to go to the end of the recorded section before you begin the next recording in the case you have played back the tape.

If there is a blank section or discontinuous signals on your tape, re-record from the beginning to the end of the tape as described above.

## Copyright signal

### When you play back

If the cassette you play back on your camcorder contains copyright signals, you cannot copy it to a tape in another video camera connected to your camcorder.

For TRV280:

### When you record

**You cannot record software on your camcorder that contains copyright**

## control signals for copyright protection of software.

[Cannot record due to copyright protection.] appears on the LCD screen, or on the TV screen if you try to record such software.

Your camcorder does not record copyright control signals on the tape when it records.

## Notes on use

### To prevent accidental erasure

Slide the write-protect tab on the cassette to set to SAVE.

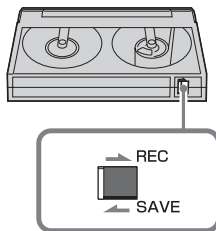

REC: The cassette can be recorded.

SAVE: The cassette cannot be recorded (write-protected).

## When labeling the cassette

Be sure to place the label only on the locations as shown in the following illustration so as not to cause malfunction of your camcorder.

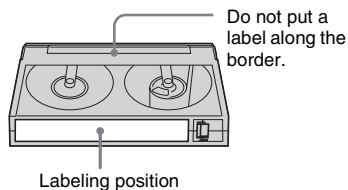

## After using the cassette

Rewind the tape to the beginning to avoid distortion of the picture or the sound. The cassette should then be put in its case, and stored in an upright position.

videoHi8, Digital8, , Hi8 and  are trademarks.

# About the “InfoLITHIUM” battery pack

This unit is compatible with the “InfoLITHIUM” battery pack (M series). Your camcorder operates only with the “InfoLITHIUM” battery pack. “InfoLITHIUM” M series battery packs have the  mark.

## What is the “InfoLITHIUM” battery pack?

The “InfoLITHIUM” battery pack is a lithium-ion battery pack that has functions for communicating information related to operating conditions between your camcorder and an optional AC Adaptor/charger.

The “InfoLITHIUM” battery pack calculates the power consumption according to the operating conditions of your camcorder, and displays the remaining battery time in minutes. With an AC Adaptor/charger (optional), the remaining battery time and charging time appear.

## To charge the battery pack

- Be sure to charge the battery pack before you start using your camcorder.
- We recommend charging the battery pack in an ambient temperature of between 10°C to 30°C (50°F to 86°F) until the CHG (charge) lamp turns off. If you charge the battery pack outside of this temperature range, you may not be able to charge it efficiently.
- After charging is complete, either disconnect the cable from the DC IN jack on your camcorder or remove the battery pack.

## To use the battery pack effectively

- Battery pack performance decreases when the surrounding temperature is 10°C (50°F) or below, and the length of time you can use the battery pack becomes shorter. In that case, do one of the following to use the battery pack for a longer time.

- Put the battery pack in a pocket to warm it up, and insert it in your camcorder right before you start taking shots.
- Use a large capacity battery pack: NP-QM71D/QM91D (optional).
- Frequent use of the LCD screen or a frequent playback, fast forward or rewind operation wears out the battery pack faster. We recommend using a large capacity battery pack: NP-QM71D/QM91D (optional).
- Be sure to set the POWER switch to (CHG) OFF when not recording or playing back on your camcorder. The battery pack is also consumed when your camcorder is in recording standby or playback pause.
- Have spare battery packs ready for two or three times the expected recording time, and make trial recordings before making the actual recording.
- Do not expose the battery pack to water. The battery pack is not water resistant.

## About remaining battery time indicator

- When the power goes off even though the remaining battery time indicator indicates that the battery pack has enough power to operate, charge the battery pack fully again. The indication on the remaining battery time will be indicated correctly. Note, however, that the battery indication will not be restored if it is used in high temperatures for a long time, or if left in a fully charged state, or when the battery pack is frequently used.  
Use the remaining battery time indication as a guide to the approximate shooting time.
- The  mark that indicates low battery flashes even if there are still 5 to 10 minutes of battery time remaining, depending on the operating conditions or ambient temperature and environment.

## About storage of the battery pack

- If the battery pack is not used for a long time, fully charge the battery pack and use it on your camcorder once a year to maintain proper function.  
To store the battery pack, remove it from your camcorder and put it in a dry, cool place.
- To completely use up the battery pack on your camcorder, set [A.SHUT OFF] to [NEVER] in the  (OTHERS) menu (p. 57) and leave



your camcorder in tape recording standby until the power goes off.

## About battery life

- The battery life is limited. Battery capacity drops little by little as you use it more and more, and as time passes. When the available battery time is shortened considerably, a probable cause is that the battery pack has reached the end of its life. Please buy a new battery pack.
- The battery life varies depending on how it is stored and the operating conditions and environment for each battery pack.

---

“InfoLITHIUM” is a trademark of Sony Corporation.

---

# About i.LINK

The DV Interface on this unit is an i.LINK-compliant DV Interface. This section describes the i.LINK standard and its features.

## What is i.LINK?

i.LINK is a digital serial interface for transferring digital video, digital audio, and other data to other i.LINK-compatible device. You can also control other device using the i.LINK.

i.LINK-compatible device can be connected using an i.LINK cable. Possible applications are operations and data transactions with various digital AV devices.

When two or more i.LINK-compatible device are connected to this unit in a daisy chain, operations and data transactions are possible with not only the device that this unit is connected to but also with other devices via the directly connected device.

Note, however, that the method of operation sometimes varies according to the characteristics and specifications of the device to be connected. Also, operations and data transactions may not be possible on some connected device.

### Note

- Normally, only one device can be connected to this unit with the i.LINK cable. When connecting this unit to i.LINK-compatible device having two or more DV Interfaces, refer to the operating instructions of the device to be connected.

### Tips

- i.LINK is a more familiar term for the IEEE 1394 data transport bus proposed by Sony, and is a trademark approved by many corporations.
- IEEE 1394 is an international standard standardized by the Institute of Electrical and Electronics Engineers.

## About i.LINK Baud rate

i.LINK's maximum baud rate varies according to the device. There are three types.

S100 (approx. 100Mbps\*)

S200 (approx. 200Mbps)

S400 (approx. 400Mbps)

The baud rate is listed under “Specifications” in the operating instructions of each piece of

→ *continued*

device. It is also indicated near the i.LINK interface on some device.

The baud rate may differ from the indicated value when the unit is connected to device with a different maximum baud rate.

\* What is Mbps?

Mbps stands for “megabits per second,” or the amount of data that can be sent or received in one second. For example, a baud rate of 100 Mbps means that 100 megabits of data can be sent in one second.

## To use i.LINK functions on this unit

For details on how to dub when this unit is connected to other video device having a DV Interface, see page 60, 61.

This unit can also be connected to other i.LINK (DV Interface) compatible device made by Sony (e.g. a VAIO series personal computer) as well as to video device.

Before connecting this unit to your computer, make sure that application software supported by this unit is already installed on your computer.

Some i.LINK compatible video device such as Digital Televisions, DVD recorders/players, and MICROMV recorders/players are not compatible with DV device. Before connecting to other device, be sure to confirm whether the device is compatible with DV device or not.

For details on precautions and compatible application software, refer also to the operating instructions for the device to be connected.

## About the required i.LINK cable

Use the Sony i.LINK 4-pin-to-4-pin cable (during DV dubbing).

---

i.LINK and  are trademarks of Sony Corporation.

---

# Maintenance and precautions

## On use and care

- Do not use or store the camcorder and accessories in the following locations.
  - Anywhere extremely hot or cold. Never leave them exposed to temperatures above 60°C (140°F), such as under direct sunlight, near heaters or in a car parked in the sun. They may malfunction or become deformed.
  - Near strong magnetic fields or mechanical vibration. The camcorder may malfunction.
  - Near strong radio waves or radiation. The camcorder may not be able to record properly.
  - Near AM receivers and video equipment. Noise may occur.
  - Sandy beach or anywhere dusty. If sand or dust gets in your camcorder, it may malfunction. Sometimes this malfunction cannot be repaired.
  - Near windows or outdoors, where the LCD screen, the viewfinder, or the lens may be exposed to direct sunlight. This damages the inside of the viewfinder or the LCD screen.
  - Anywhere very humid.
- Operate your camcorder on DC 7.2 V (battery pack) or DC 8.4 V (AC Adaptor).
- For DC or AC operation, use the accessories recommended in these operating instructions.
- Do not let your camcorder get wet, for example, from rain or sea water. If your camcorder gets wet, it may malfunction. Sometimes this malfunction cannot be repaired.
- If any solid object or liquid get inside the casing, unplug your camcorder and have it checked by a Sony dealer before operating it any further.
- Avoid rough handling, disassembling, modifying, physical shock, or impact such as hammering, dropping or stepping on the product. Be particularly careful of the lens.
- Keep the POWER switch setting to (CHG) OFF when you are not using your camcorder.

- Do not wrap your camcorder with a towel, for example, and operate it. Doing so might cause heat to build up inside.
- When disconnecting the power cord, pull by the plug and not the cord.
- Do not damage the power cord such as by placing anything heavy on it.
- Keep metal contacts clean.
- If the battery electrolytic liquid has leaked,
  - consult your local authorized Sony service facility.
  - wash off any liquid that may have contacted your skin.
  - if any liquid gets in your eyes, wash with plenty of water and consult a doctor.

### When not using your camcorder for a long time

Occasionally turn it on and let it run such as by playing back tapes for about 3 minutes. Otherwise, unplug it from the wall outlet.

### Moisture condensation

If your camcorder is brought directly from a cold place to a warm place, moisture may condense inside your camcorder, on the surface of the tape, or on the lens. In this state, the tape may stick to the head drum and be damaged or your camcorder may not operate correctly. If there is moisture inside your camcorder, [📺▲ Moisture condensation. Eject the cassette] or [📺 Moisture condensation. Turn off for 1H.] appears. The indicator will not appear when the moisture condenses on the lens.

### If moisture condensation has occurred

None of the functions except cassette ejection will work. Eject the cassette, turn off your camcorder, and leave it for about one hour with the cassette lid open. Your camcorder can be used again if the 📺 or ▲ does not appear when the power is turned on again.

If moisture starts to condense, your camcorder sometimes cannot detect condensation. If this happens, the cassette is sometimes not ejected for 10 seconds after the cassette lid is opened. This is not a malfunction. Do not close the cassette lid until the cassette is ejected.

### Notes on moisture condensation

Moisture may condense when you bring your camcorder from a cold place into a warm place (or vice versa) or when you use your camcorder in a humid place as shown below.

- When you bring your camcorder from a ski slope into a place warmed up by a heating device.
- When you bring your camcorder from an air-conditioned car or room into a hot place outside.
- When you use your camcorder after a squall or a shower.
- When you use your camcorder in a hot and humid place.

### How to prevent moisture condensation

When you bring your camcorder from a cold place into a warm place, put your camcorder in a plastic bag and seal it tightly. Remove the bag when the air temperature inside the plastic bag has reached the surrounding temperature (after about one hour).

### Video head

- When the video head becomes dirty, you cannot record pictures normally, or distorted picture or sound is played back.
- The video head suffers from wear after long use. If you cannot obtain a clear image even after using a cleaning cassette, it might be because the video head is worn. Please contact your Sony dealer or local authorized Sony service facility to have the video head replaced.
- For Hi8 TRV138/338:
  - If the following problem occurs, clean the video heads for 10 seconds with the Sony V8-25CLD cleaning cassette (optional).
    - Playback pictures contains noise or the screen is displayed in blue.
    - Playback pictures are hardly visible.

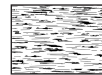

- Playback pictures do not appear.
- [📺] Dirty video head. Use a cleaning cassette.] appears on the screen during recording.

→ continued

- For DTRV280:

If the following problem occurs, clean the video heads for 10 seconds with the Sony V8-25CLD cleaning cassette (optional).

- Mosaic-pattern noise appears on the playback picture or the screen is displayed in blue.



- Playback pictures do not move.
- Playback pictures do not appear or the sound breaks off.
- [🗑️📹] Dirty video head. Use a cleaning cassette. appears on the screen during recording.

## LCD screen

- Do not add excessive pressure on the LCD screen, as it may cause damage.
- If your camcorder is used in a cold place, a residual image may appear on the LCD screen. This is not a malfunction.
- While using your camcorder, the back of the LCD screen may heat up. This is not a malfunction.

## To clean the LCD screen

- If fingerprints or dust make the LCD screen dirty, it is recommended you use a soft cloth to clean it. When you use the LCD Cleaning Kit (optional), do not apply the cleaning liquid directly to the LCD screen. Use cleaning paper moistened with the liquid.

## On handling the casing

- If the casing is soiled, clean the camcorder body with a soft cloth lightly moistened with water, and then wipe the casing with a dry soft cloth.
- Avoid the following to avoid damage to the finish.
  - Using chemicals such as thinner, benzine, alcohol, chemical cloths, repellent and insecticide.
  - Handling with above substances on your hands.
  - Leaving the casing in contact with rubber or vinyl objects for a long period of time.

## About care and storage of the lens

- Wipe the surface of the lens clean with a soft cloth in the following instances:
  - When there are fingerprints on the lens surface.
  - In hot or humid locations
  - When the lens is exposed to salty air such as at the seaside.
- Store in a well-ventilated location subject to little dirt or dust.
- To prevent molds periodically clean the lens as described above.

It is recommended you operate your camcorder about once a month to keep it in an optimum state for a long time.

## To charge the pre-installed rechargeable battery

Your camcorder has a pre-installed rechargeable battery to retain the date, time, and other settings even when the POWER switch is set to (CHG) OFF. The pre-installed rechargeable battery is always charged while you are using your camcorder but it will get discharged gradually if you do not use your camcorder. The rechargeable battery will be fully discharged in about 3 months if you do not use your camcorder at all. However, even if the pre-installed rechargeable battery is not charged, the camcorder operation will not be affected as long as you are not recording the date.

## Procedures

Connect your camcorder to a wall outlet using the supplied AC Adaptor, and leave it with the POWER switch set to (CHG) OFF for more than 24 hours.

# Specification

## Video camera recorder

### System

#### Video recording system

- For **Hi8** TRV138/338:  
2 rotary heads, Helical scanning FM system
- For **TRV280**:  
2 rotary heads, Helical scanning system

#### Audio recording system

- For **Hi8** TRV138/338:  
Rotary heads, FM system
- For **TRV280**:  
Rotary heads, PCM system
- Quantization: 12 bits (Fs 32 kHz, stereo 1, stereo 2), 16 bits (Fs 48 kHz, stereo)

#### Video signal

- NTSC color, EIA standards

#### Usable cassette

- 8 mm video format cassette

#### Tape speed

- For **Hi8** TRV138/338:  
SP: Approx. 14.35 mm/s  
LP: Approx. 7.19 mm/s
- For **TRV280**:  
SP: Approx. 28.67 mm/s  
LP: Approx. 19.11 mm/s

#### Recording/playback time (using 120 min. Hi8/Digital8 video cassette)

- For **Hi8** TRV138/338:  
SP: 2 h  
LP: 4 h
- For **TRV280**:  
SP: 1 h  
LP: 1 h 30 min

#### Fast forward/rewind time (using 120 min. Hi8/Digital8 video cassette)

- Approx. 5 min

#### Viewfinder

- Electric viewfinder (monochrome)

#### Image device

- For **Hi8** TRV138/338:  
3.0 mm (1/6 type) CCD (Charge Coupled Device)
- Gross: Approx. 320 000 pixels
- Effective: Approx. 200 000 pixels

- For **TRV280**:  
3.0 mm (1/6 type) CCD (Charge Coupled Device)

- Gross: Approx. 460 000 pixels
- Effective: Approx. 290 000 pixels

#### Lens

- Combined power zoom lens
- Filter diameter: 37 mm (1 1/2 in.)
- 20 × (Optical), 990 × (Digital)
- F=1.6 - 2.4

#### Focal length

- 2.5 - 50 mm (1/8 - 2 in.)
- When converted to a 35 mm still camera
- 42 - 840 mm (1 11/16 - 33 1/8 in.)

#### Color temperature

- Auto

#### Minimum illumination

- For **Hi8** TRV138/338:  
1 lx (lux) (F 1.6)
- For **TRV280**:  
4 lx (lux) (F 1.6)
- 0 lx (lux) (in the NightShot plus mode)\*<sup>1</sup>
- \*<sup>1</sup>Objects unable to be seen due to the dark can be shot with infrared lighting.

### Input/Output connectors

#### Audio/Video output

- AV MINIJACK
- Video signal: 1 V<sub>p-p</sub>, 75 Ω (ohms), unbalanced, sync negative
- Audio signal: 327 mV (at output impedance more than 47 kΩ (kilohms)), Output impedance with less than 2.2 kΩ (kilohms)
- For **Hi8** TRV138/338:  
Monaural minijack (ø 3.5 mm)
- For **TRV280**:  
Stereo minijack (ø 3.5 mm)

#### DV input/output

- For **TRV280**:  
4-pin connector, S100

#### USB jack

- For **TRV280**:  
mini-B

### LCD screen

#### Picture

- 6.2 cm (2.5 type)

#### Total dot number

- 123 200 (560 × 220)

## General

### Power requirements

- DC 7.2 V (battery pack)
- DC 8.4 V (AC Adaptor)

### Average power consumption (when using the battery pack)

- For **Hi8** TRV138/338:
  - During camera recording using the viewfinder 1.8 W
  - During camera recording using the LCD 2.7 W
- For **F** TRV280:
  - During camera recording using viewfinder 2.5 W
  - During camera recording using LCD 3.4 W

### Operating temperature

- 0° C to 40° C (32° F to 104° F)

### Storage temperature

- 20° C to + 60° C (-4° F to + 140° F)

### Dimensions (approx.)

- 85 × 98 × 151 mm (3 3/8 × 3 7/8 × 6 in.) (w/h/d)

### Mass (Approx.)

- 780 g (1 lb 11 oz) main unit only
- 890 g (1 lb 15 oz) including the NP-FM30 rechargeable battery pack, Hi8/Digital8 cassette, lens cap, and shoulder strap

### Supplied accessories

- See page 11.

## AC Adaptor AC-L15A/L15B

### Power requirements

- AC 100 - 240 V, 50/60 Hz

### Current consumption

- 0.35 - 0.18 A

### Power consumption

- 18 W

### Output voltage

- DC 8.4 V\*<sup>2</sup>

### Operating temperature

- 0° C to 40° C (32° F to 104° F)

### Storage temperature

- 20° C to + 60° C (-4° F to + 140° F)

### Dimensions (approx.)

- 56 × 31 × 100 mm (2 1/4 × 1 1/4 × 4 in.) (w/h/d) excluding the projecting parts

### Mass (approx.)

- 190 g (6.7 oz) excluding the power cord
- \*<sup>2</sup>See the label on the AC Adaptor for other specifications.

## Rechargeable battery pack (NP-FM30)

### Maximum output voltage

- DC 8.4 V

### Output voltage

- DC 7.2 V

### Capacity

- 5.0 Wh (700 mAh)

### Dimensions (approx.)

- 38.2 × 20.5 × 55.6 mm  
(1 9/16 × 13/16 × 2 1/4 in.) (w/h/d)

### Mass (approx.)

- 65 g (2.3 oz)

### Operating temperature

- 0° C to 40° C (32° F to 104° F)

### Type

- Lithium ion

Design and specifications are subject to change without notice.

## Types of differences

Model	video Hi8		Digital 8
	TRV138	CCD- TRV338	DCR- TRV280
Recording system	Hi8	Hi8	Digital8
Playback system	Hi8/8	Hi8/8	Digital8
Audio recording	Monaural	Monaural	Stereo
AUDIO/VIDEO jack	OUT	OUT	OUT
DV Interface	—	—	IN/OUT
USB jack	—	—	●
SteadyShot	—	●	●

● Provided

— Not provided

# Identifying parts and controls

## Camcorder

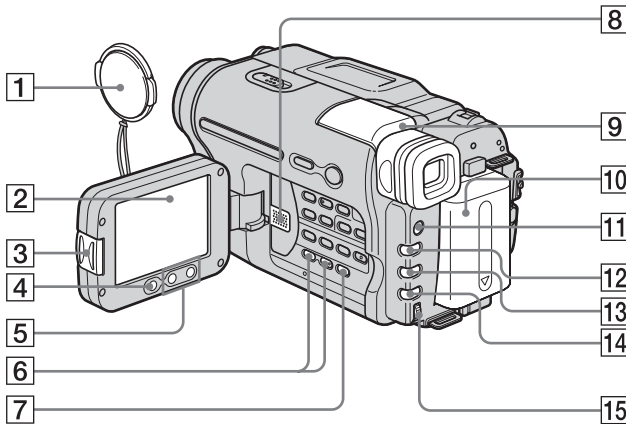

- 1** Lens cap (p. 21, 25)
- 2** LCD screen (p. 3, 16)
- 3** OPEN button (p. 16)
- 4** REC START/STOP button on LCD frame (p. 21)
- 5** Zoom buttons on LCD frame (p. 23)
- 6** VOLUME +/-\* button (p. 34)
- 7** END SEARCH button (p. 33)
- 8** Speaker
- 9** Viewfinder (p. 3, 16)  
If you attach the large capacity battery pack NP-QM71D/QM91D (optional) to the camcorder, extend and lift up the viewfinder and adjust its angle.
- 10** Battery pack
- 11** LIGHT button (p. 23)
- 12** FADER button (p. 30)
- 13** BACK LIGHT button (p. 27)
- 14** FOCUS button (p. 29)
- 15** SEL/PUSH EXEC dial (p. 41)  
\* This button has a tactile dot.

### To attach the lens cap

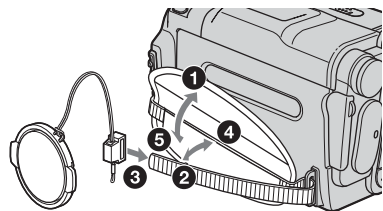



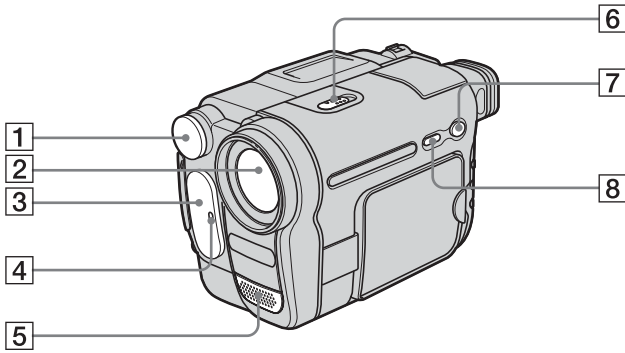

- |                                                                                                                                                                                     |                                                                                                                                                                                            |
|-------------------------------------------------------------------------------------------------------------------------------------------------------------------------------------|--------------------------------------------------------------------------------------------------------------------------------------------------------------------------------------------|
| <ul style="list-style-type: none"> <li>1 Built-in light (p. 23)</li> <li>2 Lens</li> <li>3 Infrared ray emitter (p. 62, 68)</li> <li>4 Camera recording lamp (p. 21, 26)</li> </ul> | <ul style="list-style-type: none"> <li>5 Microphone</li> <li>6 NIGHTSHOT PLUS switch (p. 28)</li> <li>7 EASY button (p. 26, 36)</li> <li>8 DISPLAY/BATT INFO button (p. 13, 37)</li> </ul> |
|-------------------------------------------------------------------------------------------------------------------------------------------------------------------------------------|--------------------------------------------------------------------------------------------------------------------------------------------------------------------------------------------|

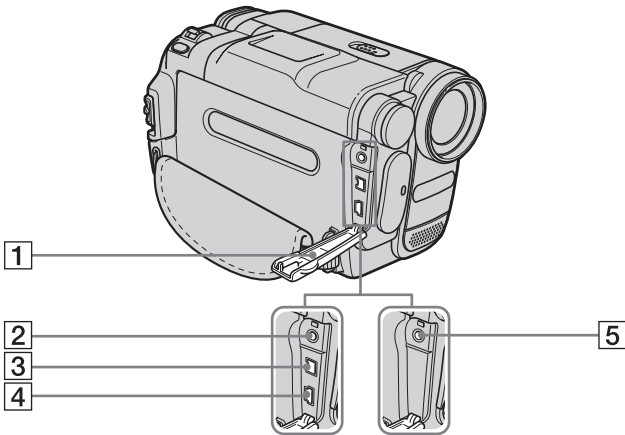

- |                                                                                                                                                                                                                     |                                                                                                      |
|---------------------------------------------------------------------------------------------------------------------------------------------------------------------------------------------------------------------|------------------------------------------------------------------------------------------------------|
| <ul style="list-style-type: none"> <li>1 Jack cover</li> <li>2 For Hi8 TRV280:<br/>A/V OUT jack (p. 39, 60)</li> <li>3 For Hi8 TRV280:<br/>iDV Interface (p. 60)</li> <li>4 For Hi8 TRV280:<br/>USB jack</li> </ul> | <ul style="list-style-type: none"> <li>5 For Hi8 TRV138/338:<br/>A/V OUT jack (p. 39, 59)</li> </ul> |
|---------------------------------------------------------------------------------------------------------------------------------------------------------------------------------------------------------------------|------------------------------------------------------------------------------------------------------|

→ continued

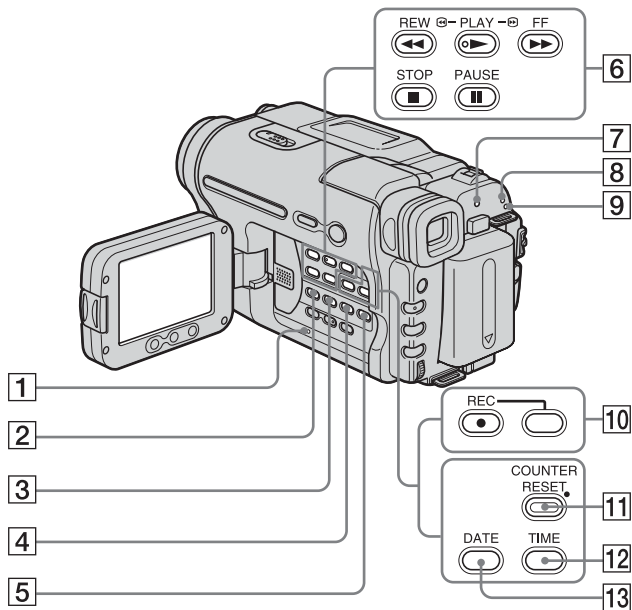

**1** RESET button (p. 82)

**2** For **TRV280**:  
BURN DVD/VCD

You can easily take a picture recorded on the tape and burn it onto a DVD or CD-R. For details on BURN DVD, see “Creating a DVD (Direct Access to “Click to DVD”)” (p. 79), and on BURN VCD, see “First Step Guide” in the supplied CD-ROM.





For **TRV138/338**:  
EASY DUB (Easy Dubbing) button  
(p. 62)

**3** TITLE button (p. 31)

**4** EXPOSURE button (p. 28)

**5** MENU button\* (p. 41)

**6** Video control buttons (p. 34)

-  STOP (stop)
-  REW (rewind)
-  PLAY (playback)\*
-  FF (fast-forward)
-  PAUSE (pause)

**7** CHG (charge) lamp (p. 12)

**8** CAMERA mode lamp (p. 15)

**9** PLAY/EDIT mode lamp (p. 15)

**10** For **TRV280**:  
Rec buttons (p. 66)  
 REC (rec)

**11** For **TRV138/338**:  
COUNTER RESET button (p. 22)

**12** For **TRV138/338**:  
TIME button (p. 18, 25)

**13** For **TRV138/338**:  
DATE button (p. 18, 25)

\* This button has a tactile dot.

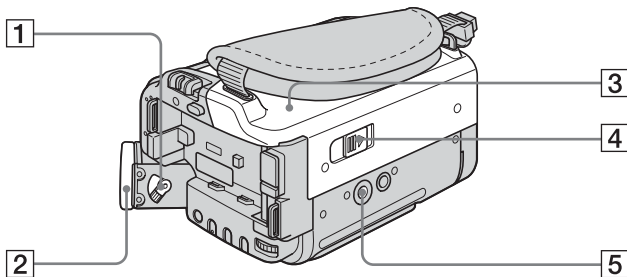

**1** Viewfinder lens adjustment lever (p. 16)

**2** Eyecup

**3** Cassette lid

**4**  OPEN/EJECT lever (p. 18)

**5** Tripod receptacle

Make sure that the length of the tripod screw is less than 5.5 mm (7/32 inch). Otherwise, you cannot attach the tripod securely, and the screw may damage your camcorder.

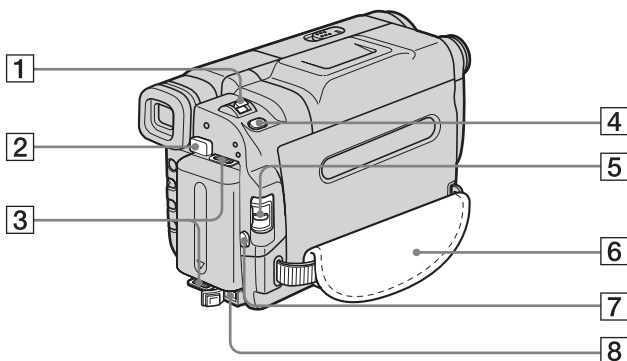

**1** Power zoom lever (p. 23)

**2** BATT (battery) release button (p. 12)

**3** Hooks for shoulder strap

**4** For  TRV280:  
PHOTO button (p. 25)

**5** POWER switch (p. 15)

**6** Grip belt (p. 4)

**7** REC START/STOP button (p. 21)

**8** DC IN jack (p. 12)

### To attach the shoulder strap

Attach the shoulder strap supplied with your camcorder to the hooks for the shoulder strap.

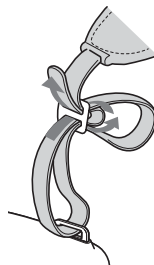

→ continued

## Indicators for the LCD screen and viewfinder

Following indicators will appear on the LCD screen and viewfinder to indicate the state of your camcorder.

Indicators and their on-screen/viewfinder positions vary depending on your camcorder model.

### Example: Indicators in the CAMERA mode

Time code (p. 22)/Tape counter (p. 22)/Self-diagnosis (p. 92)/Tape photo recording (p. 25)

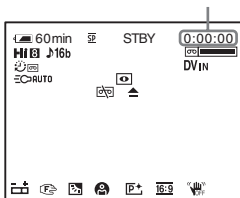

Indicators	Meanings
	Manual exposure (p. 28)
	Manual focus (p. 29)
	Back light (p. 27)
	PROGRAM AE (p. 42)
	Picture effect (p. 43)
	16:9 WIDE/CINEMA/16:9 FULL (p. 46)
	SteadyShot off (p. 48)

Indicators	Meanings
	Remaining battery time (p. 22)
	Recording mode (p. 22)
STBY REC	Recording standby/recording mode
	Mirror mode (p. 24)
	Tape photo recording (p. 25)
<b>H18</b>	Format indicator
<b>16b</b>	Audio mode (p. 52)
	Remaining tape (p. 22)
	Interval recording (p. 54)
	Frame recording (p. 53)
<b>DV IN</b>	DV input (p. 66)
	Built-in light (p. 23)
	NightShot plus (p. 28)
	Warning (p. 92)

# Index

## Numerics

16:9 WIDE mode .....46, 47

## A

A/V connecting cable  
.....39, 59, 60  
AC Adaptor.....15  
Adjusting the viewfinder ...16  
AUDIO MIX.....50  
AUDIO MODE.....52  
AUTO DATE.....55  
AUTO SHTR .....44  
Auto shut off function  
(A.SHUT OFF) .....57

## B

BACK LIGHT .....27  
Battery  
    Battery Info .....13  
    Battery pack .....12  
    Remaining battery time  
        .....22, 96  
BEEP.....57  
BLACK FADER.....30  
Built-in light.....23  
BURN DVD/VCD .....79, 106

## C

Camera settings data display  
.....37  
Cassette .....18, 95  
CD-ROM .....72  
Charging the battery  
    Battery Pack .....12  
    Pre-installed rechargeable  
        battery .....100  
Cleaning cassette.....100  
Clock set  
(CLOCK SET) .....17, 55

## D

Data code  
(DATA CODE) .....37, 57  
Date/time .....37  
DEMO MODE.....56

Digital program editing  
(VIDEO EDIT)..... 67  
Digital zoom (D ZOOM)...45  
Digital8 system.....95  
Direct Access to  
    “Click to DVD” .....79  
DirectX 9.0c .....76  
Display  
    DISPLAY .....58  
    Display indicator.....108  
DNR.....50  
Dual sound track tape .....49  
Dubbing .....59  
DV Interface .....79

## E

Easy Dubbing .....62  
Easy Handycam .....26, 36  
EDIT .....49  
END SEARCH.....33  
Exposure .....27

## F

FADER.....30  
First Step Guide.....73, 74  
Focus .....29  
Frame recording  
(FRAME REC) .....53  
Full charge .....12

## G

Grip belt.....4

## H

Hi8/standard 8 mm system  
.....95  
HiFi SOUND .....49

## I

i.LINK .....97  
i.LINK cable ....60, 67, 72, 79  
ID-1/ID-2 system.....47  
ImageMixer VCD2.....74  
“InfoLITHIUM” battery pack  
.....96  
Infrared ray emitter.....62, 68  
Install .....74  
Interval recording  
(INT. REC) .....54

## L

Language  
(LANGUAGE).....19, 56  
LCD back light  
(LCD B.L.).....51  
LCD brightness  
(LCD BRIGHT) .....16  
LCD COLOR.....51  
LCD screen .....3  
LP (Long Play)  
    See Recording mode  
        (REC MODE)  
LTR SIZE.....55

## M

Macintosh.....73, 77  
Main sound  
    See HiFi SOUND  
Menu .....41  
    CAMERA SET.....45  
    LCD SET.....51  
    MANUAL SET .....42  
    OTHERS .....57  
    PLAYER SET .....49  
    SETUP MENU .....55  
    TAPE SET.....52  
    VCR SET.....49  
Mirror mode .....24  
Moisture condensation .....99  
Monaural .....21, 40  
MONOTONE FADER.....31  
MOSAIC FADER .....30

## N

NightShot Light  
(N.S. LIGHT) .....29, 48  
NightShot plus .....28  
NTSC .....94

## O

On-line help .....77, 78  
Operation confirmation beep  
    See BEEP  
ORC .....52

→continued

## P

PAL ..... 94  
Picture effect  
    (P EFFECT)..... 43  
Picture Package ..... 74  
Picture search ..... 35  
Playing time ..... 14  
Power mode..... 15  
PROGRAM AE..... 42

## R

Recording capacity  
    Display ..... 22  
    REMAIN ..... 53  
Recording lamp  
    (REC LAMP)..... 58  
Recording mode  
    (REC MODE) ..... 22, 52  
Recording time ..... 14  
RESET..... 106

## S

Self-diagnosis display ..... 92  
Setting the date and time ... 17  
Skip scan ..... 35  
SP (Standard Play)  
    See Recording mode  
    (REC MODE)  
STEADYSHOT..... 48  
Stereo..... 21, 40  
STRIPE FADER ..... 31  
Sub sound  
    See HiFi SOUND

## T

Tape counter..... 22  
Tape photo recording ..... 25  
TBC ..... 50  
Telephoto  
    See Zoom  
Time code..... 22  
Title ..... 31  
TV color systems..... 94

## U

USB cable .....72  
USB jack..... 105  
USB Streaming  
    (USB STREAM).....55  
Using abroad .....94

## V

Video head .....99  
Viewfinder .....16  
Volume .....34

## W

Warning indicators.....92  
Warning messages .....93  
WHITE FADER .....30  
Wide angle  
    See Zoom  
Windows ..... 73, 74  
WORLD TIME.....57  
Write-protect tab .....95

## Z

Zoom.....23



<http://www.sony.net/>



Printed on 100% recycled paper using  
VOC (Volatile Organic Compound)-free  
vegetable oil based ink.

Printed in Japan



2515259120