

OLYMPUS®

CAMEDIA

DIGITAL CAMERA

D-540ZOOM

C-310ZOOM

X-100

REFERENCE MANUAL

<Click Here>

CAMERA OPERATION MANUAL

Explanation of digital camera functions and operating instructions.

**DIGITAL CAMERA - PC CONNECTION
OPERATION MANUAL**

Explanation of how to download images between your digital camera and PC.

OLYMPUS®

CAMEDIA
DIGITAL CAMERA

D-540ZOOM
C-310ZOOM
X-100

REFERENCE MANUAL

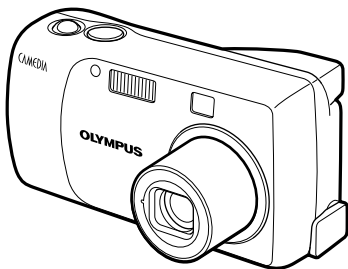

-
- Thank you for purchasing an Olympus digital camera. Before you start to use your new camera, please read these instructions carefully to enjoy optimum performance and a longer service life. Keep this manual in a safe place for future reference.
 - We recommend that you take test shots to get accustomed to your camera before taking important photographs.
 - Screen and camera illustrations shown in this manual may differ from those of the actual product.

For customers in North and South America

For customers in USA

Declaration of Conformity

Model Number : D-540ZOOM/C-310ZOOM/X-100

Trade Name : OLYMPUS

Responsible Party : Olympus America Inc.

Address : 2 Corporate Center Drive, Melville, New York
11747-3157 U.S.A.

Telephone Number : 1-631-844-5000

Tested To Comply With FCC Standards
FOR HOME OR OFFICE USE

This device complies with Part 15 of the FCC rules. Operation is subject to the following two conditions:

- (1) This device may not cause harmful interference.
- (2) This device must accept any interference received, including interference that may cause undesired operation.

For customers in Canada

This Class B digital apparatus meets all requirements of the Canadian Interference-Causing Equipment Regulations.

For customers in Europe



“CE” mark indicates that this product complies with the European requirements for safety, health, environment and customer protection. “CE” mark cameras are intended for sales in Europe.

Trademarks

- IBM is a registered trademark of International Business Machines Corporation.
- Microsoft and Windows are registered trademarks of Microsoft Corporation.
- Macintosh is a trademark of Apple Computer Inc.
- All other company and product names are registered trademarks and/or trademarks of their respective owners.
- The standards for camera file systems referred to in this manual are the “Design Rule for Camera File System/DCF” standards stipulated by the Japan Electronics and Information Technology Industries Association (JEITA).



Composition of the manual

| | | | |
|---|-------------------------------------|-------|----------|
| | Contents | P.4 | |
| Introduction of the camera's functions. | Getting started | P.8 | 1 |
| | About the menus | P.31 | 2 |
| For shooting and learning the basic operations. | Shooting basics | P.40 | 3 |
| For fine-tuning the settings to get that particular shot. | Advanced shooting | P.59 | 4 |
| For playing back and arranging pictures. | Playback | P.73 | 5 |
| Settings that make the camera easier to operate. | Useful functions | P.89 | 6 |
| Printing pictures. | Print setting (DPOF) | P.98 | 7 |
| | Direct printing (PictBridge) | P.107 | 8 |
| Troubleshooting and other information. | Miscellaneous | P.121 | 9 |
| | Specifications | P.135 | |
| | Glossary of terms | P.137 | |
| | Index | P.139 | |

Contents

| | |
|-------------------------------------|---|
| Composition of the manual | 3 |
|-------------------------------------|---|



1 Getting started 8

| | |
|---|----|
| Names of parts | 8 |
| Camera | 8 |
| Monitor indications | 10 |
| How to use this manual | 13 |
| Attaching the strap | 14 |
| Loading the batteries | 15 |
| Selecting optional batteries or an AC adapter | 17 |
| Inserting a card | 19 |
| Card basics | 19 |
| Removing the card | 21 |
| Power on/off | 22 |
| If the card is not recognized (card check) | 24 |
| Selecting a language  | 25 |
| Setting the date and time  | 27 |
| Holding the camera | 30 |







2 About the menus 31

| | |
|--------------------------------|----|
| Types of menus | 31 |
| How to use the menus | 32 |
| Shortcut menus | 34 |
| Shooting mode | 34 |
| Playback mode | 35 |
| Mode Menu | 36 |
| Shooting mode | 36 |
| Playback mode | 38 |









3 Shooting basics 40

| | |
|--|----|
| Shooting mode | 40 |
| Taking still pictures | 44 |
| Comparison of the viewfinder & monitor | 46 |
| Turning off the monitor | 47 |
| If correct focus cannot be obtained | 48 |
| Determine the position of the subject after focusing (Focus Lock) | 48 |
| Subjects that are difficult to focus on | 50 |
| Recording movies  | 51 |
| Zoom | 53 |
| Using the optical zoom | 53 |
| Using the digital zoom | 54 |
| Using the flash  | 56 |



4 Advanced shooting 59

| | |
|---|----|
| Macro mode shooting  | 59 |
| Super macro mode shooting  | 61 |
| Self-timer shooting  | 62 |
| Sequential shooting  | 63 |
| PANORAMA | 64 |
| Selecting a record mode  | 66 |
| Varying the image brightness (Exposure compensation)  | 69 |
| Adjusting the white balance WB | 71 |





5 Playback 73

| | |
|---|----|
| Viewing still pictures  | 73 |
| QUICK VIEW | 74 |
| Close-up playback  | 75 |
| Picture rotation  | 76 |
| Index display  | 77 |
| Selecting the number of pictures | 78 |
| Slideshow  | 79 |
| MOVIE PLAYBACK - Viewing movies  | 80 |
| Protecting pictures  | 82 |
| Erasing pictures  | 83 |
| Single-frame erase | 83 |
| All-frame erase | 84 |
| Editing still pictures (Resizing)  | 85 |
| Editing movies (INDEX-Creating an index) | 87 |

6 Useful functions 89

| | |
|--|----|
| ALL RESET - Saving the camera's settings | 89 |
| CARD SETUP - Formatting cards  | 91 |
| Displaying shooting information INFO | 93 |
| Adjusting the monitor brightness  | 94 |
| REC VIEW | 95 |
| FILE NAME | 96 |
| PIXEL MAPPING | 97 |

7 Print setting (DPOF) 98

| | |
|--|-----|
| With print reservation  | 98 |
| All-frame reservation  | 100 |
| Single-frame reservation  | 102 |
| Resetting print reservation data  | 105 |

8 Direct printing (PictBridge) 107

| | |
|--|-----|
| Using the direct printing function | 107 |
| Connecting the camera to a printer | 108 |
| Printing pictures. | 109 |
| Using the simple print method. | 110 |
| PRINT mode/MULTI PRINT mode | 111 |
| ALL PRINT mode | 115 |
| ALL INDEX mode/PRINT ORDER mode | 117 |
| Exiting direct printing | 119 |
| If an error code is displayed | 120 |

9 Miscellaneous 121

| | |
|--|-----|
| Error codes | 121 |
| Troubleshooting. | 122 |
| The camera does not work | 122 |
| The image quality is poor | 125 |
| Miscellaneous | 127 |
| List of menus | 128 |
| List of factory default settings | 132 |
| List of items by shooting mode | 133 |
| Camera maintenance | 134 |
| Specifications | 135 |
| Glossary of terms | 137 |
| Index | 139 |

1 Getting started

Names of parts



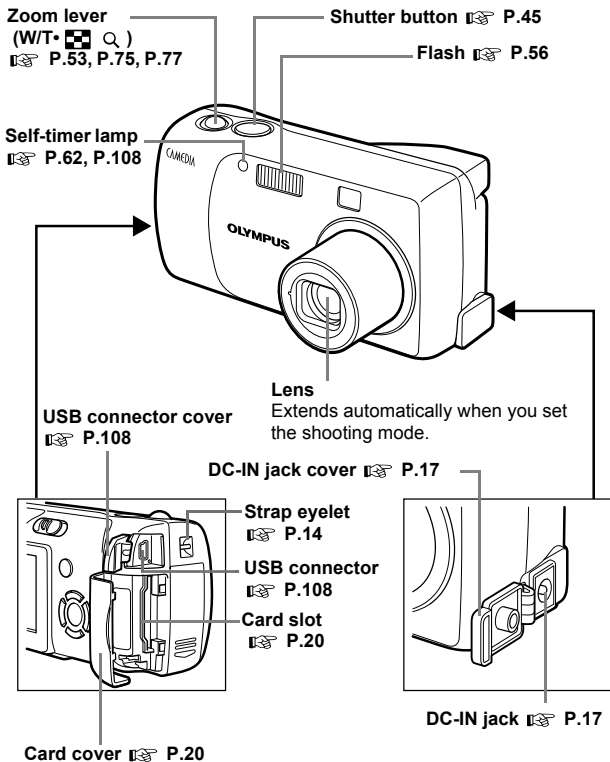

Camera

1

Getting started



Arrow pad

Buttons on the arrow pad have their respective functions. They are also used as direction buttons. , ,  and  indicate which button to be pressed.

Shooting mode button

( : Virtual Dial)

 P.40

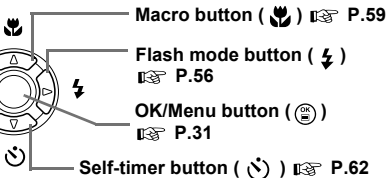



**Viewfinder**

 P.44

Monitor

 P.10

Arrow pad

(, , , )
 P.25, P.31

Power switch

 P.22, P.40, P.73

QUICK VIEW button

 P.74

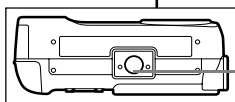
**Battery compartment cover**

 P.15

Tripod socket**Power switch**

OFF 

Playback mode  P.73

Shooting mode  P.40

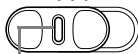

Lock button  P.22, P.40

Monitor indications

● Shooting mode

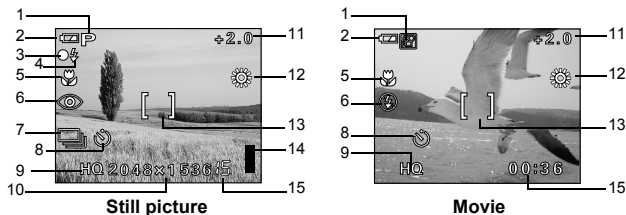

| | Items | Indications | Ref. Page |
|----|---|--|--------------|
| 1 | Shooting mode | , , , , , , , | P.40 |
| 2 | Battery check | , | P.12 |
| 3 | Green lamp | | P.44 |
| 4 | Flash standby Camera movement warning/ Flash charge | (lit) (Blinks) | P.44 |
| 5 | Macro mode | , | P.59 |
| 6 | Flash mode | , , | P.56 |
| 7 | Sequential shooting | , | P.63 |
| 8 | Self-timer | | P.62 |
| 9 | Record mode | SHQ, HQ, SQ1, SQ2 | P.66 |
| 10 | Resolution | 2048×1536, 1600×1200, 640×480, etc. | P.66 |
| 11 | Exposure compensation | -2.0, -1.5, -1.0, -0.5, +0.5, +1.0, +1.5, +2.0 | P.69 |
| 12 | White balance | , , , | P.71 |
| 13 | AF target mark | [] | P.44 |
| 14 | Memory gauge | | P.12 |
| 15 | Number of storable still pictures Remaining recording time | 15 00:36 | P.44 P.51 |

● Playback mode

INFO setting allows you to select how much information to display on the monitor. Screens when the information display is set to ON are shown below.

☞ "Displaying shooting information" (P.93)

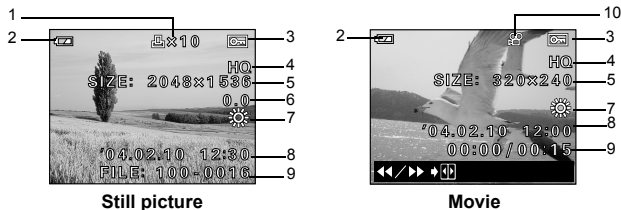

1

Getting started

| | Items | Indications | Ref. Page |
|----|--|--|-----------|
| 1 | Print reservation, Number of prints | x 10 | P.100 |
| 2 | Battery check | | P.12 |
| 3 | Protect | | P.82 |
| 4 | Record mode | SHQ, HQ, SQ1, SQ2 | P.66 |
| 5 | Resolution | 2048x1536, 1600x1200, 640x480, etc. | P.66 |
| 6 | Exposure compensation | -2.0, -1.5, -1.0, -0.5, +0.5, +1.0, +1.5, +2.0 | P.69 |
| 7 | White balance | WB AUTO, , , , | P.71 |
| 8 | Date and time | 04.02.10 12:30 | P.27 |
| 9 | File number (still picture), Number of frames Elapsed time/Total recording time (movie) | 100-0016, 16 00:00/00:15 | - |
| 10 | Movie | | P.80 |



Note

- The indications that appear on a movie picture that has been selected and displayed from the index display are different from those that appear when the movie picture is displayed using the movie playback function.

● Memory gauge

The memory gauge lights up when you take a still picture. While the gauge is lit, the camera is storing the picture on the card. The memory gauge indication changes as shown below depending on the shooting status.

The indication is not displayed during movie recording.

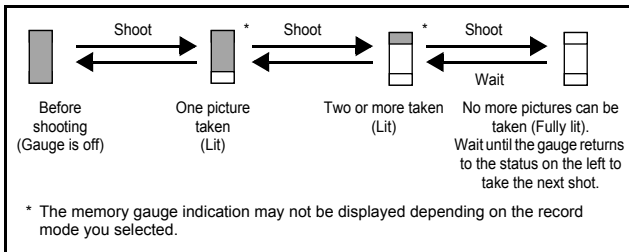

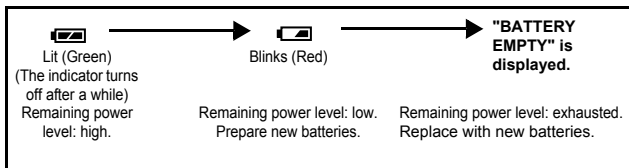

● Battery check

If the remaining battery power is low, the battery check indication on the monitor changes as follows while the camera is turned on.







How to use this manual

Follow the arrows to perform menu operations. For details on operating procedures, see  "How to use the menus" (P.32).

Varying the image brightness (Exposure compensation) 





This function allows you to make fine changes to the automatic exposure setting. In some situations, you may get better results when the exposure that the camera sets is compensated (adjusted) manually. You can adjust the brightness in the range of ± 2.0 in 0.5 steps. When the setting is changed, you can check the result on the monitor.

1 In the shooting mode top menu, select **MODE MENU** → **CAMERA** → , and press .  "How to use the menus" (P.32)

2 Press  to select the exposure compensation value.
• Select a **[+]** value to brighten the image or a **[-]** value to darken the image.

4  **READY**

The buttons for various functions and their location are clearly illustrated.

   and  indicate which button to press on the arrow pad. (The up or down buttons are used in this example.)

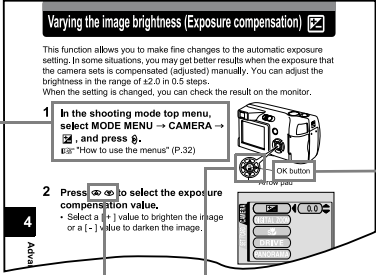

1

Getting started

This sample page is only for your reference. It may differ from the actual page in this manual.

Indications used in this manual



Note

Important information on factors which may lead to malfunctions or operational problems. Also warns of operations that should be absolutely avoided.



Useful information and hints that will help you get the most out of your camera.



Reference pages describing details or associated information.

Attaching the strap

1

Getting started

- 1 Thread the short end of the strap through the strap eyelet.
- 2 Thread the long end of the strap through the loop that has already gone through the eyelet.

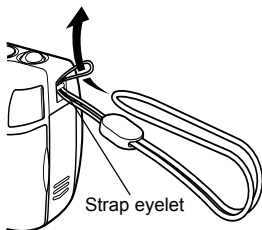

- 3 Pull the strap tight, making sure that it is securely fastened and does not come loose.

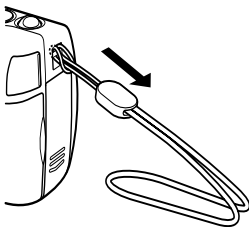

Note

- Be careful with the strap when you carry the camera, as it can easily catch on stray objects, causing serious damage.
- Attach the strap correctly following the procedure so that the camera does not fall off. If the strap is attached incorrectly and the camera falls off, Olympus is not responsible for any damages.

Loading the batteries

This camera uses 1 CR-V3 lithium battery pack, 2 AA (R6) alkaline batteries or NiMH batteries.

Important

- CR-V3 lithium battery cannot be recharged.
- Do not peel off the label from a CR-V3 lithium battery pack.
- Manganese (zinc-carbon) batteries cannot be used.

1 Make sure that the power switch is located at OFF.

Power switch

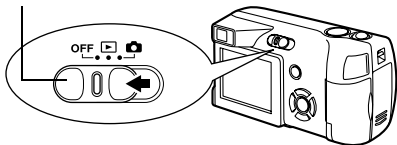

2 Slide the battery compartment cover in the direction of (A).

- The battery compartment cover is unlocked and opened in the direction of (B).
- Use the ball of your finger to slide the cover. Do not use your fingernail as this could result in injury.

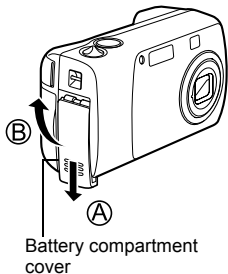

1

Getting started

3 Insert the batteries, making sure that they are correctly oriented as shown in the illustration.

The battery insertion direction mark is provided inside of the battery compartment.

When using AA (R6) batteries

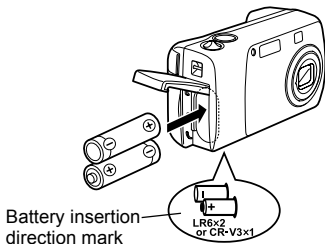

Battery insertion direction mark

There is a mark showing the correct way to insert the AA batteries on the bottom of the camera.

When using a CR-V3 lithium battery pack

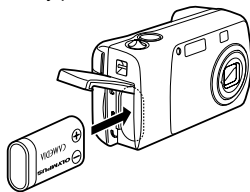

When using a CR-V3 lithium battery pack, insert it in the direction as shown in the illustration.

4 Close the battery compartment cover, and press it down **C** and slide it in the direction shown **D**.

- If the battery compartment cover seems hard to close, do not force it. With the battery compartment cover shut, press the  mark firmly and push it in the direction indicated by **D**.

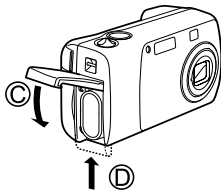

Note

- If the camera is left for about 3 days with the batteries removed, the date and time setting will revert to the factory default setting.

Precautions when using batteries

The amount of power consumed varies considerably depending on the operations performed on the digital camera. If you use exhausted batteries or alkaline batteries, the camera may turn off without displaying the battery level warning (P.12).

Selecting optional batteries or an AC adapter

In addition to the batteries provided with the camera, the following types of battery or AC adapter can be used. Choose the power source best suited to the situation.

● CR-V3 lithium battery pack (Not rechargeable)

Since the CR-V3 lithium battery pack has a long service life, it is convenient when traveling.

● NiMH batteries (Rechargeable batteries)

Olympus NiMH batteries are rechargeable and economical. However, charging the batteries repeatedly before using up their capacity will shorten the life of the batteries per charge gradually.

● AA (R6) alkaline batteries

When you need batteries in a hurry, you can use AA (R6) alkaline batteries, which are easy to obtain anywhere. However, the number of pictures that you can take may vary considerably depending on the battery manufacturer, shooting conditions, etc. Turn off the monitor whenever possible to save power.

● AC adapter

An optional Olympus CAMEDIA-brand AC adapter allows you to power your digital camera from a common AC wall outlet. Be sure to use the specified AC adapter. An AC adapter is useful for time-consuming tasks such as downloading or printing out of images.

Use an AC adapter designed to operate on the AC voltage in the area the camera is being used.

Consult your nearest Olympus dealer or Service center for details.

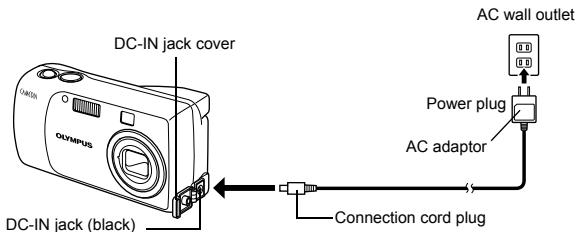



Note

- Manganese (zinc-carbon) batteries cannot be used.
- If the battery power runs out while the camera is connected to a PC or printer, the image data may be lost or damaged. You are recommended to use the AC adapter when transferring images to a PC. Do not connect or disconnect the AC adapter while the camera is communicating with the PC or printer.
- Do not remove or load the batteries or connect or disconnect the AC adapter while the camera is turned on. Doing so could affect the camera's internal settings or functions.
- The life of battery packs may vary according to the type of battery, manufacturer, shooting conditions, etc.
- Power is consumed continuously during the conditions below. This could shorten the life of the batteries.
 - When the monitor is in the playback mode for an extended period of time.
 - Repeated zoom adjustments.
 - Repeated auto-focus by depressing the shutter button halfway.
 - When the camera is connected to a PC or printer.
- Carefully read the AC adapter's instructions before use.
- When using an AC adapter, the AC adapter supplies power to the camera even if batteries are loaded in the camera. The AC adapter does not charge batteries in the camera.

Inserting a card

"Card" in this manual refers to the xD-Picture Card. The camera uses the card to record pictures.

Card basics

The card corresponds to normal camera film for recording the pictures you have taken.

Pictures recorded and stored on the card can easily be erased, overwritten, and/or edited on a PC.

1 Index area

You can write down the card's contents.

2 Contact area

Comes into contact with the camera's signal read contacts.

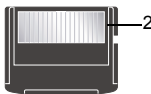

Compatible cards

- xD-Picture Card (16 to 512 MB)



Note

- This camera may not recognize a non-Olympus card or a card that was formatted on another device (such as a PC, etc.). Before use, be sure to format the card on this camera.  "CARD SETUP - Formatting cards" (P.91)

1

Getting started

- 1 Make sure that the power switch is located at OFF.

Power switch

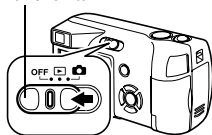

- 2 Open the card cover.

Card cover

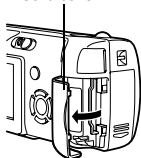

- 3 Face the card the correct way and insert it into the card slot as shown in the illustration.

- Insert the card while keeping it straight.
- The card stops with a click when it is inserted all the way.
- Inserting the card the wrong way or at an angle could damage the contact area or cause the card to jam.
- If the card is not inserted all the way, data may not be written to the card.

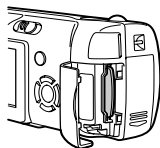
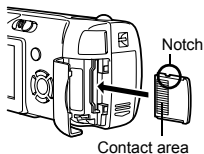

The position of the card inserted correctly

- 4 Close the card cover securely.

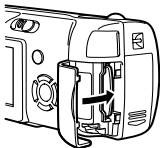

Removing the card

1 Make sure that the power switch is located at OFF.

2 Open the card cover.

3 Push the card all the way in to unlock it, and let it return slowly.

- The card is ejected a short way and then stops.

Note

Releasing your finger quickly after pushing the card all the way in may cause it to eject forcefully out of the slot.

4 Hold the card straight and pull it out.

Power switch

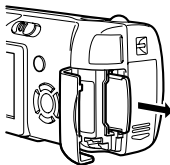
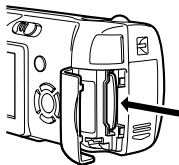
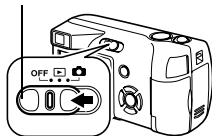

1

Getting started



Note

- Do not press on the card with hard or pointed items such as ballpoint pens.
- Never open the card cover, or remove the card or the batteries while the camera is turned on. Doing so could destroy the data on the card. Once destroyed, data cannot be restored.
- Do not place a sticker or label on the card as this could prevent the card from being ejected.

Power on/off

● When shooting pictures (Shooting mode)

Power on: Slide the power switch to , pressing and holding the lock button.

The camera turns on in the shooting mode. The lens extends and the subject is displayed on the monitor.

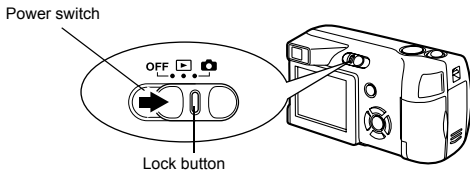

Power off: Slide the power switch to OFF.

The camera turns off. (The monitor also turns off.)

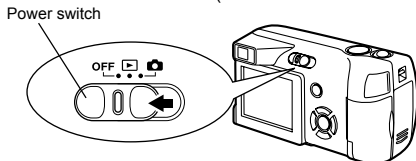

- Even if the monitor is turned off, the battery power is consumed unless the power switch is located at OFF.



TIPS

- To save battery power, the camera automatically enters the sleep mode and stops operating if not used for 3 minutes. If the monitor is on, it will automatically turn off. The camera activates again as soon as you lightly press the shutter button or zoom lever. Whenever possible, turn the camera off when you do not intend to take any pictures for a while.

● When playing back pictures (Playback mode)

- Power on:** Slide the power switch to  .
The camera turns on in the playback mode. The monitor turns on and the last picture taken is displayed.
If no pictures have been taken yet, or the xD-Picture card is empty, the message "NO PICTURE" is displayed on the monitor.

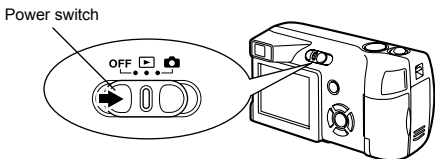

- Power off:** Slide the power switch to OFF.
The monitor and the camera turn off.

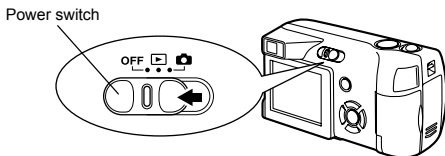

- Even if the monitor is turned off, the battery power is consumed unless the power switch is located at OFF.



TIPS

- When the camera turns on, the monitor may light up momentarily and a picture may be displayed briefly. This is not a malfunction.



Note

- Never open the card cover, remove the card or the batteries, or connect or disconnect the AC adapter while the camera is turned on. Doing so could destroy all data on the card. Destroyed data cannot be restored. When changing the card, be sure to turn the camera off before opening the card cover.







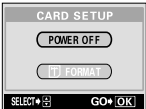

If the card is not recognized (card check)

When the power is turned on, the camera checks the card automatically. If there is no card in the camera or a card that is not supported by this camera is inserted, one of the following screens will be displayed.



- All data stored on the card is erased when the card is formatted.

Note

| Monitor indication | Corrective action |
|--|--|
|  NO CARD | There is no card in the camera or the card is not inserted properly. → Insert a card. If a card is already inserted, remove it and insert it again correctly. |
|  | The card cannot record, play back or erase pictures. Replace with a new card, or format the card. → Press   to select POWER OFF, and press  . Replace it with a new one. → Format the card. Press   to select  FORMAT, and press  to display the confirmation screen. Select YES and press  . Formatting starts. If the card was successfully formatted, the camera is ready to take pictures. |

Selecting a language



You can select a language for on-screen display. This reference manual shows the English on-screen display in the illustrations and explanations. Available languages vary depending on the area where you purchased this camera.

1 Slide the power switch to , pressing and holding the lock button.

- The camera turns on in the shooting mode.
- The lens extends and the monitor turns on.

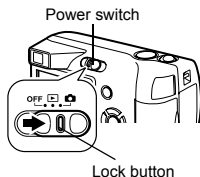

2 Press .

- The top menu is displayed.

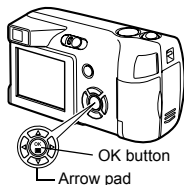

3 Press on the arrow pad to select MODE MENU.

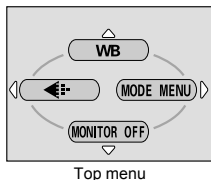

4 Press to select the SETUP tab, and press .

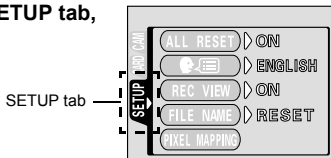

1

Getting started

5 Press to select , and press .

- The green frame moves to the selected item.

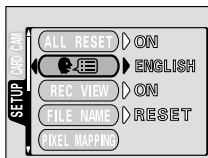

6 Press to select a language, and press .

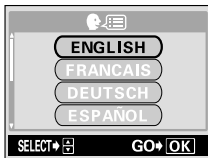

7 Press again to exit the menu.

8 Slide the power switch to OFF.

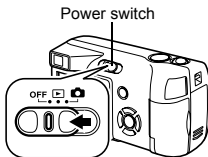

TIPS

- The language can also be set from the playback mode.

Setting the date and time



- 1** Slide the power switch to , pressing and holding the lock button.
- The camera turns on in the shooting mode.
 - The lens extends and the monitor turns on.

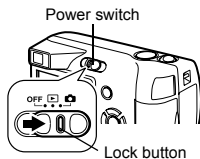

- 2** Press .
- The top menu is displayed.

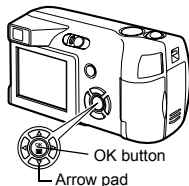

- 3** Press on the arrow pad to select **MODE MENU**.

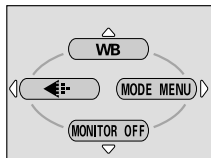

Top menu

- 4** Press to select the **SETUP** tab, and press .

SETUP tab

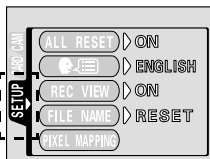

- 5** Press to select , and press .
- The green frame moves to the selected item.

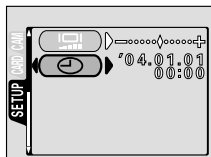

1

Getting started

6 Press to select one of the following date formats: Y-M-D (Year/Month/Day), M-D-Y (Month/Day/Year), D-M-Y (Day/Month/Year). Then press .

- Move to the year setting.
- The following steps show the procedure used when the date and time settings are set to Y-M-D.

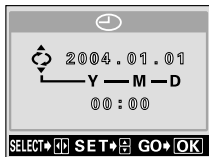

7 Press to set the year, and press to move to the month setting.

- To move back to the previous setting, press .
- The first two digits of the year are fixed.

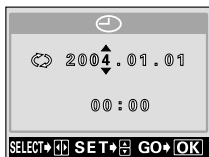

8 Repeat this procedure until the date and time are completely set.

- The camera only displays the time in 24-hour time system ("2. p.m." would be "14:00").

9 Press .

- For a more accurate setting, press when the time signal hits 00 seconds. The clock starts when you press the button.

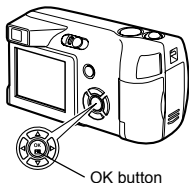

10 Slide the power switch to OFF.

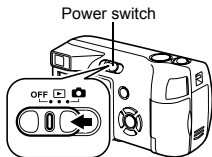



Note

- The current settings are retained even when the power is turned off, unless they are readjusted.
- The date and time settings will be returned to the factory default settings if the camera is left without the battery for approximately 3 days. The settings will be canceled more quickly if the batteries were only loaded in the camera for a short time before being removed. Before taking important pictures, check that the date and time settings are correct.



TIPS

- The date and time can also be set from the playback mode.

Holding the camera

Hold the camera firmly with both hands while keeping your elbows at your sides to prevent the camera from moving.

When taking pictures in vertical position, hold the camera to position the flash above the lens.

Keep your fingers and the strap away from the lens and flash.

Correct grip:

Horizontal grip

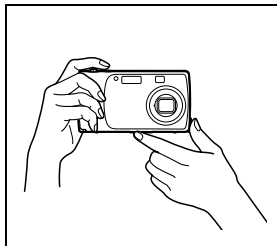

Vertical grip

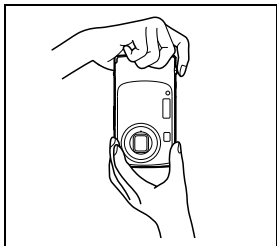

Incorrect grip:

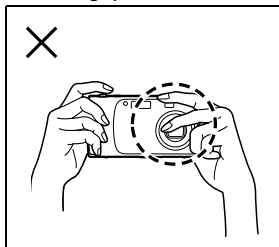

Note

- Clear pictures cannot be obtained if the camera moves as the shutter button is pressed. Hold the camera correctly, and press the shutter button gently.

2 About the menus

Types of menus

When you turn on the camera and press , the top menu is displayed on the monitor. The functions of this camera are set from the menus. This chapter explains how the menus work, using the shooting mode screens.

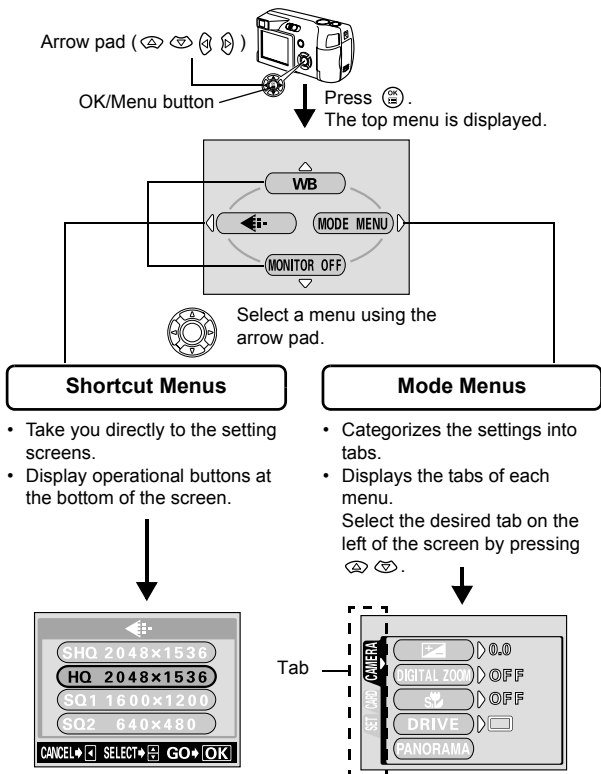

How to use the menus

- 1 Press to display the top menu. Press .

- 2 Press to select a tab, and press .

Top menu

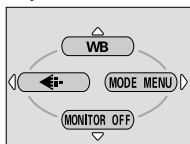

CAMERA tab

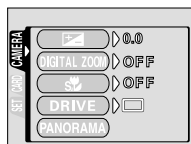

CARD tab

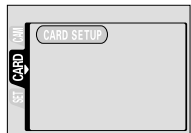

SETUP tab

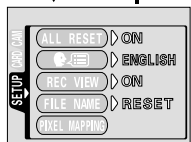

Press to return to the tab selection screen.

2

About the menus

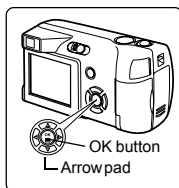

- 3** Press to select an item, and press .

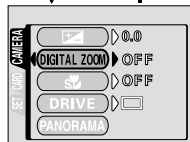
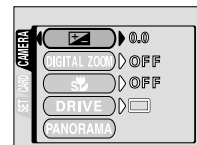

The green frame moves to the selected item.

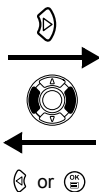

To return to select an item, press or .

- 4** Press to select a setting. Press to complete setting. Press again to exit the menu and return to shooting status.

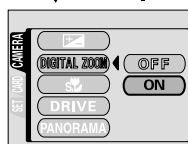
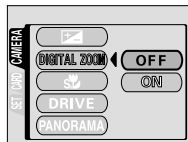

Note

- Not all items can be selected depending on the status of the camera and the settings performed.
- In the shooting mode, you can take pictures by pressing the shutter button even with the menu being displayed.
- If you want to save the settings after the camera is turned off, set ALL RESET to OFF. "ALL RESET - Saving the camera's settings" (P.89)

Shortcut menus

Shooting mode

Shortcut menus are frequently used menus that can be accessed from the top menu.

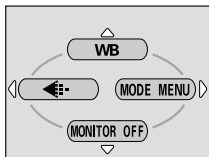

2

About the menus

WB

Sets the appropriate white balance according to the light source.

P.71



Sets the image quality and resolution.

Still picture : SHQ, HQ, SQ1, SQ2

Movie : HQ, SQ

P.66

MONITOR OFF (MONITOR ON)

Sets whether or not the monitor also goes on when the camera turns on. If the monitor is set to off, the top menu displays MONITOR ON when the camera turns on.

P.47

Playback mode

Still picture



Movie



Runs through all saved pictures one after another. It is displayed when the camera is playing back still pictures.

P.79

MOVIE PLAYBACK

Plays back movies. It is displayed when a movie is selected.

P.80

INFO

Displays all the shooting information on the monitor.

P.93



ERASE

Erases the selected still picture or movie.

P.83

Mode Menu



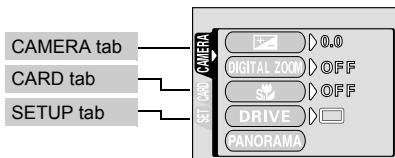

The MODE MENU has 3 tabs. Press   to select a tab and display the associated menu items.

Shooting mode







2

About the menus

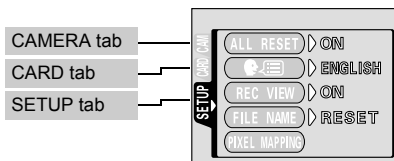
| CAMERA tab | | |
|---|---|------|
|  | Adjusts the brightness of the image (Exposure compensation). | P.69 |
| DIGITAL ZOOM | Enables the zoom shooting at larger magnification than the maximum optical zoom. | P.54 |
|  | Allows pictures to be taken as close as 2 cm/0.8" from the subject. | P.61 |
| DRIVE | Selects the shooting mode from  (Single-frame shooting) and  (Sequential shooting). | P.63 |
| PANORAMA | Allows panorama pictures to be taken with Olympus CAMEDIA-brand cards. | P.64 |

| CARD tab | | |
|------------|-----------------|------|
| CARD SETUP | Formats a card. | P.91 |



| SETUP tab | | |
|---|--|------|
| ALL RESET | Selects whether to keep the current camera settings when you turn off the power. | P.89 |
|  | Selects a language for on-screen display. | P.25 |
| REC VIEW | Selects whether to display pictures on the monitor while saving them to a card. | P.95 |
| FILE NAME | Changes how file names are assigned. | P.96 |
| PIXEL MAPPING | Checks the CCD and image processing functions for errors. | P.97 |
|  | Adjusts the brightness of the monitor. | P.94 |
|  | Sets the date and time. | P.27 |

2

About the menus

Playback mode

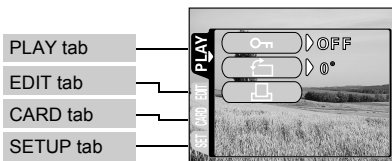

2





About the menus

| PLAY tab | | |
|----------|--|------|
| | Protects pictures from accidental erasure. | P.82 |
| | Rotates pictures 90 degrees clockwise or counterclockwise. | P.76 |
| | Stores print reservation information on the card. | P.98 |

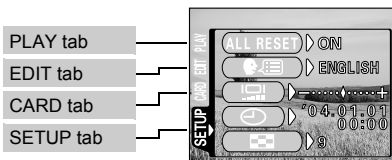
| EDIT tab | | |
|----------|---|------|
| | Makes the file size smaller and saves it as a new file. | P.85 |
| INDEX | Creates an index picture of a movie in 9 frames. | P.87 |

| CARD tab | | |
|------------|---|--------------|
| CARD SETUP | Erases all image data stored on the card. (ALL ERASE, FORMAT) | P.84 P.91 |



| SETUP tab | | |
|---|--|------|
| ALL RESET | Selects whether to keep the current camera settings when you turn off the power. | P.89 |
|  | Selects a language for on-screen display. | P.25 |
|  | Adjusts the brightness of the monitor. | P.94 |
|  | Sets the date and time. | P.27 |
|  | Selects the number of frames in the index display. | P.77 |

2

About the menus

3 Shooting basics

Shooting mode

This camera allows you to take still pictures and record movies. This camera has 7 shooting modes to choose from depending on the shooting conditions and the effect you want to achieve.

The factory default setting of the shooting mode is PROGRAM AUTO. For normal shooting which does not require any special setting or effect, you do not need to follow this procedure.

1 Slide the power switch to , pressing and holding the lock button.

- The camera turns on in the shooting mode.
- The lens extends and the monitor turns on.

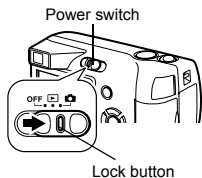

2 Press ().

- The screen for selecting the shooting mode (virtual dial) is displayed.

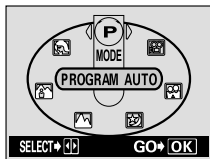
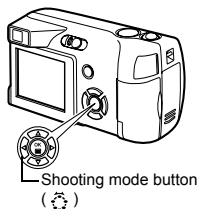

3 Select the mode best suited to your purpose from the following.

- Press to select the mode.

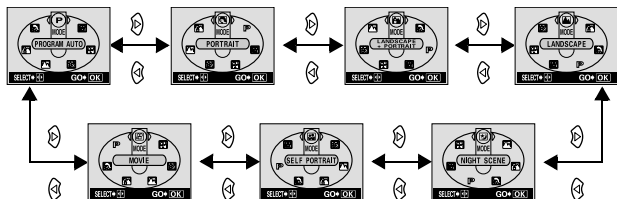

4 Press .

- The shooting mode is set, and the virtual dial screen disappears. Even if the button is not pressed, the mode will be set and the screen will disappear.

● **P PROGRAM AUTO (Factory default setting)**

Used for regular photography. The camera automatically makes the settings for natural color balance. Other functions, such as the flash mode and metering, can be adjusted manually.

● (Portrait)

Suitable for taking a portrait-style shot of a person. The camera automatically sets the optimal shooting conditions.

● (Landscape + Portrait)

Suitable for taking photos of both your subject and the landscape. The camera automatically sets the optimal shooting conditions.

● (Landscape)

Suitable for taking pictures of landscapes and other outdoor scenes. The camera automatically sets the optimal shooting conditions.

●  **(Night scene)**

Suitable for shooting pictures in the evening or at night. The camera sets a slower shutter speed than is used in normal shooting. If you take a picture of a street at night in any other mode, the lack of brightness will result in a dark picture with only dots of light showing. In this mode, the true appearance of the street is captured. The camera automatically sets the optimal shooting conditions. If you use the flash, you can take pictures of both your subject and the night background.



Normal shooting
(Flash fires.)



Night scene mode
(Flash fires.)

●  **(Self portrait)**

Enables you to take a picture of yourself while holding the camera. Point the lens at yourself and the focus will be locked on you.

The camera automatically sets the optimal shooting conditions. The zoom is fixed in the wide position and cannot be changed.



●  **(Movie)**

Lets you record movies. The camera maintains the correct focus and exposure even if your subject moves. You cannot record movies with sound.

 "Recording movies" (P.51)

**TIPS**

- For details of the functions for each mode "List of items by shooting mode" (P.133)



Note

- In the night scene mode, the sequential shooting is not available.
- In the self-portrait mode, the digital zoom, super macro and panorama shooting are not available.
- The prior flash setting is maintained in the night scene mode.
- The flash mode is set independently from the night scene mode.
 "Using the flash" (P.56)
- Since the shutter speed is slow, make sure you stabilize the camera by using a tripod or set it on a level surface.

Taking still pictures

You can take still pictures using either the monitor or the viewfinder. Both methods are easy as all you have to do is to press the shutter button. With the monitor, you can shoot while checking the picture area that the camera actually records.

1 Slide the power switch to , pressing and holding the lock button.

- The camera turns on in the shooting mode.
- The lens extends and the monitor turns on.

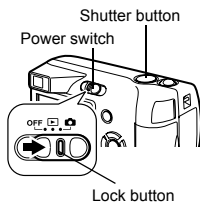

2 Decide the composition while looking at the image on the monitor.

- You can take pictures using the viewfinder, with the monitor turned off. When the monitor is off, the green lamp and  mark are not displayed.

 "Turning off the monitor" (P.47)

 "Comparison of the viewfinder & monitor" (P.46)

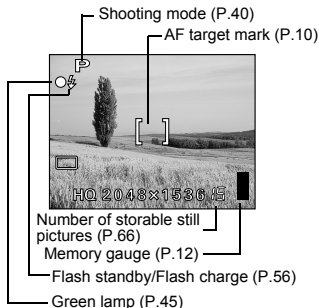

3 Press the shutter button gently (halfway) to adjust the focus.

- Focus and exposure are locked, when the green lamp lights steadily. (Focus Lock)
- When the flash is ready to fire, the ⚡ mark lights.

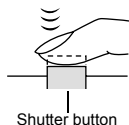

4 Press the shutter button all the way (fully).

- The camera takes the picture.
- The **BUSY** bar is displayed while the picture is stored on the card. The next shooting is available when the display goes off.

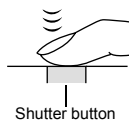

TIPS

Correct focus cannot be obtained on the subject you want to shoot.

→ "If correct focus cannot be obtained" (P.48)

The green lamp blinks.

→ You are too close to the subject. Take the picture at least 20 cm (7.9") away from the subject. If you use the super macro mode, you can take pictures as close as 2 cm/0.8" from the subject.

"Super macro mode shooting" (P.61)

→ Depending on the subject, the focus may not be locked.

"If correct focus cannot be obtained" (P.48)

The ⚡ mark blinks slowly when the shutter button is pressed halfway.

→ The flash is charging. Wait until the lamp goes off.

To check the picture you have just taken immediately.

→ Set REC VIEW to ON.

"REC VIEW" (P.95)

The monitor turns off automatically.

→ If the camera is not used for over 3 minutes, the monitor turns off automatically. Touch the shutter button or zoom lever to turn the monitor on.

The monitor is hard to see.

→ Bright light, such as direct sunlight, may cause vertical lines to appear on the monitor screen. In this case, use the viewfinder. (Note that this does not affect recorded pictures.)



Note

- Press the shutter button gently using the ball of your finger. If it is pressed hard, the camera may move, resulting in a blur.
- Never open the card cover, remove the batteries or disconnect the AC adapter while the **BUSY** bar is displayed on the monitor. Doing so could destroy stored pictures and prevent storage of pictures you have just taken.
- When taking pictures against strong backlight, the area of the picture in shadow may appear colored.

Comparison of the viewfinder & monitor

| | Viewfinder | Monitor |
|---------------|--|---|
| Advantages | Camera movement does not occur easily and subjects can be seen clearly even in bright places. Little battery power is used. | You can check the picture area that the camera actually records more accurately. |
| Disadvantages | When close to a subject, the image in the viewfinder is a little different from the picture that the camera actually records. | Camera movement can occur easily and subjects may be difficult to see in bright/dark places. The monitor uses more battery power than the viewfinder. |
| Tips | Use the viewfinder for general snapshots (landscape pictures, casual shots, etc.). | Use the monitor when you want to shoot while checking the picture area that the camera actually records, or when you take close-up shots of people or flowers (macro shooting). |

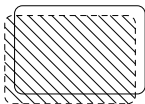

- The camera records a wider area than the image in the viewfinder.
- As you get closer to the subject, the actual image recorded becomes lower than the one in the viewfinder (see left).

Turning off the monitor

You can set whether or not the monitor is turned on when turning the camera on in the shooting mode.

1 Press .

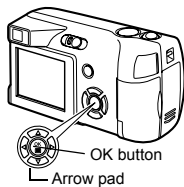

- The top menu is displayed.

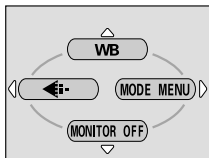

2 Press on the arrow pad (OFF).



3 The monitor turned off.

- Pressing  to display the top menu, and press  again turns the monitor on (ON).
- If the MONITOR OFF is set, the top menu displays MONITOR ON.

If correct focus cannot be obtained

When correct focus cannot be obtained on the subject you want to shoot, you can focus the camera on another point at roughly the same distance (focus lock) and take the picture as explained below.

Determine the position of the subject after focusing (Focus Lock)

- 1 Slide the power switch to , pressing and holding the lock button.**
 - The camera turns on in the shooting mode.
 - The lens extends and the monitor turns on.

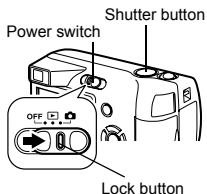

- 2 Position the AF target mark on the subject you want to focus on.**
 - When shooting a hard-to-focus subject, point the camera at an object about the same distance away as the subject.



AF target mark

- 3 Press the shutter button halfway until the green lamp lights.**
 - When the green lamp lights steadily, the focus and the exposure are locked.
 - When the green lamp blinks, the focus and exposure are not locked.

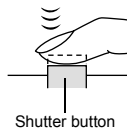

Release your finger from the shutter button, re-position your subject and press the shutter button halfway again.

- 4 Keeping the shutter button pressed halfway, recompose your shot.

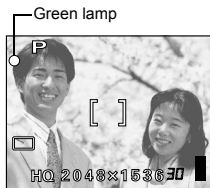

- 5 Press the shutter button fully.

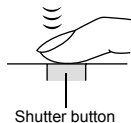

TIPS

The green lamp blinks.

- You are too close to the subject. Take the picture at least 20 cm (7.9") away from the subject. If you use the super macro mode, you can take pictures as close as 2 cm/0.8" from the subject.
 - ☞ "Super macro mode shooting" (P.61)
- Depending on the subject, the focus may not be locked.
 - ☞ "Subjects that are difficult to focus on" (P.50)

Subjects that are difficult to focus on

Under certain types of conditions, the auto focus may not work properly. If this happens, focus on an object with high contrast at the same distance as the intended subject (focus lock), recompose your shot and then take the picture. If the subject has no vertical lines, hold the camera vertically and focus the camera using the focus lock function by pressing the shutter button halfway, and return the camera to the horizontal position while keeping the button pressed halfway and take the picture.

The green lamp blinks.
The subject cannot be brought into focus.



Subject with low contrast



Subject with an extremely bright area in the center of the frame

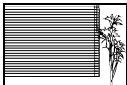

Subject without vertical lines

The green lamp lights, but the subject cannot be brought into focus.



Subjects at different distances



Fast-moving subject



The subject to be focused on is not in the center of the frame.

Recording movies



You can record movies with this camera. You can play back the recorded movies with this camera. Sound can not be recorded.

1 Slide the power switch to , pressing and holding the lock button.

- The camera turns on in the shooting mode.
- The lens extends and the monitor turns on.

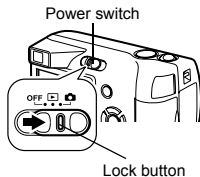

2 Press () to display the virtual dial screen.

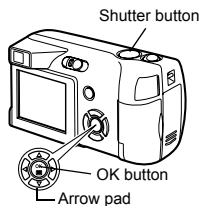

3 Press to select , then press .

- Movie recording is set and the camera returns to the shooting mode.
- On the monitor, the  mark and the remaining recording time of the current memory card are displayed.

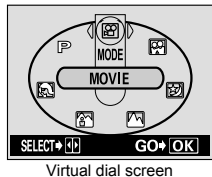

4 Decide the composition while looking at the image on the monitor.

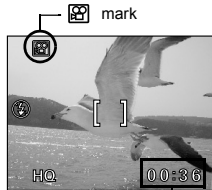

3

Shooting basics

5 Press the shutter button halfway.

6 Press the shutter button fully to start recording.

- When recording a movie, the camera automatically adjusts the focus and exposure according to the moving subject.
- During movie recording,  lights red.

7 Press the shutter button again to stop recording.

- When the remaining recording time has been used up, recording stops automatically.



Note

- During movie recording, the flash and super macro mode are disabled.
- It takes longer to store movies than still pictures.
- The maximum recordable time varies depending on the conditions such as the record mode.

Telephoto and wide-angle shooting are possible at 3x magnification (the optical zoom limit, equivalent to 38 mm – 114 mm on a 35 mm camera). By combining the optical zoom with the digital zoom, zoom magnification can be increased to a maximum of approximately 10x .

Using the optical zoom

- 1 Slide the power switch to , pressing and holding the lock button.**
 - The camera turns on in the shooting mode.
 - The lens extends and the monitor turns on.
- 2 Push/pull the zoom lever while observing the subject on the monitor.**

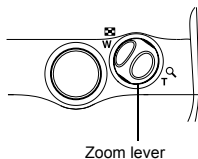
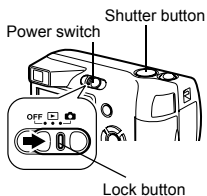



Wide-angle: Push the zoom lever toward W to zoom out.

Telephoto: Pull the zoom lever toward T to zoom in.



- 3 Take the picture.**

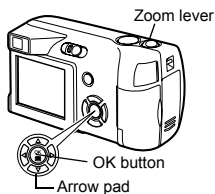
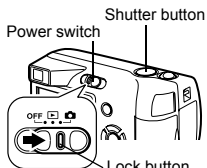

Using the digital zoom

- Slide the power switch to , pressing and holding the lock button.
 - The camera turns on in the shooting mode.
 - The lens extends and the monitor turns on.
- Press .
 - The top menu is displayed.



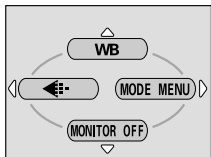

- Press  to select MODE MENU.

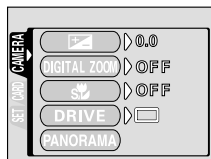

- Press   to select the CAMERA tab, and press .



- Press   to select DIGITAL ZOOM, and press .

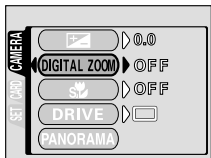

6 Press to select ON, and press .

- Press  again to exit the menu and return to the shooting status.

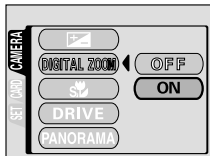

7 Pull the zoom lever toward .

- The white area of the zoom indicator indicates the optical zoom. If the digital zoom is set to ON, a red area appears on the zoom indicator. The digital zoom is enabled when you reach the limit of the optical zoom and then pull the zoom lever toward T.



The cursor moves up and down on the zoom indicator according to the zoom magnification.

8 Take the picture.



Note

- Pictures taken with the digital zoom may appear grainy.
- Camera movement is likely to occur at higher magnifications. Stabilize the camera with a tripod, etc. to avoid camera movement.
- Turning the monitor off cancels the digital zoom, and the camera takes a picture at the specified optical zoom magnification. It will be automatically enabled the next time you turn the monitor on.
- You cannot use the digital zoom in Self-Portrait mode.



Using the flash





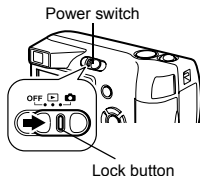

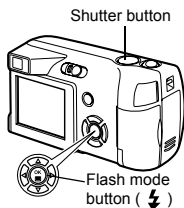

Select the flash mode best suited to the light conditions and the effect you want to achieve.

- 1 Slide the power switch to , pressing and holding the lock button.**
 - The camera turns on in the shooting mode.
 - The lens extends and the monitor turns on.



- 2 Press  ().**
 - The current flash setting is displayed.



- 3 Press  () to change the flash mode to your desired setting.**
 - Each time you press , the flash mode changes in the following sequence:
"Auto-flash" - "  Red-eye reduction flash" - "  Fill-in flash" - "  Flash off".





- 4 Press the shutter button halfway.**
 - When the flash is set to fire, the  mark remains lit.
- 5 Press the shutter button fully to take the picture.**

Flash working range
W (max.): Approx. 20 cm to 3.4 m (0.7 ft. to 11 ft.)
T (max.): Approx. 20 cm to 2.0 m (0.7 ft. to 7 ft.)





TIPS

- The  (flash standby) mark blinks.
→The flash is charging. Wait until the  mark lights.



Note

- The flash does not fire in the following situations:
When shooting in the movie record mode.
during sequential shooting (), panorama shooting or super
macroshooting ()
- The flash may not give you the optimum result in the macro mode,
especially with wide-angle shooting. Check the resulting picture on the
monitor.

● **Auto-flash (No indication)**

The flash fires automatically in low light or backlight conditions.

To shoot a subject with backlight, position the AF target mark over the subject.

● **Red-eye reduction flash ()**

The light from the flash may make the subject's eyes appear red in the picture. The red-eye reduction flash mode significantly reduces this phenomenon by emitting pre-flashes before firing the regular flash. This helps accustom the subject's eyes to the bright light and minimizes the red-eye phenomenon.

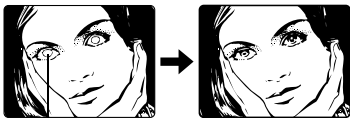

The subject's eyes appear red.



Note

- After the pre-flashes, it takes about 1 second before the shutter is released. Hold the camera firmly to avoid camera movement.
- Effectiveness may be limited if the subject is not looking directly at the pre-flashes, or if the shooting range is too far. Individual physical characteristics may also limit effectiveness.

● **Fill-in flash** (⚡)

The flash fires regardless of the available light. This mode is useful for eliminating shadows on the subject's face (such as shadows from tree leaves), in a backlight situation, or for correcting the color shift produced by artificial lighting (especially fluorescent light).



3



Note

- The fill-in flash may not have the desired effect under excessively bright light.

● **Flash off** (⚡)

The flash does not fire even in low light conditions. Use this mode in situations where flash photography is not desired or is prohibited. You can also use this mode when you want to shoot a natural-looking twilight or night scene.



Note

- Since a slow shutter speed is automatically selected in low light situations when in the flash off mode, the use of a tripod is recommended to prevent your pictures from being blurred by camera movement.

4 Advanced shooting

Macro mode shooting



Use the macro mode to shoot proximate subjects (W:20cm to 50cm/T:50cm to 90cm).

Regular photographs can be taken, but the camera may take time to focus on distant subjects.



Normal shooting



With macro mode





1 Set the power switch at .

- The lens extends and the monitor turns on.

2 Press (.

- The current setting is displayed.

3 Press (to switch the macro mode on or off.

- The setting changes between  ON and  OFF each time  is pressed. When the macro mode is selected,  is displayed on the monitor.

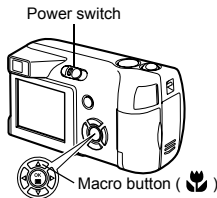

4 Take the picture.



Note

- If you are close to a subject, the picture in the viewfinder is different from the area that the camera actually records. For macro mode shooting, we recommend using the monitor.
- If you use the flash in macro shooting, shadows may be conspicuous and the correct exposure may not be achieved.



This mode lets you shoot from as close as 2 cm/0.8" to your subject. In the mode, normal shooting is also possible, but the position of the zoom is fixed automatically and cannot be changed.

- 1 In the shooting mode top menu, select MODE MENU → CAMERA → and press .**
 "How to use the menus" (P.32)

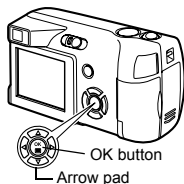

- 2 Press to select ON, and press .**
 - Press again to exit the menu.

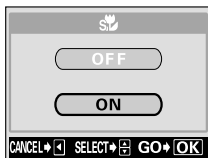

- 3 Take the picture.**



Note

- During super macro shooting, the zoom function or flash is not available.
- Super macro mode is disabled in the movie mode.
- When taking pictures close to the subject, shadows may become conspicuous, making it difficult to maintain correct focus.



This function is useful for taking pictures where you want to be included in the photograph. Fix the camera securely on a tripod or set it on a level surface for self-timer shooting.

1 Set the power switch at

- The lens extends and the monitor turns on.

2 Press ().

- The current self-timer setting is displayed.

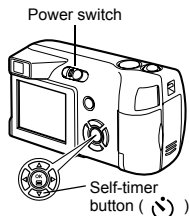

3 Press () to switch the self-timer mode on or off.

- The setting changes between ON and OFF each time is pressed. When the self-timer mode is selected, is displayed on the monitor.



4 Take the picture.

- The self-timer lamp lights up for approximately 10 seconds, and starts blinking. After blinking for approximately 2 seconds with a beep sound, the picture is taken.
- The self-timer mode is automatically canceled after one shot.

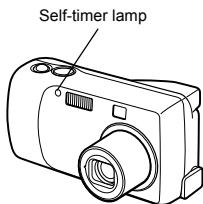



This function allows you to take a rapid succession of still pictures by pressing and holding the shutter button (approximately 12 pictures at 1.5 frames per second only by sequential shooting in SQ2 mode). As you can choose the best picture from a series of sequential shots, you are recommended to use this mode when taking pictures of a moving subject. Focus, exposure and white balance are locked at the first frame. You can also erase the unwanted shots afterwards. "Single-frame erase" (P.83)

- 1 In the shooting mode top menu, select MODE MENU → CAMERA → DRIVE, and press .**

"How to use the menus" (P.32)

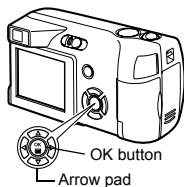

- 2 Press to select , and press .**
 - Press again to exit the menu.

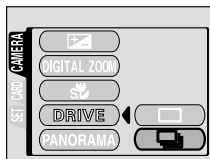

- 3 Take the picture.**

- Press the shutter button fully and keep it pressed. The camera will take pictures in sequence until you release the button.





Note

- When the sequential shooting mode is set, the record mode setting is fixed to SQ2. When the sequential shooting mode is canceled, the record mode setting returns to the previous setting.
- The sequential shooting mode is canceled when the power is turned off. "ALL RESET - Saving the camera's settings" (P.89)
- During sequential shooting, the flash is disabled.
- If the battery power is low and the battery check blinks during sequential shooting, shooting stops and the camera starts saving the pictures you have taken. Whether or not all of the shots are saved depends on how much battery power remains.

PANORAMA

You can take advantage of panorama shooting with the Olympus xD-Picture Card. Panorama shooting lets you connect pictures with overlapping edges into a single panoramic picture, using the CAMEDIA Master software.

- 1** In the shooting mode top menu, select **MODE MENU** → **CAMERA** → **PANORAMA**, and press .

 "How to use the menus" (P.32)

- The PANORAMA mode is set. The subject is displayed on the monitor.

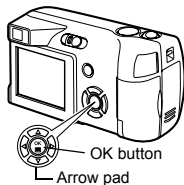

- 2** On the monitor, use the arrow pad to choose the direction you want the pictures connected.

 : Connects the pictures from left to right.

 : Connects the pictures from right to left.

 : Connects the pictures from bottom to top.

 : Connects the pictures from top to bottom.

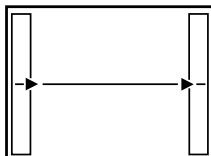

Connects the pictures from left to right.

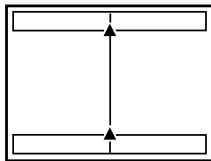

Connects pictures from bottom to top.

3 Make sure that the edges of the pictures overlap, and take pictures.

- Focus, exposure and white balance are set by the first picture. Do not select an extremely bright subject (such as the sun) for the first picture.
- You cannot adjust the zoom after the first picture.
- Panorama shooting is possible for up to 10 pictures.

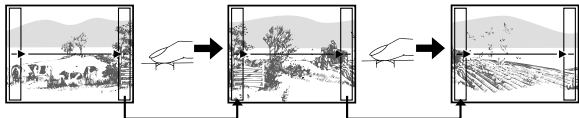

When shooting, make sure that the edges (right/left/top/bottom) of the images overlap, so that the CAMEDIA Master software can correctly connect the pictures.

- When you have taken 10 pictures, the end mark appears.



4 Press to finish panorama shooting.

- The frame on the screen disappears and the camera returns to the normal shooting mode.



Note

- The panorama mode is only available with Olympus CAMEDIA-brand cards.
- During panorama shooting, sequential shooting is not available.
- The camera itself cannot connect panorama pictures. The CAMEDIA Master software is necessary to connect the pictures.

Selecting a record mode



You can select a record mode in which to take pictures or shoot movies. Choose the best record mode for your purpose (printing, editing on a PC, website editing, etc.). For details of the available record mode and resolutions, and the number of still pictures or the movie recording time allowed on the card, refer to the table on the next page. The numbers in the table are approximate.

| Application | Compression | | Image becomes clearer ← | |
|-----------------------------------|-------------|-----------------|-------------------------|--|
| | Resolution | Low compression | High compression | |
| Select for the print size | 2048 × 1536 | SHQ | HQ | |
| | 1600 × 1200 | | SQ1 | |
| For small sized print and website | 640 × 480 | | SQ2 | |

Number of pixels increases ↑

4

Still Picture Record Modes

| Record mode | Resolution (No. of pixels) | Memory capacity in number of shots (using a 16 MB card) |
|-------------|----------------------------|---|
| SHQ | 2048 x 1536 | 6 |
| HQ | | 20 |
| SQ1 | 1600 x 1200 | 32 |
| SQ2 | 640 x 480 | 165 |

Movie Record Modes Maximum time for one recording (sec)

| Record mode | Resolution | Remaining recording time (using a 16 MB card) |
|-------------|------------|---|
| HQ | 320 x 240 | 48 sec. |
| SQ | 160 x 120 | 3 min. 31 sec. |

The time remaining for recording movies (Total recording time) in the card is displayed on the monitor when the camera is set to the movie record mode ().



Note



- The card memory capacity listed in the table is approximate.
- The number of remaining pictures may change according to the subject or factors like whether print reservations have been made or not. In certain instances, the number of remaining pictures displayed on the monitor does not change even when you take pictures or stored images are erased.

**TIPS****• Resolution**

The number of pixels (horizontal x vertical) used when saving an image. If the image will be printed, higher resolutions (larger numbers) are recommended so that the image will be clearer. However, higher resolutions make the file size (amount of data) larger, so the number of pictures that can be saved will be fewer.



• Resolution and picture size on a computer screen

When a picture is transferred to a computer, the size of the picture on the computer screen varies depending on the computer's monitor setting. For instance, a picture taken in 1024 x 768 resolution is the same size as the screen if you set the picture to 1x when the monitor setting is 1024 x 768. However, if the monitor setting is over 1024 x 768 (such as 1280 x 1024), the picture only takes up part of the screen.

- 1** In the shooting mode top menu, press  to select .

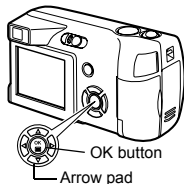
 "How to use the menus" (P.32)



- 2** Press   to select the desired record mode.

• For still pictures, you can choose from SHQ, HQ, SQ1 and SQ2.

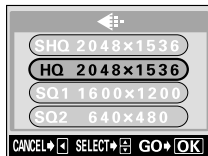

• For movies, you can choose HQ or SQ.

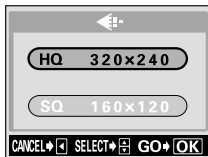

- 3** Press .

• Press  again to exit the menu.





Note

• The record mode setting returns to HQ (factory default setting) when the power is turned off.  "ALL RESET - Saving the camera's settings" (P.89)

Varying the image brightness (Exposure compensation)



This function allows you to make fine changes to the automatic exposure setting. In some situations, you may get better results when the exposure that the camera sets is compensated (adjusted) manually. You can adjust the exposure in the range of ± 2.0 in 0.5EV steps.

When the setting is changed, you can check the result on the monitor.

- 1 In the shooting mode top menu, select MODE MENU \rightarrow CAMERA \rightarrow , and press .**

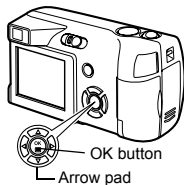
 "How to use the menus" (P.32)



- 2 Press   to select the exposure compensation value.**

- Select a [+] value to brighten the image or a [-] value to darken the image.

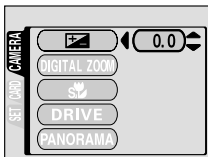

-2.0



0.0



+2.0

- 3 Take the picture.**



TIPS

- Often bright subjects (such as snow) will turn out darker than their natural colors. Adjusting toward + makes these subjects closer to their real shades. For the same reason, adjust toward - when shooting dark subjects.



Note





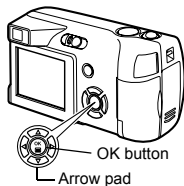

- The exposure compensation value returns to 0.0 (factory default setting) when the power is turned off.  "ALL RESET - Saving the camera's settings" (P.89)
- If the flash is used, the image brightness (exposure) may differ from the intended brightness.
- Exposure compensation cannot correct the image if the surroundings of the subject are extremely bright or dark.

Color reproduction differs depending on the light conditions. For instance, when daylight, the setting sun, or tungsten lighting are reflected on white paper, the shade of white produced will be slightly different for each. By setting the WB (white balance), you can achieve more natural-looking colors.

- 1 In the shooting mode top menu, press  to select WB.**





 "How to use the menus" (P.32)

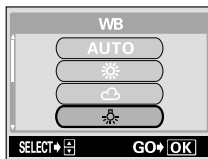



- 2 Press   to select the white balance best suited to the shooting conditions. Choose from AUTO, , ,  and .**



AUTO (No indication) : The white balance is adjusted automatically so that colors look natural irrespective of the light source.

-  (Sunlight) : For natural colors under a clear sky.
 (Overcast) : For natural colors under a cloudy sky.
 (Tungsten) : For natural colors under tungsten lighting.
 (Fluorescent) : For natural colors under fluorescent lighting.

- 3 Press .**
 - Press  again to exit the menu.

- 4 Take the picture.**



Note

- The white balance setting returns to AUTO (factory default setting) when the power is turned off.  "ALL RESET - Saving the camera's settings" (P.89)
- White balance may not be effective under some special light sources.
- After setting a white balance other than AUTO, play back the picture and check the colors on the monitor.
- When the flash is fired with a white balance setting other than AUTO, colors may appear different in the resulting picture from the colors you see on the monitor.

5 Playback

Viewing still pictures



- 1 Set the power switch at .

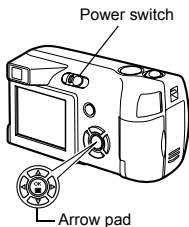

- The monitor turns on and displays the last picture taken. (Single-frame playback)



- 2 Use the arrow pad to play back other pictures.

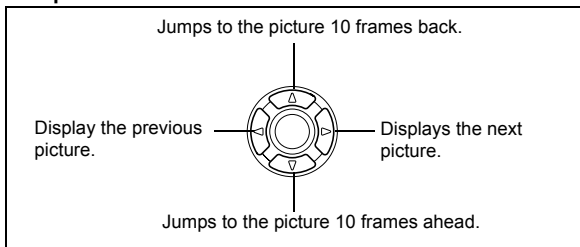

- 3 Set the power switch at OFF.

- The monitor and camera turn off.



Note

- If the camera is not used for over 3 minutes, the monitor and camera turn off automatically.

5

Playback

QUICK VIEW

This function lets you play back pictures while the camera is in the shooting mode. This is useful when you want to check shooting results and resume shooting quickly.

Functions available in normal playback mode are also available in Quick View.

1 Press QUICK VIEW button while in the shooting mode.

- The camera immediately enters the playback mode and displays the last picture taken. (Single-frame playback)

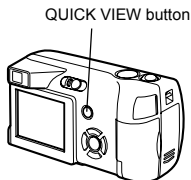



2 Press the shutter button halfway or QUICK VIEW button to return to the shooting mode.

- The camera returns to shooting mode, and is ready to take pictures.
- Press the shutter button all the way (fully) to return to the shooting mode and take a picture immediately.



Close-up playback

Pictures displayed on the monitor can be enlarged in steps up to 4 times the original size.

- 1 Set the power switch at .**
 - The monitor turns on and displays the last picture taken. (Single-frame playback)

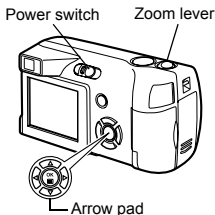
- 2 Use the arrow pad to display the still picture you want to enlarge.**
 - You cannot enlarge pictures with .



- 3 Pull the zoom lever toward .**
 - The magnification increases each time the zoom lever is pulled. To return the picture to the original size (1x), push the zoom lever toward .
 - By using the arrow pad while the enlarged picture is displayed, you can shift the picture in the desired direction, enabling you to view a different portion.

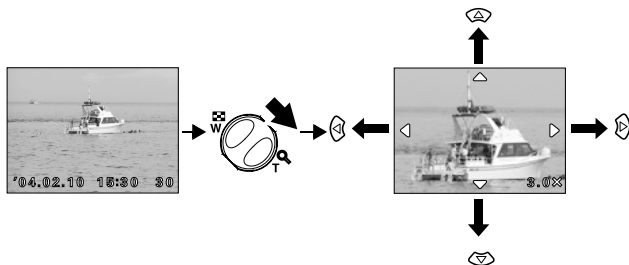

Note

- Pictures cannot be stored in an enlarged state.

Picture rotation



Pictures taken with the camera held vertically are displayed horizontally. This function lets you turn such pictures 90 degrees clockwise or counterclockwise so that they are displayed vertically.

- 1 In the playback mode top menu, select MODE MENU → PLAY →**
, and press .

➔ "How to use the menus" (P.32)

- 2 Press   to select +90° or -90°.**

- The picture is rotated, and displayed vertically.
- To close the menu, press  twice.

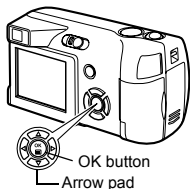

5

Playback

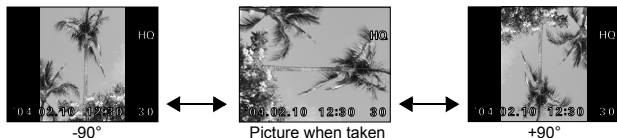

Note

- The following pictures cannot be rotated.
Movies, protected pictures, pictures that have been edited on a PC and pictures taken with another camera.
- New picture orientations are saved even when the power is turned off.



This function lets you show several pictures at the same time on the monitor. The number of pictures shown can be 4, 9 or 16. "Selecting the number of pictures" (P.78)

1 Set the power switch at

- The monitor turns on and displays the last picture taken. (Single-frame playback)

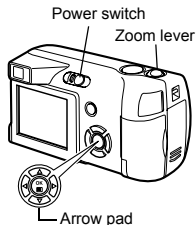

2 Push the zoom lever toward to enter the index display mode.

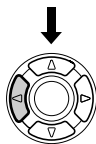
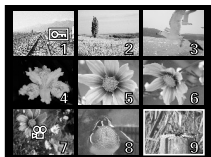

- Use the arrow pad to select the picture.
 - : Moves to the next frame.
 - : Moves to the previous frame.
 - : Jumps to the previous index display (the frames before the top left frame).
 - : Jumps to the next index display (the frames following the bottom right frame).
- To return to the single-frame playback, pull the zoom lever toward .

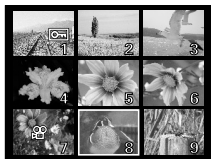

5

Playback



Selecting the number of pictures

This function lets you select the number of pictures in an index display from 4, 9 and 16.

- 1** In the playback mode top menu, select **MODE MENU** → **SETUP** → , and press .

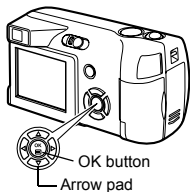
 "How to use the menus" (P.32)



- 2** Press   to select **4, 9 or 16,** and press .

• Press  again to exit the menu.

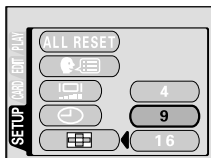





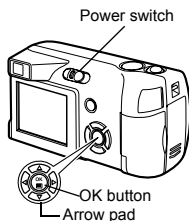

This function displays still pictures stored in the card one after another. Only the first frame of movies are played back.

- 1 Set the power switch at .**
 - The monitor turns on and displays the last picture taken. (Single-frame playback)

- 2 Display a still picture, and press  to display the top menu.**



- 3 Press  () to start the slideshow.**

- 4 Press  to stop the slideshow.**
 - The slideshow will not stop until you cancel it by pressing .





TIPS

- You are recommended to use the optional AC adapter when running a slideshow for a long period of time. If batteries are used, the camera will stop the slideshow after about 30 minutes and turn off.

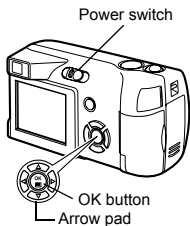

- 1 Set the power switch at .**
 - The monitor turns on and displays the last picture taken. (Single-frame playback)



- 2 Use the arrow pad to display the picture with .**
 - "Viewing still pictures" (P.73)



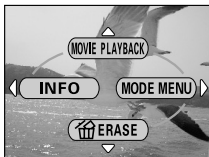

- 3 Press .**
 - The top menu is displayed.

- 4 Press  to select MOVIE PLAYBACK.**





5 Press to select **PLAYBACK**, and press .

- The movie is played back. When playback ends, the display automatically returns to the beginning of the movie.
- Fast forward/fast rewind functions are available during playback.
 -  : Fast forward. Each press switches the speed between $\times 1$, $\times 2$ and $\times 20$.
 -  : Fast rewind. Each press switches the speed between $\times 1$, $\times 2$ and $\times 20$.
- The MOVIE PLAYBACK menu is displayed again after playback ends.

PLAYBACK: Plays back the entire movie again.





FRAME BY FRAME: Plays back the movie manually one frame at a time.

EXIT: Leaves the movie playback mode.

Press   to select from **PLAYBACK**, **FRAME BY FRAME** or **EXIT**, and press .



● When FRAME BY FRAME is selected

-  : Displays the first frame of the movie.
-  : Displays the last frame of the movie.
-  : Displays the next frame. The movie can be played continuously by holding the button down.
-  : Displays the previous frame. The movie can be played continuously in reverse by holding the button down.
-  : Displays the MOVIE PLAYBACK menu.



TIPS

- Movies can also be played back in the shooting mode using QUICK VIEW.  "QUICK VIEW" (P.74)



Note

- The access time to play a movie varies depending on the total recorded time and the record mode of the movie.

You are recommended to protect important pictures to avoid accidentally erasing them. Protected pictures cannot be erased by the single-frame/all-frame erase function.

- 1 Set the power switch at .**
 - The monitor turns on and displays the last picture taken. (Single-frame playback)

- 2 Use the arrow pad to display the picture you want to protect.**

 "Viewing still pictures" (P.73)

- 3 Press .**

• The top menu is displayed.

- 4 In the top menu, select MODE MENU → PLAY → , and press .**

 "How to use the menus" (P.32)

- 5 Press   to select ON, and press .**

• To cancel protection, select OFF.

• Press  again to the menu.

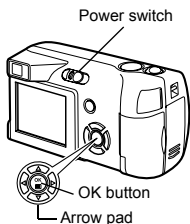

Displayed when a picture is protected.



Note

- Protected pictures cannot be erased by the single-frame/all-frame erase functions, but they are all erased when you execute format.



This function enables you to erase recorded pictures. You can choose the single-frame erase or the all-frame erase.



- You cannot erase pictures that are protected. Cancel the protection before erasing such pictures.
- Note
- Once erased, pictures cannot be restored. Be careful not to accidentally erase pictures you want to keep. "Protecting pictures" (P.82)

Single-frame erase

This function erases only the picture displayed on the monitor. The all-frame erase function can be used to erase all the pictures on the card at once.

"All-frame erase" (P.84)

1 Set the power switch at .

- The monitor turns on and displays the last picture taken. (Single-frame playback)

2 Use the arrow pad to display the picture you want to erase.

"Viewing still pictures" (P.73)

3 Press .

- The top menu is displayed.

4 Press to select ERASE.

5 Press to select YES, and press .

- The picture is erased and the menu is closed.

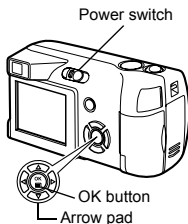





All-frame erase

This function erases all the pictures on the card.

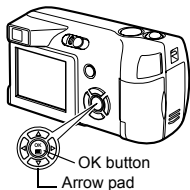
- 1** In the playback mode top menu, select **MODE MENU** → **CARD** → **CARD SETUP**, and press .

 "How to use the menus" (P.32)



- 2** Press   to select  **ALL ERASE**, and press .

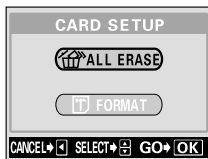

- 3** Press   to select **YES**, and press .

• All the pictures are erased.



Editing still pictures (Resizing)

Changes the recorded still picture size to 640 x 480 or 320 x 240 and stores the picture as a new picture.

1 Set the power switch at .

- The monitor turns on and displays the last picture taken. (Single-frame playback)

2 Use the arrow pad to display the still picture you want to edit.

-  "Viewing still pictures" (P.73)

3 Press .

- The top menu is displayed.

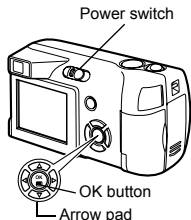

4 In the top menu, select **MODE MENU** → **EDIT** → , and press .

-  "How to use the menu" (P.32)



5

Playback

5 Press   to select the new picture size, and press .

- The **BUSY** bar is displayed, and the camera returns to the playback mode. The newly created picture is stored as a separate picture from the original.
- To quit the resizing function, select CANCEL, and press .



Note

- Resizing is not possible in the following cases.
 - Movies, pictures that have been edited on a PC, or when there is insufficient memory space on the card.
 - If the size of the selected picture is 640 x 480, you cannot select 640 x 480.

Editing movies (INDEX-Creating an index)

This function lets you create indexes of the recorded movies.

INDEX 9 frames extracted from a movie are displayed as an index to show the movie at a glance. Indexes can be stored on the card as a still picture.

1 Set the power switch at .

- The monitor turns on and displays the last picture taken. (Single-frame playback)

2 Use the arrow pad to select a picture with .

- ➔ "Viewing still pictures" (P.73)

3 Press .

- The top menu is displayed.

4 In the top menu, select MODE MENU → EDIT → INDEX, and press .

- ➔ "How to use the menus" (P.32)

5 Select the first frame of the index.

Press the arrow pad to play back the movie until the picture that you want as the first frame is displayed in the green frame at the upper left corner, and press .

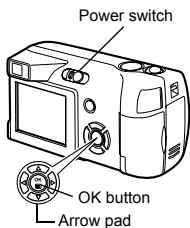



5

Playback

6 Select the last frame of the index.

As in Step 5, press the arrow pad to play back the movie until the picture that you want as the last frame is displayed in the green frame at the lower right corner, and press .

**7 Press  to select OK, and press .**

- The 9 frames extracted from the movie appear as an index display, and the camera returns to the playback mode. The index is stored as a new picture.
- If you want to select the frames again, select RESET and press  and repeat the procedure from Step 5.
- To cancel the index function, select CANCEL and press .

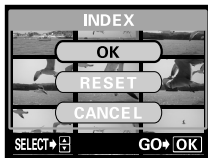
**TIPS**

- The index is stored as a still picture in a different record mode from the original movie.

| Record mode when the movie is shot | Record mode when stored as an index |
|------------------------------------|-------------------------------------|
| HQ | 1024 x 768 pixels |
| SQ | 640 x 480 pixels |



Note

- The interval between the frames that are automatically picked out varies depending on the recording time of the movie.
- An index consists of 9 frames.
- You cannot create an index if there is insufficient memory space on the card.

6 Useful functions

ALL RESET - Saving the camera's settings

This function lets you choose whether or not to save the current camera settings after the power is turned off. The settings affected by ALL RESET are listed on the next page.

The ALL RESET setting (ON/OFF) applies to all the modes. If ALL RESET is set to OFF in one mode, this setting applies to all the other modes, both shooting and playback.

ON : All settings are returned to the factory default settings after the power is turned off.

For example: If you set  to SQ1 before turning off the power, this setting will be returned to the factory default setting, HQ, when the power is turned on again.

OFF : The settings made before the power is turned off are saved.

1 In the top menu, select **MODE MENU** → **SETUP** → **ALL RESET** → **OFF or ON**, and press .

 "How to use the menus" (P.32)

- Press  again to exit the menu.

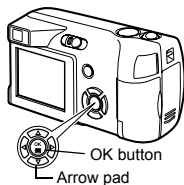





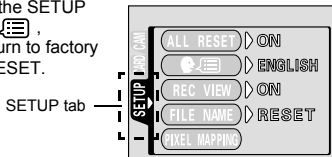

Note

- The functions provided on the SETUP tab of the mode menu (, REC VIEW etc.) do not return to factory default setting with ALL RESET.



● Functions that All Reset affects and their factory default settings

| Function | Factory default setting | Ref. Page |
|---|--|-----------|
| WB | AUTO | P.71 |
| Monitor | ON | - |
| DRIVE |  (for still pictures) | P.63 |
|  | HQ | P.66 |
| Shooting modes | P (PROGRAM AUTO) | P.41 |
|  | AUTO | P.56 |
|  | OFF | P.59 |
|  | 0.0 | P.69 |
| DIGITAL ZOOM | OFF (1x) | P.54 |
|  | OFF | P.61 |
| INFO | OFF | P.93 |



This function lets you format a card. Formatting prepares cards to receive data. Before using non-Olympus cards or cards which have been formatted on a PC, you must format them with this camera.

All existing data, including protected pictures, are erased when the card is formatted. Make sure that you transfer important data to a PC before formatting a card in use.



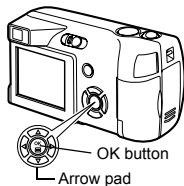

1 In the top menu, select **MODE MENU** → **CARD** → **CARD SETUP**, and press .

 "How to use the menus" (P.32)

- Shooting mode
The  **FORMAT** screen is displayed.
- Playback mode
The **CARD SETUP** screen is displayed.



2 If the **FORMAT** screen is displayed, press to select **YES**.

If the **CARD SETUP** screen is displayed, press   to select  **FORMAT**, and press .

When the  **FORMAT** screen appears, press  to select **YES**.

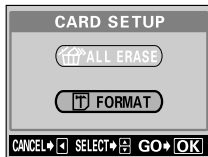
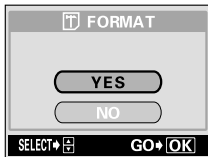

3 Press .

- The **BUSY** bar is displayed and the card is formatted.

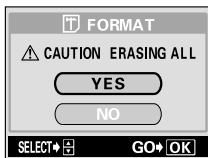

Note

- Never do the following during formatting, as they may cause the card to malfunction.
 - Open the card cover.
 - Remove the battery.
 - Connect or disconnect the AC adapter.

This function lets you display detailed shooting information on the monitor for 3 seconds in the playback mode. For details of the information displayed, see "Monitor indications" (P.10).

1 Pressing in the playback mode top menu displays the full amount of shooting information on the monitor (On).

- "How to use the menus" (P.32)
- To turn INFO off, press to bring up the top menu and press (Off).

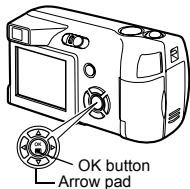

When INFO is Off



When INFO is On



Note

- If the picture has been taken with a different camera, only the date/time, file number and battery level are displayed when INFO is set to On.
- The file number used to specify an image when making non-DPOF print reservations is displayed when INFO is set to ON. "With print reservation" (P.98)

Adjusting the monitor brightness



This function lets you adjust the brightness of the monitor. The brightness can be adjusted in either the shooting mode or the playback mode.



- 1** In the top menu, select **MODE MENU** → **SETUP** → , and press

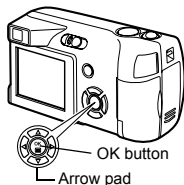

 "How to use the menus" (P.32)



- 2** Press   to adjust the brightness of the monitor, and when you have set the desired level, press .

- Pressing  brightens the monitor, and pressing  darkens it.
- Press  again to exit the menu.



REC VIEW

You can choose whether or not to have the picture you have just taken displayed briefly on the monitor.

- ON** : The picture being recorded to the card is displayed. This is useful for making a quick check of the picture you have just taken. You can resume shooting anytime during REC VIEW.
- OFF** : The picture being recorded to the card is not displayed. This is useful when you want to prepare for your next shot while the previous picture is being recorded.

1 In the shooting mode top menu, select MODE MENU → SETUP → REC VIEW → OFF or ON, and press



the "How to use the menus" (P.32)

- Press  again to exit the menu.

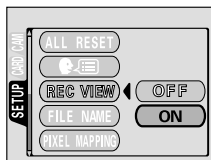
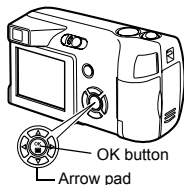

Note

- If the batteries are running low when you take a picture with the monitor off and REC VIEW is set to ON, the picture may not be displayed.

FILE NAME

The camera automatically creates file names and folder names for images to be stored in. Files can be numbered from 0001 to 9999 and folders can be numbered from 100 to 999. Examples are shown below.

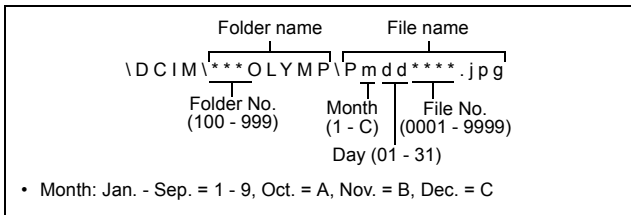

There are two settings from which you can choose: RESET or AUTO. Choose the one that is best for you when transferring images to a PC.

File name settings

RESET : The file number and folder number are reset every time a new card is inserted in the camera. The folder number returns to No. 100 and the file number returns to No. 0001. This method is useful when grouping files on separate cards.

AUTO : Even if a new card is inserted, the folder number and file number are retained from the previous card, so the same file number is not used on different cards. This helps you to manage multiple cards. This method is useful when you want to manage all your files with sequential numbers.

6

Useful functions

- 1 In the shooting mode top menu, select MODE MENU → SETUP → FILE NAME → RESET or AUTO, and press .**

 "How to use the menus" (P.32)

- Press  again to exit the menu.

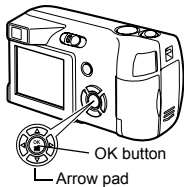



Note

- When the File No. reaches 9999, the file number returns to 0001 and the folder number changes.
- When both the Folder and File No. reach their respective maximum number (999/9999), the number of storable pictures becomes 0 even if the card is not full. No more pictures can be taken. Replace the card with a new one.

PIXEL MAPPING

The Pixel Mapping feature allows the camera to check and adjust the CCD and image processing functions. It is not necessary to operate this function frequently. Approximately once a year is recommended. Wait over a minute after the monitor is used or continuous shots are taken to allow for proper performance of the Pixel Mapping function.

1 In the shooting mode top menu, select MODE MENU → SETUP → PIXEL MAPPING, and press .

 "How to use the menus" (P.32)

- START is displayed.

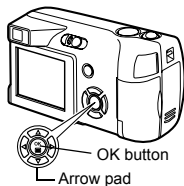

2 Press .

- The **BUSY** bar is displayed during Pixel Mapping. When Pixel Mapping is finished, the screen returns to the mode menu.



Note

- If you accidentally turn the camera off during Pixel Mapping, start again from step 1.

7 Print setting (DPOF)

With print reservation



Print reservation allows you to save printing data (the number of prints and the date/time information) with the pictures stored on the card.

With print reservation, you can print out pictures easily either at home using a personal DPOF-compatible printer or at a print shop that supports DPOF. DPOF is a standard format used to record automatic print information from digital cameras. You can print out pictures automatically, at home or in a print shop, by storing such data as which pictures you wish to print and the number of prints on a card.

Pictures taken with print reservation can be printed using the following procedures.

Printing using a DPOF-compatible print shop.

You can print the pictures using the print reservation data.

Printing using a DPOF-compatible printer.

Printing is possible directly from a card containing print reservation data without using a PC. For more details, refer to the printer's instruction manual. A PC card adapter may also be necessary.

**TIPS****Picture size and printing**

The resolution of a computer/printer is generally based on the number of dots (pixels) per inch. This is called dpi (dots per inch). The higher the dpi value, the better the printed results. Keep in mind, however, that the dpi of the picture does not change. This means that when you print an image with a higher resolution, the size of the printed picture will be smaller. Although you can print magnified images, picture quality will decrease. If you want to print large, high-quality pictures, set the record mode as high as possible when taking the pictures.  "Selecting a record mode" (P.66)



Note

- DPOF reservations set by another device cannot be changed by this camera. Make changes using the original device.
- If a card contains DPOF reservations set by another device, entering reservations using this camera may overwrite the previous reservations.
- The allowable number of pictures for DPOF reservation is 999 frames per card.
- Print reservation may not be available if there is insufficient card memory. In this case, the CARD FULL message is displayed.
- Not all functions may be available on all printers or at all print shops.
- Print reservation may take considerable time when saving printing data to a card.

All-frame reservation



Use this feature to print all pictures stored on the card. Select the desired number of prints and whether you want the date and time included.

1 Play back a still picture.

- You cannot print pictures with

2 In the top menu, select MODE MENU → PLAY → , and press .



▶ "How to use the menus" (P.32)

- If print reservation data is already stored on the card, the PRINT ORDER SETTING screen appears, giving you the choice of resetting the data or keeping it. Select KEEP and press .

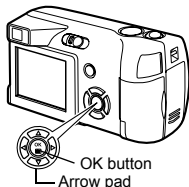

3 Press to select (all-frame reservation), and press .

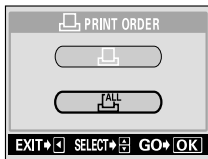

PRINT ORDER screen

4 Press to select x (number of prints) or (date/time), and press .

5 Perform each setting as illustrated.

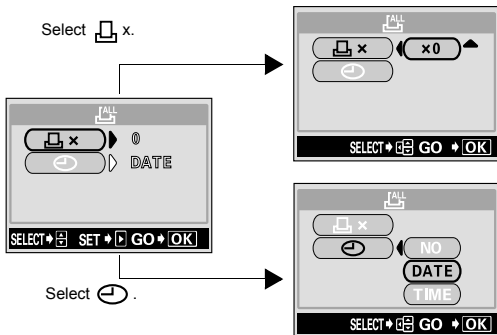

● Set the number of prints

Press to set the desired number of prints, and press .

If you want to continue to set the date/time printing data, press to return to Step 4.

- : Increases the number.
- : Decreases the number.

● Set the date/time printing data

Press to select NO, DATE or TIME, and press .

- NO** : The pictures are printed without the date and time.
- DATE** : All the pictures are printed with the shooting date.
- TIME** : All the pictures are printed with the shooting time.

- After completing all the print reservations, press to return to the playback mode menu.

Single-frame reservation



Use this feature to print only selected pictures. It is also used to change the reserved number of prints and the date/time settings. Display the frame you want to print and set the desired number of copies.

1 Play back a still picture.

- You cannot print pictures with

2 In the top menu, select MODE MENU → PLAY → , and press



- "How to use the menus" (P.32)
- If data is already stored on the card, the PRINT ORDER SETTING screen appears, giving you the choice of resetting the data or keeping it. Select KEEP and press .

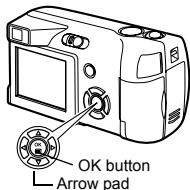

3 Press to select (single-frame reservation), and press .

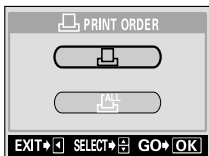

PRINT ORDER screen

4 Press the arrow pad to display the frame you want to print, and press



- You can use the index display feature to select the frames. "Index display" (P.77)



5 Select the appropriate item using the arrow pad.

- MORE** : Sets the number of prints and date/time. → Go to Step 6.
- SINGLE PRINT** : Sets single-frame print. The date/time settings are not available. The print reservation is set. Return to Step 4.
- CANCEL** : Cancels the reservation of the picture displayed on the screen. "Resetting print reservation data" (P.105)
- END** : Completes the print reservation. → Go to Step 11.

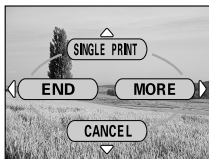

6 Press on the arrow pad to select x (number of prints) or (date/time), and press .



7 Perform each setting.

● Set the number of prints

Press to set the desired number of prints, and press .

If you want to continue to set the date/time printing data, press to return to Step 6.

- : Increases the number.
- : Decreases the number.



● Set the date/time printing data

Press to select NO, DATE or TIME, and press .

- NO** : The pictures are printed without the date and time.
- DATE** : All the pictures with print reservation are printed with the shooting date.
- TIME** : All the pictures with print reservation are printed with the shooting time.

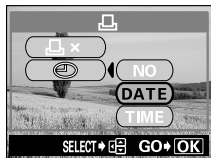

8 After setting the number of prints and the date/time printing data, press again to complete the print reservations, and return to the screen in Step 4.

- mark is displayed on the image displayed on the screen.

9 Press to display the single-frame reservation menu.



10 Press to select END.

- The PRINT ORDER screen appears.
- Press again to display the PRINT ORDER SETTING screen, and press once more to return to the playback mode menu.

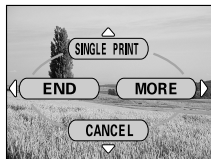

Single-frame reservation menu screen

11 Press to return to the mode menu.

- Press to close the menu.

Resetting print reservation data



This function allows you to reset the print reservation data for the pictures stored on the card.

There are two ways to reset the print reservation data. One is to reset the print reservation data for all the frames. The other is to reset the print reservation data for the unwanted frames only.

1 Play back the still picture marked



2 In the top menu, select MODE MENU → PLAY →



"How to use the menus" (P.32)

- The PRINT ORDER SETTING screen appears.

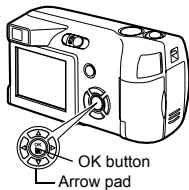

3 When resetting the print reservation data for all the frames, press

To reset the print reservation data for the unwanted frame

only, press

4 PRINT ORDER SETTING screen is displayed. Press



SINGLE PRINT, and press

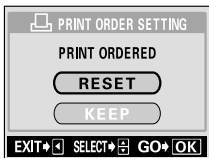

PRINT ORDER SETTING screen

7

Print setting (DPOF)

5 Use the arrow pad to display the frame that has the print reservation data you want to reset, and press



- The Single-frame reservation menu screen appears.





6 Press  to select CANCEL.

- The selected print reservation data is canceled and the camera returns to the screen in Step 5.



Single-frame reservation menu screen

7 When there are not any other print reservation data to be reset, press  to display the Single-frame reservation menu screen, and press .

8 Press  to return to the mode menu.



- Press  to close the menu.

8 Direct printing (PictBridge)

Using the direct printing function

By connecting the camera to a PictBridge-compatible printer with the USB cable, you can print out recorded pictures directly without the use of a computer. With the camera connected to the printer, use the camera's monitor to select the pictures you want to print, and the number of prints you want to make. It is also possible to print out pictures using the print reservation data.  "Print setting (DPOF)" (P.98)
To find out if your printer is compatible with PictBridge, refer to the printer's instruction manual.

What is PictBridge? ... It is the standard for connecting digital cameras and printers of different makers and printing out pictures directly.

 **STANDARD** ... All printers that support PictBridge have standard print settings. Selecting  STANDARD on the settings screens ( P.110 to 118), images are printed according to the default settings. See the instruction manual for your printer for its standard settings or inquire with the printer manufacturers.



TIPS

- For details of printing paper types, ink cassettes, etc., refer to the printer's instruction manual.



Note

- You are recommended to use the optional AC adapter for the camera when printing pictures directly. If you use the battery, make sure that it is fully charged. If the camera stops operating while communicating with the printer, the printer may malfunction or image data may be lost.
- Images recorded in movies cannot be printed.
- The camera will not enter sleep mode when connected to the USB cable.

Connecting the camera to a printer

Use the USB cable provided with the camera to connect the camera to a PictBridge-compatible printer.

1 Turn the printer on and plug the printer end of the USB cable into the printer's USB port.

- For details of how to turn the printer on and the position of the USB port, refer to the printer's instruction manual.

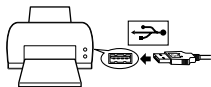

2 Plug the other end of the USB cable into the camera's USB connector.

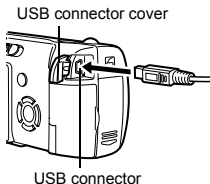

3 Set the power switch at .

- The monitor turns on and the selection screen for the USB connection is displayed.

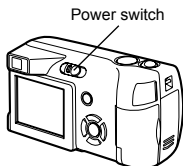

4 Press to select PRINT, then press .

- When the camera is connected to the USB cable, the self-timer lamp lights.
- ONE MOMENT is displayed and the camera and printer are connected. The PRINT MODE SELECT screen is displayed on the monitor. Make the print settings on the camera's monitor.  Go to "Printing pictures" (P.109).

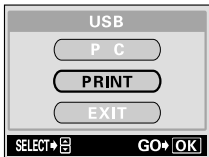

Note

- If PC is selected in step 4, the PRINT MODE SELECT screen is not displayed. If the screen is not displayed after several minutes, remove the USB cable from the camera and start again from step 1.

Printing pictures

When the camera is connected to a PictBridge-compatible printer, the PRINT MODE SELECT screen is displayed on the monitor. Use this screen to select the print mode. You can choose from the following print modes.

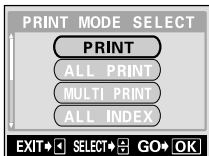

- PRINT** Prints the selected picture.
☞ "PRINT mode/MULTI PRINT mode" (P.111)
- ALL PRINT** Prints all the pictures stored on the card.
☞ "ALL PRINT mode" (P.115)
- MULTI PRINT** Prints one picture in multiple layout format.
☞ "PRINT mode/MULTI PRINT mode" (P.111)
- ALL INDEX** Prints an index of all the pictures stored on the card.
☞ "ALL INDEX mode/PRINT ORDER mode" (P.117)
- PRINT ORDER** Prints the pictures according to the print reservation data on the card. If no print reservations (☞ P.98) have been made, this option is not available.
☞ "ALL INDEX mode/PRINT ORDER mode" (P.117)

Options for the print mode and other settings

- Available options for some settings such as the print mode and paper size may differ depending on the type of printer. For details, refer to the instruction manual of your printer.

Using the simple print method

The following is the simplest way of printing a picture. This prints one copy of the selected picture. The date or file name will not be printed.

- 1 In the PRINT MODE SELECT screen, press   to select PRINT, then press .**

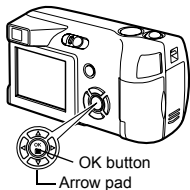

- The PRINT PAPER screen is displayed.



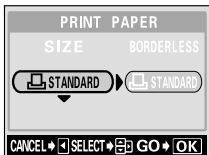

- 2 Press   to select the paper size, then press .**



- When the PRINT PAPER screen is not displayed, SIZE, BORDERLESS and PICS/SHEET are set to  STANDARD. Go to step 4.

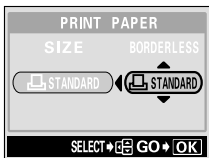

- 3 Use   to select framed or unframed, then press .**

OFF () The image is printed inside a blank frame.
ON () The image is printed filling the entire page.



- 4 Press   to select the picture you want to print, and press .**

- The PRINT screen is displayed.



5 Press to select PRINT, then press .

- Printing starts.
- To cancel printing, select CANCEL and press . The PRINT MODE SELECT screen will be displayed again.
- When printing completes, the monitor displays the PRINT PAPER screen shown in Step 4. If you want to continue printing, repeat step 4 and 5.

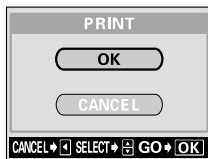

PRINT mode/MULTI PRINT mode

1 In the PRINT MODE SELECT screen, press to select PRINT or MULTI PRINT, then press .

- The PRINT PAPER screen is displayed.

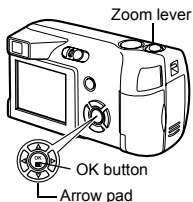



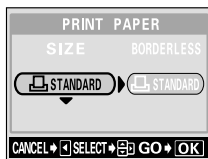

2 Press to select the paper size, then press .

- **PRINT mode:** Go to step 3.
- **MULTI PRINT mode:** Go to step 4.
- When the PRINT PAPER screen is not displayed, SIZE, BORDERLESS and PICS/SHEET are set to  STANDARD. Go to step 5.



PRINT PAPER screen

- 3 Use**   **to select framed or unframed, then press**  **.**
Go to step 5.

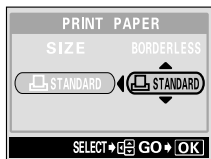

- OFF () The image is printed inside a blank frame.
- ON () The image is printed filling the entire page.

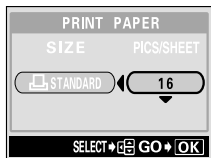

- 4 Press**   **to select PICS/SHEET, then press**  **.**

- PICS/SHEET depends on the paper size set in step 2 and the capabilities of your printer.



- 5 Press**   **to select the picture you want to print.**

- Press the zoom lever toward W to display the pictures in index format. You can then select the pictures you want to print from the index.





- 6 Select the print reservation method.**

SINGLE PRINT Makes a single-frame print reservation for the selected picture according to standard settings.

MORE Sets the number of prints of the selected picture in the print reservation data. You can also add the date or file name.

● Set a SINGLE PRINT reservation

Press .

- Press  when  is displayed to cancel the reservation.



Print reservation mark is displayed.





● Set MORE print reservations

① Press .

- Print information setting screen is displayed.

② Press   to select the item you want to set, then press .

- Press   to select the item, then press .

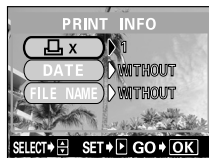

 x

Sets the number of prints. You can select up to 10 prints.

DATE ()

If you select WITH, pictures are printed with the date and time.

FILE NAME ()

If you select WITH, pictures are printed with the file name.

- DATE and FILE NAME are not available in MULTI PRINT mode.

3 When you have finished all the settings for MORE, press .

- The screen displayed in Step 5 appears.

- To print more than one picture in PRINT and/or MULTI PRINT mode, repeat Steps 5 and 6 and make single and/or multiple print reservations for all the pictures you want to print.
-  is displayed in MULTI PRINT mode.



The settings you have made are displayed.



7 Press .

- The PRINT screen is displayed.

8 Print the pictures.

- Press   to select OK or CANCEL, then press .

OK Printing starts.

CANCEL The settings are canceled and the monitor returns to the PRINT MODE SELECT screen.



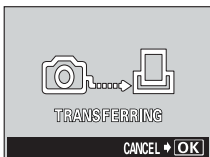
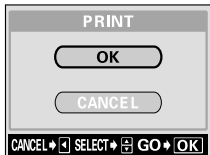

- When printing is finished, the monitor returns to the PRINT MODE SELECT screen.

 "Exiting direct printing" (P.119)



TRANSFERRING screen

● To cancel printing

Pressing  during print data transfer displays the screen for selecting whether to continue or cancel printing. To cancel printing, press   to select CANCEL, then press .

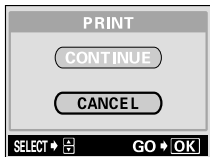

ALL PRINT mode

- 1** In the **PRINT MODE SELECT** screen, press to select **ALL PRINT**, then press .

- The PRINT PAPER screen is displayed.

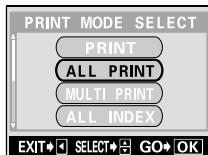

- 2** Press to select the paper size, then press .

- When the PRINT PAPER screen is not displayed, SIZE and BORDERLESS are set to STANDARD. Go to Step 4.

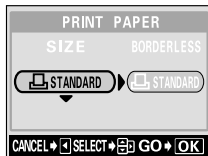

- 3** Use to select framed or unframed, then press .

OFF () The image is printed inside a blank frame.

ON () The image is printed filling the entire page.

- Print information setting screen is displayed.

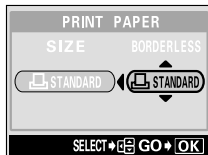

- 4** Press to select the item you want to set, then press .

- Press to select the item, then press .
- If PRINT INFO cannot be set with your printer, go to step 6.
- Only one print of each image can be made at a time.

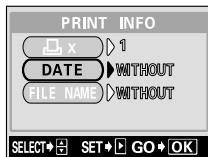



DATE () If you select WITH, pictures are printed with the date and time.

FILE NAME () If you select WITH, pictures are printed with the file name.

5 Press .

- The PRINT screen is displayed.

6 Print the pictures.

- Press   to select OK or CANCEL, then press .

OK Printing starts.

CANCEL The settings are canceled and the monitor returns to the PRINT MODE SELECT screen.



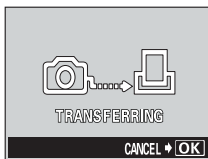
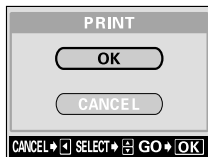

- When printing is finished, the monitor returns to the PRINT MODE SELECT screen.

 "Exiting direct printing" (P.119)



TRANSFERRING screen

● To cancel printing

Pressing  during print data transfer displays the screen for selecting whether to continue or cancel printing. To cancel printing, press   to select CANCEL, then press .

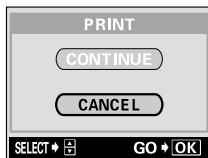

ALL INDEX mode/PRINT ORDER mode

- 1** In the **PRINT MODE SELECT** screen, press to select **ALL INDEX** or **PRINT ORDER**, then press .

- The PRINT PAPER screen is displayed.

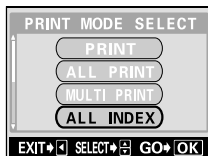

- 2** Press to select the paper size, then press .

- When the PRINT PAPER screen is not displayed, SIZE and BORDERLESS are set to STANDARD. Go to Step 4.



- 3** Use to select framed or unframed, then press .



OFF () The image is printed inside a blank frame.

ON () The image is printed filling the entire page.

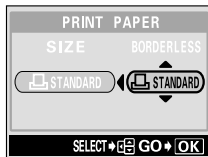
- The print screen is displayed.
- BORDERLESS is not available in ALL INDEX mode. Press and go to Step 4.



4 Print the pictures.

- Press   to select OK or CANCEL, then press .

OK Printing starts.

CANCEL The settings are canceled and the monitor returns to the PRINT MODE SELECT screen.



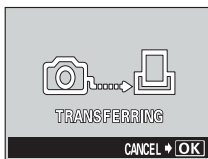
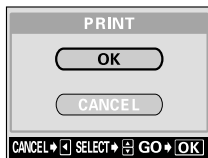

- When printing is finished, the monitor returns to the PRINT MODE SELECT screen.

 "Exiting direct printing" (P.119)



TRANSFERRING screen

● To cancel printing

Pressing  during print data transfer displays the screen for selecting whether to continue or cancel printing. To cancel printing, press   to select CANCEL, then press .

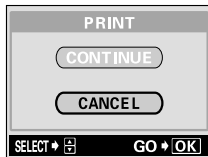

Exiting direct printing

When you have finished printing, disconnect the camera from the printer.

- 1 In the **PRINT MODE SELECT** screen, select .

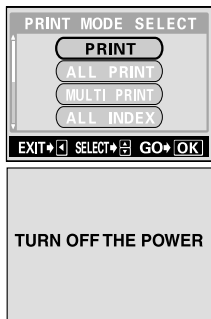

- The message is displayed.

- 2 Set the power switch at **OFF**.

- The camera turns off.

Power switch

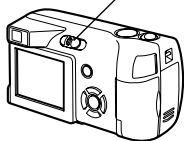

- 3 Remove the **USB cable** from the camera.

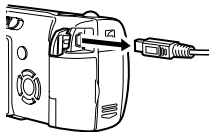



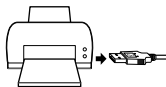

- 4 Remove the **USB cable** from the printer.



If an error code is displayed

If an error code appears on the camera's monitor during direct print setting or printing, see the following table.

For more details, refer to the printer's instruction manual.

| Monitor indication | Possible cause | Corrective action |
|--|--|---|
|  NO CONNECTION | The camera is not connected to the printer correctly. | Disconnect the camera and connect it again correctly. |
|  NO PAPER | There is no paper in the printer. | Load some paper in the printer. |
|  NO INK | The printer has run out of ink. | Replace the ink cartridge in the printer. |
|  JAMMED | The paper is jammed. | Remove the jammed paper. |
| SETTINGS CHANGED | The printer's paper cassette has been removed or the printer has been manipulated while making settings on the camera. | Do not manipulate the printer while making settings on the camera. |
|  PRINT ERROR | There is a problem with the printer and/or camera. | Turn off the camera and printer. Check the printer and remedy any problems before turning the power on again. |











TIPS

- If an error code other than those shown above is displayed, refer to  "Error codes" (P.121).

9 Miscellaneous

Error codes

| Monitor indication | Possible cause | Corrective action |
|--|---|---|
|  NO CARD | The card is not inserted, or it cannot be recognized. | Insert a card or insert a different card. If the problem persists, format the card. If the card cannot be formatted, it cannot be used. |
|  CARD ERROR | There is a problem with the card. | This card cannot be used. Insert a new card. |
|  WRITE-PROTECT | Writing to the card is prohibited. | Read-only setting is applied to the card by a PC. Cancel the setting using the PC. |
|  CARD FULL | The card is full. No more pictures can be taken or no more information such as print reservation can be recorded. | Replace the card or erase unwanted pictures. Before erasing, download important images to a PC. |
|  NO PICTURE | There are no pictures on the card. | The card contains no pictures. Record pictures. |
|  PICTURE ERROR | The selected picture has a problem, therefore it cannot be played back on this camera. | Use image processing software to view the picture on a PC. If that cannot be done, the image file is damaged. |
|  CARD-COVER OPEN | The card cover is open. | Close the card cover. |
|  | The card is not formatted. | Format the card. All data on the card is deleted. |
|  BATTERY EMPTY | The camera does not operate because the battery power runs out. | Load the new batteries. |

Troubleshooting

The camera does not work

The camera does not turn on or function buttons do not respond.

| Possible cause | Corrective action | Ref. Page |
|---|--|-----------|
| The power is off. | Turn on the camera. | P.22 |
| The batteries are loaded incorrectly. | Reload the batteries correctly. | P.15 |
| The batteries are exhausted. | Replace the batteries with new ones. | P.15 |
| The batteries are temporarily unable to function because of the cold. | Warm the batteries by putting them in your pocket for a while. | — |
| The camera is in the sleep mode. | Operate the camera (press the shutter button or the zoom lever etc.). | P.22 |
| There is condensation* inside the camera. | Wait until the camera dries before turning it on again. | — |
| The camera is connected to a PC. | Disconnect from PC. The camera will not operate while it is connected to a PC. | — |

*Condensation: When it is cold outside, the water vapor in the air is rapidly cooled and turns to droplets of water.

Condensation occurs when the camera is suddenly taken from a cold place into a warm room.



No picture is taken when the shutter button is pressed.

| Possible cause | Corrective action | Ref. Page |
|--------------------------------------|--|------------------|
| The power is off. | Turn on the camera. | P.22 |
| The flash has not finished charging. | Release your finger from the shutter button, and wait until the  mark stops blinking. Press the shutter button again. | P.56 |
| The card is full. | Erase unwanted pictures or insert a new card. Before erasing, download important images to a PC. | P.83, P.84, P.91 |
| The memory gauge is full. | Wait until there is room in the memory gauge. | P.12 |
| There is a problem with the card. | Refer to the "Error codes". | P.121 |

| The flash does not fire. | | |
|--|--|-----------|
| Possible cause | Corrective action | Ref. Page |
| The flash is set to the flash off mode. | Select a flash mode other than flash off. | P.56 |
| The subject is illuminated. | If you want the flash to fire on a brightly illuminated subject, set the flash to fill-in mode. | P.56 |
| Sequential shooting, movie mode, or super macro shooting is set. | The flash does not fire in the sequential shooting, movie mode or super macro shooting. Set  in the DRIVE mode. | P.63 |
| Panorama mode is set. | The flash does not fire in the panorama mode. Cancel the panorama mode. | P.64 |

| The monitor does not turn on. | | |
|----------------------------------|---|-----------|
| Possible cause | Corrective action | Ref. Page |
| The camera is in the sleep mode. | Operate the camera (press the shutter button or the zoom lever etc.). | P.22 |

| The monitor is hard to see. | | |
|--|---|-----------|
| Possible cause | Corrective action | Ref. Page |
| The brightness is not adjusted properly. | Select  in the mode menu and then adjust the brightness. | P.94 |
| The monitor is exposed to direct sunlight. | Block the sunlight with your hand. | — |
| Vertical lines appear on the monitor screen. | Bright light, such as direct sunlight, may cause vertical lines to appear on the monitor screen. This is not a malfunction. | — |

| Pictures you have taken do not appear on the monitor. | | |
|--|--|------------|
| Possible cause | Corrective action | Ref. Page |
| The power is off. | Set the power switch at  , to turn the monitor on. | P.23, P.73 |
| The camera is in the shooting mode. | Press QUICK VIEW button or set the power switch to  to switch to the playback mode. | P.23, P.74 |
| There are no pictures on the card. | NO PICTURE appears on the monitor. Record pictures. | – |
| There is a problem with the card. | Refer to the "Error codes". | P.121 |

| The date recorded with the image data is wrong. | | |
|--|---|------------|
| Possible cause | Corrective action | Ref. Page |
| The date/time is not set. | Set the date/time. The clock adjustment is not factory-preset. | P.27 |
| The camera has been left with the batteries removed. | If the camera is left for about 3 days with the batteries removed, the date and time setting will revert to the factory default setting. Set the date/time again. | P.16, P.27 |

| The settings are returned to the factory default settings when the camera is turned off. | | |
|---|---|-----------|
| Possible cause | Corrective action | Ref. Page |
| ALL RESET is set to ON. | Select the SETUP tab in the mode menu and set ALL RESET to OFF. | P.89 |

The image quality is poor

| The picture is too bright. | | |
|--|--|-----------|
| Possible cause | Corrective action | Ref. Page |
| The flash was set to the fill-in flash mode. | Select a flash mode other than fill-in flash. | P.56 |
| The subject was excessively illuminated. | Adjust the exposure compensation toward minus (-) or change the camera position. | P.69 |

| The picture is too dark. | | |
|---|---|-----------|
| Possible cause | Corrective action | Ref. Page |
| The flash was blocked by your finger. | Hold the camera correctly, keeping your fingers away from the flash. | P.30 |
| The subject was out of the working range of the flash. | Shoot within the flash working range. | P.56 |
| The flash was set to the flash off mode. | Select a flash mode other than flash off. | P.56 |
| The subject was too small and was backlit. | Set the flash to fill-in mode. | P.56 |
| The sequential shooting mode was used. | Higher shutter speeds are used when the sequential shooting mode is selected, which may result in pictures that are darker than usual. Select <input type="checkbox"/> in the DRIVE menu. | P.63 |
| Bright subjects such as snow will turn out darker than their natural colors in the image. | Adjust the exposure compensation toward +. | P.69 |

| The colors of pictures taken indoors look unnatural. | | |
|--|--|-----------|
| Possible cause | Corrective action | Ref. Page |
| Indoor lighting can affect the picture's colors. | Set the white balance according to the lighting. | P.71 |
| There is no white in the subject. | Include something white in the picture, or shoot using the fill-in flash mode. | P.56 |
| The white balance setting is wrong. | Adjust the white balance according to the light source. | P.71 |

| The picture has obscured edge(s). | | |
|--|---|------------------|
| Possible cause | Corrective action | Ref. Page |
| The lens was partly blocked by your finger or the strap. | Hold the camera correctly, keeping your fingers and the strap away from the lens. | P.30 |
| The subject was too close. | Check the actual picture area by using the monitor to take the picture. | P.44 |

| The picture is out of focus. | | |
|---|--|------------------|
| Possible cause | Corrective action | Ref. Page |
| The camera moved when the shutter button was pressed. | Hold the camera correctly and press the shutter button gently. Camera movement occurs easily with slower shutter speeds. When you take a picture with the flash off mode in a night scene or a dark situation, use a tripod, or hold the camera firmly. | P.30 P.56 |
| The lens was dirty. | Clean the lens. Use a commercially available blower brush and then wipe with a Lens cleaner to remove dust. Mold may form on the lens surface if the lens is left dirty. | – |
| The focus may not be correct even if the green lamp lights. | Determine the position of the subject after focusing the camera on an object about the same distance away as the subject. | P.48 |













Miscellaneous

| The life of the batteries is short. | | |
|---|--|-----------|
| Possible cause | Corrective action | Ref. Page |
| The camera is being used in a cold area. | The battery performance decreases in cold areas. Protect the camera from the cold by using a cold protection gear, or by putting it inside your clothes. | – |
| The correct battery level is not displayed. | Batteries can run out without a warning message when the amount of power consumed increases considerably. Replace with new batteries. | P.15 |

| The printer fails to connect. | | |
|--|--|-----------|
| Possible cause | Corrective action | Ref. Page |
| PC was selected on the monitor after connecting to the printer with a USB cable. | Turn the camera off and start again from step 1 of "Connecting the camera to a printer". | P.108 |
| The printer does not support PictBridge. | Refer to the printer's instruction manual or contact the manufacturer. | – |









List of menus

● Shooting mode menus (P / / / / / /)















| Top menu | Tab | Function | Setting | Ref. Page |
|---|--------|--|---|-----------|
| MODE MENU | CAMERA |  | -2.0, -1.5, -1.0, -0.5, 0, +0.5, +1.0, +1.5, +2.0 | P.69 |
| | | DIGITAL ZOOM* ¹ | ON, OFF | P.54 |
| | |  | ON, OFF | P.61 |
| | | DRIVE |  | P.63 |
| | | PANORAMA* ¹ | | P.64 |
| | | CARD SETUP | YES, NO | P.91 |
| | SETUP | ALL RESET | ON, OFF | P.89 |
| | |   | ENGLISH, FRANCAIS, DEUTSCH, ESPAÑOL, ITALIANO, РУССКИЙ, PORTUGUES | P.25 |
| | | REC VIEW | ON, OFF | P.95 |
| | | FILE NAME | RESET, AUTO | P.96 |
| | | PIXEL MAPPING | | P.97 |
| | |  | | P.94 |
| | |  | | P.27 |
| WB | | AUTO,  ,  ,  ,  | P.71 | |
|  | | SHQ, HQ, SQ1, SQ2 | P.66 | |
| MONITOR OFF (MONITOR ON) | | | P.47 | |

*¹ Cannot be selected in  mode.











● Shooting mode menus ()

| Top menu | Tab | Function | Setting | Ref. Page |
|---|------------|---|--|--|
| MODE MENU | CAMERA |  | -2.0, -1.5, -1.0, -0.5, 0, +0.5, +1.0, +1.5, +2.0 | P.69 |
| | | DIGITAL ZOOM | ON, OFF | P.54 |
| | CARD SETUP | CARD SETUP | YES, NO | P.91 |
| | | ALL RESET | ON, OFF | P.89 |
| | |  | ENGLISH, FRANCAIS, DEUTSCH, ESPAÑOL, ITALIANO, РУССКИЙ, PORTUGUES | P.25 |
| | | REC VIEW | ON, OFF | P.95 |
| | | FILE NAME | RESET, AUTO | P.96 |
| | | PIXEL MAPPING | | P.97 |
| | |  | | P.94 |
| | |  | | P.27 |
| | WB | | | AUTO,  ,  ,  ,  |
|  | | | HQ, SQ | P.66 |
| MONITOR OFF (MONITOR ON) | | | | P.47 |

● Playback mode menus (Still picture)







| Top menu | Tab | Function | Setting | Ref. Page |
|---|---|---|---|--------------|
| MODE MENU | PLAY |  | ON, OFF | P.82 |
| | |  | 0°, +90°, -90 | P.76 |
| | |  |  ,  | P.102, P.100 |
| | EDIT |  | 640x480, 320x240, CANCEL | P.85 |
| | | CARD SETUP |  ALL ERASE,  FORMAT | P.84, P.91 |
| | SETUP | ALL RESET | ON, OFF | P.89 |
| | |  | ENGLISH, FRANCAIS, DEUTSCH, ESPAÑOL, ITALIANO, РУССКИЙ, PORTUGUES | P.25 |
| | |  | | P.94 |
| | |  | | P.27 |
| |  | INFO |  | 4, 9, 16 |
|  | | | | P.79 |
|  | ERASE | | YES, NO | P.93 P.83 |

● Playback mode menus ()





| Top menu | Tab | Function | Setting | Ref. Page |
|---|----------------|---|--|--------------------------------|
| MODE MENU | PLAY |  ON, OFF | ON, OFF | P.82 |
| | EDIT |  INDEX | OK, RESET, CANCEL | P.87 |
| | CARD | CARD SETUP |  ALL ERASE, | P.84, |
| | | |  FORMAT | P.91 |
| | SETUP | ALL RESET | ON, OFF | P.89 |
| | |   | ENGLISH, FRANCAIS, DEUTSCH, ESPAÑOL, ITALIANO, РУССКИЙ, PORTUGUES | P.25 |
| | |  | | P.94 |
| | |  | | P.27 |
| | |  | 4, 9, 16 | P.78 |
| | MOVIE PLAYBACK | | | PLAYBACK, FRAME BY FRAME, EXIT |
| INFO | | | | P.93 |
|  ERASE | | | YES, NO | P.83 |

List of factory default settings



● Shooting mode

| | |
|---|---|
|  | AUTO |
|  | OFF |
|  | OFF |
| Shooting mode | P (PROGRAM AUTO) |
| Zoom | Wide |
| Monitor | ON |
|  | HQ |
|  | 0.0 |
| DRIVE |  (Single-frame shooting) |
| DIGITAL ZOOM | OFF |
| PANORAMA | OFF |
| WB | AUTO |
| FILE NAME | RESET |
|  | OFF |















● Playback mode

| | |
|---|-----|
|  | OFF |
|  | OFF |
| INFO | OFF |
|  | OFF |
|  | 0° |
|  | 9 |

● Other default settings

| | |
|---|------------|
| ALL RESET | ON |
|  | ENGLISH |
| REC VIEW | ON |
|  | ±0 |
|  | 2004.01.01 |

List of items by shooting mode

| Shooting mode Item | P |  |  |  |  |  |  |
|---|---|---|---|---|---|---|---|
|  | ✓ | ✓ | ✓ | ✓ | ✓ | ✓ | ✓ |
|  | ✓ | ✓ | ✓ | ✓ | ✓ | — | — |
|  | ✓ | ✓ | ✓ | ✓ | ✓ | ✓ | — |
|  | ✓ | ✓ | ✓ | ✓ | ✓ | ✓ | ✓ |
| Optical zoom | ✓ | ✓ | ✓ | ✓ | ✓ | W (Wide) fixed | ✓ |
|  | ✓ | ✓ | ✓ | ✓ | ✓ | ✓ | ✓* |
|  | ✓ | ✓ | ✓ | ✓ | ✓ | ✓ | ✓ |
|  | ✓ | ✓ | ✓ | ✓ | — | ✓ | — |
| DIGITAL ZOOM | ✓ | ✓ | ✓ | ✓ | ✓ | — | ✓ |
| PANORAMA | ✓ | ✓ | ✓ | ✓ | ✓ | — | — |
| WB | ✓ | ✓ | ✓ | ✓ | ✓ | ✓ | ✓ |
| CARD SETUP | ✓ | ✓ | ✓ | ✓ | ✓ | ✓ | ✓ |
| ALL RESET | ✓ | ✓ | ✓ | ✓ | ✓ | ✓ | ✓ |
| REC VIEW | ✓ | ✓ | ✓ | ✓ | ✓ | ✓ | ✓ |
| FILE NAME | ✓ | ✓ | ✓ | ✓ | ✓ | ✓ | ✓ |
|  | ✓ | ✓ | ✓ | ✓ | ✓ | ✓ | ✓ |
|  | ✓ | ✓ | ✓ | ✓ | ✓ | ✓ | ✓ |

* In the movie record mode, only HQ/SQ can be selected.

Camera maintenance

● After use

Turn the camera off.

● Cleaning the camera

- 1 Slide the power switch to OFF to turn the camera off.**
Make sure that the monitor is turned off.
- 2 Remove the batteries (👉 P.15). (If you are using an AC adapter, unplug the AC adapter from the camera first before removing the plug from the AC outlet.)**
- 3 Exterior:**
→ Wipe gently with a soft cloth. If the camera is very dirty, soak the cloth in mild soapy water and wring well. Wipe the camera with the damp cloth and then dry it with a dry cloth. If you have used the camera at the beach, use a cloth soaked in clean water and well wrung.
Monitor and viewfinder:
→ Wipe gently with a soft cloth.
Lens:
→ Blow dust off the lens with a commercially available blower, and wipe gently with a commercially available lens cleaning paper.
Card:
→ Wipe gently with a soft, dry cloth.

● Storage

- When storing the camera for extended periods, remove the batteries and card from the camera, and keep it in a cool, dry place that is ventilated well.
- Periodically, replace the batteries, and test camera functions.



Note

- Do not use strong solvents such as benzene or alcohol, or chemically treated cloth.
- Cleaning should be done only after the batteries have been removed or the AC adapter has been disconnected.
- Mold may form on the lens surface if the lens is left dirty.
- Avoid leaving the camera in places where chemical products are handled since this may result in corrosion.

Specifications

| | |
|---------------------------|--|
| Product type | : Digital camera (for shooting and displaying) |
| Recording system | |
| Still picture | : Digital recording, JPEG (in accordance with Design rule for Camera File system (DCF)) |
| Applicable standards | : Exif 2.2, Digital Print Order Format (DPOF), PRINT Image Matching II, PictBridge |
| Movie | : QuickTime Motion JPEG support |
| Memory | : xD-Picture Card (16 – 512 MB) |
| No. of storable pictures | |
| When a 16 MB card is used | : Approx. 6 frames (SHQ : 2048 x 1536) Approx. 20 frames (HQ : 2048 x 1536) Approx. 32 frames (SQ1 : 1600 x 1200) Approx. 165 frames (SQ2 : 640 x 480) |
| No. of effective pixels | : 3,200,000 pixels |
| Image pickup device | : 1/2.7" CCD solid-state image pickup, 3,340,000 pixels (gross) |
| Lens | : Olympus lens 5.8 mm to 17.4 mm, f2.9 to 5.0, 7 elements in 6 groups (equivalent to 38 mm to 114 mm lens on 35 mm camera) |
| Photometric system | : Digital ESP metering |
| Shutter speed | : 1 to 1/2000 sec. (NIGHT SCENE mode: 2 sec) |
| Shooting range | : 0.5 m (1.6 ft.) to ∞ (W), 0.9 m (3.0 ft.) to ∞ (T) (normal) 0.2 m (0.7 ft.) to 0.5m (1.6 ft.) (W), 0.5 m (1.6 ft.) to 0.9 m (3.0 ft.)(T) (macro mode) |
| Viewfinder | : Optical real image viewfinder |
| Monitor | : 1.8" TFT color LCD display, 85,000 pixels |
| Outer connector | : DC-IN jack, USB connector (mini-B) |
| Automatic calendar system | : 2000 up to 2099 |

Specifications

Operating environment

| | |
|--------------|---|
| Temperature | : 0°C to 40°C (32°F to 104°F) (operation) -20°C to 60°C (-4°F to 140°F) (storage) |
| Humidity | : 30% to 90% (operation)/10% to 90% (storage) |
| Power supply | : 1 CR-V3 lithium battery pack, or 2 AA (R6) alkaline batteries or NiMH batteries. AC adapter (optional) Manganese (zinc-carbon) batteries cannot be used. |
| Dimensions | : 102 mm (W) x 55.5 mm (H) x 36.5 mm (D) (4" x 2.2" x 1.4") (excluding protrusions) |
| Weight | : 150 g (0.3 lb) (without batteries or card) |

SPECIFICATIONS ARE SUBJECT TO CHANGE WITHOUT ANY NOTICE OR OBLIGATION ON THE PART OF THE MANUFACTURER.

Glossary of terms

CCD (Charge-Coupled Device)

This converts light passing through the lens into electrical signals. On this camera, light is picked up and converted into RGB signals to build a single image.

DCF (Design rule for Camera File system)

A standard for image files by the Japan Electronics and Information Technology Industries Association (JEITA).

Digital ESP (Electro-Selective Pattern) Light Metering

This determines the exposure by metering and calculating the light levels in the center and other areas of the image separately.

DPOF (Digital Print Order Format)

This is for saving desired print settings on digital cameras. By entering which images to print and the number of copies of each, the user can easily have the desired images printed by a printer or print lab that supports the DPOF format.

Exposure

The amount of light used to capture an image. The exposure is determined by the time the shutter is open (shutter speed) and the amount of light that passes through the lens (aperture).

JPEG (Joint Photographic Experts Group)

A compression format for color still images. Photographs (images) shot using this camera are recorded onto the card in JPEG format when the Record mode is set to SHQ, HQ or SQ. By downloading these images to a personal computer, users can edit them using graphics application software or view the images using an Internet web browser.

PictBridge

It is the standard for connecting digital cameras and printers of different makers and printing out pictures directly.

Pixels

A pixel is the smallest unit (dot) used to make up an image. Clear large-sized printed images require millions of pixels.

Resolution

The size of the picture expressed as the number of dots (pixels) that make up the image. For instance, a picture taken in 640 x 480 resolution is the same size as the PC screen when the monitor setting is 640 x 480. However, if the monitor setting is 1024 x 768, the picture only takes up part of the screen.

Sleep Mode



A mode designed to save battery life. The camera automatically enters the sleep mode if you do not operate it for a certain time. To get out of the sleep mode, use any button on the camera (shutter button, arrow pad, etc.).

TFT (Thin-Film Transistor) Color Monitor

A color monitor constructed using thin-film transistor technology.

Index



A

- AC adapter 17
- Adjusting the monitor brightness
 94
- AF target mark. 10,44,48
- Alkaline batteries 17
- ALL RESET 89
- All-frame erase  84
- All-frame reservation  100
- Arrow pad 9,73
- Auto focus 50
- Auto-flash 57

B

- Batteries 15
- Battery check. 12
- Battery compartment cover . . . 9,15

C

- Camera movement warning 10
- Card. 19
- Card check 24
- Card cover. 8,20
- CARD SETUP  91
- Close-up playback  75
- Contact area 19

D





- DC-IN jack 8,17
- DC-IN jack cover 8,17
- Digital zoom. 54
- Direct Printing 107
- DPOF 98
- DRIVE  63

E

- Elapsed time 11
- Erasing pictures  83

- Exposure compensation  69

F

- FILE NAME. 96
- File number. 11
- Fill-in flash  58
- Flash 8,56
- Flash charge 10,44
- Flash mode 10,56
- Flash mode button () 9,56
- Flash off  58
- Flash standby 10,44
- Fluorescent  71
- Focus Lock 48
- Format 91

G

- Green lamp. 44





H

- HQ 66

I



























- INDEX. 87
- Index area. 19
- Index display  77
- INFO 93

L

- Landscape  41
- Landscape + Portrait  41
- Language   25
- Lens 8
- Lithium battery pack 17
- Lock button 9,22,40

M

- Macro button () 9,59

- Macro mode  10,59
- Memory gauge 10,12,44
- Mode Menus 31,32,36
- Monitor 9,10,44
- MONITOR OFF 47
- MONITOR ON 47
- Movie  42,51
- MOVIE PLAYBACK  80
- N**
- Night scene  42
- NiMH batteries 17
- Number of storable still pictures
..... 10,66
- O**
- OK/Menu button () 9,31
- Optical zoom 53
- Overcast  71
- P**
- PANORAMA 64
- PictBridge 107
- Picture rotation  76
- PIXEL MAPPING 97
- Playback mode 11,23
- Portrait  41
- Power switch 9,23,40,73
- Pressing fully 45
- Pressing halfway 45
- Print setting  98
- PROGRAM AUTO **P** 41
- Protect  82
- Q**
- QUICK VIEW 74
- QUICK VIEW button 9,74
- R**
- REC VIEW 95
- Rechargeable batteries 17
- Record mode  66
- Red-eye reduction flash  57
- Remaining power level 12
- Remaining recording time 10,51
- Resetting print reservation data 
..... 105
- Resizing  85
- Resolution 66
- S**
- Self portrait  42
- Self-timer  62
- Self-timer button () 9,62
- Self-timer lamp 8,62
- Sequential shooting  63
- Setting the date and time  27
- Shooting mode 10,22,40
- Shooting mode button () 9,40
- Shortcut Menus 31,34
- SHQ 66
- Shutter button 8,45
- Single-frame erase  83
- Single-frame playback  73
- Single-frame reservation  102
- Sleep mode 22
- Slideshow  79
- SQ 66
- Strap 14
- Strap eyelet 8,14
- Sunlight  71
- Super macro mode  61
- T**
- Top menu 32
- Total recording time 11,66
- Tripod socket 9
- Tungsten  71

U

USB connector 8,108

USB connector cover 8,108

V

Viewfinder 9,44

Virtual dial 40

WWhite balance **WB** 71**X**

xD-Picture Card 19

Z

Zoom lever 8,53,75,77

OLYMPUS®

<http://www.olympus.com/>

OLYMPUS CORPORATION

Shinjuku Monolith, 3-1 Nishi-Shinjuku 2-chome, Shinjuku-ku, Tokyo, Japan

OLYMPUS AMERICA INC.

Two Corporate Center Drive, Melville, NY 11747-3157, U.S.A. Tel. 631-844-5000

Technical Support (USA)

24/7 online automated help: <http://www.olympusamerica.com/support>

Phone customer support: Tel. 1-888-553-4448 (Toll-free)

Our phone customer support is available from 8 am to 10 pm
(Monday to Friday) ET

E-Mail: distec@olympus.com

Olympus software updates can be obtained at: <http://www.olympus.com/digital>

Olympus Europa GmbH

Premises/Goods delivery: Wendenstrasse 14-18, 20097 Hamburg, Germany

Tel: +49 40-23 77 3-0 / Fax: +49 40-23 07 61

Letters: Postfach 10 49 08, 20034 Hamburg, Germany

European Technical Customer Support:

Please visit our homepage <http://www.olympus-europa.com>

or call our TOLL FREE NUMBER* : **00800 - 67 10 83 00**

for Austria, Belgium, Denmark, Finland, France, Germany, Italy, Luxemburg,
Netherlands, Norway, Portugal, Spain, Sweden, Switzerland, United Kingdom

* Please note some (mobile) phone services/provider do not permit access or
request an additional prefix to +800 numbers.

For all not listed European Countries and in case that you can't get connected to
the above mentioned number please make use of the following

CHARGED NUMBERS: **+49 180 5 - 67 10 83** or **+49 40 - 237 73 899**

Our Technical Customer Support is available from 9 am to 6 pm MET (Monday to Friday)

CAMEDIA

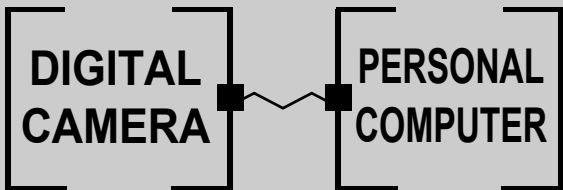

DIGITAL CAMERA — PC CONNECTION
OPERATION MANUAL

How to use your PC to get the most from images taken with your digital camera.

- Thank you for purchasing an Olympus digital camera.
- This manual provides instructions on how to install the USB driver. To ensure correct installation, refer only to these installation procedures.

Introduction

This manual explains in detail how to connect your Olympus digital camera to a computer. Read it carefully and keep it in a safe place for future reference.

About this manual

- The information contained in this manual may be subject to change without notice. For the latest information on the product, please consult your local Olympus representative.
- The information contained in this manual has been compiled by taking all possible measures to ensure its accuracy. However, if you find any errors or incomplete information, please contact your local Olympus representative.
- It is prohibited by copyright laws to duplicate in part or in whole the information contained in this manual, except for personal use. Reproduction without permission of the copyright owner is prohibited.
- The PC screens shown in this manual may differ slightly from the actual displays on some PC models.

Trademarks

- Microsoft and Windows are registered trademarks of Microsoft Corporation.
- Macintosh is a trademark of Apple Computer Inc.
- All other company and product names are registered trademarks and/or trademarks of their respective owners.

INDEX

Flowchart 4

Identifying the OS 6

Windows (98/Me/2000/XP) 8

Windows

Macintosh (OS 9/X). 23

Macintosh

**Downloading image files using other OS
(For other OS users). 31**

Flowchart

By connecting the camera to a computer with the provided USB cable, images on a card can be transferred to the computer. Some OS's (operating systems) may need a special setup before connecting to the camera for the first time. Follow the chart below.

For details, see the Olympus Corporate Site or phone customer support.

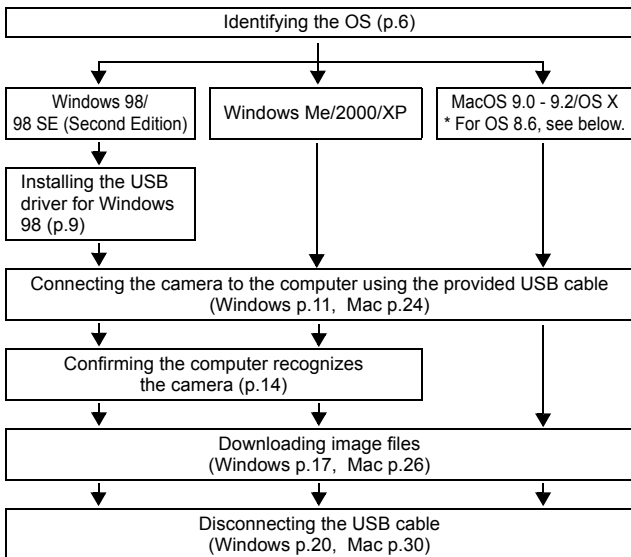

* Even if your computer has a USB connector, data transfer may not function correctly if you are using one of the operating systems listed below or if you have an add-on USB connector (extension card, etc.).

- Windows 95/NT 4.0
- Windows 98/98 SE upgrade from Windows 95
- Mac OS 8.6 or lower (except Mac OS 8.6 equipped with USB MASS Storage Support 1.3.5 installed at the factory)
- Data transfer is not guaranteed on a home-built PC system or PCs with no factory installed OS.



- When connecting the camera to the computer, make sure that there is sufficient remaining battery power. When connected (transmitting) to the computer, the camera does not enter the sleep mode nor will the camera's power turn off automatically. Depending on the camera model, when the battery power runs out or the internal temperature rises, the camera may stop operating automatically. This could cause the computer to malfunction, and any image data (file) being transmitted may be lost. Be careful when downloading files for a long period of time. Use the AC adapter (optional) when downloading files.
- If you connect or disconnect the AC adapter when the camera is connected to the computer and is running on battery power, it may result in the loss of image data on the card or cause a malfunction in the computer. Before connecting or disconnecting the AC adapter, disconnect the camera from the computer and make sure that the camera is turned off.
- To avoid computer malfunctions, do not turn off the camera when the camera is connected to a computer.
- If the camera is connected to the computer via a USB hub, operation may not be stable if there are any compatibility problems between the computer and the hub. In such cases, do not use the hub and connect the camera directly to the computer.



- You can view images using: graphics applications that support the JPEG file format (Paint Shop Pro, Photoshop, etc.); Internet browsers (Netscape Communicator, Microsoft Internet Explorer, etc.); CAMEDIA Master software; or other software. For details on using commercial graphics applications, refer to their instruction manuals.
- QuickTime is needed for playing back movies. QuickTime is included on the provided software CD.
- If you want to process images, make sure to download them to your computer first. Depending on the software, image files may be destroyed if the images are processed (rotated, etc.) while they are on the card.

Identifying the OS

Identify the OS on your computer before connecting the camera. How to identify the OS depends on the computer.

● Windows

- 1** Double-click the “My Computer” icon on your desktop.

When the “My computer” icon is not on your desktop, click “Control Panel” from the “Start” menu.

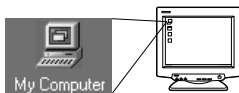

- 2** Double-click the “Control Panel” icon.



- 3** Double-click the “System” icon.



The way the file icons inside the folder appear may vary depending on your version of Windows. If you don't see the icon you are looking for, click on “view all Control Panel options” on the left of the window.

4 A System Properties window will appear. Note and record the “System:” information.

Confirm that your system is Windows 98, 98 SE, Me, 2000 Professional or Windows XP, then press “OK” to close the window.



If your OS is Windows 98/98 SE, proceed to “Installing the USB driver for Windows 98” (👉 p.9).

Users running Windows Me/2000/XP 👉 p.11

Users running other OS 👉 p.31

● Mac OS (Macintosh)

Select “About This Computer” from the Apple menu on the menu bar.

A window appears with the name of the computer’s OS.

Confirm that the OS is OS 9.0-9.2 or OS X.

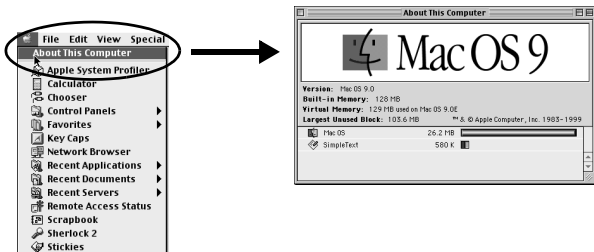

Users running Mac OS 9/X 👉 p.23

Users running other OS 👉 p.31

Windows

Using Windows 98/Me/2000/XP

Make sure that:

- Your computer is turned on and Windows is running.
- If you are running any applications, quit them all.
- You are recommended to power the camera using the optional AC adapter. If the battery power runs out while the computer is accessing the card in the camera, the camera will turn off in the middle of the operation and this could destroy image files (data). If you are using batteries, make sure that there is sufficient remaining battery power.

| | |
|---|-----------|
| Installing the USB driver for Windows 98 (When using Windows 98/98 SE) | 9 |
| Connecting the camera to the computer | 11 |
| Confirming the computer recognizes the camera | 14 |
| Confirming the USB driver is installed | 15 |
| Downloading images to your computer..... | 17 |
| Disconnecting the camera from your computer | 20 |

Installing the USB driver for Windows 98 (When using Windows 98/98 SE)

If your OS is Windows 98/98 SE, you must install the USB driver. Follow the instructions below to install the USB driver in your computer. Once it is fully installed, you do not need to repeat the procedure again.

If your OS is Windows Me/2000/XP, you do not need to install the USB driver. Proceed to “Connecting the camera to the computer” (👉 p.11).

- 1** Insert the provided software CD into your CD-ROM drive.

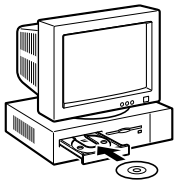

- 2** The Olympus Windows Installer should automatically launch. Click “USB Driver”.

If the USB driver is already installed in your computer, this option will not appear.

- This option will not appear if you are using Windows Me/2000/XP.



If the installer is not automatically launched, select “Run..” on the “Start” menu and then execute “(drive letter):/ Information.exe”.



The drive letter of the CD-ROM varies depending on the computer.
To identify the drive letter, double-click “My Computer” on the desktop.

- 3** Click “Continue”. The installation of the USB driver will start.



- 4** Click “OK” to restart your computer and the installation is complete.

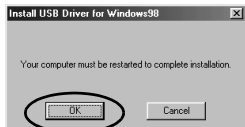

- 5** When the computer has restarted, installation is complete. If the Olympus Windows Installer screen appears, click “Close” and remove the CD-ROM from the CD-ROM drive.

Connecting the camera to the computer

Users running Windows 98/98SE need to install the USB drive before connecting the camera to your computer for the first time. (☞ p.9)

- 1** Some camera models have a “USB” setting in the menu. Make sure that “PC” is selected before connecting. This is not required if your camera does not have this setting. For details on how to operate the menu, refer to your camera's reference manual.

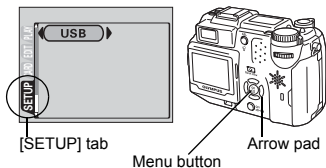

- 2** Insert the marked end of the provided USB cable into the USB port on your computer as shown below.

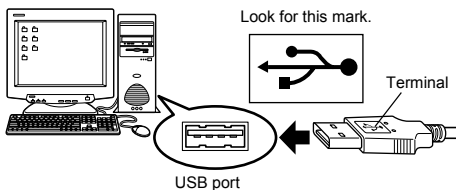



The location of the USB port varies depending on the computer. For details, refer to your computer's manual.

- 3** After making sure that the camera is turned off, connect the end of the USB cable to the USB connector on the camera.

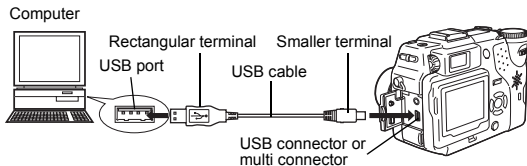
The location of the USB connector or multi connector varies depending on the camera model. Refer to the camera manual for details.



4 Turn the camera on in  (playback) mode.

- Most cameras with a lens barrier turn on automatically in Step 3, with the exception of some models which require you to press the  (monitor) button or  button.

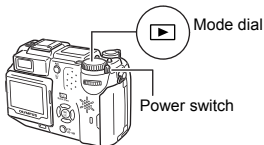
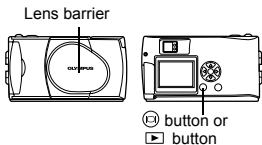

5 When the screen shown right appears on the monitor in Step 4, use the arrow pad to select “PC” and press the OK button.

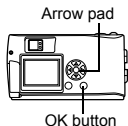
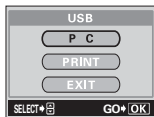

6 The computer recognizes the camera as a new device.

- Depending on the camera model, when you connect the camera to the computer, the lamp on the right of the viewfinder or the self-timer lamp may light.

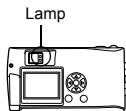

When you connect the camera to the computer for the first time, the computer automatically recognizes the camera. Click “OK” when the message saying that the installation is completed appears. The computer recognizes the camera as a “Removable Disk”.

● **Windows XP**

You can download image files from the camera easily. Select “Copy pictures to folder on my computer using Microsoft Scanner and Camera Wizard”, then follow the on-screen instructions. You may also select “take no action” to bypass the Microsoft Scanner and Camera Wizard. You may then use a more advanced image viewing/editing program such as Olympus CAMEDIA Master software. For detailed instructions on downloading, refer to the CAMEDIA Master software user’s guide.



Caution

When the camera is connected to the computer, none of the camera buttons are functional.

Confirming the USB driver is installed

If the computer does not recognize the camera as a Removable Disk, follow the procedure below to check whether the USB driver has been fully installed.

- 1** Open “My Computer” and double-click the “Control Panel” icon.
For users running Windows XP, open “Control Panel” from the “Start” menu.



- 2** Double-click the “System” icon.

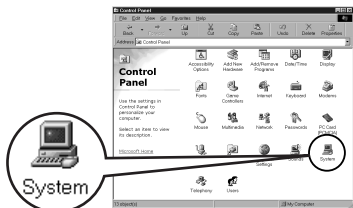

- 3** The System window will appear. Click the “Device Manager” tab.

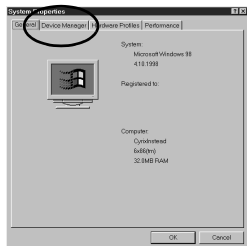

4 Confirm that “OLYMPUS Digital Camera” is in the “Universal Serial Bus Controller” category.

If you cannot find the “OLYMPUS Digital Camera”, turn the camera off, disconnect the camera from the computer and start again.

Users running Windows 98/98 SE start again from “Confirming the USB driver is installed”, and Users running Windows Me/2000/XP start from “Connecting the camera to the computer”.

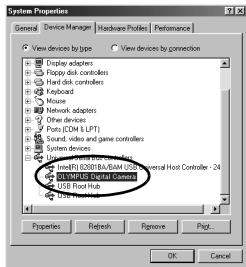

If the USB driver was successfully installed, you can find the following in the “Device Manager”.

- the name of the camera you have connected listed under “Disk drives”
- “OLYMPUS Digital Camera” listed as one of the items in the “Universal Serial Bus Controller” category

Downloading images to your computer

1 Double-click the “My Computer” icon on the desktop.

For users running Windows XP, click “Control Panel” from the “Start” menu.

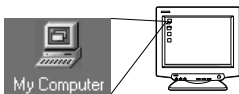

2 Double-click the “Removable Disk” icon.

A new “Removable Disk” icon appears when the camera is connected to the computer, as the digital camera is recognized as a “Removable Disk”.

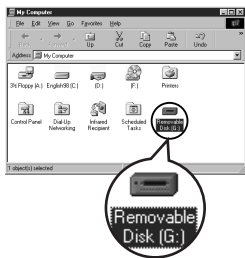

If an error message appears when you double-click the icon, there may be a problem with one of the following:

- 1 the camera's power source (the AC adapter is not properly connected or the battery power is low)

Make sure that the AC adapter is correctly connected or that the batteries are not running low.

- 2 the card (there is no card in the camera or there is a problem with the card)

Check that you can play back pictures stored on the card on the monitor of your digital camera.

3 Double-click the “Dcim” folder.

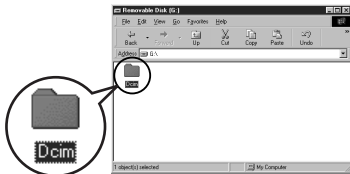

4 Double-click the “100olymp” folder.

Image files (JPEG files) with file names such as “P1010001.jpg” are displayed.

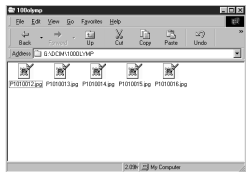

- The camera automatically assigns folder names and file names according to the following rules.

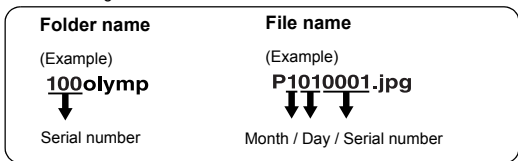

- Serial numbers of image files run from 0001 to 9999.
- Serial numbers of folders run from 100 to 999.
- When file number 9999 is reached, a new folder is created and assigned the next number.
- Months January through September are expressed by the numbers 1 through 9, October by the letter A, November by B and December by C.

5 Double-click the “My Documents” icon on the desktop.

If you cannot find the icon on the desktop, select “Explorer” on the Start menu and double-click the “My Documents” icon.

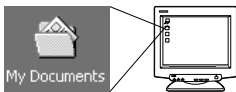

The “My Documents” window is displayed.



6 Drag & drop the image you want to save in the computer (in this case, P1010012.jpg) to the “My Documents” window.

The image is saved in the computer (in My Documents folder).

- To select all files, choose Edit > Select all.

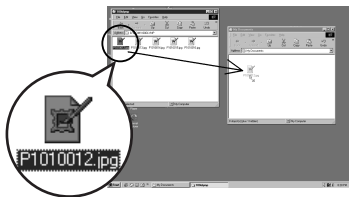

Note

When the image file has been downloaded to the computer, you can view images by double-clicking the image files downloaded to your computer. The files will be opened in the default image viewer of the operating system. If you want to view the image a different size or process it, you will need to open the image with software that supports JPEG or TIFF images files, such as Paint Shop Pro, Photoshop or CAMEDIA Master software.



Caution

The lamp on the right of the viewfinder or the card access lamp blinks while the image is being copied. Never open the card cover on the camera, load or remove the batteries, or connect or disconnect the AC adapter while the lamp is blinking as the image files may be destroyed.

Disconnecting the camera from your computer

If your OS is Windows Me/2000, proceed to “Windows Me/2000/XP” (p.21).

● Windows 98

- 1** Make sure that the lamp on the right of the viewfinder or the self-timer lamp (which on some models light while the camera is connected to the computer) or the card access lamp is not blinking. The lamps and their location vary depending on the model. Refer to your camera's reference manual.

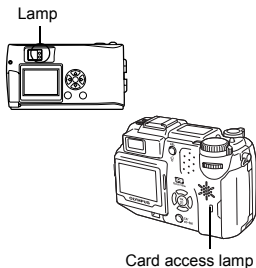

- 2** Double-click the “My Computer” icon and right-click the “Removable Disk” to display the menu.



- 3** Click “Eject” on the menu.



- 4** Make sure that the lamp on the right of the viewfinder or the self-timer lamp (which on some models light while the camera is connected to the computer) or the card access lamp is not blinking.

Depending on the camera model, the green lamp may light or lamps that were lit while the camera was connected to the computer may go off. If the lamp is not flashing, then the cable can be removed.

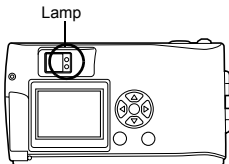

- 5** Remove the USB cable from the camera.

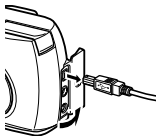

- 6** Remove the USB cable from your computer.

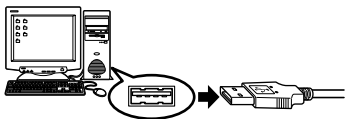

● Windows Me/2000/XP

- 1** Make sure that the lamp on the right of the viewfinder or the self-timer lamp (which on some models light while the camera is connected to the computer) or the card access lamp is not blinking.

The lamps and their location vary depending on the model. Refer to your camera's reference manual.

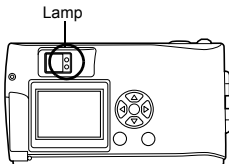

- 2** Click the  “Unplug or Eject Hardware” icon on the task bar.

The message saying that the drive has been stopped appears.

- 3** Click on the message.

The “Unplug or Eject Hardware” window appears.

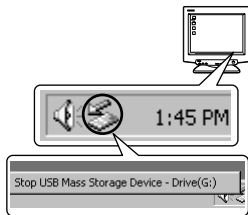

- 4** When a message appears, click “OK”.



- 5** Remove the USB cable from the camera.

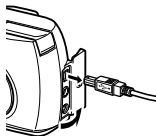

- 6** Remove the USB cable from your computer.

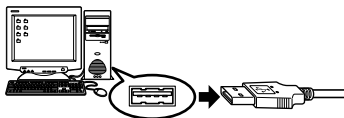

Caution

If the window returns the following message when you click “Unplug or Eject Hardware”, first make sure that no image data is being downloaded from the camera, and then remove the USB cable.



Macintosh

Using Mac OS (9/X)

Make sure that:

- Your computer is turned on and Mac OS is running.
- If you are running any applications, quit them all.
- You are recommended to power the camera using the optional AC adapter. If the battery power runs out while the computer is accessing the card in the camera, the camera will turn off in the middle of the operation and this could destroy image files (data). If you are using batteries, make sure that there is sufficient remaining battery power.

If you are running Mac OS X, the connection to the computer and downloading the image data are verified. Restrictions such as the following may occur due to the OS.

- The image file properties are not displayed correctly.
- Images in the camera cannot be opened without first downloading them. etc.

For more details, visit the Olympus web site.

| | |
|--|-----------|
| Connecting the camera to the computer | 24 |
| Downloading images to your computer..... | 26 |
| Disconnecting the camera from your computer | 30 |

Connecting the camera to the computer

- 1** Some camera models have a “USB” setting in the menu. Make sure that “PC” is selected before connecting. This is not required if your camera does not have this setting. For details on how to operate the menu, refer to your camera's reference manual.

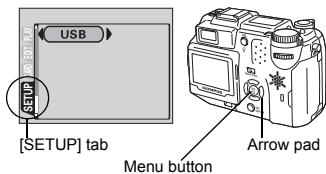

- 2** Insert the marked end of the USB cable into the USB port on your computer as shown below.

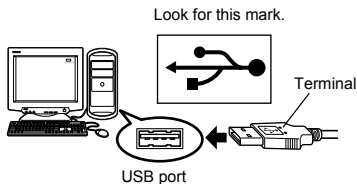

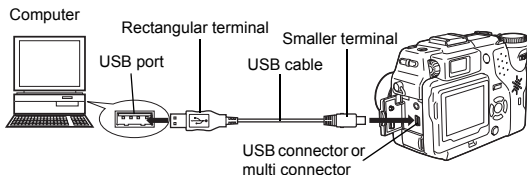

The location of the USB port varies depending on the computer. For details, refer to your computer's manual.

- 3** After making sure that the camera is turned off, connect the end of the USB cable to the USB connector on the camera.
- The location of the USB connector or multi connector varies depending on the camera model. Refer to the camera manual for details.



4 Turn the camera on in (playback) mode.

- Most cameras with a lens barrier turn on automatically in Step 3, with the exception of some models which require you to press the  (monitor) button or  button.

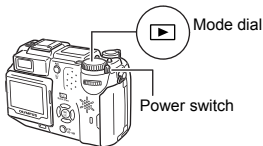
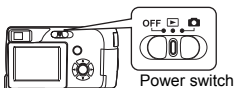
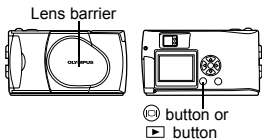

5 When the screen shown right appears on the monitor in Step 4, use the arrow pad to select "PC" and press the OK button.

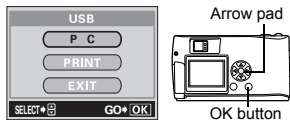

6 The computer recognizes the camera as a new device.

- Depending on the camera model, when you connect the camera to the computer, the lamp on the right of the viewfinder or the self-timer lamp may light.

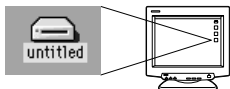

The computer recognizes the camera automatically and an "Untitled" icon appears on the desktop. If you cannot find this icon, turn off the camera and connect again.

• Mac OS X

When the computer has recognized the camera, the Apple Image Capture software automatically launches.  p.29



When the camera is connected to the computer, none of the camera buttons are functional.

Downloading images to your computer

● Mac OS 9

You can download images from the camera and save them in your computer (in this case, in the Hard Disk).

- 1** Double-click the “Untitled” icon displayed on the desktop when the camera is connected to the computer.

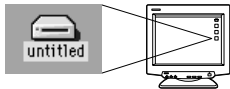

If you cannot find this icon, or if an error message appears when you double-click the icon, there may be a problem with one of the following:

- ① the camera's power source (the AC adapter is not properly connected or the battery power is low)
- ② the card (there is no card in the camera or there is a problem with the card)
Check that you can play back pictures on the monitor of your camera.
- ③ the USB cable (the camera is not properly connected to the computer by the USB cable).
- ④ Apple “File Exchange” extension is not enabled.
 - Please refer to your Apple operating system manual for instructions on how to enable this extension.

- 2** Double-click the “Dcim” folder.

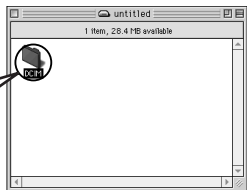

- 3** Double-click the “100OLYMP” folder.

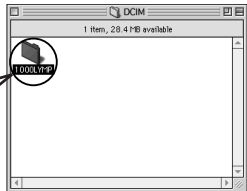
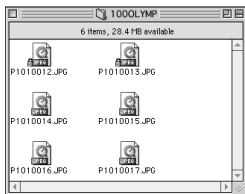
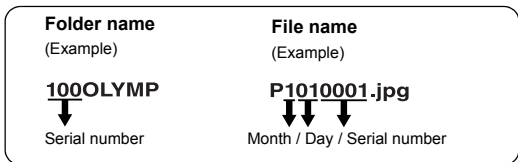

Image files (JPEG files) with file names such as "P1010001.JPG" are displayed.



- The camera automatically assigns folder names and file names according to the following rules.



- Serial numbers of image files run from 0001 to 9999.
- Serial numbers of folders run from 100 to 999.
- When file number 9999 is reached, a new folder is created and assigned the next number.
- Months January through September are expressed by the numbers 1 through 9, October by the letter A, November by B and December by C.

Macintosh

4 Double-click the "Macintosh HD" icon on the desktop.

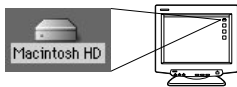

The “Hard Disk” window is displayed.

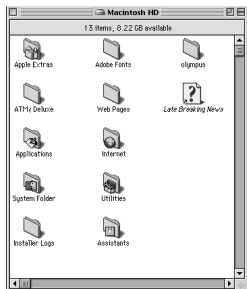

5 Drag & drop the image you want to save in the computer (in this case, P1010012.JPG) to the “Hard Disk” window.

The image is saved in the computer (in the Hard disk).

- To select all images, click Edit > Select all.

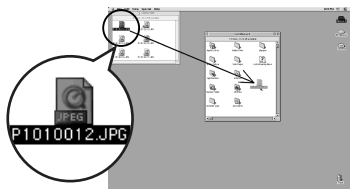

When the image file has been copied to the computer, you can view images by double-clicking the image files in the “Hard Disk” folder. The files will be opened in the default image viewer of the operating system. If you want to view the image a different size or process it, you will need to open the image with software that supports JPEG or TIFF images files, such as Paint Shop Pro, Photoshop or CAMEDIA Master software.



The lamp on the right of the viewfinder or the card access lamp blinks while the image is being copied. Never open the card cover on the camera, load or remove the batteries, or connect or disconnect the AC adapter while the lamp is blinking as the image files may be destroyed.

● Mac OS X

Malfuncions such as the following may occur due to the OS.

- If the camera is not connected correctly, a malfunction occurs in the computer.
- Date and time information of image files is not accurately displayed.
- If the card cover of the camera is opened while connecting to the computer, the “untitled” icon does not disappear from the desktop, etc.

When the computer has recognized the camera, the Apple Image Capture software dialog appears.

1 From the “Download To” menu, select a destination folder.

2 To download all images, click “Download All”.
To selectively download images, click “Download Some” and highlight the desired images.



The images are transferred from the camera to your computer.



If you are operating Mac OS X and you want to download images using the same procedure as for Mac OS 9, select “File > Close” and exit the Apple Image Capture software. At this time, the camera is indicated as “unlabeled”.



If you use the Apple Image Capture software, images downloaded to your computer and transferred back to a card may not play back on the camera or may have other problems.

Disconnecting the camera from your computer

- 1** Make sure that the lamp on the right of the viewfinder or the self-timer lamp (which on some models light while the camera is connected to the computer) or the card access lamp is not blinking.

The lamps and their location vary depending on the model. Refer to your camera's reference manual.

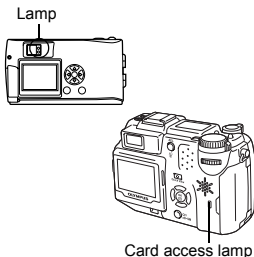

- 2** Drag the "untitled" icon on the desktop to "Trash".



- 3** Make sure that the lamp on the right of the viewfinder or the self-timer lamp (which on some models light while the camera is connected to the computer) or the card access lamp is not blinking.

Depending on the camera model, the green lamp may light or lamps that were lit while the camera was connected to the computer may go off. If the lamp is not flashing, then the cable can be removed.

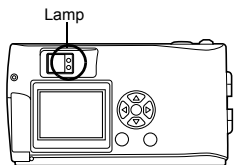

- 4** Remove the USB cable from the camera.

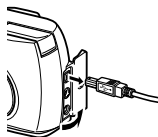

- 5** Remove the USB cable from your computer.

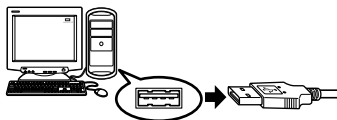

Downloading image files using other OS

(For other OS users)

Users running other OS cannot connect the camera directly to a computer.

- **Windows 95**
- **Windows NT**
- **Mac OS before OS 9**

For an OS listed above, you can download images directly to your computer using an optional floppy disk adapter or PC card adapter.

For details, see the Olympus Corporate Site or phone customer support.

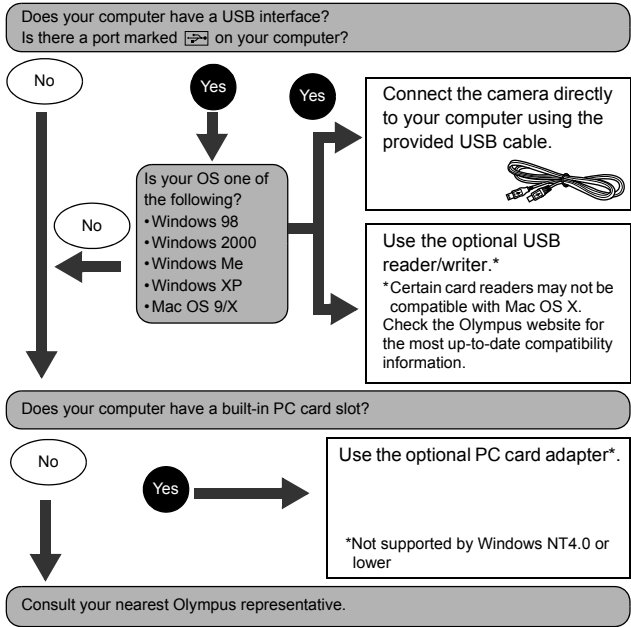

OLYMPUS®

<http://www.olympus.com/>

OLYMPUS CORPORATION

Shinjuku Monolith, 3-1 Nishi-Shinjuku 2-chome, Shinjuku-ku, Tokyo, Japan

OLYMPUS AMERICA INC.

Two Corporate Center Drive, Melville, NY 11747-3157, U.S.A. Tel. 631-844-5000

Technical Support (USA)

24/7 online automated help: <http://www.olympusamerica.com/support>

Phone customer support: Tel. 1-888-553-4448 (Toll-free)

Our phone customer support is available from 8 am to 10 pm
(Monday to Friday) ET

E-Mail: distec@olympus.com

Olympus software updates can be obtained at: <http://www.olympus.com/digital>

Olympus Europa GmbH

Premises/Goods delivery: Wendenstrasse 14-18, 20097 Hamburg, Germany

Tel: +49 40-23 77 3-0 / Fax: +49 40-23 07 61

Letters: Postfach 10 49 08, 20034 Hamburg, Germany

European Technical Customer Support:

Please visit our homepage <http://www.olympus-europa.com>

or call our TOLL FREE NUMBER* : **00800 - 67 10 83 00**

for Austria, Belgium, Denmark, Finland, France, Germany, Italy, Luxemburg,
Netherlands, Norway, Portugal, Spain, Sweden, Switzerland, United Kingdom

* Please note some (mobile) phone services/provider do not permit access or
request an additional prefix to +800 numbers.

For all not listed European Countries and in case that you can't get connected to
the above mentioned number please make use of the following

CHARGED NUMBERS: **+49 180 5 - 67 10 83** or **+49 40 - 237 73 899**

Our Technical Customer Support is available from 9 am to 6 pm MET (Monday to Friday)