

Nikon

DIGITAL CAMERA

COOLPIX L11 L10

User's Manual



En

Trademark Information

Macintosh, Mac OS, and QuickTime are registered trademarks of Apple Computer, Inc. Microsoft and Windows are registered trademarks of Microsoft Corporation.

The SD logo is a trademark of the SD Card Association. Adobe and Acrobat are registered trademarks of Adobe Systems Inc. PictBridge is a trademark. D-Lighting technology is provided by  Apical Limited. All other trade names mentioned in this manual or the other documentation provided with your Nikon product are trademarks or registered trademarks of their respective holders.

Introduction

Preparation for Shooting

Basic Photography and
Playback:  (Auto) Mode

Shooting Suited for the Scene
-  Scene Mode

 More on Playback

 Recording and Viewing Movies

 Voice Recordings

Connecting to Televisions,
Computers, and Printers

MENU Shooting, Playback, and
Setup Menus

Technical Notes

For Your Safety

To prevent damage to your Nikon product or injury to yourself or to others, read the following safety precautions in their entirety before using this equipment. Keep these safety instructions where all those who use the product will read them.

The consequences that could result from failure to observe the precautions listed in this section are indicated by the following symbol:



This icon marks warnings, information that should be read before using this Nikon product to prevent possible injury.

WARNINGS

Turn off in the event of malfunction

Should you notice smoke or an unusual smell coming from the camera or AC adapter, unplug the AC adapter and remove the batteries immediately, taking care to avoid burns. Continued operation could result in injury. After removing or disconnecting the power source, take the equipment to a Nikon-authorized service representative for inspection.

Do not disassemble

Touching the product's internal parts could result in injury. Repairs should be performed only by qualified technicians. Should the camera break open as the result of a fall or other accident, take the product to a Nikon-authorized service representative for inspection after unplugging the product and/or removing the batteries.

Do not use the camera or AC adapter in the presence of flammable gas

Do not use electronic equipment in the presence of flammable gas, as this could result in explosion or fire.

Handle the camera strap with care

Never place the strap around the neck of an infant or child.

Keep out of reach of children

Particular care should be taken to prevent infants from putting the batteries or other small parts into their mouths.

Observe caution when handling batteries

Batteries may leak or explode if improperly handled. Observe the following precautions when handling batteries for use in this product:

- Before replacing the batteries, turn the product off. If you are using an AC adapter, be sure it is unplugged.
- Use only the batteries approved for use in this product (Ⓝ 10). Do not combine old and new batteries or batteries of different makes or types.
- If Nikon rechargeable EN-MH1 NiMH batteries are purchased separately, charge and use each of them as a set. Do not combine batteries from different pairs.
- Insert batteries in the correct orientation.
- Do not short or disassemble batteries or attempt to remove or break battery insulation or casing.
- Do not expose batteries to flame or to excessive heat.
- Do not immerse in or expose to water.
- Do not transport or store with metal objects such as necklaces or hairpins.
- Batteries are prone to leakage when fully discharged. To avoid damage to

the product, be sure to remove the batteries when no charge remains.

- Discontinue use immediately should you notice any change in the batteries, such as discoloration or deformation.
- If liquid from damaged batteries comes in contact with clothing or skin, rinse immediately with plenty of water.

Observe the following precautions when handling the Battery Charger MH-71 (available separately)

- Keep dry. Failure to observe this precaution could result in fire or electric shock.
- Dust on or near the metal parts of the plug should be removed with a dry cloth. Continued use could result in fire.
- Do not handle the power cable or go near the battery charger during lightning storms. Failure to observe this precaution could result in electric shock.
- Do not damage, modify, forcibly tug or bend the power cable, place it under heavy objects, or expose it to heat or flame. Should the insulation be damaged and the wires become exposed, take it to a Nikon-authorized service representative for inspection. Failure to observe these precautions could result in fire or electric shock.
- Do not handle the plug or battery charger with wet hands. Failure to observe this precaution could result in electric shock.

Use appropriate cables

When connecting cables to the input and output jacks, use only the cables provided or sold by Nikon for the purpose, to maintain compliance with product regulations.

Handle moving parts with care

Be careful that your fingers or other objects are not pinched by the lens cover or other moving parts.

CD-ROMs

The CD-ROMs supplied with this device should not be played back on audio CD equipment. Playing CD-ROMs on an audio CD player could cause hearing loss or damage the equipment.

Observe caution when using the flash

Using the flash close to your subject's eyes could cause temporary visual impairment. Particular care should be observed if photographing infants, when the flash should be no less than one meter (39 in.) from the subject.

Do not operate the flash with the flash window touching a person or object

Failure to observe this precaution could result in burns or fire.

Avoid contact with liquid crystal

Should the monitor break, care should be taken to avoid injury caused by broken glass and to prevent liquid crystal from the monitor touching the skin or entering the eyes or mouth.

Notices

Notice for Customers in the U.S.A.

Federal Communications Commission (FCC) Radio Frequency Interference Statement

This equipment has been tested and found to comply with the limits for a Class B digital device, pursuant to Part 15 of the FCC rules. These limits are designed to provide reasonable protection against harmful interference in a residential installation. This equipment generates, uses, and can radiate radio frequency energy and, if not installed and used in accordance with the instructions, may cause harmful interference to radio communications. However, there is no guarantee that interference will not occur in a particular installation. If this equipment does cause harmful interference to radio or television reception, which can be determined by turning the equipment off and on, the user is encouraged to try to correct the interference by one or more of the following measures:

- Reorient or relocate the receiving antenna.
- Increase the separation between the equipment and receiver.
- Connect the equipment into an outlet on a circuit different from that to which the receiver is connected.
- Consult the dealer or an experienced radio/television technician for help.



Nikon
COOLPIX L11/L10

CAUTIONS

Modifications

The FCC requires the user to be notified that any changes or modifications made to this device that are not expressly approved by Nikon Corporation may void the user's authority to operate the equipment.

Interface Cables

Use the interface cables sold or provided by Nikon for your equipment. Using other interface cables may exceed the limits of Class B Part 15 of the FCC rules.

Notice for customers in the State of California

WARNING: Handling the cord on this product will expose you to lead, a chemical known to the State of California to cause birth defects or other reproductive harm. *Wash hands after handling.*

Nikon Inc.,
1300 Walt Whitman Road
Melville, New York 11747-3064 USA
Tel: 631-547-4200

Notice for customers in Canada

CAUTION

This Class B digital apparatus complies with Canadian ICES-003.

ATTENTION

Cet appareil numérique de la classe B est conforme à la norme NMB-003 du Canada.

Symbol for Separate Collection in European Countries



This symbol indicates that this product is to be collected separately.





The following apply only to users in European countries:





























- This product is designed for separate collection at an appropriate collection point. Do not dispose of as household waste.
- For more information, contact the retailer or the local authorities in charge of waste management.

Table of Contents

Introduction	ii
For Your Safety	ii
WARNINGS.....	ii
Notices.....	iv
About This Manual	1
Information and Precautions	2
Parts of the Camera	4
The Monitor	6
Shooting.....	6
Playback	7
Basic Operations/Displaying the Help.....	8
Mode Selector	8
Multi Selector	8
MENU Button	9
Help Displays	9
Preparation for Shooting	10
Inserting Batteries	10
Insert the Batteries.....	10
Supported Batteries	10
Turning On and Off the Camera	10
Setting Display Language, Date, and Time.....	12
Inserting Memory Cards	14
Removing Memory Cards.....	15
Basic Photography and Playback:  (Auto) Mode	16
Step1 Select  (Auto) Mode and Turn the Camera On.....	16
Step2 Frame a Picture.....	18
Step3 Focus and Shoot	20
Step4 Viewing and Deleting Pictures	22
Using the Flash.....	24
Taking Pictures with the Self-Timer.....	26
Macro Close-up Mode	27
Exposure Compensation.....	28
Shooting Suited for the Scene -  Scene Mode	29
Scene Modes	29
Features.....	31

 More on Playback	40
Viewing Multiple Pictures: Thumbnail Playback.....	40
Taking a Closer Look: Playback Zoom	41
Editing Pictures	42
Enhancing Brightness and Contrast: D-Lighting.....	43
Creating a Cropped Copy: Crop	44
 Resizing Pictures: Small Picture	45
Voice Memos: Recording and Playback	46
Recording Voice Memos	46
Playing Voice Memos.....	47
Deleting Voice Memos.....	47
 Movies	48
Recording Movies	48
The Movie Menu.....	49
Movie Options.....	49
Applying Movie Setting.....	50
Movie Playback	51
Deleting Movie Files.....	51
 Voice Recordings	52
Making Voice Recordings.....	52
Playing Voice Recordings	54
Copying Voice Recordings.....	56
Connecting to Televisions, Computers, and Printers	57
Connecting to a TV.....	58
Connecting to a Computer.....	59
Before Connecting the Camera.....	59
Setting the USB Option.....	60
Transferring Pictures to a Computer.....	61
Connecting to a Printer	63
Connecting the Camera and Printer.....	64
Printing Pictures One at a Time	65
Printing Multiple Pictures	66
Creating a DPOF Print Order: Print Set.....	69
Connecting to an ImageLink-compatible Printer	72

MENU Shooting, Playback, and Setup Menus	73
Shooting Options: The Shooting Menu.....	73
 Image Mode.....	74
 White Balance	76
 Continuous	78
 Best Shot Selector (BSS).....	79
 Color Options	79
Restrictions on Camera Settings.....	80
Playback Options: The Playback Menu.....	81
 Slide Show.....	83
 Delete.....	84
 Protect.....	84
 Transfer Marking.....	85
 Copy.....	86
Basic Camera Setup: The Setup Menu	87
 Menus	88
 Quick Startup	89
 Welcome Screen.....	89
 Date	90
 Monitor Settings	93
 Date Imprint	94
 Sound Settings	96
 Blur Warning	96
 Auto Off.....	97
 Format Memory/  Format Card.....	98
 Language.....	99
 Interface	99
 Reset All	100
 Battery Type	101
 Firmware Version	101
Technical Notes.....	102
Optional Accessories.....	102
Image/Sound File and Folder Names	103
Caring for the Camera.....	104
Cleaning.....	105
Storage.....	106
Error Messages.....	107
Troubleshooting	113
Specifications	117
Index.....	121

About This Manual

Thank you for your purchase of a Nikon COOLPIX L11/COOLPIX L10 digital camera. This manual has been written to help you enjoy taking pictures with your Nikon digital camera. Read this manual thoroughly before use, and keep it where all those who use the product will read it.

Symbols and Conventions

To make it easier to find the information you need, the following symbols and conventions are used:



This icon marks cautions, information that should be read before use to prevent damage to the camera.



This icon marks tips, additional information that may be helpful when using the camera.



This icon marks notes, information that should be read before using the camera.



This icon indicates that more information is available elsewhere in this manual or in the *Quick Start Guide*.

Notations

- A Secure Digital (SD) memory card is referred to as a “memory card.”
- The setting at the time of purchase is referred to as the “default setting.”
- The names of menu items displayed in the camera monitor, and the names of buttons or messages displayed in the computer monitor are indicated with brackets ([]).

Screen Samples

In this manual, images are sometimes omitted from monitor display samples so that monitor icons can be more clearly shown.

Illustrations and Screen Displays

- Illustrations and text displays shown in this manual may differ from actual display.
- Illustrations and text displays shown in this manual are for COOLPIX L11. COOLPIX L11 and COOLPIX L10 differ in the Image mode.

COOLPIX L11: , , , , and

COOLPIX L10: , , , , and

Product Names

In this manual, the product names “COOLPIX L11” and “COOLPIX L10” may sometimes be abbreviated as “L11” and “L10”.



Memory Cards

Pictures taken with this camera can be stored in the camera’s internal memory or on removable memory cards. If a memory card is inserted, all new pictures will be stored on the memory card and delete, playback, and format operations will apply only to the pictures on the memory card. The memory card must be removed before the internal memory can be formatted or used to store, delete, or view pictures.

Information and Precautions

Life-Long Learning

As part of Nikon's "Life-Long Learning" commitment to ongoing product support and education, continually updated information is available online at the following sites:

- For users in the U.S.A.: <http://www.nikonusa.com/>
 - For users in Europe and Africa: <http://www.europe-nikon.com/support>
 - For users in Asia, Oceania, and the Middle East: <http://www.nikon-asia.com/>
- Visit these sites to keep up-to-date with the latest product information, tips, answers to frequently asked questions (FAQs), and general advice on digital imaging and photography. Additional information may be available from the Nikon representative in your area. See the URL below for contact information: <http://nikonimaging.com/>

Use Only Nikon Brand Electronic Accessories

Nikon COOLPIX cameras are designed to the highest standards and include complex electronic circuitry. Only Nikon brand electronic accessories (including battery chargers, batteries, and AC adapters) certified by Nikon specifically for use with this Nikon digital camera are engineered and proven to operate within the operational and safety requirements of this electronic circuitry.

THE USE OF NON-NIKON ELECTRONIC ACCESSORIES COULD DAMAGE THE CAMERA AND MAY VOID YOUR NIKON WARRANTY.

For more information about Nikon brand accessories, contact a local authorized Nikon dealer.

Before Taking Important Pictures

Before taking pictures on important occasions (such as at weddings or before taking the camera on a trip), take a test shot to ensure that the camera is functioning normally. Nikon will not be held liable for damages or lost profits that may result from product malfunction.

About Manuals

- No part of the manuals included with this product may be reproduced, transmitted, transcribed, stored in a retrieval system, or translated into any language in any form, by any means, without Nikon's prior written permission.
- Nikon reserves the right to change the specifications of the hardware and software described in these manuals at any time and without prior notice.
- Nikon will not be held liable for any damages resulting from the use of this product.
- While every effort has been made to ensure that the information in these manuals is accurate and complete, we would appreciate it were you to bring any errors or omissions to the attention of the Nikon representative in your area (address provided separately).

Notice Concerning Prohibition of Copying or Reproduction

Note that simply being in possession of material that has been digitally copied or reproduced by means of a scanner, digital camera or other device may be punishable by law.

- **Items prohibited by law from being copied or reproduced**

Do not copy or reproduce paper money, coins, securities, government bonds, or local government bonds, even if such copies or reproductions are stamped "Sample."

The copying or reproduction of paper money, coins, or securities which are circulated in a foreign country is prohibited.

Unless the prior permission of the government has been obtained, the copying or reproduction of unused postage stamps or post cards issued by the government is prohibited.

The copying or reproduction of stamps issued by the government and of certified documents stipulated by law is prohibited.

- **Cautions on certain copies and reproductions**

The government has issued cautions on copies or reproductions of securities issued by private companies (shares, bills, checks, gift certificates, etc.), commuter passes, or coupon tickets, except when a minimum of necessary copies are to be provided for business use by a company. Also, do not copy or reproduce passports issued by the government, licenses issued by public agencies and private groups, ID cards, and tickets, such as passes and meal coupons.

- **Comply with copyright notices**

The copying or reproduction of copyrighted creative works such as books, music, paintings, woodcut prints, maps, drawings, movies, and photographs is governed by national and international copyright laws. Do not use this product for the purpose of making illegal copies or to infringe copyright laws.

Disposing of Data Storage Devices

Please note that deleting images or formatting data storage devices such as memory cards or built-in camera memory does not completely erase the original image data. Deleted files can sometimes be recovered from discarded storage devices using commercially available software, potentially resulting in the malicious use of personal image data. Ensuring the privacy of such data is the user's responsibility.

Before discarding a data storage device or transferring ownership to another person, erase all data using commercial deletion software, or format the device and then completely refill it with images containing no private information (for example, pictures of empty sky). Be sure to also replace any pictures selected for the welcome screen (📷 89). Care should be taken to avoid injury or damage to property when physically destroying data storage devices.

Parts of the Camera

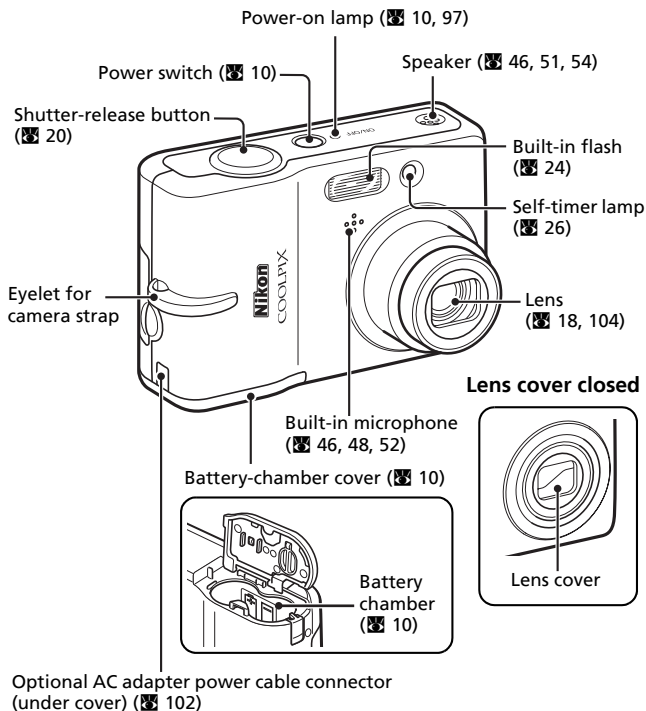

Attaching the Camera Strap

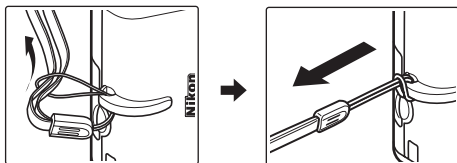

Opening the connector cover

Cable connector

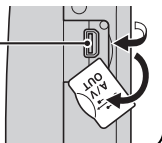

Connector cover (📖 58, 61, 64)

Flash lamp (📖 24)

Indicator lamp (📖 52)

Zoom buttons (📖 18)

See also:

- **W** (wide): 📖 18
- **T** (tele): 📖 18
- (thumbnail playback): 📖 40
- (playback zoom): 📖 41
- (help): 📖 9

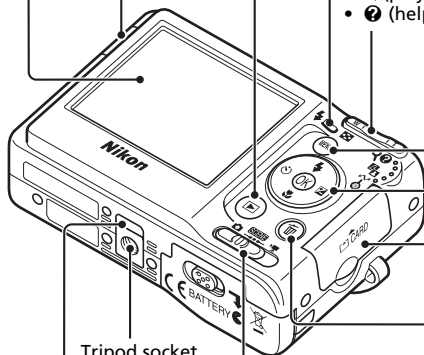
Monitor
(📖 6) (playback) button
(📖 22, 40)

MENU button (📖 9)

Memory card slot
cover (📖 14) (delete) button
(📖 22, 41, 47, 51)

Tripod socket

Mode selector (📖 8, 16, 29, 48)

ImageLink connector (📖 72)

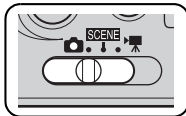

Multi selector (📖 8)

: Display self-timer menu
(📖 26): Display macro close-up
mode menu (📖 27): Display flash mode
menu (📖 24): Make selection/
transfer picture (📖 59)
Apply D-Lighting (📖 43): Adjust the exposure
setting (📖 28)

The Monitor

The following indicators may appear in the monitor during shooting and playback (actual display varies with current camera settings).

Shooting

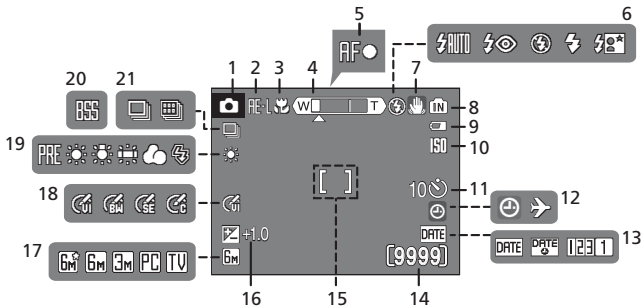

1	Shooting mode ¹ 16, 29, 48	12	"Date not set" indicator 107 Time zone indicator 90
2	Exposure lock 38	13	Date imprint/Date counter 94
3	Macro close-up mode 27	14	Number of exposures remaining 16 Movie length 48
4	Zoom indicator 18, 27	15	Focus area 20
5	Focus indicator 20	16	Exposure compensation value 28
6	Flash mode 24	17	Image mode ² 74
7	Camera shake icon 25	18	Color options setting 79
8	Internal memory indicator . 17	19	White balance 76
9	Battery level indicator 16	20	Best shot selector (BSS) 79
10	ISO Sensitivity 25	21	Continuous shooting mode 78
11	Self-timer indicator 26		

¹ Differs according to the current shooting mode.

² GM, 3M, PC, and TV are available for COOLPIX L10.

Playback

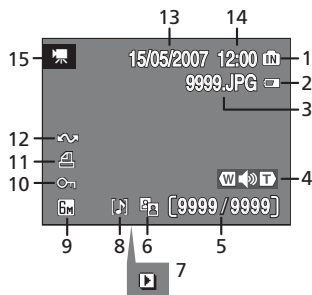

1 Internal memory indicator . 22	8 Voice memo icon 46
2 Battery level indicator 16	9 Image mode..... 74
3 File number and type..... 103	10 Protect icon..... 84
4 Volume indicator..... 46, 51	11 Print-order icon 70
5 Current frame number/ total number of frames/ 22 movie length 51	12 Transfer icon 62, 85
6 D-Lighting icon 43	13 Date of recording 12
7 Movie playback indicator... 51	14 Time of recording..... 12
	15 Movie indicator 51

Basic Operations/Displaying the Help

Mode Selector

Set the mode selector to the desired mode.

SCENE: Scene mode (📷 29)

Select one of 16 "scenes" suited to different subjects of shooting conditions, such as indoor parties or night landscapes, and let the camera do the rest. You can also record sounds or play back recorded sounds using Voice recording.

📷: Auto mode (📷 16)

A simple "point-and-shoot" mode in which the majority of camera settings are controlled by the camera.

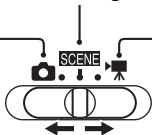

📽: Movie mode (📽 48)

Record movies. Select one of five movie options.

Multi Selector

In addition to activating the flash, macro-close up, self-timer, and exposure compensation modes and functions, the multi selector is also used to perform the following operations.

Full-Frame Playback

Display the previous picture (📷 22).
(◀ or ▲)

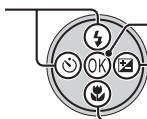

Apply D-Lighting (📷 43)

Display the next picture (📷 22).
(▶ or ▼)

Navigating the Menus

Return to the previous menu, or move cursor left (◀).

Move cursor down (▼).

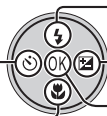

Move cursor up (▲).





Display the sub-menu, move cursor right, or make selection (▶).

Make selection.

* In the manual, the multi selector buttons for moving the cursor or selection up, down, left, and right are shown as ▲, ▼, ◀, and ▶.

MENU Button

When **MENU** is pressed, the following menus are displayed according to the mode that has been selected.

-  : Auto mode → **Shooting menu** (📷 73)
-  : Scene mode → **Scene menu** (📷 29)
-  : Movie mode → **Movie menu** (📷 49)
-  : Playback mode → **Playback menu** (📷 81)

To display the setup menu (📷 87), choose [Set up] at the top of all menus.

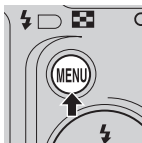

Displayed when there are one or more previous menu items.

Displayed when there are one or more menu items to follow.

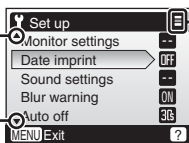

Displayed when the menu contains two or more pages.

Help Displays

Press **T** (🔍) to view a description of the currently selected menu option.

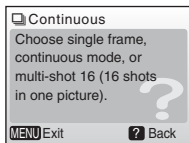
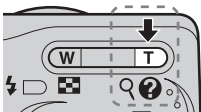

- To return to the original menu, press **T** (🔍) again.
- Press **MENU** to return to shooting or playback mode.

Preparation for Shooting

Inserting Batteries

Insert the Batteries

1 Open the battery-chamber cover.

- Hold the camera upside down to prevent the batteries from falling out.



2 Insert the batteries.

- Insert the batteries correctly as shown at right.

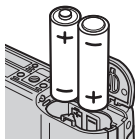

3 Close the battery-chamber cover.



Supported Batteries

This camera uses the following batteries.

- Two LR6 alkaline (AA-size) batteries (supplied)
- Two ZR6 oxyride (AA-size) batteries (available separately)
- Two FR6 lithium (AA-size) batteries (available separately)
- Two EN-MH1 Rechargeable Ni-MH Batteries (available separately from Nikon)

Turning On and Off the Camera

To turn on the camera, press the power switch. The power-on lamp (green) will light for a moment and the monitor will turn on.

To turn off the camera, press the power switch again.

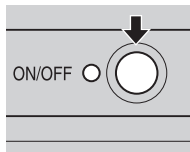

✓ Replacing Batteries

Turn the camera off and make sure that the power-on lamp and the monitor have gone out before removing or inserting batteries.

✓ Additional Precautions Regarding Batteries

- Read and follow the warnings and cautions on pages ii-iii and 105 of this manual.
- Do not combine old and new batteries or batteries of different makes or types.
- Batteries with the following defects cannot be used:

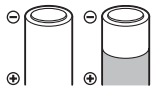

Batteries with peeling



Batteries with insulation that does not cover the area around the negative terminal.

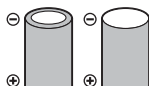

Batteries with a flat negative terminal

✓ Battery Type

To improve battery performance, select the type of battery currently inserted in the camera in the setup menu. The default setting is [Alkaline]. When any other type of battery is used, turn the camera on and change the setting (🔍 101).

✍ Alkaline Batteries

Performance of alkaline batteries may vary greatly depending on the manufacturer. Choose a reliable brand.

✍ Alternative Power Resources

To power the camera continuously for extended periods, use an AC Adapter EH-65A (available separately from Nikon) (🔍 102). **Do not, under any circumstances, use another make or model of AC adapter.** Failure to observe this precaution could result in overheating or in damage to the camera.

✍ Power Saving Function

If no operations are performed for about five seconds, the monitor will dim to save power. Using any of the camera controls will reactivate the display. If no operations are performed for about 30 seconds, the monitor will turn off; after a further three minutes, the camera will turn off automatically.

Setting Display Language, Date, and Time

A language-selection dialog is displayed the first time the camera is turned on.

1 Press the power switch to turn on the camera.

- The power-on lamp will light for a moment and the monitor will turn on.

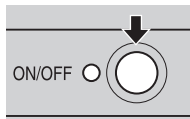

2 Press the multi selector ▲, ▼, ◀ or ▶ to choose the desired language and press OK.

- For information on using the multi selector, see "Multi Selector" (8).



3 Press ▲ or ▼ to choose [Yes] and press OK.

- If [No] is selected, the date and time will not be set.

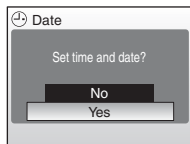

4 Press ▶.

- The [Home time zone] menu is displayed.

Daylight Saving Time

If daylight saving time is in effect, turn on [Daylight saving] in the time zone menu and set the date.

- Before pressing OK, press the multi selector ▼ to choose [Daylight saving].
- Press OK to enable daylight saving time (✓). Pressing OK toggles the daylight saving time option on and off.
- Press the multi selector ▲, and then ▶ and proceed to step 5.

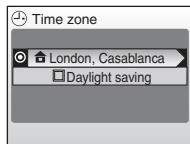

When daylight saving time ends, turn [Daylight saving] off from the [Date] menu (90) in the setup menu (87). The camera's clock is automatically set back one hour.

- 5** Press ◀ or ▶ to choose your home time zone (92) and press OK.

- The [Date] menu is displayed.

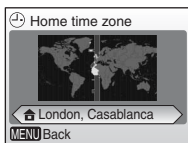

- 6** Press ▲ or ▼ to edit the day ([D]) (order of day, month, and year may differ in some areas) and press ▶.

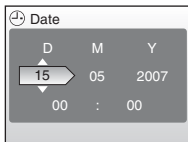

- 7** Press ▲ or ▼ to edit the month ([M]) and press ▶.

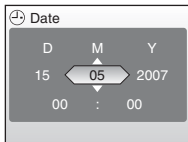

- 8** Press ▲ or ▼ to edit year ([Y]), hour, and minutes. Press ▶ after setting each item.

- [D], [M], and [Y] blink.

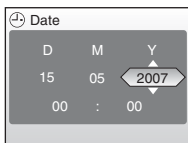

- 9** Choose the order in which the day, month, and year are displayed and press OK.

- The settings are applied and monitor display returns to the standard display for the current mode.

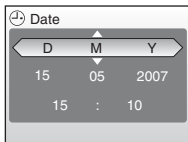

Inserting Memory Cards

Pictures and voice recordings are stored in the camera's internal memory (approx. 7 MB) or on removable Secure Digital (SD) memory cards (available separately) (❗ 102).

If a memory card is inserted in the camera, pictures are automatically stored on the memory card and only pictures recorded to the memory card can be played back, deleted, or transferred. Remove the memory card to store pictures in the internal memory, or play back, delete, or transfer pictures from the internal memory.

- 1 Turn the camera off, and open the memory card slot cover.

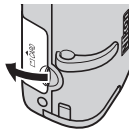

- 2 Insert the memory card.

- Make sure that the camera is off (power-on lamp is off) before inserting or removing the memory card.
- Slide the memory card in as shown until it clicks into place.
- Close the memory card slot cover.

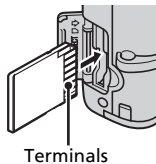

❗ Inserting Memory Cards
Inserting the memory card upside down or backwards could damage the camera or the memory card. Be sure that the memory card is correctly oriented.

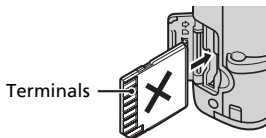
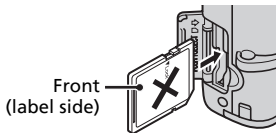

Removing Memory Cards

Turn the camera off and make sure that the power-on lamp and the monitor are off before opening the memory card slot cover. Press the memory card lightly (①) to release it. Once released, pull the memory card out carefully (②).

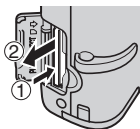

Formatting Memory Cards

If the message at right is displayed when the power is on, the memory card must be formatted (98) before use.

Note that *formatting permanently deletes all pictures* and other data on the memory card. Be sure to make copies of any pictures you wish to keep before beginning formatting.

To begin formatting, press the multi selector ▲ or ▼ to choose [Format] and then press \odot .

Do not turn the camera off or remove the batteries or memory card until formatting is complete.

The first time you insert the memory cards used in other devices into the COOLPIX L11 or COOLPIX L10, be sure to format them (98).

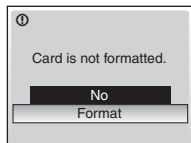

The Write Protect Switch

SD memory cards are equipped with a write protect switch. Pictures cannot be recorded or deleted and the memory card cannot be formatted when this switch is in the "Lock" position.

Write protect switch

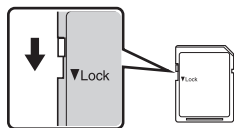

Memory Cards

- Use only Secure Digital (SD) memory cards.
- Do not perform the following during formatting, while data are being written to or deleted from the memory card, or during data transfer to a computer. Failure to observe this precaution could result in the loss of data or in damage to the camera or memory card.
 - Eject the memory card
 - Remove the battery
 - Turn off the camera
 - Disconnect the AC adapter
- Do not disassemble or modify.
- Do not drop, bend, or expose to water or strong physical shock.
- Do not touch the metal terminals with your fingers or metal objects.
- Do not affix labels or stickers to the memory card.
- Do not leave in direct sunlight, closed vehicles, or areas exposed to high temperatures.
- Do not expose to humidity or to corrosive gases.

Step1 Select  (Auto) Mode and Turn the Camera On

This section describes how to take pictures in  (auto) mode, an automatic, “point-and-shoot” mode recommended for first-time users of digital cameras.

- 1** Slide the mode selector to .

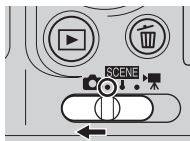

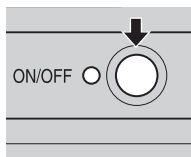

- 2** Turn the camera on.

- The power-on lamp (green) will light for a moment and the monitor will turn on.



- 3** Check the battery level and number of exposures remaining.

Battery Level

Monitor	Description
NO INDICATOR	Batteries fully charged.
	Batteries low; ready spare batteries.
 Warning! Battery exhausted.	Batteries exhausted. Replace with fresh batteries.

Battery level indicator

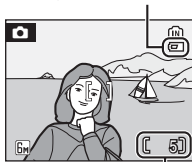

Number of exposures remaining

Number of Exposures Remaining

The number of pictures that can be stored depends on the capacity of the internal memory or memory card and option chosen for the image mode setting.

Indicators in (auto) Mode

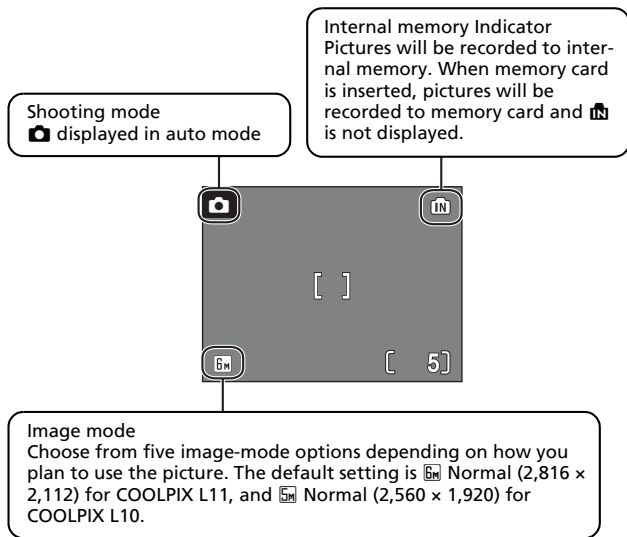

Available Functions in Auto Shooting Mode

In (camera icon) mode, macro close-up mode (27) and exposure compensation (28) can be applied and pictures can be taken using the flash (24) and self-timer (26). Press **MENU** in (camera icon) (auto) mode to display the shooting menu. The shooting menu allows you to specify the image mode (74), white balance setting (76), and to apply continuous shooting (78), BSS (79), and color options (79) to suit shooting conditions or your own preferences.

Step2 Frame a Picture

1 Ready the camera.

- Hold the camera steadily in both hands, keeping your fingers and other objects away from the lens, flash, and microphone.
- When taking pictures in “tall” orientation, turn the camera counterclockwise so that the built-in flash is above the lens.



2 Frame the picture.

- Frame the picture with the main subject positioned near the center of the monitor.



Using the Zoom

Use the zoom buttons to activate optical zoom. Press **W** (📷) to zoom out, increasing the area visible in the frame, or **T** (🔍) to zoom in so that the subject fills a larger area of the frame.

Zoom out Zoom in

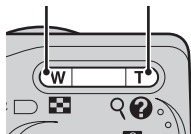

When the camera is zoomed in to the maximum magnification (3×), holding **T** (🔍) down triggers digital zoom. The subject is magnified up to 4×, for a total magnification of 12×.

A monitor indicator shows the current zoom ratio.



Zoom indicator displayed when the zoom buttons are pressed.

Optical zoom (up to 3×)

Zoom indicator turns yellow when digital zoom is in effect.

Digital Zoom

Unlike optical zoom, data from the camera's image sensor are processed digitally with digital zoom. Details visible at maximum optical zoom are simply enlarged, producing a slightly "grainy" image.

Step3 Focus and Shoot

1 Press the shutter-release button halfway.

- The camera focuses on the subject in the center of the focus area. When the subject is in focus, the focus indicator (AF●) is green. When the camera is unable to focus, the focus indicator blinks red. Change the composition and try again.

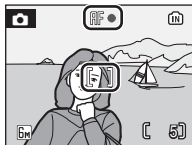



2 Press the shutter release button the rest of the way down to take the picture.

- The shutter will be released, and the picture will be recorded to the memory card or internal memory.
- Note that the flash may fire if the subject is poorly lit.



✓ During Recording

While pictures are being recorded, the  icon will be displayed, or the  icon will blink. Do not turn the camera off, eject the memory card, open the battery-chamber cover, or disconnect the power source while these icons are displayed. Cutting power or removing the memory card in these circumstances could result in loss of data or in damage to the camera or card.

Autofocus

Autofocus may not perform as expected in the following situations:

- Subject is very dark
- Objects of sharply differing brightness are included in the scene (e.g., the sun is behind the subject and is in deep shadow)
- No contrast between the subject and surroundings (e.g., when the subject is standing in front of a white wall, wearing a white shirt)
- Several objects are at different distances from the camera (e.g., the subject is inside a cage)
- Subject is moving rapidly
- In the situation noted above, try pressing the shutter-release button halfway to refocus several times, or use focus lock.

Shutter-Release Button

To set focus and exposure, press the shutter-release button halfway, stopping when you feel resistance. Focus and exposure lock while the shutter-release button is held in this position. To release the shutter and take a picture, press the shutter-release button down the rest of the way. Do not use force when pressing the shutter-release button, as this may result in camera shake and blurred pictures.



Focus Lock

To focus on off-center subject, use focus lock as described below.

- Be sure that the distance between the camera and the subject does not change while focus is locked.



Position the subject in the center of the frame.

Press the shutter-release button halfway.

Confirm that the focus indicator (AF●) is green.









Continue holding down the shutter-release button halfway and recompose the picture.

Press the shutter-release button the rest of the way down.

Step4 Viewing and Deleting Pictures

Full-Frame Playback

Press .

- The last picture taken will be displayed. Press the multi selector , , , or  to view additional pictures.
- For information on using the multi selector, see “Multi Selector” ( 8).
- Pictures may be displayed briefly at low resolution while being read from the memory card or internal memory.
- Press  again or press the shutter-release button to switch to shooting mode.
- When  is displayed, pictures stored in the internal memory will be displayed. When memory card is inserted,  is not displayed and pictures stored on the memory card will be displayed.

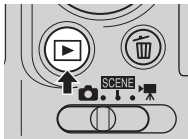



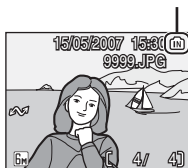

Internal memory indicator



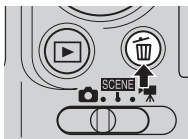

Deleting Pictures

- 1 Press  to delete the picture currently displayed in the monitor.



- 2 Press the multi selector  or  to choose [Yes] and press .





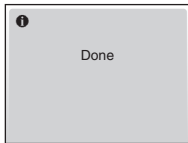
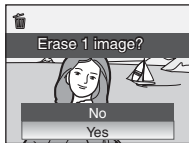

- To exit without deleting the picture, choose [No] and press .

- For information on using the multi selector, see “Multi Selector” ( 8).



Full-Frame Playback Mode





The following functions are available in the full-frame playback mode.

Option	Press	Description	
Enlarge picture	 (T)	Enlarge view of picture currently displayed in the monitor up to about 10x.	41
View thumbnails	 (W)	Display four or nine picture thumbnails.	40
D-lighting	 (OK)	Enhance brightness and contrast in dark portions of the pictures.	43
Switch to shooting mode	 	Press  or the shutter-release button to switch to the shooting mode selected with the mode selector.	22

Viewing Pictures

- When the camera is off, holding down  will turn the camera on in the full-frame playback mode.
- Pictures stored to the internal memory can only be viewed if no memory card is inserted.

Deleting the Last Picture Taken





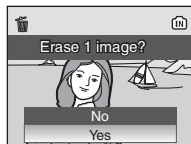

In shooting mode, press  to delete the last picture taken. When the confirmation dialog shown at right is displayed, press the multi selector  or  to choose [Yes] and press .

To exit without deleting the picture, choose [No] and press .



Using the Flash

The flash has a range of 0.4–3.0 m (1 ft. 4 in.–9 ft. 10 in.) when the camera is zoomed out all the way. With maximum optical zoom applied, the range is 0.4–2.5 m (1 ft. 4 in.–8 ft. 2 in.). The following flash modes are available:





-  **Auto (default setting in  mode)**
Flash fires automatically when lighting is poor.
-  **Auto with red-eye reduction**
Reduces “red eye” in portraits ( 25).
-  **Off**
Flash will not fire even when lighting is poor.
-  **Fill flash**
Flash fires whenever picture is taken. Use to “fill-in” (illuminate) shadows and back-lit subjects.
-  **Slow sync**
Flash illuminates main subject; slow shutter speeds are used to capture background at night or under dim light.

1 Press (flash mode).

- The flash menu is displayed.



2 Press the multi selector or to choose the desired flash mode and press .

- If a setting is not applied by pressing  within five seconds, the selection will be cancelled.
- For information on using the multi selector, see “Multi Selector” ( 8).
- The icon for the selected flash mode is displayed at the top of the monitor. When  is applied,  is only displayed for five seconds.
- The flash mode applied in  mode is stored in the camera’s memory even after the camera is turned off.

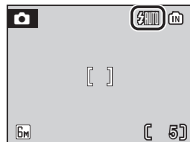
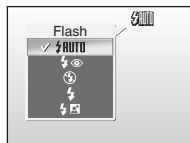

✓ When Lighting is Poor

When lighting is poor and the flash is off (⊕), the  or **ISO** icon may appear on the monitor. Note the following.

- Place the camera on a flat, level surface or use a tripod (recommended).
- If the warning at right is displayed after a picture is taken, the picture may be blurred. Select [No] to exit without recording the picture.
- The **ISO** icon is displayed when the camera increases sensitivity from the normal sensitivity to minimize blur caused by slow shutter speeds. The picture taken when the **ISO** icon is displayed may be slightly mottled.
- The camera may process pictures to reduce noise, increasing recording time.

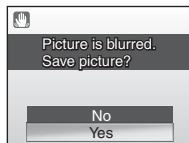

✓ Note on Using the Flash

When using the flash at a wide-angle zoom position, bright reflections from dust particles in the air may appear as bright spots in the pictures. To reduce these reflections, set the flash to ⊕ (Off) in the monitor or zoom in on the subject.

✍ The Flash Lamp

The flash lamp indicates flash status when the shutter-release button is pressed half-way.

- **On** : Flash will fire when picture is taken.
- **Blinks**: Flash charging. Wait a few seconds and try again.
- **Off** : Flash will not fire when picture is taken.

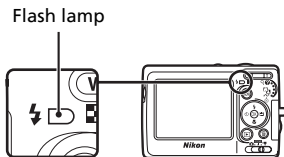

✍ Red-eye Reduction

The COOLPIX L11/COOLPIX L10 is equipped with an advanced red-eye reduction system. Pre-flashes are fired several times at low intensity before the main flash to reduce "red-eye". If the camera detects "red-eye" after a picture is taken, Nikon's own In-Camera Red-Eye Fix processes the image as it is recorded. Therefore, there is a slight delay before the shutter-release button operates normally to take another picture. Red-eye reduction may not always produce the desired results. In some rare cases, other portion of pictures may be affected. Should this occur, choose another flash mode and try again.

Taking Pictures with the Self-Timer



The camera is equipped with a ten-second timer for self-portraits. When using the self-timer, mount the camera on a tripod (recommended) or rest it on a flat, and stable surface.

1 Press (self-timer).

- The self-timer menu is displayed.



2 Press the multi selector or to choose [ON] and press .

- The 10 icon is displayed.
- If a setting is not applied by pressing  within five seconds, the selection will be cancelled.
- For information on using the multi selector, see "Multi Selector" ( 8).

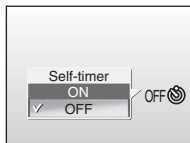

3 Frame the picture and press the shutter-release button halfway.

- Focus and exposure will be set.

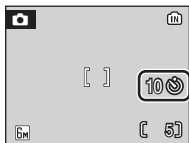

4 Press the shutter-release button the rest of the way down.

- The self-timer starts and the self-timer lamp will blink. The lamp stops blinking one second before the photograph is taken and remains lit until the shutter is released.
- The number of seconds remaining before the shutter is released is displayed in the monitor.
- To stop the timer before a picture is taken, press the shutter-release button again.

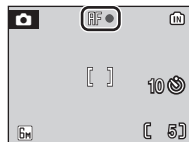

Macro Close-up Mode





Macro close-up mode is used for taking pictures of objects as close as 15 cm (5.9 in.). Note that the flash may be unable to light the entire subject at distances of less than 40 cm (15.7 in.). If flash fires, play the picture back and check the results.

1 Press (macro close-up mode).

- The macro close-up mode is displayed.



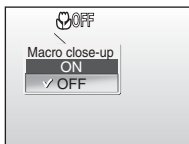

2 Press the multi selector or to choose [ON] and press .

- The macro close-up mode icon () is displayed.
- When [OFF] is selected, OFF is only displayed for five seconds.
- The monitor will return to the normal display for the current mode if the setting is not applied by pressing  within five seconds.
- For information on using the multi selector, see “Multi Selector” ( 8).



3 Press **T** () or **W** () to frame the picture.

- The camera can focus at a distance of 15 cm (5.9 in.) at the zoom position at which  () glows green.



4 Focus and shoot.

- The macro close-up mode applied in  mode is stored in the camera's memory even after the camera is turned off.

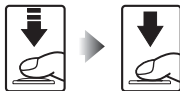

Macro Close-up Mode

In macro close-up mode, the camera focuses continuously, even when the shutter-release button is not pressed halfway to lock focus.



Exposure Compensation

Exposure compensation is used to alter exposure from the value suggested by the camera to make pictures brighter or darker.

1 Press (exposure compensation).



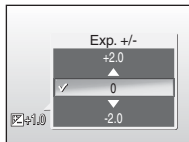

2 Press the multi selector or to adjust exposure.

- When the picture is too dark: adjust the exposure compensation to "+" side.
- When the picture is too bright: adjust the exposure compensation to "-" side.
- The monitor will return to the normal display for the current mode if the setting is not applied by pressing  within five seconds.
- Exposure compensation can be set to values between -2.0 and +2.0 EV.
- For information on using the multi selector, see "Multi Selector" ( 8).



3 Press .

- At settings other than 0, the  icon and exposure compensation are shown in the monitor.
- The exposure compensation applied in  mode is stored in the camera's memory even after the camera is turned off.



Scene Modes

The camera offers a choice of 16 “scene” options. Camera settings are automatically optimized for the selected subject type.

Scene menu

Face-priority AF	Portrait	Landscape
Sports	Night portrait	Party/indoor
Beach/snow	Sunset	Dusk/dawn
Night landscape	Close up	Museum
Fireworks show	Copy	Back light
Panorama assist	Voice recording*	

* See “Voice Recordings” (52)

Taking Pictures in Scene Modes

1 Select **SCENE** mode.

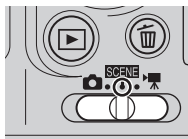

2 Press **MENU**.

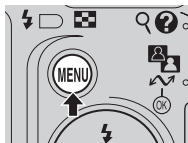

3 Press the multi selector **▲** or **▼** to choose the desired scene mode and press **OK**.

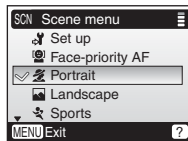

- For information on using the multi selector, see “Multi Selector” (8).



- 4** Frame the subject and take the picture.



Image Mode

The [ Image mode] ( 74) can be set other than in [Sports] in the scene menu. Changes made to the image mode setting apply to all shooting modes.

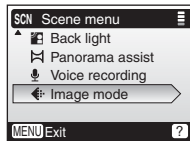

Features

Face-priority AF

Camera automatically recognizes human faces and focuses on face of portrait subject.

See “Taking Pictures in the Face-priority AF” ( 37) for more information on using this function.

- Pictures taken in “tall” orientation are displayed in the same “tall” orientation in the monitor.



¹ Other settings can be selected.

Portrait

Use this mode for portraits in which the main subject stands out clearly while background details are softened. Portrait subjects exhibit smooth, natural-looking skin tones.



¹ Other settings can be selected.

Landscape

Use this mode for vivid landscapes, cityscapes, and portraits featuring a landmark in the background.

- Camera focuses at infinity. Focus indicator ( 20) always glows green when the shutter-release button is pressed halfway; note, however, that object in foreground may not always be in focus.



¹ Other settings can be selected.

Sports

Use this mode for dynamic action shots that freeze the action in a single shot and record motion in a series of pictures.

- While the shutter-release button is held down, pictures are taken continuously at a maximum rate of about two frames per second (fps). This rate is maintained for up to five pictures.
- Camera focuses continuously even when the shutter-release button is not pressed.



¹ Other settings can be selected.

Night Portrait





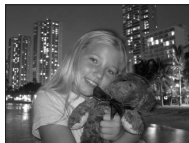

Use this mode to achieve a natural balance between the main subject and background lighting in portraits shot taken at night.



¹ Fill flash with slow sync and red-eye reduction.

² Other settings can be selected.

: For those scene modes with , use of a tripod is recommended.

: For those scene modes with , noise reduction may be automatically applied as pictures taken are recorded; results in increased recording times.

Party/indoor

Captures the effects of candlelight and other indoor background lighting.

- Hold the camera steadily to prevent camera shake.



¹ Auto with red-eye reduction. Other settings can be selected.

² Other settings can be selected.

Beach/snow

Captures the brightness of such subjects as snowfields, beaches, or sunlit expanses of water.



¹ Other settings can be selected.

Sunset

Preserves the deep hues seen in sunsets and sunrises.

- Hold the camera steadily to prevent camera shake.



¹ Other settings can be selected.

Dusk/dawn



Preserves the colors seen in the weak natural light before sunrise or after sunset.

- Camera focuses at infinity. Focus indicator ( 20) always glows green when the shutter-release button is pressed halfway; note, however, that objects in foreground may not always be in focus.



¹ Other settings can be selected.

Night landscape



Slow shutter speeds are used to produce stunning night landscapes.

- Camera focuses at infinity. Focus indicator ( 20) always glows green when the shutter-release button is pressed halfway; note, however, objects in foreground may not always be in focus.



¹ Other settings can be selected.

Close up



Photograph flowers, insects, and other small objects at close range ( 27).

- Camera focuses continuously until the shutter-release button is pressed halfway to lock focus.
- Hold the camera steadily to prevent camera shake.



¹ Other settings can be selected.

: For those scene modes with , use of a tripod is recommended.

: For those scene modes with , noise reduction may be automatically applied as pictures taken are recorded; results in increased recording times.

Museum

Use indoors where flash photography is prohibited (for example, in museums and art galleries) or in other settings in which you do not want to use the flash.

- [BSS] ( 79) turns on automatically.
- Hold the camera steadily to prevent camera shake.



¹ Other settings can be selected.

Fireworks show



Slow shutter speeds are used to capture the expanding burst of light from a firework.

- Camera focuses at infinity. Focus indicator ( 20) always glows green when the shutter-release button is pressed halfway; note, however, that objects in foreground may not always be in focus.





Copy

Provides clear pictures of text or drawings on a white board or in print.

- Use macro close-up mode ( 27) to focus at short ranges.
- Colored text and drawings may not show up well.



¹ Other settings can be selected.

: For those scene modes with , use of a tripod is recommended.

Back light

Use when light is coming from behind your portrait subject, throwing features or details into shadow. The flash fires automatically to “fill-in” (illuminate) shadows.



			Off ¹		Off		0 ¹
---	---	---	------------------	---	-----	---	----------------

¹ Other settings can be selected.

Panorama assist



Use when taking a series of pictures that will later be joined to form a single panorama using PictureProject.

See “Taking Pictures for a Panorama” ( 38) for more information on using this function.

	 ¹		Off ¹		Off ¹		0 ¹
---	--	---	------------------	---	------------------	---	----------------

¹ Other settings can be selected.

: For those scene modes with , use of a tripod is recommended.

Taking Pictures in the Face-priority AF

- 1** Press the multi selector ▲ or ▼ to choose [Face-priority AF] in the scene menu and press **OK**.

- The  guide is displayed.



- 2** Frame a picture using the  guide.

- When the camera detects a face, the guide is displayed with a double yellow border.
- When the camera detects more than one face, the closest face is framed by a double border and the rest by a single border. The camera focuses on the face framed by the double border. If the camera loses its ability to detect a face (for example, because the subject has looked away from the camera), borders are no longer displayed and monitor display returns to that shown in step 1.

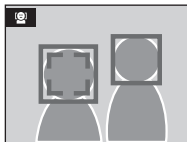

- 3** Press the shutter-release button halfway.

- Focus and exposure are set, and the double border glows green.

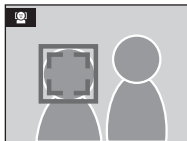

- 4** Press the shutter-release button the rest of the way down to take a picture.



✓ Face-Priority AF

- The camera's ability to detect faces depends on a variety of factors, including whether or not the subject is facing the camera.
- The camera will focus continuously until a face detected.
- If the yellow double border blinks when the shutter-release button is pressed halfway, the camera was unable to focus. Release the button and try again.
- If no face is recognized when the shutter-release button is pressed halfway, the camera focus is on the center of the frame.
- The camera may be unable to detect faces in the following situations;
 - When faces are partially hidden by sunglasses or other obstructions
 - When faces take up too much or too little of the frame

Taking Pictures for a Panorama

1 Press the multi selector ▲ or ▼ to choose [P Panorama assist] in the scene menu and press OK.

- The ▷ icon appears in yellow to indicate the panorama direction (that is, the direction in which pictures are serialized).
- For information on using the multi selector, see "Multi Selector" (8).

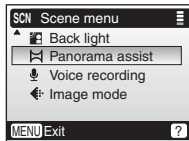

2 Press ▲, ▼, ◀, or ▶ to select the desired pan direction and press OK.

- The arrow showing the selected direction turns white.
- Before the first picture is taken, the flash mode (24), self-timer (26), macro close-up (27), and exposure compensation (28) settings can be adjusted.
- The direction can be re-selected by pressing OK again.



3 Take the first picture.

- The first picture is displayed in the first third of the monitor.



4 Take the second picture.

- Compose the next picture so that it overlaps the first picture.
- Repeat until you have taken the necessary number of pictures to complete the scene.



5 Press **OK** to finalize the series.

- Monitor display returns to that shown in step 2.



✓ Panorama Assist

Flash mode (24), self-timer (26), macro close-up (27), and exposure compensation (28) settings cannot be adjusted after the first picture is taken. Pictures cannot be deleted, nor can zoom or image-mode setting (74) be adjusted until the series is finalized.



The panorama series is terminated if the camera enters standby mode with the auto off function (97) during shooting.

AE-L









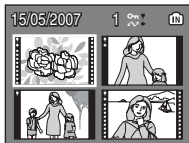





The **AE-L** icon (white) is displayed to indicate that white balance and exposure have been locked at the values set with the first shot. All pictures taken in a panorama series have the same exposure and white balance settings.



Viewing Multiple Pictures: Thumbnail Playback

Pressing  (**W**) in full-frame playback ( 22) to display pictures in "contact sheets" of four or nine thumbnail images. The following operations can be performed while thumbnails are displayed:



To	Press	Description	
Choose pictures		Press the multi selector  ,  ,  , or  to choose pictures.	8
Change number of pictures displayed		With four thumbnails displayed, press  (W) to view nine thumbnails. With nine thumbnails displayed, press  (T) to display four thumbnails. With four thumbnails displayed, press  (T) to return to full-frame playback.	–
Cancel thumbnail playback		Cancel thumbnail playback and return to full-frame playback.	–
Switch to shooting mode	 	Press  or the shutter-release button to switch to the shooting mode selected with the mode selector.	22

Thumbnail Playback Display

When protected pictures and pictures selected for transfer are displayed in thumbnail playback, the icons shown at right are displayed with them. Movies are displayed as film frames.

: Protect icon
: Transfer icon









Film frames

Taking a Closer Look: Playback Zoom

Press **Q (T)** to zoom in on still images displayed in full-frame playback ( 22). Playback zoom is not available when the current picture is a movie or a copy created using the small picture option. The playback zoom ratio is displayed in the monitor while the picture is zoomed in, and the following operations can be performed:



To	Press	Description	
Zoom in	Q (T)	Zoom increases each time Q (T) is pressed, to a maximum of 10×. While the image is zoomed in, the zoom ratio is displayed in the top left corner of the monitor.	–
Zoom out	 (W)	Zoom decreases each time  (W) is pressed.	–
View other areas of picture		Use the multi selector to scroll to areas of picture not visible in the monitor. To use the multi selector to view other pictures, cancel playback zoom.	44
Return to full-frame playback	OK	Cancel playback zoom and return to full-frame playback.	–
Crop picture	MENU	Crop current picture to contain only the portion visible in the monitor.	44
Switch to shooting mode	 	Press  or the shutter-release button to switch to the shooting mode selected with the mode selector.	22

Enlarging Pictures

Pictures taken in “tall” orientation in face-priority AF scene mode are not displayed in “tall” orientation when the view of the picture is enlarged with playback zoom.

Playback Menu

Cancel playback zoom then press **MENU** to display the playback menu.

Editing Pictures

Use the COOLPIX L11/COOLPIX L10 to edit pictures in-camera and store them as separate files (📷 103). The editing features described below are available.

Editing function	Description
D-Lighting	Create a copy of the current picture with enhanced brightness and contrast, brightening dark portions of the picture.
Crop	Enlarge the image or refine the composition and create a copy containing only the portion visible in the monitor.
Small picture	Create a small copy of pictures suitable for use on web pages or as e-mail attachments.

Picture Editing

- Editing functions may not be available for pictures taken with another make or model of digital camera.
- It may not be possible to view copies created with your camera on another make or model of digital camera, or to transfer them from another make or model of digital camera to a computer.
- Editing functions are not available when there is not enough free space in the internal memory or on the memory card.

Restrictions on Picture Editing

(✓: available, -: not available)

1st editing	2nd editing		
	D-Lighting	Crop	Small picture
D-Lighting	–	✓	✓
Crop	–	–	–
Small picture	–	–	–



- Pictures cannot be edited twice with the same editing function.
- The D-Lighting should be done first while the restricted use of combination exists.

Original Pictures and Edited Pictures

- Copies created with editing functions are not deleted if the original pictures are deleted. The original pictures are not deleted if copies created with editing functions are deleted.
- Edited copies are stored with the same recording date and time as the original.
- Copies created using crop, D-Lighting, and small picture have the same transfer marking (📷 85) as the original but are not marked for printing (📷 69) or protecting (📷 84).

Enhancing Brightness and Contrast: D-Lighting



D-Lighting can be used to create copies, with enhanced brightness and contrast, of pictures affected by backlighting or insufficient flash lighting.

1 Press  (OK) in full-frame playback ( 22).

- The original picture is displayed at left and the picture applied with D-lighting enhancement is displayed at right.



2 Press  or  to choose [OK] and press .

- A new copy with enhanced brightness and contrast is created.
- To exit without creating a new copy, choose [Cancel] and press .
- For information on using the multi selector, see "Multi Selector" ( 8).
- D-Lighting copies can be recognized by the  icon displayed during playback.

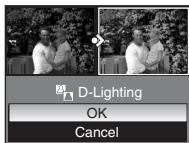

Creating a Cropped Copy: Crop

If the **MENU** icon is displayed in the monitor with playback zoom enabled (41), the portion of the picture currently visible in the monitor can be saved as a separate file.

- 1 Press **Q** (**T**) to zoom in on the image in full-frame playback (22).



- 2 Adjust display so that only the portion of the picture to be saved is shown.

- Press **Q** (**T**) or **W** to adjust the zoom ratio.
- Press the multi selector **▲**, **▼**, **◀**, or **▶** to scroll to areas of the picture not currently visible in the monitor.
- For information on using the multi selector, see "Multi Selector" (8).

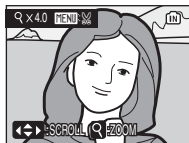

- 3 Press **MENU**.

- The confirmation dialog will be displayed.

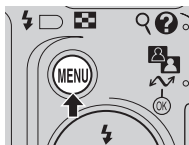

- 4 Press **▲** or **▼** to choose [Yes] and press **OK**.

- A new picture, containing only the area visible in the monitor, is created.





Image Mode Cropped Copy Image Mode

Depending on the size of the original picture and the zoom ratio in effect at the time the copy was created, the camera will automatically select one of the following image-mode settings for cropped copies. (Unit: pixel)

- **SM** 2,592 × 1,944 (L11 only)
- **LM** 2,272 × 1,704
- **3M** 2,048 × 1,536
- **2M** 1,600 × 1,200
- **1M** 1,280 × 960
- **PC** 1,024 × 768
- **TV** 640 × 480
- **□** 320 × 240
- **□** 160 × 120

Resizing Pictures: Small Picture

Create a small copy of the current picture. Copies are stored as JPEG files with compression ratio of 1 : 16. Choose from the following sizes:

Option	Description
 640×480	Suited to television playback.
 320×240	Suited to display on web pages.
 160×120	Suitable for e-mail attachments.

- 1 Display the desired picture in full-frame playback mode ( 22) and press **MENU**.

- The playback menu is displayed.

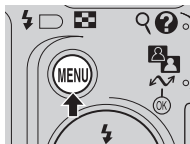

- 2 Press the multi selector **▲** or **▼** to choose [Small pic.] and press **OK**.

- The small picture options are displayed.
- For information on using the multi selector, see "Multi Selector" ( 8).

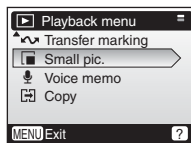

- 3 Press **▲** or **▼** to choose the desired copy size and press **OK**.

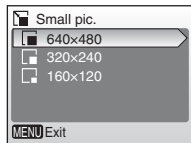

- The confirmation dialog will be displayed.
- To exit without creating a new copy, press **MENU**.

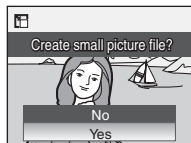

- 4 Press **▲** or **▼** to choose [Yes] and press **OK**.

- A small picture copy is created at the chosen size.



Small copies are recognized by their gray border and the , , or  icon displayed during playback.

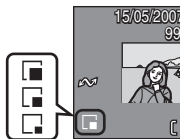

Voice Memos: Recording and Playback

The camera's built-in microphone can be used to record voice memos for pictures in full-frame playback (📷 22) or thumbnail playback (📷 40).

Recording Voice Memos

- 1 Display the desired picture in full-frame playback, or select it with thumbnail playback, and press **MENU**.
 - The playback menu is displayed.

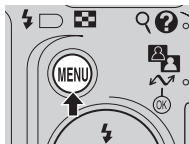

- 2 Press the multi selector ▲ or ▼ to choose [Voice memo] and press **OK**.
 - For information on using the multi selector, see "Multi Selector" (📷 8).

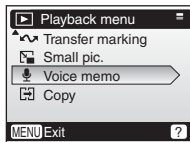

- 3 Press and hold **OK** to record a voice memo.

- Recording ends after 20 seconds or when **OK** is released.
- Do not touch the built-in microphone during recording.
- During recording, **REC** and [♪] blink in the monitor.
- Press ◀ to return to the playback menu without recording a voice memo.
- The voice memo playback display appears when **OK** is released. Proceed to step 3 in the section, "Playing Voice Memos" (📷 47), to listen to the voice memo immediately.

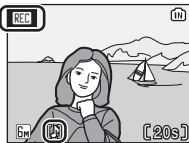

Playing Voice Memos

- 1** Display a picture with an attached voice memo in full-frame playback, and select it with thumbnail playback, and press **MENU**.

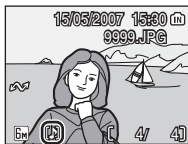
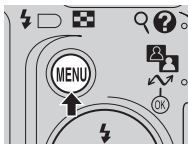

- Pictures with voice memos are indicated by the icons.
- The playback menu is displayed.

- 2** Press the multi selector **▲** or **▼** to choose [Voice memo] and press **OK**.

- For information on using the multi selector, see "Multi Selector" (8).

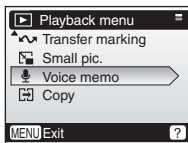

- 3** Press **OK** to listen to the voice memo.

- Playback ends when the voice memo ends or **OK** is pressed again.
- Press **W** () or **T** () to adjust the volume.
- Press **◀** to return to the playback menu without listening to a voice memo.

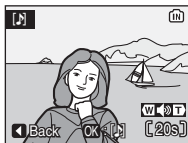

Deleting Voice Memos

Select a picture with a recorded voice memo and press . Choose and press **OK** to delete the voice memo only. Choose [Yes] to delete both the picture and its voice memo.

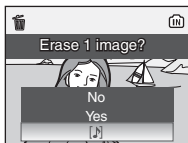
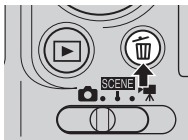

Voice Memos

- Voice memo file names are the same as those of the images they attach to except that the extension is ".WAV", e.g., "DSCN0015.WAV" (103).
- If a voice memo already exists for the current picture, it must be deleted before a new voice memo can be recorded.
- A voice memo may not be able to be attached to pictures recorded by another make or model of digital camera.

Recording Movies

Follow the instructions below to shoot movies with sound recorded via the built-in microphone.

1 Select mode.

- The maximum length of the movie that can be recorded is displayed in the monitor.

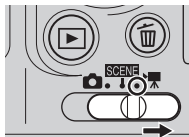



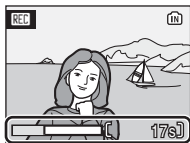

2 Press the shutter-release button to start recording.

- A progress bar at the bottom of the monitor shows the amount of recording time remaining.
- To end recording, press the shutter-release button again.
- Recording will end automatically when the internal memory or memory card is full.



Recording Movies

- The flash (, 24), self-timer (, 26), and exposure compensation feature (, 28) are not available in movie mode. Macro close-up (, 27) can be used when applied before movies are recorded.
- Digital zoom (up to 2×) can be applied while movies are being recorded. Adjust zoom before beginning recording. Once recording begins, optical zoom cannot be adjusted.





Settings for Movie Mode

A number of recording options are available for movie mode. (, 49, 50).

The Movie Menu

Movie Options

The movie menu offers the options shown below.

Option	Image size and frame rate	Maximum movie length ¹	
		Internal memory (7 MB)	Memory card (256 MB)
 TV movie 640★	Image size: 640 × 480 pixels Frame rate: 30 frames per second	7 sec.	4 min. 50 sec. ²
 TV movie 640	Image size: 640 × 480 pixels Frame rate: 15 frames per second	11 sec.	7 min.
 Small size 320★	Image size: 320 × 240 pixels Frame rate: 30 frames per second	20 sec.	13 min. 20 sec.
 Smaller size 320 (default setting)	Image size: 320 × 240 pixels Frame rate: 15 frames per second	40 sec.	25 min. 55 sec.
 Smaller size 160	Image size: 160 × 120 pixels Frame rate: 15 frames per second	2 min. 2 sec.	1 h 18 min. 25 sec.

¹ Movies can be as long as free space in the internal memory or on the memory card allows. All figures are approximate. Maximum movie length or frames varies with make of memory card.

² To prevent **TV movie 640★** from ending unexpectedly, use card rated for more than 10 MB/s.

Movie File and Folder Names

See "Image/Sound File and Folder Names" ( 103).

Applying Movie Setting

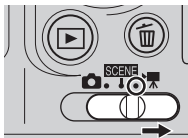

1 Select  mode.



2 Press **MENU**.

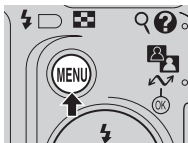

- The movie menu is displayed.

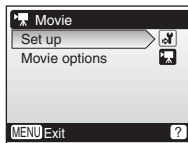

3 Press the multi selector  or  to choose [Movie options] and press **OK**.

- The movie options are displayed.
- For information on using the multi selector, see "Multi Selector" ( 8).



4 Press  or  to choose the desired setting and press **OK**.

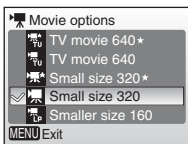

- The setting is enabled and the movie menu is displayed.
- To exit without applying the setting, press **MENU**.









Auto-Focus Mode

The Camera focuses when the shutter-release button is pressed halfway and locks at this position during recording.

Movie Playback

In full-frame playback (F22) or thumbnail playback (F40), movies are recognized by the  icon. To play a movie, display it in full-frame playback and press .

Use **W** ()/**T** () to adjust playback volume. Playback controls are displayed at the top of the monitor. Press the multi selector  or  to choose a control, then press  to perform the selected operation.



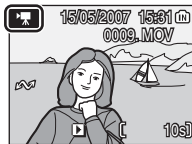



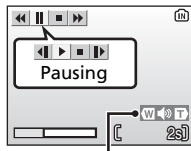

For information on using the multi selector, see “Multi Selector” ( 8).



Playback display





Volume indicator

To	Press	Description
Rewind		Movie rewinds while  is pressed.
Fast forward		Movie advances while  is pressed.
Pause		Pause playback. The following operations can be performed while playback is paused.
		 Rewind movie by one frame.
		 Advance movie by one frame.
		 Resume playback.
Stop		Stop playback and return to full-frame playback.

Deleting Movie Files

Display a movie in full-frame playback (F22) or thumbnail playback (F40) and press .

A confirmation dialog is displayed. Choose [Yes] and press  to delete the movie, or choose [No] and press  to return to the normal playback display without deleting the movie.



Making Voice Recordings

Voice recordings of about 15 minutes in the memory or up to five hours on the memory card (256 MB or more) are available.

1 Select **SCENE** mode.

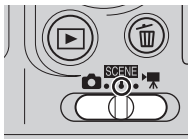

2 Press **MENU** to display the scene menu.

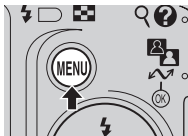

3 Press the multi selector **▲** or **▼** to choose [Voice recording] and press **OK**.

- The date and the maximum length of the voice recording that can be made are displayed in the monitor.
- For information on using the multi selector, see "Multi Selector" (8).

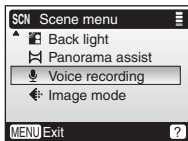

4 Press the shutter-release button to start voice recording.

- To pause recording, press **OK**. Press again to resume recording. The indicator lamp is lit during recording, and blinks in recording pause mode.
- To end recording, press the shutter-release button again.
- Recording will end automatically if the internal memory or memory card becomes full, or after five hours of recording on the memory card (256 MB or more).

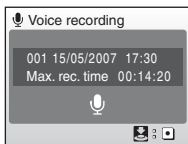

Recording indicator

File number

Length of recording

Progress indicator

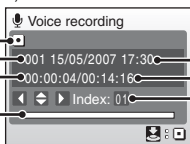

Date of recording

Time remaining

Index number

✔ Notes on Voice Recording

- Do not touch the microphone during voice recording.
- Voice recording is not possible if the internal memory/memory card has less than ten seconds of recording time available, or the battery charge is insufficient.
- It is recommended to use the AC Adapter EH-65A (available separately from Nikon) for extended recording.
- Test recording beforehand, to ensure proper function, is advised.

✍ Monitor During Voice Recordings

If no operations are performed for 30 seconds, the monitor will turn off automatically to save power.

The following operations are available while the monitor is off.

- Press the multi selector ▲, ▼, ◀, or ▶ to add index.
- Press ⓧ to pause or resume voice recording.
- Press the shutter-release button to end voice recording.

Press the shutter-release button halfway to display the monitor.

✍ Sound File

See “Image/Sound File and Folder Names” (📖 103) for the file and folder names of voice recordings.

🔍 Adding an Index

An index can be added by pressing the multi selector ▲, ▼, ◀, or ▶ during recording. The camera can locate the index during playback and begin playback from this point. The start is assigned an index of one; other indices are assigned in ascending order, to a maximum of 98. The current index number is shown in the monitor.

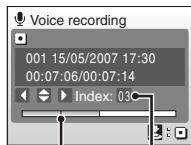

Index number
Index markers

🔍 Exiting Voice Recording

Set the mode selector to the desired mode.

Playing Voice Recordings

1 Press the multi selector ▲ or ▼ to choose [Voice recording] in the scene menu and press OK.

- The voice recording screen is displayed.
- For information on using the multi selector, see "Multi Selector" (8).

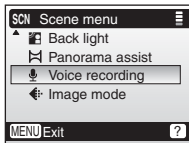

2 Press ▶.

- Currently saved voice recordings are listed.

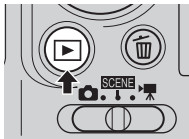







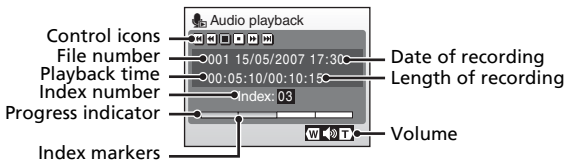
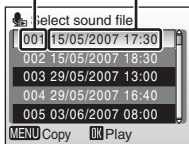

3 Press ▲ or ▼ to choose the desired voice recording and press OK.

- The voice recording playback screen is displayed and playback starts.
- Index markers show the index position added during recording.

Date of recording
File number



Volume can be adjusted with **W** (⏮)/**T** (⏭) during playback. Playback controls are displayed at the top of the monitor. Press ◀ or ▶ to choose a control, then press **OK** to perform the selected operation.

To	Press	Description
Pause playback		Press OK to pause playback.
Resume playback		When playback is paused, use multi selector to select  icon, then press OK .
Rewind		Press and hold OK .
Fast forward		Press and hold OK .
Index return		Press OK to return to start of current index.
Index skip		Press OK to skip to next index.
Stop playback*		Press OK to return to voice recording list.

* Playback can also be stopped by pressing  on the camera.

Copying Voice Recordings to a Computer

Voice recordings cannot be copied to a computer using PictureProject. Set the USB option in the setup menu [Interface] to [Mass storage] ( 99) and copy the files directly from the camera. Once copied to a computer, voice recordings can be played back with a player that supports WAV format files (such as QuickTime). Indices added during recording work only when playing back on the camera.

Returning to the Voice Recording Mode

Press  on the voice recording list screen to return to the voice recording mode.

Deleting Voice Recordings

To delete a voice recording, press  during playback or while the recording is highlighted in the voice recording list screen. A confirmation dialog will be displayed. Choose [Yes] and press **OK** to delete the recording and return to the voice recording list screen, or choose [No] and press **OK** to return to the voice recording list screen without deleting recording.

Exiting Voice Recording

Set the mode selector to the desired mode.

Copying Voice Recordings



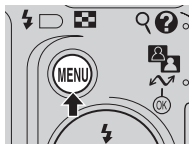

Copy voice recordings between the internal memory and a memory card. This option is available only when a memory card is inserted.

1 Press **MENU** on the voice recording list screen. (☒ 54, step3)

- When  is pressed to display the voice recording list (☒ 54, step2) without a sound file stored on the memory card, the message, [No sound file.], is displayed. Press **MENU** to display the copy sound files screen, and copy the sound files stored in the camera's internal memory to the memory card.



2 Press the multi selector **▲** or **▼** to select the copy direction and press **OK**.

-  → : from internal memory to a memory card
-  → : from a memory card to internal memory
- For information on using the multi selector, see "Multi Selector" (☒ 8).

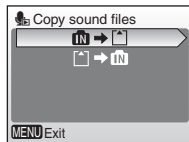

3 Press **▲** or **▼** to select the copy mode and press **OK**.

- [Selected files]: Proceed to step 4.
- [Copy all files]: Proceed to step6.

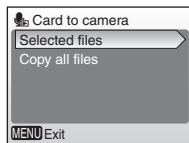

4 Choose the desired file.

- Press the multi selector **▶** to select the file (✓). Press the multi selector **▶** again to cancel the selection.
- Multiple files can be selected.
- Press **OK** to finalize file selection.
- A confirmation dialog will be displayed.

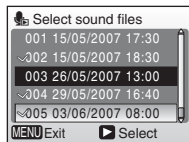

5 Press **OK**.

6 Press **▲** or **▼** to choose [Yes] and press **OK**.

Copying starts.

Copy

Voice recordings made with another make of camera cannot be copied.

You can connect your camera to your television, computer, or printer to view pictures you have taken.

Connecting to a TV (📺 58)

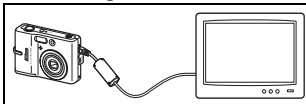

View pictures on a TV by connecting the camera via the Audio/Video Cable EG-CP14, supplied with the L11 or available separately for the L10.

Connecting to a Computer (💻 59)

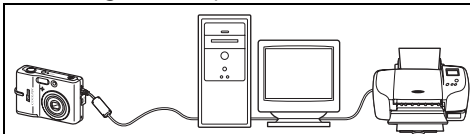

Use the supplied PictureProject software to copy pictures to a computer, and then organize, browse, edit, and save those pictures. Connect the camera to the computer using the supplied USB cable. You can also print pictures from a printer connected to the computer using PictureProject installed in the computer.

Connecting to a Printer (🖨️ 63)

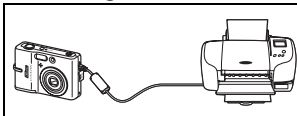

Connect your camera directly to a Pict-Bridge-compatible printer. Use the supplied USB cable to connect the camera to a printer for direct printing.

✔ Before Connecting the Camera

Use fresh batteries or the AC Adapter EH-65A (available separately from Nikon) to prevent the camera from turning off unexpectedly while connected.

🔪 Playback, Transfer, or Print Pictures from Internal Memory

To view pictures stored in the camera's internal memory on a TV, or to transfer them to a computer or print with direct connection to a printer, remove the memory card from the camera.

🖨️ Printing Pictures

In addition to printing pictures transferred to a computer from your personal printer and printing over a direct camera-to-printer connection, the following options are also available for printing pictures:

- Insert a memory card into a DPOF-compatible printer's card slot
- Take a memory card to a digital photo lab

For printing using these methods, specify the pictures and the number of prints each using your camera's [Print set] menu (📷 69).

Connecting to a TV

Connect the camera to a television using the audio/video (A/V) cable to play back pictures on the television.

1 Turn the camera off.

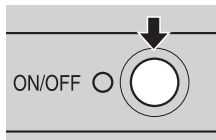

2 Connect the A/V cable.

- Connect the yellow plug to the video-in jack on the TV, and the white plug to the audio-in jack.

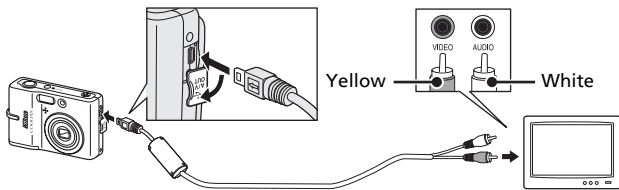

3 Tune the television to the video channel.

- See the documentation provided with your television for details.

4 Press for one second to turn the camera on.

- The camera monitor will remain off and the image normally shown in the monitor will be displayed on the television.

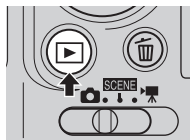

Connecting the A/V Cable

- When connecting the A/V cable, be sure that the camera connector is oriented correctly. Do not use force when connecting the A/V cable to the camera. When disconnecting the A/V cable, do not pull the connector at an angle.
- Do not pinch the connector cover between the camera's A/V connector and the A/V cable connector when connecting the cable to the camera.

Video Mode

Be sure that the camera's video mode setting conforms to the standard used by your television. The video mode setting is an option in the [Interface] (89) item in the setup menu (87).

Connecting to a Computer

Use the USB cable to connect the camera to a computer, and copy (transfer) pictures to a computer with the supplied PictureProject software.

Before Connecting the Camera

Installing PictureProject

Before transferring pictures or movies to a computer, PictureProject must be installed. For more information on installing and using PictureProject, see the *Quick Start Guide*.

Confirming USB Option

The following two methods can be used to transfer pictures from the camera to a computer:



- Press  (OK) on the camera.
- Click [Transfer] in PictureProject.

The method used will depend on your computer's operating system and the USB option selected in the camera's setup menu.

Operating system ¹	USB option ²	
	 (OK) on the camera ³	[Transfer] in PictureProject
Windows Vista (32-bit Home-Basic/HomePremium/Business/Enterprise/Ultimate editions)	Choose [Mass storage].	Choose [Mass storage] or [PTP].
Windows XP Home Edition Windows XP Professional	Choose [Mass storage] or [PTP].	
Windows 2000 Professional ⁴	Choose [Mass storage].	
Mac OS X (10.3.9, 10.4.x)	Choose [PTP].	Choose [Mass storage] or [PTP].

¹ Refer to the Nikon website for the latest information on operating system compatibility.

² This camera supports the USB options, [Mass storage] and [PTP] (default setting).

³ The camera's  (OK) button cannot be used to transfer pictures when the memory card write-protect switch is in the "lock" position. Use [Transfer] in PictureProject. To use  (OK) on the camera, unlock by sliding the switch to the "write" position before transferring pictures.

⁴ If your computer is running Windows 2000 Professional, be sure to set the USB option to [Mass storage]. If [PTP] is selected, the Found New Hardware Wizard will be displayed when the camera is connected to the computer. Select [Cancel], close the window, and disconnect the camera from the computer.

Setting the USB Option

Set the USB option (🔌 99) in the setup menu on the camera before connecting the camera to the computer or printer.

1 Press MENU.

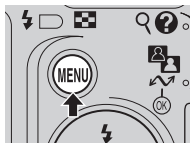

2 Press the multi selector ▲ or ▼ to choose [Set up] and press OK.

- The setup menu is displayed.
- For information on using the multi selector, see "Multi Selector" (🔍 8).

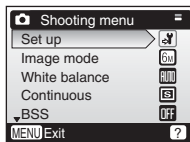

3 Press ▲ or ▼ to choose [Interface] and press OK.

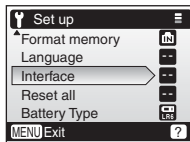

4 Press ▲ or ▼ to choose [USB] and press OK.

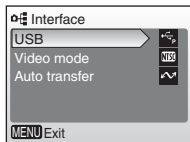

5 Press ▲ or ▼ to choose [PTP] or [Mass storage] and press OK.

- The setting is enabled.
- To finish setting, press MENU.

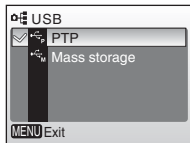

Transferring Pictures to a Computer

- 1 Turn on a computer to which PictureProject has been installed.
- 2 Turn the camera off and connect the USB cable as shown below.

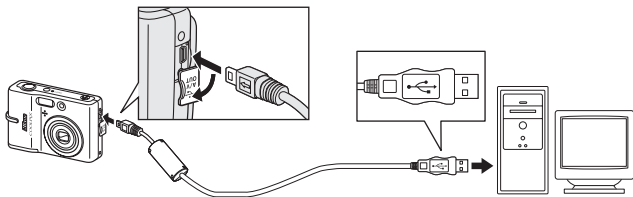

- 3 Turn the camera on.
 - At default PictureProject settings, PictureProject Transfer is launched immediately with recognition of camera connection.

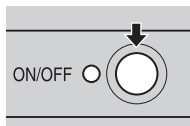



- 4 Transfer pictures and movies.

- **Transfer using PictureProject**

While PictureProject Transfer is launched, click [Transfer] of PictureProject Transfer.

All pictures and movies marked for transfer are copied to the computer. Once transfer is complete, pictures are displayed in PictureProject.

- **Transfer using  (OK) on the camera**

While PictureProject Transfer is launched, press  (OK) on the camera to copy pictures marked for transfer ( 62) to the computer. The following messages are displayed in the camera monitor during transfer.

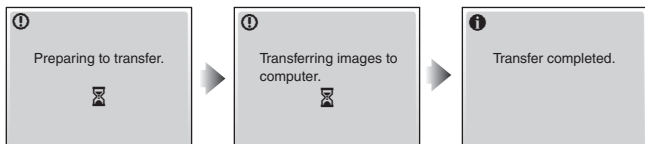

✓ Connecting the USB Cable

- When connecting the USB cable, be sure that the connectors are oriented correctly. Do not use force when connecting the USB cable. When disconnecting the USB cable, do not pull the connector at an angle.
- Do not pinch the connector cover between the camera's USB connector and the USB cable connector when connecting the cable to the camera.
- Connection may not be recognized when the camera is connected to a computer via a USB hub.

5 Disconnect the camera when transfer is complete.

• If the USB option is set to [PTP]

Turn the camera off and disconnect the USB cable.

• If the USB option is set to [Mass storage]

Remove the camera from the system as described below before turning the camera off and disconnecting the USB cable.

Windows Vista/XP Home Edition/XP Professional

Click the [Safely Remove Hardware] icon () in the taskbar and select [Safely remove USB Mass Storage Device] from the menu displayed.



Windows 2000 Professional

Click the [Unplug or Eject Hardware] icon () in the taskbar and select [Stop USB Mass Storage Device] from the menu displayed.





Macintosh

Drag the untitled camera volume ("NO NAME") to the Trash.



✍ Marking Pictures for Transfer

Pictures marked for transfer are recognized by the  icon displayed during playback. By default, all pictures are automatically marked for transfer. Two options control transfer marking:

- [Interface]>[Auto transfer] in the setup menu: Choose [On] to mark **all new pictures** for transfer ( 99).
- [Transfer marking] in the playback menu: Change marking for **existing pictures** ( 85).

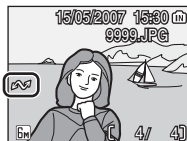

Connecting to a Printer

Users of PictBridge-compatible (📷 120) printers can connect the camera directly to the printer and print pictures without using a computer.

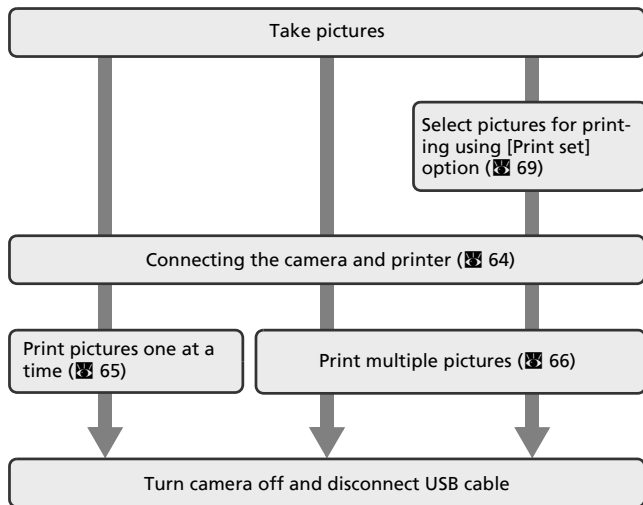

Connecting the Camera and Printer

- 1 Set the USB option ( 60) to [PTP].

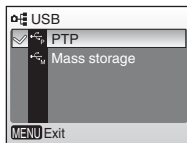

- 2 Turn the camera off.

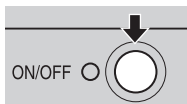

- 3 Turn the printer on.
 - Check printer settings.

- 4 Connect the USB cable as shown below.

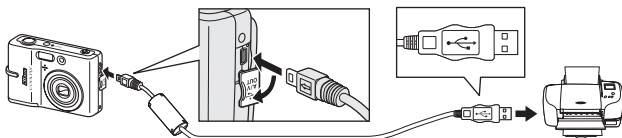

- 5 Turn the camera on.
 - The PictBridge start-up screen (①) will be displayed in the camera monitor. Then the print selection screen will be displayed (②).

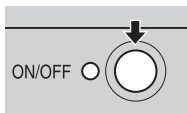

①



②

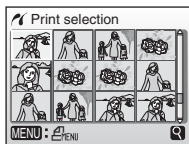

Connecting the USB Cable

- When connecting the USB cable, be sure that the connectors are oriented correctly. Do not use force when connecting the USB cable. When disconnecting the USB cable, do not pull the connector at an angle.
- Do not pinch the connector cover between the camera's USB connector and the USB cable connector when connecting the cable to the camera.

Printing Pictures One at a Time

After connecting the camera to the printer correctly (64), print pictures by following the procedure below.

1 Press the multi selector ◀ or ▶ to choose the desired picture and press **OK**.

- The [PictBridge] menu is displayed.
- Press **T** (Q) to switch to full-frame playback. Press **W** (8) to switch back to thumbnail display.
- For information on using the multi selector, see “Multi Selector” (8).

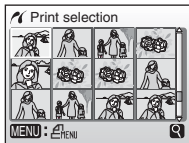

2 Press ▲ or ▼ to choose [Copies] and press **OK**.

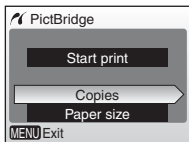

3 Press ▲ or ▼ to choose the number of copies (up to 9) and press **OK**.

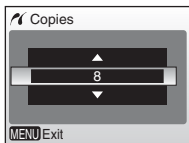

4 Press ▲ or ▼ to choose [Paper size] and press **OK**.

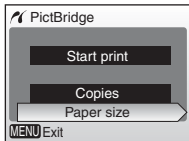

5 Press ▲ or ▼ to choose the desired paper size and press **OK**.

- To specify paper size using printer settings, choose [Default] in the paper size menu and press **OK**.

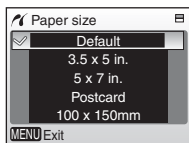

6 Press ▲ or ▼ to choose [Start print] and press **OK**.

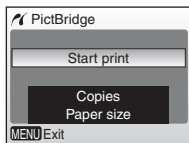

7 Printing starts.

- Monitor display returns to that shown in step 1 when printing is complete.
- Press **OK** to terminate printing before printing is complete.

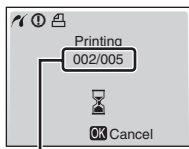

Current print/
total number of prints

Printing Multiple Pictures

After connecting the camera to the printer correctly (64), print pictures by following the procedure below.

1 When the print selection screen is displayed, press **MENU**.

- The print menu is displayed.

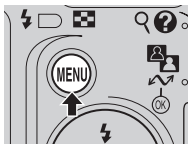

2 Press the multi selector ▲ or ▼ to choose [Paper size] and press **OK**.

- For information on using the multi selector, see "Multi Selector" (8).

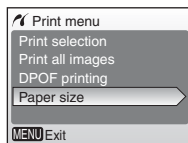

3 Press ▲ or ▼ to choose the desired paper size and press **OK**.

- To specify paper size using printer settings, choose [Default] in the paper size menu and press **OK**.

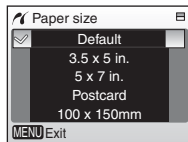

4 Press ▲ or ▼ to choose [Print selection], [Print all images] or [DPOF printing] and press **OK**.

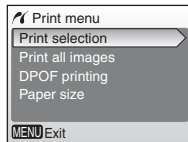

Print selection

Choose the pictures and number of copies (up to 9) of each and press **OK**.

- Press ◀ or ▶ to select pictures and ▲ or ▼ to set the number of copies for each.

Pictures selected for printing can be recognized by the check mark (✓) and the numeral indicating the number of copies to be printed. A check mark is not displayed with pictures for which 0 copies have been specified and these pictures will not be printed.

- Press **T** (Q) to switch to full-frame playback. Press **W** (Q) to switch back to thumbnail display.
- Press **OK** when setting is complete.

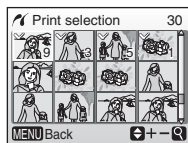

Print all images

All pictures stored in the internal memory or memory card are printed.

DPOF printing

Pictures for which a print order has been created are printed accordingly (▶ 69).

- The options for DPOF printing are displayed.
- To print, press ▲ or ▼ to choose [Start print] and press **OK**.
- To view the current print order, choose [View images] and press **OK**. Print order details will be displayed.
- Press **MENU** to modify the selection and return to the print selection screen.

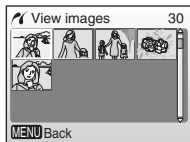
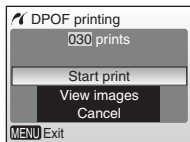

5 Printing starts.

- Monitor display returns to the [Print menu] (step 2) when printing is complete.
- Press **OK** to terminate printing before it is complete.

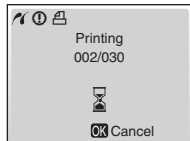

Paper Size

The camera supports the following paper sizes: [Default] (the default paper size for the current printer), [3.5 x 5 in.], [5 x 7 in.], [Postcard], [100 x 150 mm], [4 x 6 in.], [8 x 10 in.], [Letter], [A3], and [A4]. Only sizes supported by the current printer will be displayed.

Creating a DPOF Print Order: Print Set

The [Print set] option in the playback menu is used to create digital “print orders” for printing on DPOF-compatible devices (📷 120) or at a digital photo lab that supports DPOF.

In addition to pictures themselves, shooting date and photo information (shutter speed and aperture) can also be printed.

When the camera is connected to a PictBridge-compatible printer, pictures can be printed from the printer according to the DPOF print order you have created for pictures on the memory card. If the memory card is removed from the camera, you can create the DPOF print order for pictures in the internal memory and print pictures according to the DPOF print order.

1 Press MENU in playback mode.

- The playback menu is displayed.
- When printing from a PictBridge-compatible printer, create print orders before connecting the camera to the printer.

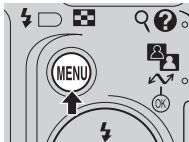

2 Press the multi selector ▲ or ▼ to choose [Print set] and press OK.

- The [Print set] menu is displayed.
- For information on using the multi selector, see “Multi Selector” (📷 8).

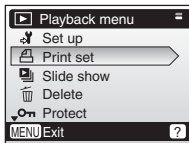

3 Press ▲ or ▼ to choose [Print selected] and press OK.

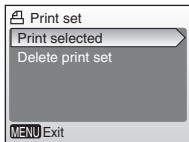

4 Choose the pictures and number of copies (up to 9) of each and press **OK**.

- Press **◀** or **▶** to select pictures and **▲** or **▼** to set the number of copies for each. Pictures selected for printing can be recognized by the check mark (✓) and the numeral indicating the number of copies to be printed. A check mark is not displayed with pictures for which 0 copies have been specified and these pictures will not be printed.
- Press **T** (Q) to switch to full-frame playback. Press **W** (⊞) to switch back to thumbnail display.
- Press **OK** when setting is complete.

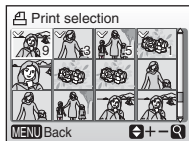

5 Set the date and info options.

Press **▲** or **▼** to choose an option, and press **OK** to turn ✓ on and enable that option. To turn ✓ off, press **OK** again.

- [Date]: Print the date of recording on all pictures in print order.
- [Info]: Print shutter speed and aperture on all pictures in the print order. Note that this information is not printed with direct connection to a printer (⊞ 64).
- [Done]: Complete the print order and exit.

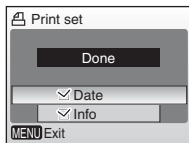

Pictures selected for printing are recognized by the  icon displayed with playback.

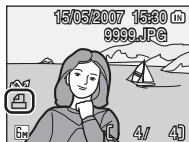

Print Set

[Date] and [Info] are reset each time the print set menu (step 4) is displayed. Information normally printed when [Info] is selected in the print set menu is not printed when the camera is connected directly to the printer.

DPOF Print Order



To delete current print order, choose [Delete print set] in the print set menu (step 3) and press **OK**.

Notes on the Print Set [Date] Option

The date and time printed on pictures with DPOF printing when [Date] in the print set menu is enabled are those recorded with the picture when it was taken. Date and time printed using this option are not affected when the camera's date and time setting are changed from the setup menu after pictures are recorded.



Differences Between Print Set and Date Imprint

Date and time can only be printed on pictures using the [Date] option in the print set menu when pictures are printed from a DPOF-compatible printer ( 120). Use the [Date imprint] ( 94) option in the setup menu to print the date on pictures from a printer that does not support DPOF (position of the date is fixed at the bottom right hand corner of the picture). Once the [Date imprint] option is enabled, the date forms a permanent part of the image and cannot be deleted from pictures.

When the date option for both [Print set] and [Date imprint] is enabled, only the date from the [Date imprint] option is printed, even when a DPOF-compatible printer is used.

Connecting to an ImageLink-compatible Printer

See documentation provided with your printer for information on how to operate the printer. This function is available for COOLPIX L11.

- 1 Attach the Dock Insert PV-14 (supplied) to the printer.

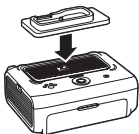

- 2 Set the USB option (60) to [PTP].

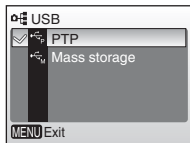

- 3 Turn the camera off and attach it to the dock insert.

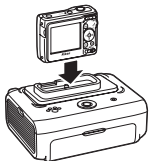

- 4 Print pictures.

- Follow the procedures described in the printer manual.

Removing the Dock Insert

Place your thumbs where indicated, press, and lift.

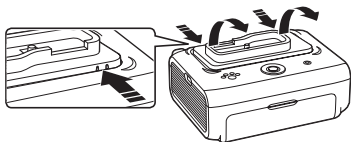













✓ Note on Connecting to an ImageLink-compatible Printer

The monitor will dim automatically if no operations are performed for about one minute while the camera is connected to an ImageLink printer. The camera will turn off if no operations are performed for another seven minutes.

Shooting Options: The Shooting Menu

The following options are available in the shooting menu.

	Set up	 87
	Display the setup menu.	
	Image mode	 74
	Choose image size and quality.	
	White balance*	 76
	Match white balance to the light source.	
	Continuous*	 78
	Take pictures one at a time or in a sequence.	
	BSS*	 79
	Use the “best shot selector” to choose the sharpest picture.	
	Color Options*	 79
	Apply color effects to pictures as they are recorded.	

* See the information on restrictions that may apply to [White balance], [Continuous], [BSS], and [Color Options] settings ( 80).

Displaying the Shooting Menu

Set the mode selector to  (auto) and press **MENU** to display the shooting menu.

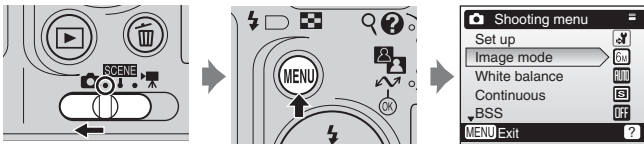





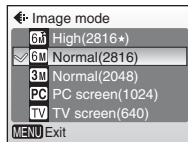

- To choose menus and apply selection, use the multi selector ( 8).
- To exit the shooting menu, press **MENU** again.

Image Mode

Pictures taken with a digital camera are recorded as image files. The size of the files, and the number of images that can be recorded with it, depend on the size and quality of the images. Before shooting, choose an image mode according to how you plan to use the picture.



Option	Size (pixels)	Description
 High (2816★) (L11 only)	2,816 × 2,112	Highest quality, suitable for enlargements or high-quality prints.
 High (2560★) (L10 only)	2,560 × 1,920	
 Normal (2816) ¹ (L11 only)	2,816 × 2,112	Best choice in most situations.
 Normal (2560) ² (L10 only)	2,560 × 1,920	
 Normal (2048)	2,048 × 1,536	Smaller size allows more pictures to be stored.
 PC screen (1024)	1,024 × 768	Suited to display on computer display.
 TV screen (640)	640 × 480	Suited to full-screen display on a television or distribution by e-mail or the web.

¹ Default setting for L11

² Default setting for L10









The icon for the current setting is displayed in the monitor ( 6, 7).

Image Mode and the Number of Exposures Remaining

The following table lists the number of pictures that can be stored in internal memory and on a 256 MB memory card, and the size of still pictures with it.

Image mode	Internal memory (7 MB)	Memory card ¹ (256 MB)	Print size ² (300 dpi; cm/in.)
 High (2816★) (L11 only)	2	80	24×18/9.4×7.1
 Normal (2816) (L11 only)	5	160	24×18/9.4×7.1
 High (2560★) (L10 only)	3	95	22×16/8.5×6.4
 Normal (2560) (L10 only)	6	190	22×16/8.5×6.4
 Normal (2048)	9	290	17×13/6.7×5
 PC screen (1024)	33	1035	9×7/3.5×2.5
 TV screen (640)	62	1940	5×4/2×1.5

¹ All figures are approximate. If the number of exposures remaining is 10,000 or more, the number of exposure remaining display shows [9999].

² All figures are approximate. The size of images when printed depends on the printer resolution: the higher the resolution, the smaller the final print size.

Image Mode

The image mode setting can also be applied from the scene menu. Changes made to the image mode setting from any of the two menus apply to all shooting modes.

WB White Balance

The color of light reflected from an object varies with the color of the light source. The human brain is able to adapt to changes in the color of the light source, with the result that white objects appear white whether seen in the shade, direct sunlight, or under incandescent lighting. Digital cameras can mimic this adjustment by processing images according to the color of the light source. This is known as “white balance.” For natural coloration, choose a white balance setting that matches the light source before shooting. Although the default setting, [Auto], can be used under most types of lighting, you can apply the white balance setting suited to a particular light source to achieve more accurate results.

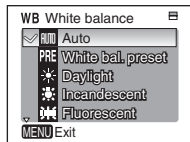

Auto (default setting)

White balance automatically adjusted to suit lighting conditions. Best choice in most situations.



White bal. preset

Neutral-colored object used as reference to set white balance under unusual lighting conditions (📷 77).



Daylight

White balance adjusted for direct sunlight.



Incandescent

Use under incandescent lighting.



Fluorescent

Use under most types of fluorescent lighting.



Cloudy

Use when taking pictures under overcast skies.



Flash

Use with the flash.

The effects of the selected option can be previewed in the monitor. At settings other than [Auto], the icon for the current setting is displayed in the monitor (📷 6).

Flash Mode

At white balance settings other than [Auto] or [Flash], turn the flash off (📷 24).

PRE Preset White Balance

Preset white balance is used with mixed lighting or to compensate for light sources with a strong color cast (for example, to make pictures taken under a lamp with a red shade look as though they had been taken under white light).

1 Place white or gray reference object under the lighting that will be used during shooting.

2 Press the multi selector **▲** or **▼** to choose [White bal. preset] and press **OK**.

- The camera zooms in.
- For information on using the multi selector, see "Multi Selector" (8).

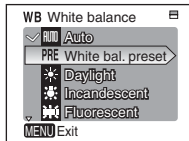

3 Press **▲** or **▼** to choose [Measure].

- To apply the most recently measured value for preset white balance, choose [Cancel] and press **OK**.

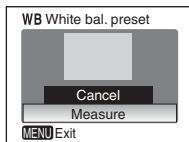

4 Frame the reference object.

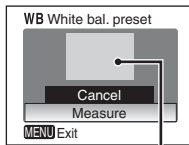

Reference object frame

5 Press **OK**.

- The shutter is released and the new white balance value is set.
- No pictures are recorded.

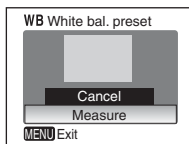

Notes on Preset White Balance

The camera cannot measure a value for preset white balance when the flash fires. Regardless of the flash mode selected, the flash will not fire when **OK** is pressed in step 5.

Continuous

Capture a fleeting expression on a portrait subject, photograph a subject that is moving unpredictably, or capture motion in a series of pictures. At setting other than [Single], focus, and white balance for all photos are determined by the first picture in each series.

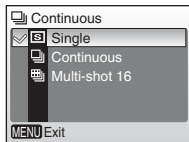



Single (default setting)

One shot is taken each time the shutter-release button is pressed.

Continuous

While the shutter-release button is held down, pictures are taken continuously at a maximum rate of about two frames per second (fps). This rate is maintained for up to five pictures.

Multi-shot 16

Each time the shutter-release button is pressed, camera takes 16 shots at about two frames per second and arrange them in a single picture (L11:  Normal, 2,816 × 2,112 pixels/L10:  Normal, 2,560 × 1,920 pixels) as shown at right. Image mode cannot be changed when [Multi-shot 16] is selected.

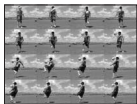

The indicator for the current setting is displayed in the monitor ( 6). When [Single] is selected, no indicator is displayed in the monitor.

BSS Best Shot Selector (BSS)

The “best shot selector” is recommended from situations in which inadvertent camera movement can result in blurred pictures, or when parts of the image are prone to under- or over-exposure.

At [On] setting, the flash automatically turns off and focus, exposure, and white balance for all pictures are determined by the first picture in each series.

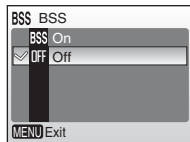

BSS On

Recommended for taking pictures in poorly lit places, or in other situations where camera shake may occur. Camera takes shots while shutter-release button is pressed, to a maximum of ten. These images are then compared and the sharpest picture (picture with highest level of detail) is saved.

OFF Off (default setting)

Only one picture is taken.

The icon for the current setting is displayed in the monitor (📷 6).

🔪 Note on Best Shot Selector

BSS may not produce the desired results if the subject moves or the composition changes while the shutter-release button is pressed all the way down.

🔧 Color Options

Make colors more vivid or record pictures in monochrome.

📷 Standard color (default setting)

Use for pictures exhibiting natural color.

📷 Vivid color

Use to achieve a vivid, “photoprint” colors.

📷 Black-and-white

Record pictures in black-and-white.

📷 Sepia

Record pictures in sepia tones.

📷 Cyanotype

Record pictures in cyan-blue monochrome.

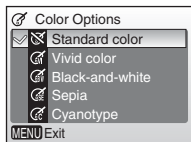

The effects of the selected option can be previewed in the monitor. At settings other than [Standard color], the icon for the current setting is displayed in the monitor (📷 6).

Restrictions on Camera Settings

Restrictions apply to the following settings in  mode:

Flash mode

Flash turns off at [Continuous] settings other than [Single] or when [BSS] is on. Applied setting is restored when [Single] is selected or [BSS] is turned off.

Self-timer

If self-timer is on, only one shot will be taken when shutter is released, regardless of settings chosen for [Continuous] and [BSS]. Applied [Continuous] and [BSS] setting is restored when picture is taken or self-timer is turned off.

Continuous

Selecting [Continuous] or [Multi-shot 16] turns [BSS] off. Applied [BSS] setting is not restored when [Single] is selected.

BSS



















[Continuous] is automatically set to [Single] when [BSS] is on. Applied [Continuous] setting is not restored when [BSS] is turned off.

White balance and color options

White balance is automatically set to [Auto] and cannot be adjusted when [Black-and-white], [Sepia], or [Cyanotype] is selected for [Color Options]. Applied white balance setting is restored when [Standard color] or [Vivid color] is selected.

Playback Options: The Playback Menu

The following options are available in the playback menu.

	Set up	 87
Display the setup menu.		
	Print set	 69
Select pictures for printing.		
	Slide show	 83
View pictures in an automatic slide show.		
	Delete	 84
Delete all or selected pictures.		
	Protect	 84
Protect selected pictures from accidental deletion.		
	Transfer marking	 85
Change transfer marking for existing pictures.		
	Small pic.	 45
Create a small copy of the current picture.		
	Voice memo	 46
Record voice memos for pictures.		
	Copy	 86
Copy files between the memory card and internal memory.		

Displaying the Playback Menu

Display a picture by pressing  and press **MENU** to display the playback menu.

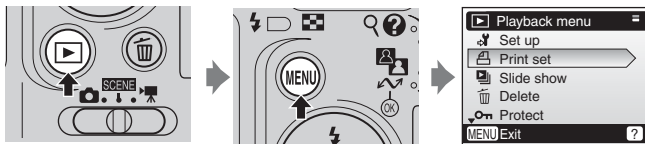

- To choose menus and apply selection, use the multi selector ( 8).
- To exit the playback menu, press **MENU** again.

Selecting Multiple Pictures

When following the step below to select multiple pictures for a print set (📷 69), deletion (📷 84), protection from deletion (📷 84), transfer (📷 85), copying between internal memory and the memory card (📷 86), or for the welcome screen (📷 89), the screen shown at right is displayed. Follow the procedure described below to select multiple pictures.

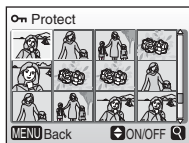

1 Press the multi selector ◀ or ▶ to choose a picture from a list of thumbnails.

- Only one picture can be selected for [Welcome screen]. Proceed to step 3.
- Press **T** (Q) to switch to full-frame playback. Press **W** (📷) to switch back to thumbnail display.
- For information on using the multi selector, see “Multi Selector” (📷 8).

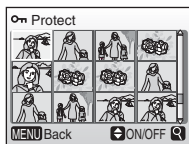

2 Press ▲ or ▼ to choose [ON] or [OFF] (or the number of copies when applying print settings).

- When [ON] is selected, a check mark (✓) is displayed in the top left corner of the current picture. Repeat steps 1 and 2 to select additional pictures.

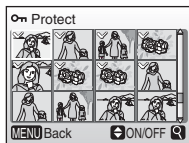

3 Press **OK**.

- The setting is enabled.

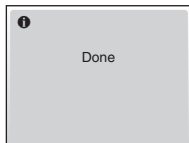

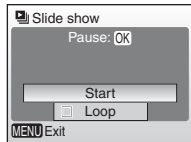

Slide Show

Play pictures back in an automated “slide show” with a three-second interval between pictures.







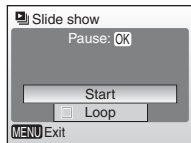

1 Press the multi selector ▲ or ▼ to choose [Start] and press .

- To repeat the slide show automatically, enable [Loop] and press  before choosing [Start].  will be added to the loop option when enabled.
- For information on using the multi selector, see “Multi Selector” ( 8).



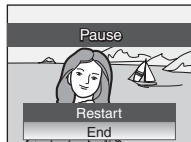

2 Slide show begins.

- While the slide show is in progress, the following operations can be performed:
 - Press  to skip to the next picture, or  to return to the previous picture. Hold  or  down to fast forward or rewind.
 - Press  to pause the slide show.
- The menu shown at right is displayed when the slide show ends or is paused. Choose [Restart] and press  to play the slide show again, or [End] to stop the slide show and return to the playback menu.



Notes on Slide Show

- Only the first frame of movies ( 51) included in slide shows is displayed.
- Select [Loop] to repeat the slide show until  is pressed. Note that the monitor will turn off automatically if no operations are performed for 30 minutes. The camera will turn off automatically if no operations are performed for another three minutes.

Delete

The delete menu contains the options shown below.

If no memory card is inserted in the camera, pictures in the internal memory will be deleted. If a memory card is inserted, pictures on the memory card will be deleted.

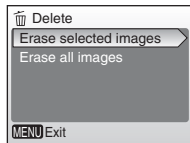



Erase selected images

Delete selected pictures.

See "Selecting Multiple Pictures" ( 82) for more information on using this function.

Erase all images

Delete all pictures stored in the internal memory or on the memory card.



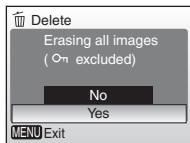



- Choose [Yes] and press  in the confirmation dialog to delete all pictures. To exit without deleting pictures, choose [No] and press .



Notes on Deletion

- Once deleted, pictures cannot be recovered. Transfer important images to a computer before deletion.
- Pictures marked with the  icon are protected and cannot be deleted.



Protect

Protect selected pictures from accidental deletion. Protected pictures are recognized by the  icon ( 7) in full-frame playback and the erase selected images screen, and by the  icon ( 40) in thumbnail playback. Protected pictures cannot be deleted with  or by selecting [Delete] from the playback menu. Note, however, that formatting will delete protected files ( 98).

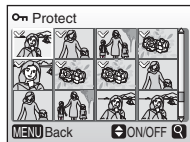
See "Selecting Multiple Pictures" ( 82) for more information on using this function.



Transfer Marking

When the camera is connected to a computer via the supplied USB cable and  (OK) is pressed to transfer pictures, only pictures marked with the  icon are transferred ( 61). At the default setting, all pictures are marked for transfer.

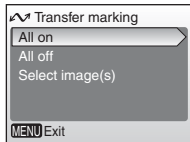

All on

Mark all images for transfer.

All off

Remove transfer marking from all images.

Select image(s)

Mark selected pictures for transfer.

See “Selecting Multiple Pictures” ( 82) for more information on using this function.

Pictures selected for transfer are recognized by the  icon ( 7) in full-frame playback, and by the  icon ( 40) in thumbnail playback.

Marking for Transfer

- No more than 999 pictures can be marked for transfer. If more than 999 pictures are marked, use PictureProject to transfer the pictures. See the *PictureProject Reference Manual* (on CD) for details.
- The camera does not recognize transfer settings applied with another make or model of digital camera. Select pictures for transfer using the same model that initially took the pictures.



Copy

Copy pictures between the internal memory and a memory card.

The options of this menu allows you to copy the specified pictures or all pictures in the internal memory or on the memory card.

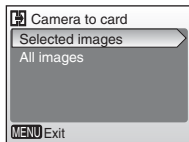
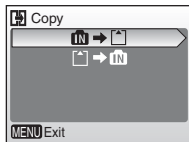
See “Selecting Multiple Pictures” (82) for more information on using the [Selected images] option.



	Copy pictures from internal memory to memory card.
	Copy pictures from memory card to internal memory.

Notes on Copying Pictures

- If there is not enough space in the memory or on the memory card to receive the copy, an error message will be displayed. Delete unwanted pictures or voice recordings, or insert a new memory card (if using a memory card) before trying again.
- The file format of images that can be copied is JPEG, MOV, or WAV.
- The camera may be unable to copy pictures that were created with another make of camera or that have been modified on a computer.

[Memory contains no images.] Message

If there are no pictures stored on the memory card when playback mode is applied, the message, [Memory contains no images.], is displayed. Press **MENU** to display the copy option screen, and copy the pictures stored in the camera's internal memory to the memory card.

File Number































- When pictures are copied using the [Selected images] option, the newly copied pictures are numbered consecutively from the largest number existing between the two memory sources.
- Ex: when the last number in the source memory is 32 (DSCN0032.JPG) and the last number in the destination memory is 15 (DSCN0015.JPG)
The copied pictures are assigned numbers starting from DSCN0033.
After that, numbering will continue from the lowest number after the number of the last file that was copied.
- When pictures are copied using the [All images] option, all the pictures in the folder are copied with the same file numbers. The newly copied folder is assigned the lowest available number.

Copies

Copies have the same protection marking as the original but are not marked for printing (86) or transfer (85).

Basic Camera Setup: The Setup Menu

The following options are available in the setup menu.

	Menus  88
	Choose how menus are displayed.
	Quick startup  89
	Enable or disable welcome screen and start-up sound.
	Welcome screen  89
	Select screen displayed when camera is turned on.
	Date  90
	Set camera clock and choose home and destination time zones.
	Monitor settings  93
	Adjust monitor brightness and choose display style.
	Date imprint  94
	Imprint date or date counter on pictures.
	Sound settings  96
	Adjust sound and volume settings.
	Blur warning  96
	Choose whether or not to perform a camera shake check.
	Auto off  97
	Set time before camera enters standby mode to save power.
	Format memory/Format card  98
	Format internal memory or memory card.
	Language  99
	Choose language for camera menus and messages.
	Interface  99
	Adjust settings for connection to television or computer.
	Reset all  100
	Restore camera settings to default values.
	Battery Type  101
	Choose type of batteries inserted in camera.
	Firmware version  101
	Display camera firmware version.

Displaying the Setup Menu

Choose [Set up] in the shooting menu (📷 73), scene menu (📷 29), movie menu (📷 49), or playback menu (📷 81) and press **OK** to display the setup menu.

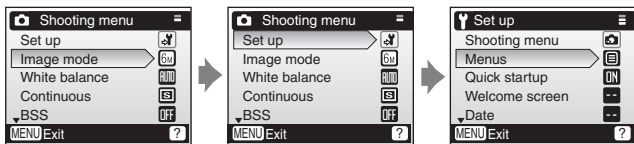

Display the menu screen Press the multi selector **▲** or **▼** to select [Set up] and press **OK**.

- To choose menu and apply selection, use the multi selector (📷 8).
- To exit the setup menu, press **MENU** again.

MENU Menu

Choose whether the menu displayed when **MENU** is pressed use text or icons. When [Icons] is selected, all menu items can be displayed in a single page with the name of the highlighted menu displayed at the top of the page.

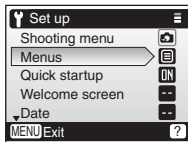
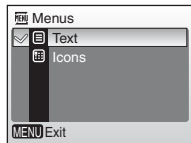

Text

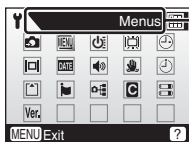

Icon

Menu names

Quick Startup

Choose [On] (default setting) to disable the welcome screen and start-up sound. The camera will be ready for shooting as soon as it is turned on.

Set to [Off] when enabling the welcome screen.

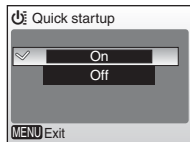

Welcome Screen

You can select the welcome screen to be displayed when the camera is turned on.

To set the welcome screen, [Quick startup] must be set to [Off].

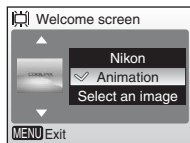

Nikon



Displays a welcome screen when the camera is turned on.

Animation (default setting)

Displays a short animation when the camera is turned on.

Select an image

Select a picture in the internal memory or on the memory card for the welcome screen.

Choose a picture in the picture selection screen ( 82), and press .

The image used in the welcome screen is a copy of the selected picture and, therefore, is not affected if the original picture is deleted or the memory card is removed.

When "Select an image" is Selected

If you have already selected a welcome screen picture, you can select a new one by following the confirmation dialog.

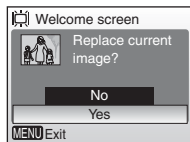

Date

Set the camera clock and choose home and travel destination time zones.

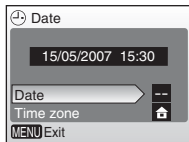



Date

Set camera clock to current date and time ( 12-12).

Time zone





 (home time zone) and daylight saving time can be set in the time zone menu. When  (destination time zone) is selected, the time difference ( 92) is automatically calculated and the date and time in the selected region are recorded. Useful when travelling.

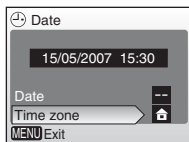

Setting Travel Destination Time Zone

1 Press the multi selector  or  to choose [Time Zone] and press .

- The [Time zone] screen is displayed.
- For information on using the multi selector, see "Multi Selector" ( 8).



2 Press  or  to choose  and press .

- The date and time displayed on the monitor changes according to the region currently selected.
- If daylight saving time is in effect, press  to choose [Daylight saving] and press  then press . The time is automatically advanced one hour.

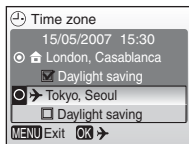

3 Press .

- The [New city time zone] screen is displayed.

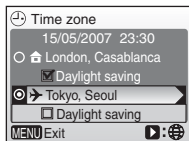

4 Press ◀ or ▶ to choose the travel destination time zone and press **OK**.

- The setting is enabled.
- Press **MENU** to return to shooting mode or playback mode.
- While the travel destination time zone is selected, the ➤ icon will be displayed in the monitor when the camera is in shooting mode.

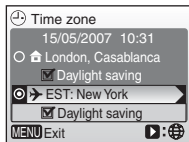
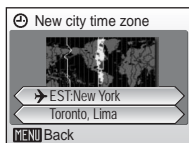

✓ The Clock Battery

The clock battery charges when the main batteries are installed or an AC adapter is connected, and can provide several days of backup power after about ten hours of charging.

✍ **🏠 (Home Time Zone)**

- To switch to the home time zone, choose **🏠** in step 2 and press **OK**.
- To change the home time zone, choose **🏠** in step 2 and perform the following steps for the home time zone.

✍ **🕒 Daylight Saving Time**

- If date and time are set when daylight saving time is not in effect: Turn [Daylight saving] on (✓) when daylight saving time begins to automatically advance the camera's clock one hour.
- If date and time are set with [Daylight saving] turned on (✓) when daylight saving time is in effect: Turn [Daylight saving] off when daylight saving time ends to automatically set the camera's clock back one hour.

 **Time Zones (12)**

The camera supports the time zones listed below. Increments of less than one hour are not supported; when travelling to or from destinations at half- or quarter-hour increments from Greenwich Mean Time (GMT), such as Afghanistan, Central Australia, India, Iran, Nepal, or Newfoundland, set the camera clock to local time.

GMT +/-	Location	GMT +/-	Location
-11	Midway, Samoa	+1	Madrid, Paris, Berlin
-10	Hawaii, Tahiti	+2	Athens, Helsinki
-9	Alaska, Anchorage	+3	Moscow, Nairobi
-8	PST (PDT): Los Angeles, Seattle, Vancouver	+4	Abu Dhabi, Dubai
-7	MST (MDT): Denver, Phoenix, La Paz	+5	Islamabad, Karachi
-6	CST (CDT): Chicago, Houston, Mexico City	+6	Colombo, Dhaka
-5	EST (EDT): New York, Toronto, Lima	+7	Bangkok, Jakarta
-4	Caracas, Manaus	+8	Beijing, Hong Kong, Singapore
-3	Buenos Aires, São Paulo	+9	Tokyo, Seoul
-2	Fernando de Noronha	+10	Sydney, Guam
-1	Azores	+11	New Caledonia
±0	London, Casablanca	+12	Auckland, Fiji

Monitor Settings

The following options are available:

Photo info

Choose information displayed in the monitor.

Brightness

Choose from five settings for monitor brightness.

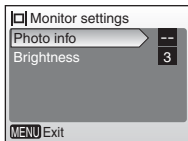

Photo Info

The following display options are available:

	Shooting mode	Playback mode
Show info		
Auto info (default setting)	The current settings or operation guide is displayed for five seconds as in [Show info] above. After five seconds, display will be the same as [Hide info].	
Hide info		
Framing grid	 In (auto) mode, a framing grid is displayed to help frame pictures; other current settings or operation guide is displayed for five seconds as in [Auto info] above. In other shooting modes, the current settings or operation guide is displayed as in [Auto info] above.	 The current settings or operation guide is displayed as in [Auto info] above.

Photo Info

See "The Monitor" for information on indicators in the monitor (6).

Date Imprint

Date and time of recording can be imprinted on pictures for printing this information from printers that are not DPOF-compatible ( 120).

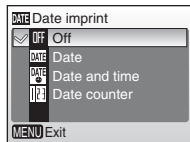

Off (default setting)

Time and date are not imprinted on pictures.

Date

Date is imprinted on the bottom right corner of pictures taken while this option is in effect.

Date and time

Date and time are imprinted on the bottom right corner of pictures taken while this option is in effect.

Date counter

 95



Time stamp shows number of days between date of recording and selected date.

At settings other than [Off], the option selected is recognized by an icon in the monitor during shooting ( 6).

Date Imprint

- Imprinted dates form a permanent part of image data and cannot be deleted.
- Dates imprinted at an image mode setting of [TV screen (640)] may be difficult to read. Choose [PC screen (1024)] or larger when using date imprint.
- The date is recorded using the format selected in the [Date] item ( 12, 90).
- [Date imprint] is not available in movie mode, or when [Panorama assist] scene mode.

[Date imprint] and [Print set]

When using DPOF-compatible devices, shooting date or photo information will be printed if [Date] or [Info] is selected in the print set menu ( 69). See " Differences Between Print Set and Date Imprint" ( 71) for more information on the difference between [Date imprint] and [Print set].

Date Counter

Pictures taken while this option is in effect are imprinted with the number of days remaining until, or the number of days elapsed since a specified date. Use it to track the growth of a child or count down the days until a birthday or wedding.

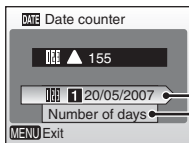

Press **OK** or the multi selector **▶** to display the stored dates option.

Press **OK** to display the display options.

Stored dates

Up to three dates can be stored. To set, highlight an option, press the multi selector **▶**, and enter a date (**12**). To select a date, choose an option and press **OK**.

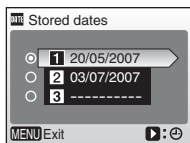

Display options

Choose [Number of days], [Years and days], or [Yrs, mnths, days] and press **OK**.

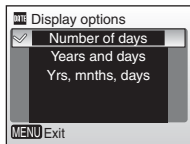

Sample date counter time stamps are shown below.



Two days remaining

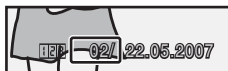

Two days elapsed

🔊 Sound Settings

Adjust the following sound settings:

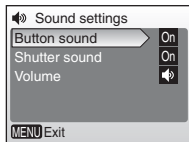

Button sound

When [On] (default setting) is selected, beep will sound once when operations are completed successfully, three times when error is detected.

Shutter sound

Choose [On] to enable shutter sound, or [Off] to disable shutter sound.

Volume

Choose volume of shutter sound, or start-up sound that plays when camera is turned on from [Loud], [Normal] (default setting), and [Off].

👤 Blur Warning

Choose whether or not the blur warning is displayed (📷 25). Note that the warning may not always be displayed (📷 114).

At default setting, blur warning is [On].

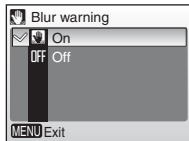

Auto Off

Choose the time allowed to elapse before the camera enters standby mode to save power. The camera will turn off automatically if no operations are performed for three minutes after entering standby mode.

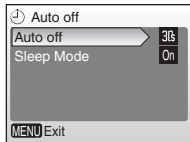

Auto off

Choose the time allowed to elapse before the camera enters standby mode when no operations are performed from [30s] (default setting), [1m], [5m], and [30m].

Sleep Mode

If [On] is selected, the camera will enter standby mode when there is no change in the brightness of the subject in shooting mode, even before the time selected in the auto off menu has elapsed. The camera will enter sleep mode after 30 seconds when [Auto off] is set to [1m] or less, or after a minute when [Auto off] is set to [5m] or more.

Note on Auto Off

The monitor will remain on for three minutes when menus are displayed.

Format Memory/ **Format Card**

Use this option to format the internal memory or memory card.

Formatting the Internal Memory

To format the internal memory, remove the memory card from the camera.

The [Format memory] option appears in the setup menu.

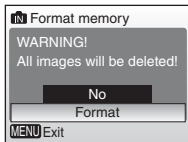

Formatting the Memory Card

When the memory card is inserted in the camera, the [Format card] option appears in the setup menu.

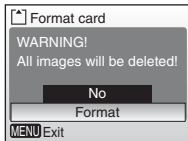

Formatting Internal Memory and Memory Cards

- Formatting the internal memory or memory cards permanently deletes all data. Be sure to transfer important pictures to a computer before formatting.
- Do not turn the camera off or remove the batteries or memory card during formatting.
- The first time you insert the memory cards used in other devices into the COOLPIX L11 or COOLPIX L10, format them.

Language

Choose one of twenty languages for display of camera menus and messages.

Čeština	Italiano	Svenska
Dansk	Nederlands	中文简体
Deutsch	Norsk	中文繁體
English	Polski	日本語
Español	Português	한국어
Français	Русский	ภาษาไทย
Indonesia	Suomi	

Čeština	Czech	Polski	Polish
Dansk	Danish	Português	Portuguese
Deutsch	German	Русский	Russian
English	English (default setting)	Suomi	Finnish
Español	Spanish	Svenska	Swedish
Français	French	中文简体	Simplified Chinese
Indonesia	Indonesian	中文繁體	Traditional Chinese
Italiano	Italian	日本語	Japanese
Nederlands	Dutch	한국어	Korean
Norsk	Norwegian	ภาษาไทย	Thai

Interface

Adjust settings for connection to a computer or video device.

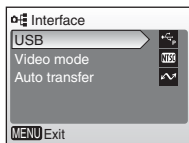

USB

Select [Mass storage] or [PTP] for connection to computer (📷 60) or printer (📷 64).

Video mode

Choose from [NTSC] and [PAL] (📷 58).

Auto transfer

Choose [On] (default setting) to mark all new pictures for transfer to computer (📷 62).

Reset All

This option restores the following settings to their default values:

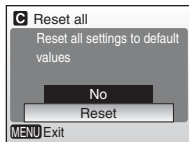

Pop-up menu

Option	Default value
Flash mode (F 24)	⚡ AUTO
Self-timer (S 26)	Off
Macro close-up (M 27)	Off
Exp. +/- (E 28)	0

Movie menu

Option	Default value
Movie options (M 49)	Small size 320

Shooting menu

Option	Default value
Image mode (I 74)	📷 Normal(L11)/📷 Normal(L10)
White balance (WB 76)	Auto
Continuous (C 78)	Single
BSS (B 79)	Off
Color Options (CO 79)	Standard color

Setup menu

Option	Default value
Menus (M 88)	Text
Quick startup (QS 89)	On
Welcome screen (WS 89)	Animation
Photo info (PI 93)	Auto info
Brightness (BR 93)	3
Date imprint (DI 94)	Off
Button sound (BS 96)	On
Shutter sound (SS 96)	On
Volume (V 96)	Normal

Option	Default value
Blur warning (📷 96)	On
Auto off (📷 97)	30 s (thirty seconds)
Sleep Mode (📷 97)	On
Auto transfer (📷 99)	On

Others

Option	Default value
Paper size (📷 65, 67)	Default

- Choosing [Reset] also clears the current file number (📷 103) from memory. Numbering will continue from the lowest number available. To reset file numbering to "0001," delete all pictures (📷 84) before selecting [Reset].
- All other settings, including [Date] (📷 90), [Date counter] (📷 95), [Language] (📷 99), [USB] and [Video mode] in the [Interface] menu (📷 99), and [Battery Type] (📷 101) remain unaffected.

🔋 Battery Type

To ensure that the camera shows the correct battery level (📷 16), choose the type that matches the batteries currently in use.

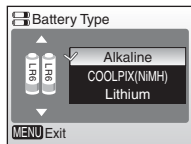

Alkaline (default setting)	LR6 alkaline (AA-size) batteries (supplied)
COOLPIX (NiMH)	EN-MH1 Rechargeable Ni-MH Batteries (available separately from Nikon) ZR6 oxyride (AA-size) batteries (available separately)
Lithium	FR6 lithium (AA-size) batteries (available separately)

📷 Firmware Version

View the current camera firmware version.

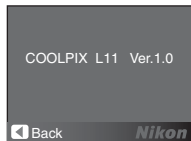

Optional Accessories

At the time of writing, the following optional accessories were available for the COOLPIX L11/COOLPIX L10. Contact your local retailer or Nikon representative for details.

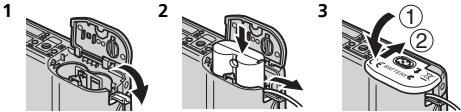
Rechargeable battery	Two EN-MH1 Rechargeable Ni-MH Batteries (EN-MH1-B2)
Battery charger	Battery Charger MH-71
AC adapter	AC Adapter EH-65A (connects as shown)  AC Adapter EH-62B cannot be used.
Audio/Video cable (supplied with L11 only)	Audio/Video Cable EG-CP14

Approved Memory Cards

The following memory cards have been tested and approved for use in the COOLPIX L11/COOLPIX L10:

SanDisk	64 MB, 128 MB, 256 MB, 512 MB, 1 GB, 2 GB ¹ , 4 GB ^{1,2} High-speed, 10-MB/s cards: 512 MB, 1 GB, 2 GB ¹ High-speed, 20-MB/s cards: 1 GB, 2 GB ¹
Toshiba	64 MB, 128 MB, 256 MB, 512 MB, 1 GB, 2 GB ¹ , 4 GB ^{1,2} High-speed, 10-MB/s cards: 128 MB, 256 MB, 512 MB, 1 GB
Panasonic	64 MB, 128 MB, 256 MB, 512 MB, 1 GB, 2 GB ¹ , 4 GB ^{1,2} High-speed, 10-MB/s cards: 256 MB High-speed, 20-MB/s cards: 512 MB, 1 GB, 2 GB ¹

¹ If the memory card will be used with a card reader or similar device, the device must support memory card specifications. If the device does not support memory card specifications, insert the memory card into the camera and connect the camera to a computer via the supplied USB cable to transfer pictures.





²  SDHC-compliant.

Other memory cards have not been tested. For more details on the memory cards listed above, please contact the manufacturer.

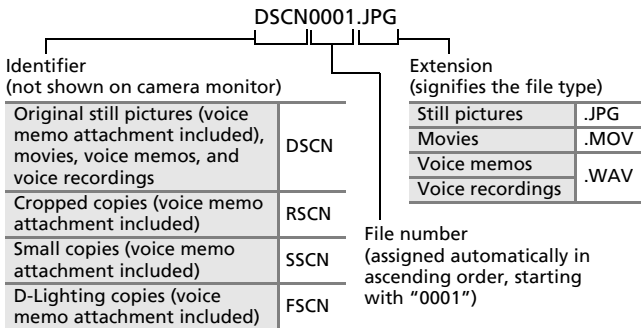
Image/Sound File and Folder Names

Pictures, movies, voice memos, and voice recordings are assigned file names as follows:



- Files are stored in folders named with a folder number followed by a five character identifier: "P_" plus a three-digit sequence number for pictures taken using panorama assist (e.g., "101P_001";  38), "SOUND" for voice recordings (e.g., "101SOUND";  52), and "NIKON" for all other pictures (e.g., "100NIKON"). When the number of files within a folder reaches 9999, a new folder will be created. File numbers will be assigned automatically starting with "0001".
- Files copied using [Copy] > [Selected images] or [Copy sound files] > [Selected files] are copied to the current folder, where they are assigned new file numbers in ascending order starting from the largest file number in memory. [Copy] > [All images] and [Copy sound files] > [Copy all files] copy all folders from the source medium; file names do not change but new folder numbers are assigned in ascending order starting from the largest folder number on the destination medium ( 56, 86).
- Folders can hold up to 200 pictures; if a picture is taken when the current folder contains 200 pictures, a new folder will be created by adding one to the current folder number. If a picture is taken when the current folder is numbered 999 and contains 200 pictures or a picture numbered 9999, no further pictures can be taken until the medium is formatted ( 98) or a new memory card inserted.

Caring for the Camera

To ensure continued enjoyment of this Nikon product, observe the following precautions when using or storing the device.

✔ Handle the lens and all moving parts with care

Do not apply force to the lens, lens cover, monitor, memory card slot, or battery chamber. These parts are easily damaged. Applying force to the lens cover could result in camera malfunction or damage to the lens. Should the monitor break, care should be taken to avoid injury caused by broken glass and to prevent the liquid crystal from the display touching the skin or entering the eyes or mouth.

✔ Do not point the lens at strong light sources for extended periods

Avoid pointing the lens at the sun or other strong light sources for extended periods when using or storing the camera. Intense light may cause deterioration of the CCD image sensor, producing a white blur effect in photographs.

✔ Turn the product off before removing or disconnecting the power source

Do not unplug the product or remove the batteries while the product is on, or while images are being recorded or deleted. Forcibly cutting power in these circumstances could result in loss of data or in damage to product memory or internal circuitry. To prevent an accidental interruption of power, avoid carrying the product from one place to another while an AC adapter is connected.

✔ Keep dry

The device will be damaged if immersed in water or subjected to high humidity.

✔ Do not drop

The product may malfunction if subjected to strong shock or vibration.

✔ Keep away from strong magnetic fields

Do not use or store this device in the vicinity of equipment that generates strong electromagnetic radiation or magnetic fields. Strong static charges or the magnetic fields produced by equipment such as radio transmitters could interfere with the monitor, damage data stored on the memory card, or affect the product's internal circuitry.

✔ Avoid sudden changes in temperature

Sudden changes in temperature, such as occur when entering or leaving a heated building on a cold day, can cause condensation to form inside the device. To prevent condensation, place the device in a carrying case or a plastic bag before exposing it to sudden changes in temperature.

Batteries

- Check the battery level when taking the camera out and replace the batteries if necessary (🔋 16). If possible, carry spare batteries when taking pictures on important occasions.
- Battery capacity tends to decrease on cold days. Be sure that the batteries are fresh before heading outside to take pictures in cold weather. Keep spare batteries in a warm place and exchange as necessary. Once warmed, a cold battery may recover some of its charge.
- Dirt on the battery terminals can prevent the camera from functioning.
- Used batteries are a valuable resource. Please recycle used batteries in accordance with local regulations.

Cleaning

Lens	Avoid touching glass parts with your fingers. Remove dust or lint with a blower (typically a small device with a rubber bulb attached to one end that is pumped to produce a stream of air out the other end). To remove fingerprints or other stains that cannot be removed with a blower, wipe the lens with a soft cloth, using a spiral motion that starts at the center of the lens and working toward to the edges. If this fails, clean the lens using a cloth lightly dampened with commercial lens cleaner.
Monitor	Remove dust or lint with a blower. To remove fingerprints and other stains, clean the monitor with a soft, dry cloth, being careful not to apply pressure.
Body	Use a blower to remove dust, dirt, or sand then wipe gently with a soft, dry cloth. After using the camera at the beach or seaside, wipe off any sand or salt with a dry cloth lightly dampened with fresh water, then dry thoroughly. Note that foreign matter inside the camera could cause damage not covered by the warranty.

Do not use alcohol, thinner, or other volatile chemicals.

Storage

Turn the camera off when not in use. Check that the power-on lamp is off before putting the camera away. Remove the batteries if the camera will not be used for an extended period. Do not store the camera with naphtha or camphor moth balls or in locations that:

- are next to equipment that produces strong electromagnetic fields, such as televisions or radios
- are exposed to temperatures below -10°C (14°F) or above 50°C (122°F)
- are poorly ventilated or subject to humidities of over 60%











To prevent mold or mildew, take the camera out of storage at least once a month. Turn the camera on and release the shutter a few times before putting the camera away again.







Notes on the Monitor



- The monitor may contain a few pixels that are always lit or that do not light. This is a characteristic common to all TFT LCD displays, and does not indicate a malfunction. Images recorded using the product will not be affected.
- When framing bright subjects, vertical comet-like streaks that whiten toward either end may appear in the display. This phenomenon, known as “smear,” does not appear in the final photograph and does not indicate a malfunction. Some smear may appear in movies.
- Images in the monitor may be difficult to see under bright lighting.
- The monitor is lit by an LED backlight. Should the monitor begin to dim or flicker, contact your Nikon service representative.





Error Messages















The following table lists the error messages and other warnings displayed in the monitor, as well as the solutions for dealing with them.

Display	Problem	Solution	
 (blinks)	Clock not set.	Set clock.	90
	Batteries running low.	Ready spare batteries.	10, 101
 Warning! Battery exhausted.	Batteries exhausted.	Replace batteries.	
AF ● (● blinks red)	Camera cannot focus.	Recompose picture.	20, 21
 (blinks)	Slow shutter speed. Pictures may be blurred.	Use flash, or steady camera using tripod, by placing camera on level surface, or by holding camera in both hands with elbows against torso.	4, 18, 24
 Warning!! Please wait for the camera to finish recording. 	Camera cannot perform other operations until recording is complete.	Message clears from display automatically when recording is complete.	21
 Memory card is write protected.	Write-protect switch is in "lock" position.	Slide write-protect to "write" position.	15
 This card cannot be used.	Error accessing memory card.	<ul style="list-style-type: none"> • Use approved card. • Check that connectors are clean. • Confirm that memory card is correctly inserted. 	102
 Warning! This card cannot be read.			14



Display	Problem	Solution	
<p> Card is not formatted.</p> <p>Format No</p>	Memory card has not been formatted for use in camera.	Highlight [Format] and press  to format card, or turn camera off and replace card.	15
<p> Out of memory.</p>	Memory card is full.	<ul style="list-style-type: none"> • Choose smaller image size. • Delete pictures or voice recordings. • Insert new memory card or remove memory card and use internal memory. 	30, 74 22,47, 55, 84 14, 15
<p> Image cannot be saved.</p>	Error occurred while recording picture.	Format internal memory or memory card.	98
	Camera has run out of file numbers.	<ul style="list-style-type: none"> • Insert new memory card. • Format internal memory or memory card. 	14 98
	Cannot create cropped, D-Lighting, or small copy.	Select picture that supports crop, D-Lighting, or small picture.	42
	Picture cannot be used for welcome screen.	Choose picture 640 × 480 pixels or larger.	—
	Cannot copy picture.	Delete pictures from destination.	84
<p> Sound file cannot be saved.</p>	Camera has run out of file numbers.	<ul style="list-style-type: none"> • Insert new memory card. • Format internal memory or memory card. 	14 98

Display	Problem	Solution	
i Memory contains no images.	No pictures or sound file in the internal memory or memory card.	Press  to switch to the shooting mode or the voice recording mode.	16, 52
i No sound file.	Memory card does not contain pictures or sound file.	To copy picture or sound file from internal memory to memory card, press MENU . The copy option screen or copy sound file screen will be displayed.	56
i Image has already been modified. D-Lighting cannot be used.	Image can not be enhanced using D-Lighting.	Copies from D-Lighting, crop, or small picture option can not be adjusted using D-Lighting.	42
i Cannot record movie.	Time out error while recording movie.	Choose memory card with faster write speed.	102
i File contains no image data.	File not created with COOLPIX L11/COOLPIX L10.	View file on computer or other device.	—
w This file cannot be played back.			
i This image cannot be deleted.	Picture is protected.	Remove protection.	84
i New city is in the current time zone.	Destination in same time zone as home.	No need to change time zones if destination is in same time zone as home.	90
Lens error w	Lens error.	Turn camera off and then on again. If error persists, contact retailer or Nikon representative.	10

Display	Problem	Solution	
 Communications error	USB cable disconnected during transfer or printing.	If PictureProject displays error in the monitor of the computer, click [OK] to exit. Resume operation after turning camera off and reconnecting cable. When the camera is connected to a printer, refer to the instructions of the printer.	61, 64
	[USB] option incorrect.	Choose correct [USB] option.	59, 60
	PictureProject did not start.	—	—
 No images are marked for transfer.	No pictures selected for transfer.	Select pictures for transfer in the playback menu and try again.	85
 Transfer error	Transfer error.	<ul style="list-style-type: none"> • Check battery level. • Check that USB cable is connected. 	16
			59
System error 	Error has occurred in camera's internal circuitry.	Turn camera off, remove and reinsert batteries, and turn camera on. If error persists, contact retailer or Nikon representative.	10

Display	Problem	Solution	
 Printer error Check printer status.	Running out of ink or printer error.	Check printer. After checking the ink or solving the problem, select [Resume] and press  to resume printing.*	—
 Printer error: check paper	Specified size of paper is not loaded in printer.	Load the specified paper, select [Resume], and press  to resume printing.*	—
 Printer error: paper jam	Paper has jammed in the printer.	Eject the jammed paper, select [Resume], and press  to resume printing.*	—
 Printer error: out of paper	No paper is loaded in printer.	Load the specified paper, select [Resume], and press  to resume printing.*	—
 Printer error: check ink	Ink error.	Check ink, select [Resume], and press  to resume printing.*	—
 Printer error: out of ink	Ink cartridge is empty.	Replace ink, select [Resume], and press  to resume printing.*	—
 Printer error: file corrupt	An error caused by the image file has occurred.	Select [Cancel] and press  to cancel printing.	—













* See the documentation provided with your printer for further guidance and information.









Display	Problem	Solution	
 Interface error	The camera is connected to a computer or TV while attached to the dock insert.	<ul style="list-style-type: none">• Disconnect the AV cable or the USB cable to print pictures.• To connect to a computer, remove the camera from the dock insert and disconnect the AV cable.• To connect to a TV, remove the camera from the dock insert and disconnect the USB cable.	72 58 62

Troubleshooting

If the camera fails to function as expected, check the list of common problems below before consulting your retailer or Nikon representative. Refer to the page numbers in the right-most column for more information.

Problem	Cause/Solution	
Camera turns off without warning	<ul style="list-style-type: none"> Batteries are low. Batteries are cold. 	16 105
Monitor is blank	<ul style="list-style-type: none"> Camera is off. Batteries are exhausted. Standby mode for saving power. Press the shutter-release button halfway. Flash lamp blinks: wait until flash has charged. USB cable is connected. A/V cable is connected. 	10 16 21 25 59 58
No indicators displayed in monitor	[Hide info] is selected for [Photo info]. Select [Show info].	93
Monitor is hard to read	<ul style="list-style-type: none"> Ambient lighting is too dark: move to a brighter location. Adjust monitor brightness. Monitor is dirty. Clean monitor. 	93 105
Date and time of recording are not correct	Voice recordings recorded before clock has been set, and "Date not set" indicator blinks during recording, will have time stamp of "01/01/2007 00:00". Set the correct date and time from [Date] in the setup menu.	12, 90
Camera settings reset	Clock battery exhausted. Charge clock battery.	91
No picture taken when shutter-release button is pressed	<ul style="list-style-type: none"> Menus are displayed: press MENU. Batteries are exhausted. Flash lamp blinks: flash is charging. 	9, 73, 81, 87 16 25

Problem	Cause/Solution	
Camera cannot focus	<ul style="list-style-type: none"> The intended subject is one with which autofocus does not perform well. Focus error. Turn camera off and then on again. 	21 10
Pictures are blurred	<ul style="list-style-type: none"> Use flash. Use . Use tripod and self-timer. 	24 79 4, 26
Blur warning is not displayed	Blur warning is not displayed in self-timer mode,  mode or when [ Sports], [ Museum], [ Fireworks show], or [ Panorama assist] is selected in scene mode, option other than [Single] is selected for [Continuous], or [BSS] is on.	26, 29, 48, 78, 79
Pictures are too dark (underexposed)	<ul style="list-style-type: none"> Flash is off. Flash window is blocked. Subject is beyond flash range. Adjust exposure compensation. Subject is backlit. Select  ([Back light] scene mode) or use fill flash. 	24 18 24 28 24, 36
Pictures are too bright (overexposed)	Adjust exposure compensation.	28
Randomly-spaced bright pixels ("noise") appear in image	Shutter speed too slow. Noise can be reduced by: <ul style="list-style-type: none"> Using flash [ Night portrait], [ Dusk/dawn], or [ Night landscape] is selected in scene mode. 	24, 32, 34
Pictures appear smeared	Lens is dirty. Clean lens.	105
Colors are unnatural	White balance does not match light source.	76
Flash does not fire	Flash is off. Note that flash turns off automatically in  mode and some scene modes, or when option other than [Single] is selected for [Continuous], or [BSS] is on.	24 29 48 78, 79, 80

Problem	Cause/Solution	
Portions of pictures not related to the “red eye” phenomenon are affected	In-camera red-eye fix may, in very rare circumstances, be applied to areas of pictures not affected by “red eye” when pictures are taken in  (auto with red-eye reduction) flash mode, or [ portrait] or [ Night portrait] scene modes. Use a different shooting mode or set flash mode to  (auto) or  (fill flash).	24, 31, 32
Bright specks appear in pictures taken with flash	Flash is reflecting off particles in air. Turn flash off.	24
No sound when shutter is released	[Off] selected for [Sound settings]>[Shutter sound] or [Volume] in the setup menu.	96
Optical zoom cannot be used	Optical zoom cannot be used while recording movies.	48
Digital zoom cannot be used	Digital zoom is not available when  (Portrait) or  (Night portrait) is selected for scene mode, or when option other than [Single] is selected for [Continuous].	29, 78
[Image mode] not available	[Image mode] cannot be adjusted when [Multi-shot 16] is selected for [Continuous].	78
[Date imprint] not available	Camera clock has not been set.	12, 90
Date not appearing on pictures	Date does not appear on movies or on pictures taken using panorama assist.	38, 51
File cannot be played back	File has been overwritten or renamed by computer or other make of camera.	—
Cannot zoom in on picture	Playback zoom cannot be used with movies, small pictures, or pictures that have been cropped to below 320 × 240.	—
Cannot record voice memo	Voice memos cannot be appended to movies.	—
Cannot mark pictures for transfer	No more than 999 pictures can be marked for transfer. Click Picture-Project [Transfer] to transfer pictures.	62

Problem	Cause/Solution	
Transfer marking does not appear	Pictures were marked for transfer using another model of camera. Select pictures for transfer using the same model that initially took the pictures.	—
PictureProject does not start when camera is connected	<ul style="list-style-type: none"> • Camera is off. • Batteries are exhausted. • USB cable is not correctly connected. • Appropriate [USB] option is not selected. • Camera is not registered in Device Manager (Windows only). See the <i>PictureProject reference manual</i> (on CD) for further information. • Computer is not set to launch PictureProject automatically. 	10 16 61 59, 60 — —
Pictures not displayed on television	Choose correct video mode. Memory card contains no pictures. Replace memory card. Remove memory card to play back pictures from internal memory.	58 14
Pictures to be printed or transferred are not displayed	Memory card contains no pictures. Replace memory card. Remove memory card to print or transfer pictures from internal memory.	—
Cannot select paper size from camera	Paper size cannot be selected from the camera if the printer does not support the page sizes used by the camera or the printer automatically selects the page size. Use the printer to select page size.	—

Electronically Controlled Cameras

In extremely rare instances, unusual characters may appear in the monitor and the camera may stop functioning. In most cases, this phenomenon is caused by a strong external static charge. Turn the camera off, remove and replace the batteries, and then turn the camera on again. In the event of continued malfunction, contact your retailer or Nikon representative. Note that disconnecting the power source as described above may result in the loss of any data not recorded to internal memory or the memory card at the time the problem occurred. Data already recorded will not be affected.



Specifications

Nikon COOLPIX L11/COOLPIX L10 Digital Camera

Type	Compact digital camera
Effective pixels	L11: 6.0 million L10: 5.0 million
Image sensor	1/2.5-in. CCD
Total pixels	L11: 6.18 million L10: 5.05 million
Lens	3× Zoom-Nikkor lens
Focal length	6.2–18.6mm (equivalent with 35mm [135] format picture angle: 37.5–112.5mm)
f/-number	f/2.8–5.2
Construction	6 elements in 5 groups
Digital zoom	Up to 4× (equivalent with 35mm [135] format picture angle: approx. 450mm)
Autofocus (AF)	Contrast-detect AF
Focus range (from lens)	40 cm (15.7 in.) to ∞ Macro close-up mode: 15 cm (5.9 in.) to ∞ [W]
Focus-area	Center
Monitor	L11: 2.4 in., 115,000-dot, TFT LCD with brightness adjustment L10: 2.0 in., 153,000-dot, TFT LCD with brightness adjustment
Frame coverage	Shooting mode: Approx. 97% horizontal and 97% vertical Playback: Approx. 100% horizontal and 100% vertical
Storage	
Media	<ul style="list-style-type: none"> • Internal memory (approx. 7 MB) • Secure Digital (SD) memory cards
File system	DCF, Exif 2.2, and DPOF compliant
File formats	Compressed: JPEG-Baseline-compliant Movies: QuickTime, Audio files: WAV

Image size (pixels)	<p>L11:</p> <ul style="list-style-type: none"> • 2,816 × 2,112 [High (2816★)/Normal (2816)] • 2,048 × 1,536 [Normal (2048)] • 1,024 × 768 [PC screen (1024)] • 640 × 480 [TV screen (640)] <p>L10:</p> <ul style="list-style-type: none"> • 2,560 × 1,920 [High (2560*)/Normal (2560)] • 2,048 × 1,536 [Normal (2048)] • 1,024 × 768 [PC screen (1024)] • 640 × 480 [TV screen (640)]
ISO sensitivity (Standard output sensitivity)	ISO 64 (auto gain to ISO 800)
Exposure	
Metering	256-segment Matrix, center-weighted (digital zoom up to 2×), spot (digital zoom greater than 2×), spot AF area
Exposure control	Programmed auto exposure with exposure compensation (-2.0 to +2.0 EV in steps of 1/3 EV)
Range	[W]: 1.0 to 16.0 EV, [T]: 1.0 to 17.0 EV
Shutter	Mechanical and charge-coupled electronic shutter
Speed	4 to 1/2000 s
Aperture	Electronically controlled preset aperture
Range	2 steps (f/2.8 and f/5.2 [W])
Self-timer	10 seconds duration
Built-in flash	
Range	[W]: 0.4 to 3.0 m (1 ft. 4 in. to 9 ft. 10 in.) [T]: 0.4 to 2.5 m (1 ft. 4 in. to 8 ft. 2 in.)
Flash control	Sensor flash system
Interface	USB
Video output	Can be selected from NTSC and PAL
I/O terminals	<ul style="list-style-type: none"> • Audio/video (A/V) out • Digital I/O (USB) • ImageLink I/O (COOLPIX L11 only)

Supported languages	Czech, Danish, German, English, Spanish, French, Indonesian, Italian, Dutch, Norwegian, Polish, Portuguese, Russian, Finnish, Swedish, Chinese (Simplified and Traditional), Japanese, Korean, Thai
Power sources	<ul style="list-style-type: none"> • LR6 alkaline (AA-size) battery × 2 (supplied) • ZR6 oxyride (AA-size) battery × 2 (available separately) • FR6 lithium (AA-size) battery × 2 (available separately) • Rechargeable Ni-MH Battery EN-MH1 × 2 (available separately from Nikon) • AC Adapter EH-65A (available separately from Nikon)
Battery life*	<ul style="list-style-type: none"> • Approx. 250 shots with LR6 alkaline (supplied) • Approx. 250 shots with ZR6 oxyride (available separately) • Approx. 600 shots with FR6 lithium (available separately) • Approx. 300 shots with Rechargeable Ni-MH Battery EN-MH1 (available separately from Nikon)
Dimensions (W × H × D)	<p>L11: Approx. 89.5 × 60.5 × 27 mm (3.5 × 2.4 × 1.1 in.) (excluding projections)</p> <p>L10: Approx. 89.5 × 60.5 × 26 mm (3.5 × 2.4 × 1.0 in.) (excluding projections)</p>
Weight	<p>L11 (without battery and memory card): Approx. 125 g (4.4 oz.)</p> <p>L10 (without battery and memory card): Approx. 115 g (4.1 oz.)</p>
Operating environment	
Temperature	0 to 40 °C (32 to 104 °F)
Humidity	Less than 85% (no condensation)

* Based on Camera and Imaging Products Association (CIPA) standards for measuring the life of camera batteries. Measured at 23 °C (73 °F); zoom adjusted with each shot, flash fired with every other shot, image mode set to [ Normal (2816)] for L11/[ Normal (2560)] for L10. Battery life may vary depending on shooting interval and length of time menus and images being displayed.

The supplied batteries are for confirming that the camera is working properly immediately after purchase. They have a lower capacity than batteries purchased separately.

- Unless otherwise stated, all figures are for a camera with alkaline batteries operated at an ambient temperature of 25 °C (75 °F).

Dock Insert PV-14 (supplied with COOLPIX L11)

Dimensions (W × H × D)	Approx. 135.5 × 22.5 × 63 mm (5.3 × 0.9 × 2.5 in.) (excluding projections)
Weight	Approx. 32 g (1.1 oz)

Specifications

Nikon will not be held liable for any errors this manual may contain. The appearance of this product and its specifications are subject to change without notice.



















Supported Standards

- **DCF:** Design Rule for Camera File System is a standard widely used in the digital camera industry to ensure compatibility among different makes of camera.
- **DPOF:** Digital Print Order Format is an industry-wide standard that allows pictures to be printed from print orders stored on the memory card.
- **Exif version 2.2:** This camera supports Exif (Exchangeable Image File Format for Digital Still Cameras) version 2.2, a standard that allows information stored with photographs to be used for optimal color reproduction when images are output from Exif-compliant printers.
- **PictBridge:** A standard developed cooperatively by the digital camera and printer industries, allowing photographs to be output directly to a printer without connecting the camera to a computer.
- **ImageLink:** The ImageLink standard allows pictures taken with a digital camera to be printed directly on a household printer, without using a computer.

The COOLPIX L11 can be connected directly to any ImageLink-compatible printer for one-touch picture printing.

Index

Symbols

- W** () button 18, 27
-  (**W**) button 40, 41, 44
- T** () button 18, 27
-  (**T**) button 40, 41, 44
- T** () button 9
- MENU** button 5, 9, 88
-  button 5, 8
-  (flash) button 5, 24
-  (self-timer) button 5, 26
-  (macro close-up) button 5, 27
-  (exposure) button 5, 28
-  (playback) button 5, 22, 58
-  (delete) button 5, 22, 51
-  (auto) mode 8
- SCENE** (scene) mode 8, 29
-  (movie) mode 8, 48, 50
-  face-priority AF 37
-  () D-lighting 43
-  Voice recording 52

A

- AC adapter 11, 57, 102
- Audio/Video (A/V) cable 102
- Audio/video (A/V) cable (EG-CP14) 58
- Auto off 97
- Auto transfer 99

B

- Back light 36
- Batteries 4, 10, 101
 - chamber cover 4
 - charger 102
 - EN-MH1 10, 101, 102
 - FR6 lithium 10, 101
 - LR6 alkaline 10, 11, 101
 - ZR6 oxyride 10, 101
- Battery level 16
- Battery type 11, 101
- Beach/snow 33
- Best shot selector 79
- Blur 25
- Blur warning 25, 96
- Brightness 93
- BSS 79

C

- Cable connector 5, 58, 61, 64
- Cleaning 105
 - body 105
 - lens 105
 - monitor 105
- Close up 34
- Color options 79
- Computer, connecting to 59
- Continuous 78
- Copy 35
 - copying pictures to 86
- Crop 44

D

- Date 12, 90
- Date counter 95
- Date imprint 94
- Daylight saving time 12, 91

DCF 120
Delete 84
Digital print order format 69, 120
D-Lighting 43
Dock insert 72, 120
DPOF 69, 120
DPOF printing 68
DSCN 103
Dusk/dawn 34

E

Editing pictures 42
 creating a cropped copy 44
 enhancing contrast 43
 resizing pictures 45
EH-65A 57, 102
Exif version 2.2 120

F

Face-priority AF 31, 37
File names 103
Fireworks show 35
Firmware version 101
Flash 4, 24
 lamp 25
 mode 24
Flash lamp 5
Focus 20, 21
Focus area 20
Folder names 103
Formatting
 internal memory 98
 memory cards 15, 98
Framing pictures 18
FSCN 103

H

Help 9

I

Image mode 17, 30, 74
Image quality 74
Image size 74
ImageLink 120
 compatible printer 72
 connector 5
Interface 99
Internal memory 14
 formatting 98
ISO 25

J

JPG 103

L

Lamp, red  25
Landscape 31
Language 99
Lens 4

M

Macro close-up mode 27
Memory cards 5, 14, 102
 capacity of 16
 formatting 15, 98
 slot cover 5
Menus, text or icons 88
Microphone 4, 46
Mode selector 5, 8
Monitor 5, 6
Monitor settings 93
MOV 103
Movie menu 49
Movie mode 48

- Movie options 49
 - maximum movie length 49
 - small size 49
 - smaller size 49
 - TV movie 49

- Movies
 - playback 51
 - recording 48

Multi selector 5, 8

Museum 35

N

Night

- landscape 34

- portrait 32

NTSC 99

Number of exposures remaining
16, 75

O

On/Off, see Power switch

P

PAL 99

Panorama assist 36, 38

- AE-L 39

Paper size 65, 67

Party/indoor 33

PictBridge 63, 120

Playback

- full-frame playback 22

- thumbnail playback 40

- viewing pictures 23

Playback menu 81

Portrait 31

Power switch 4, 10

Power-on lamp 4, 10

Print set 69

- printing date 70, 71

- shooting information 70

Printing pictures 63, 65, 66

- direct printing 63

Protect 84

PV-14 72, 120

Q

Quick startup 89

R

Red-eye reduction 25

Reset all 100

RSCN 103

S

Self-timer 26

Self-timer lamp 4

Set up menu 87

Shooting menu 73

Shutter-release button 4, 20, 21

Slide show 83

Small picture 45

Sound settings 96

Speaker 4

Sports 32

SSCN 103

Strap, camera 4

Sunset 33

T

- Television 58
 - connecting to 58
- Time zone 12, 90
 - time zone list 92
- Transfer
 - marking pictures for, 62
- Transfer marking 85, 99
- Transferring pictures 61
- Tripod 5

U

- USB 60, 62, 64, 99
 - cable (UC-E6) 59, 61, 64

V

- Video mode 99
- Voice memos 46
- Voice recording 52
 - copying 56
 - playing 54
- Volume 51

W

- WAV 103
- Welcome screen 89
- White balance 76

Z

- Zoom 18
 - digital 18, 19
 - optical 18
 - playback 41
- Zoom buttons 5, 51

Nikon

No reproduction in any form of this manual, in whole or in part (except for brief quotation in critical articles or reviews), may be made without written authorization from NIKON CORPORATION.



NIKON CORPORATION

Fuji Bldg., 2-3 Marunouchi 3-chome,
Chiyoda-ku, Tokyo 100-8331, Japan

YP6L01(11)
6MA25711--