



KONICA MINOLTA

DiMAGE X21



E INSTRUCTION MANUAL

BEFORE YOU BEGIN

Thank you for purchasing this product. Please take the time to read through this instruction manual so you can enjoy all the features of your new digital camera.

Check the packing list before using this product. If any items are missing, immediately contact your camera dealer.

Konica Minolta DiMAGE X21 digital camera
AA-size alkaline batteries
Hand strap HS-DG 120
SD Memory Card
USB cable USB-500
DiMAGE Instruction Manuals CD-ROM
Quick Reference Guide
International Warranty Certificate
DiMAGE Viewer CD-ROM

Konica Minolta is a trademark of Konica Minolta Holdings, Inc. DiMAGE is a trademark of Konica Minolta Camera, Inc. Apple, Macintosh, and Mac OS are registered trademarks of Apple Computer Inc. Microsoft and Windows are registered trademarks of the Microsoft Corporation. The official name of Windows is Microsoft Windows Operating System. Pentium is a registered trademark of the Intel Corporation. QuickTime is a trademark used under license. PictBridge and the PictBridge logo are trademarks of the Camera & Imaging Products Association (CIPA). All other trademarks are the property of their respective owners. All other brand and product names are trademarks or registered trademarks of their respective owners.

FOR PROPER AND SAFE USE

Read and understand all warnings and cautions before using this product.

WARNING

Using batteries improperly can cause them to leak harmful solutions, overheat, or explode which may damage property or cause personal injury. Do not ignore the following warnings.

- Only use the batteries specified in this instruction manual.
- Do not install the batteries with the polarity (+/-) reversed.
- Do not use batteries which show wear or damage.
- Do not expose batteries to fire, high temperatures, water, or moisture.
- Do not attempt to short or disassemble batteries.
- Do not store batteries near or in metallic products.
- Do not mix batteries of different types, brands, ages, or charge levels.
- Do not charge alkaline batteries.
- When recharging rechargeable batteries, only use the recommended charger.
- Do not use leaking batteries. If fluid from the batteries enters your eye, immediately rinse the eye with plenty of fresh water and contact a doctor. If fluid from the batteries makes contact with your skin or clothing, wash the area thoroughly with water.
- Tape over battery contacts to avoid short-circuiting during disposal; always follow local regulations for battery disposal.

- Use only the specified AC adapter within the voltage range indicated on the adapter unit. An inappropriate adapter or current may cause damage or injury through fire or electric shock.
- Only use the adapter power cord in the sales region for which it was designed. An inappropriate current may cause damage or injury through fire or electric shock.
- Do not disassemble this product. Electric shock may cause injury if a high voltage circuit inside the product is touched.
- Immediately remove the batteries or unplug the AC adapter and discontinue use if the camera is dropped or subjected to an impact in which the interior, especially the flash unit, is exposed. The flash has a high voltage circuit which may cause an electric shock resulting in injury. The continued use of a damaged product or part may cause injuries or fire.
- Keep batteries or small parts that could be swallowed away from infants. Contact a doctor immediately if an object is swallowed.
- Store this product out of reach of children. Be careful when around children not to harm them with the product or parts.
- Do not fire the flash directly into the eyes. It may damage eyesight.
- Do not fire the flash at vehicle operators. It may cause a distraction or temporary blindness which may lead to an accident.
- Do not use the monitor while operating a vehicle or walking. It may result in injury or an accident.

- Do not use this product in a humid environment, or operate this product with wet hands. If liquid enters the product, immediately remove the batteries or unplug the AC adapter and discontinue use. The continued use of a product exposed to liquids may cause damage or injury through fire or electric shock.
- Do not use the product near inflammable gases or liquids such as gasoline, benzine, or paint thinner. Do not use inflammable products such as alcohol, benzine, or paint thinner to clean the product. The use of inflammable cleaners and solvents may cause an explosion or fire.
- When unplugging the AC adapter, do not pull on the power cord. Hold the plug when removing it from an outlet.
- Do not damage, twist, modify, heat, or place heavy objects on the AC adapter cord. A damaged cord may cause damage or injury through fire or electric shock.
- If the product emits a strange odor, heat, or smoke, discontinue use. Immediately remove the batteries taking care not to burn yourself as the batteries become hot with use. The continued use of a damaged product or part may cause injuries or fire.
- Take the product to a Konica Minolta service facility when repairs are required.
- Handling the cord on this product will expose you to lead, a chemical known to the States of California to cause cancer, and birth defects or other reproductive harm. Wash hands after handling.

CAUTION

- Do not use or store the product in a hot or humid environment such as the glove compartment or trunk of a car. It may damage the product and batteries which may result in burns or injuries caused by heat, fire, explosion, or leaking battery fluid.
- If batteries are leaking, discontinue use of the product.
- The camera temperature rises with extended periods of use. Care should be taken to avoid burns.
- Burns may result if the memory card or batteries are removed immediately after extended periods of use. Turn the camera off and wait for it to cool.
- Do not fire the flash while it is in contact with people or objects. The flash unit discharges a large amount of energy which may cause burns.
- Do not apply pressure to the LCD monitor. A damaged monitor may cause injury, and the liquid from the monitor may cause inflammation. If liquid from the monitor makes contact with skin, wash the area with fresh water. If liquid from the monitor comes in contact with the eyes, immediately rinse the eyes with plenty of water and contact a doctor.
- When using the AC adapter, insert the plug securely into the electrical outlet.
- Do not use the electronic transformers or travel adapters with the adapter. The use of these devices may cause a fire or damage the products.
- Do not use if the AC adapter cord is damaged.
- Do not cover the AC adapter. A fire may result.
- Do not obstruct access to the AC adapter; this can hinder the unplugging of the unit in emergencies.
- Unplug the AC adapter when cleaning or when the product is not in use.

The following marks may be found on the product:



This mark on your camera certifies that this camera meets the requirements of the EU (European Union) concerning interference causing equipment regulations. CE stands for Conformité Européenne (European Conformity).

This Class B digital apparatus complies with Canadian ICES-003.



FCC Compliance Statement
Declaration on Conformity

Responsible Party: Konica Minolta Photo Imaging U.S.A. Inc.
Address: 725 Darlington Avenue, Mahwah, NJ 07430

This device complies with Part 15 of the FCC Rules. Operation is subject to the following two conditions: (1) This device may not cause

harmful interference, and (2) this device must accept any interference received, including interference that may cause undesired operation. Changes or modifications not approved by the party responsible for compliance could void the user's authority to operate the equipment. This equipment has been tested and found to comply with the limits for a Class B digital device, pursuant to Part 15 of the FCC Rules. These limits are designed to provide reasonable protection against harmful interference in a residential installation.

This equipment generates, uses and can radiate radio frequency energy and, if not installed and used in accordance with the instructions, may cause harmful interference to radio communications. However, there is no guarantee that interference will not occur in a particular installation. If this equipment does cause harmful interference to radio or television reception, which can be determined by turning the equipment off and on, the user is encouraged to try to correct the interference by one or more of the following measures:

- Reorient or relocate the receiving antenna.
- Increase the separation between the equipment and the receiver.
- Connect the equipment to an outlet on a circuit different from that to which the receiver is connected.
- Consult the dealer or an experienced radio/TV technician for help.

Do not remove the ferrite cores from the cables.

TABLE OF CONTENTS

The getting up and running section covers how to prepare the camera for use. It contains important information about power supplies and memory cards. The basic operation of this camera is covered in the recording - basic operation section between pages 22 and 31, and the playback - basic operation section between pages 32 and 35. Read the data-transfer mode section in its entirety before connecting the camera to a computer.

Many of the features of this camera are controlled with menus. The menu navigation sections concisely describe how to change menu settings. Descriptions of the settings immediately follow the navigation sections.

The appendix contains a troubleshooting section to help answer questions about the operation of the camera. Information covering camera care and storage is also provided. Please store this manual in a safe place.

| | |
|--|----|
| Names of parts | 12 |
| Getting up and running | 14 |
| Inserting the batteries | 14 |
| Battery-condition indicator..... | 15 |
| Auto power off..... | 15 |
| AC adapter (sold separately)..... | 16 |
| Attaching the strap | 17 |
| Installing and removing a memory card..... | 18 |
| About memory cards..... | 19 |
| Setting the date and time..... | 20 |
| Recording - basic operation | 22 |
| Handling the camera | 22 |
| Setting the camera to record images..... | 22 |
| Using the zoom lens..... | 23 |
| LCD monitor display - basic | 24 |
| Camera-shake warning | 24 |
| Basic recording operation | 25 |
| Focus lock | 26 |
| Focus range..... | 26 |
| Focus signals | 27 |
| Special focusing situations | 27 |
| Flash signals..... | 28 |
| Flash range - automatic operation..... | 29 |
| LCD monitor display - recording mode | 30 |
| Self-portrait mirror..... | 31 |

| | |
|--|----|
| Playback - basic operation | 32 |
| Single-frame playback display | 32 |
| Viewing images | 33 |
| Deleting single images | 33 |
| LCD monitor display - playback mode | 34 |
| Enlarged playback | 35 |
| Recording - advanced operation | 36 |
| LCD monitor display - advanced | 36 |
| Navigating the main recording menu | 36 |
| Flash modes | 38 |
| Drive modes | 40 |
| Self-timer | 41 |
| Continuous advance | 42 |
| Multi frame | 43 |
| White balance | 44 |
| Image quality | 45 |
| Exposure compensation | 47 |
| Colour modes | 48 |
| Portrait | 49 |
| Special effects | 50 |
| Adding a frame or border | 50 |
| Creating side-by-side images | 51 |
| Navigating the advanced recording menu | 52 |
| Controller customization | 54 |
| Auto reset | 55 |
| Date imprinting | 56 |
| Digital zoom | 57 |
| File number (#) memory | 58 |
| Folder name | 58 |
| Instant playback | 59 |
| Movie recording | 60 |
| Navigating the main movie recording menu | 61 |
| Notes on movie recording | 62 |
| Playback - advanced operation | 63 |
| Playing back movies | 63 |
| Navigating the main playback menu | 64 |
| Navigating the advanced playback menu | 65 |
| Frame-selection screen | 67 |
| Deleting image files | 68 |
| Locking image files | 69 |
| Adding to Favorites | 70 |
| Viewing Favorites | 71 |
| Rotate | 72 |
| Slide show | 73 |
| About DPOF | 74 |
| Creating a DPOF print order | 74 |
| Ordering an index print | 76 |
| Date printing | 76 |
| E-mail copy | 77 |

| | |
|--|-----|
| Setup menu | 78 |
| Navigating the setup menu | 78 |
| LCD monitor brightness | 82 |
| Formatting memory cards | 82 |
| Reset default | 83 |
| Language..... | 84 |
| Audio signals..... | 84 |
| Focus signal | 85 |
| Shutter signal | 85 |
| Auto power off..... | 85 |
| Date and time..... | 86 |
| Date format..... | 86 |
| Transfer mode | 86 |
| Data-transfer mode..... | 87 |
| System requirements | 87 |
| Connecting the camera to a computer..... | 88 |
| Connecting to Windows 98 and 98SE | 90 |
| Automatic installation | 90 |
| Manual installation..... | 91 |
| QuickTime system requirements..... | 93 |
| Auto power off - data-transfer mode | 93 |
| Memory card folder organization | 94 |
| Disconnecting the camera from the computer | 96 |
| Windows 98 and 98SE | 96 |
| Windows Me, 2000 Professional, and XP | 96 |
| Macintosh | 97 |
| Changing the memory card - data-transfer mode..... | 98 |
| Using PictBridge | 98 |
| Notes on printing errors | 100 |
| Navigating the PictBridge menu | 100 |
| Batch print | 102 |
| Index print..... | 102 |
| Paper size | 102 |
| Sizes | 102 |
| Layout | 102 |
| Print quality | 102 |
| Data print | 102 |
| Printing DPOF files | 103 |
| Appendix | 104 |
| Troubleshooting | 104 |
| Removing the driver software - Windows..... | 106 |
| Care and storage..... | 107 |
| Technical specifications | 110 |

NAMES OF PARTS

* This camera is a sophisticated optical instrument. Care should be taken to keep these surfaces clean. Please read the care and storage instructions in the back of this manual (p. 107).

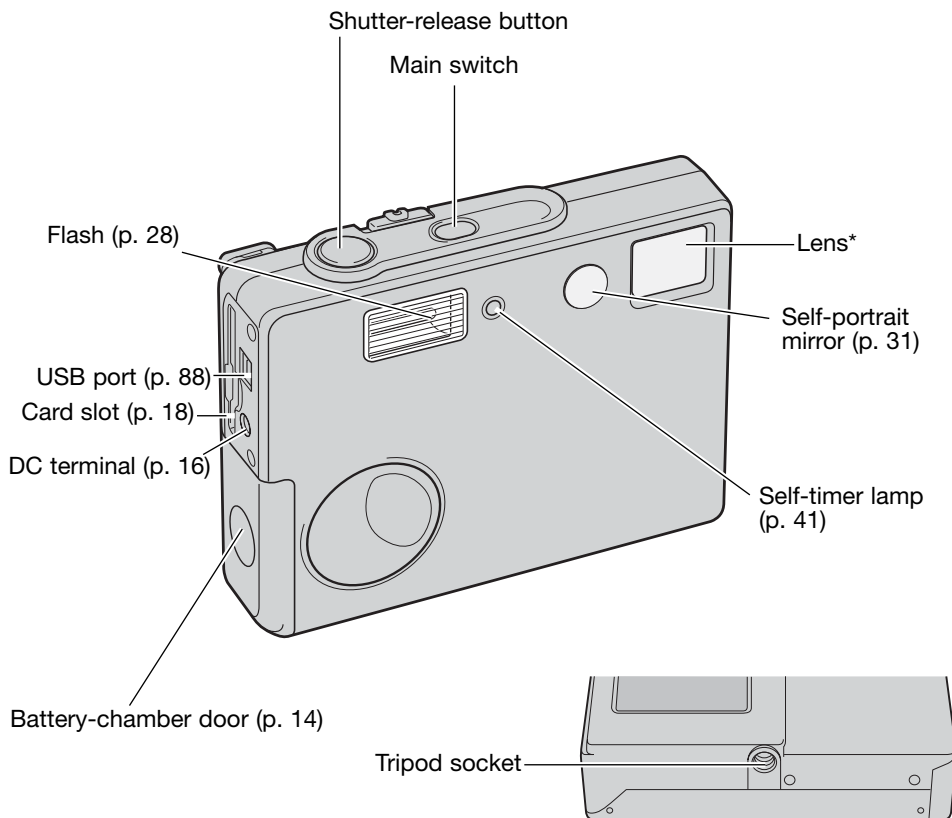

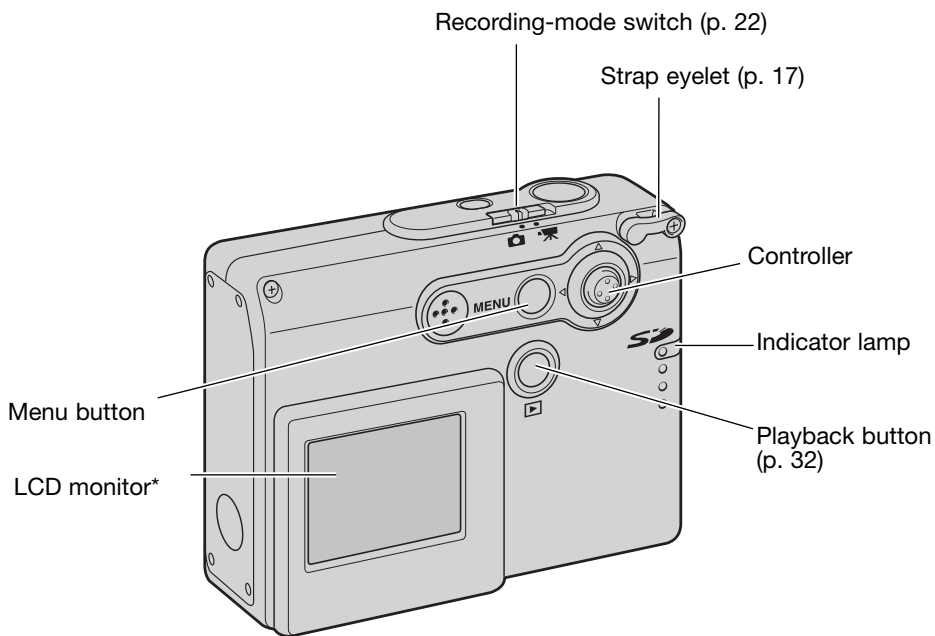

GETTING UP AND RUNNING

INSERTING THE BATTERIES

This digital camera uses two AA-size alkaline batteries or Ni-MH batteries. AA-size Ni-MH batteries are recommended because of longer life. Do not use other types of batteries with this camera. When using Ni-MH batteries, fully recharge them with a battery charger suitable for complex electronic equipment. Please consult your vendor about an appropriate charger. When replacing the batteries, the camera should be turned off.

Slide the battery-chamber door toward the front of the camera to release the safety catch (1). Open the door.

Insert the AA batteries as shown; make sure the positive and negative battery terminals are oriented correctly (2).

Close the battery-chamber door and slide it toward the back of the camera to engage the safety catch.

After installing the batteries, the set-date/time message may appear on the monitor. Set the date and time following the instructions in page 20. The clock and calendar can also be set in section 3 of the setup menu. If the camera is not used for several hours after the batteries are taken out, the clock, calendar, and memory settings are lost.

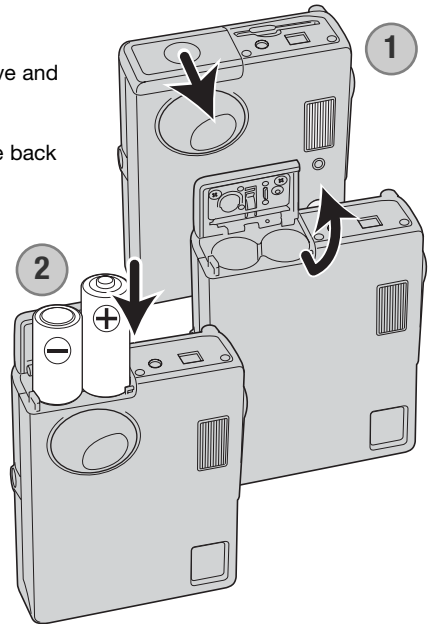

BATTERY-CONDITION INDICATOR

This camera is equipped with an automatic battery-condition indicator displayed on the LCD monitor. The indicator will change from white to red when battery power is low.



Full-battery indicator - the battery is fully charged. This is displayed when the camera is on.



Low-battery indicator - the battery power is low. The batteries should be replaced as soon as possible. This is displayed when the camera is turned on.



Low-battery warning - battery power is very low. The batteries must be replaced soon. The LCD monitor will turn off when the flash is charging. This warning automatically appears and remains on the monitor until the batteries are replaced. If the power level falls below this level when the camera is on, the battery-exhausted message will appear just before the camera shuts down.

If power is insufficient for camera operation, LCD monitor will be blank and the shutter will not release. Change the batteries.

AUTO POWER OFF

To conserve battery power, the camera will shut down if an operation is not made within three minutes. To restore power, press the main switch. The length of the auto-power-off period can be changed in section 2 of the setup menu (p. 85). When the camera is connected to a computer, the auto-power-off period is set to ten minutes and cannot be changed.

AC ADAPTER (SOLD SEPARATELY)



Always turn off the camera before changing between power supplies.

The AC adapter AC-12U, 12E, or 12GB allows the camera to be powered from a household outlet. The AC adapter is recommended when the camera is interfaced with a computer or during periods of heavy use.

AC adapter model AC-12U is for use in North America and Canada, AC-12E is for use in European continent, and AC-12GB is for use in United Kingdom and HongKong.

Never connect the AC adapter to the camera while the camera is on.

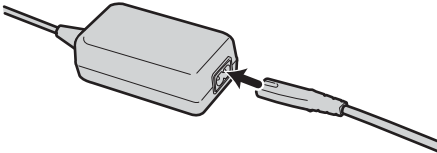

Connect the power cord to the AC adapter unit.

Insert the power cord securely into an electrical outlet.

Insert the AC adapter's output plug securely into the camera's DC terminal.

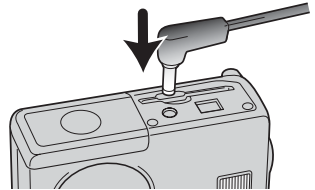

ATTACHING THE STRAP

Always keep the strap around your wrist in the event that the camera is accidentally dropped.

Pass the small loop of the hand strap through the strap eyelet on the camera body.

Pass the other end of the strap through the small loop and tighten.

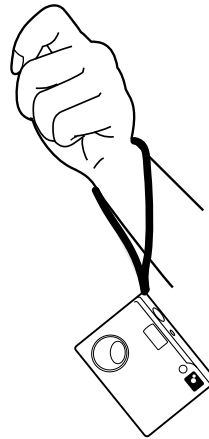
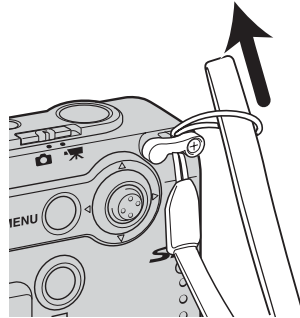
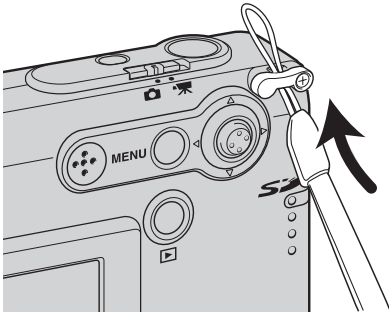

INSTALLING AND REMOVING A MEMORY CARD



Always turn off the camera and confirm the indicator lamp is not red and blinking before changing the memory card, otherwise the card may be damaged, and data lost.

An SD (Secure Digital) Memory card or MultiMediaCard must be inserted for the camera to operate. If a card has not been inserted, a no-card warning will appear on the LCD monitor; the shutter can still be released and a single image can be captured.

Insert the memory card all the way into the card slot and then release. The card should catch in the slot.

Insert the card. Make sure the face of the card is toward the front of the camera. Always push the card in straight, never at an angle. Never force the card. If the card does not fit, check that it is orientated correctly.

To eject a memory card, press the card into the slot and release. The card can now be pulled out.

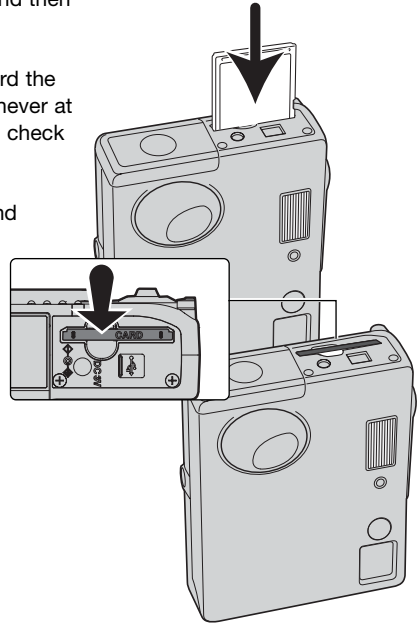

ABOUT MEMORY CARDS

The response time during recording and playback is longer with MultiMediaCards compared with SD Memory Cards. This is not a defect, but rather due to the specifications of the cards. When using large capacity cards, some operations like deletion may take longer.

The SD Memory Card has a write-protect switch to prevent image data from being deleted. By sliding the switch to the bottom of the card, the data will be protected. However, when the card is protected, images cannot be recorded. If an attempt is made to record or delete an image with the camera, the card-locked message will appear and the LED lamp near the card slot will turn red and blink quickly. For memory card care and store see page 108.

If the unable-to-use-card message appears, the inserted card in the camera may need to be formatted. A card used in another camera may also have to be formatted before being used. A card can be formatted in section 1 of the setup menu (p. 82). When a card is formatted, all the data on the card is permanently erased.

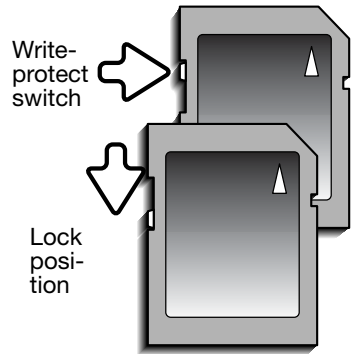

SETTING THE DATE AND TIME

After initially inserting a memory card and charging the battery, the camera's clock and calendar must be set. When images are recorded, the image data is saved with the date and time of recording. The date and time may also have to be set when changing batteries if the clock and calendar reset. Depending on the region, the menu language may also have to be set. To change the language, see the camera notes on the following page.

Turn the camera on by pressing the main switch near the shutter-release button (1).

The set-date-and-time message appears on the LCD monitor. Select "Yes" by pressing the controller.

Controller

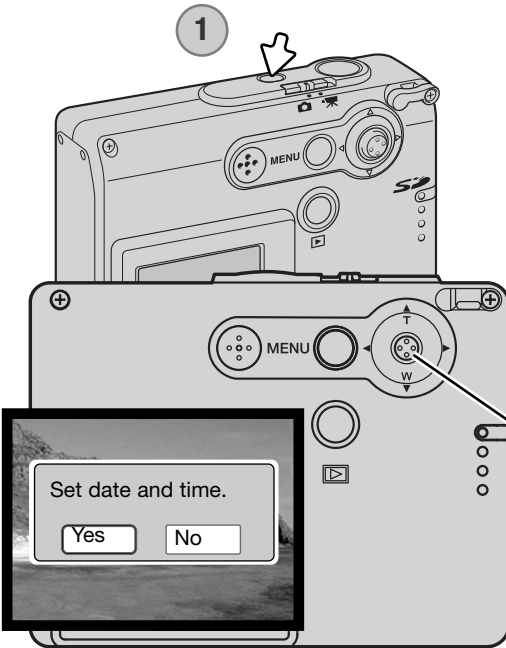

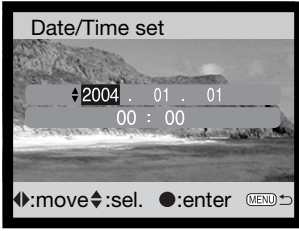

The date/time setting screen appears. Set the date and time using the controller on the back of the camera.



Move the controller left and right to select the item to be changed.



Move the controller up and down to adjust the item.



Press the controller to set the clock and calendar.

Date and time can also be set in section 3 of the setup menu. See page 78 on how to open the setup menu.

Camera notes

For customers in certain areas, the menu language must also be set. Highlight the language option in section 1 of the setup menu (p.78). Push the controller right to display the language settings. Move the controller up or down to select the desired language. Press the controller to set the language; the setup menu will be displayed in the selected language.

RECORDING - BASIC OPERATION

This section covers basic recording operation. To prepare the camera for use, read pages 14 through 21.

HANDLING THE CAMERA

While using LCD monitor, grip the camera firmly with your right hand while supporting the camera body with your left. Keep your elbows at your side and your feet shoulder-width apart to hold the camera steadily.

When taking vertical pictures, hold the camera so that the flash is above the lens with the shutter-release button to the top. Take care not to cover the lens with your fingers or the strap.



SETTING THE CAMERA TO RECORD IMAGES

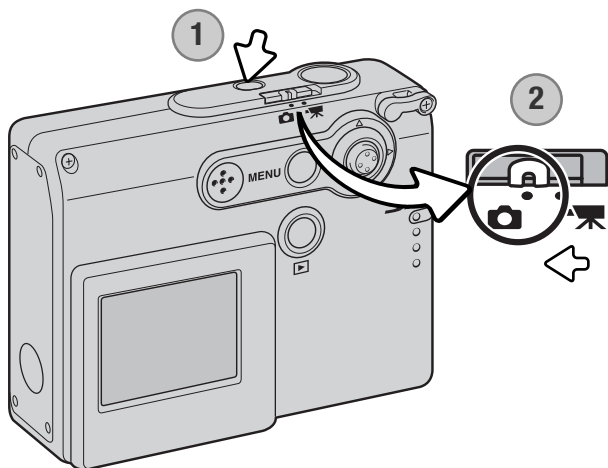

Turn the camera on by pressing the main switch near the shutter-release button (1).

Slide the recording-mode switch to the recording-mode position (2). It is the default setting.

USING THE ZOOM LENS

This camera is equipped with a unique 4.8 - 14.4mm zoom lens. This is equivalent to a 37 to 111mm lens on a 35mm camera. The lens is operated by the controller at the back of the camera. While zooming, the zoom scale is displayed on the LCD monitor.

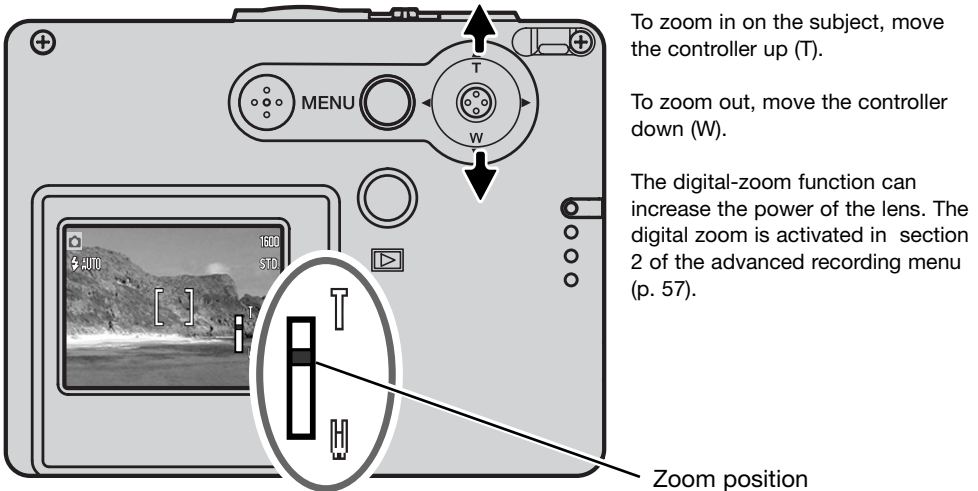

Shooting tips

The zoom lens not only affects how large the subject is in the picture, but it also influences the depth of field and perspective. Depth of field is the area between the closest object in focus and the furthest object in focus. As the lens zooms in to the telephoto position, the depth of field becomes shallower, separating the subject from the background. Many portraits are taken with telephoto lenses. Zooming the lens out to the wide-angle position makes both the foreground and background appear sharper. Usually landscape photographs take advantage of the large depth of field of wide-angle lenses. Wide-angle lenses also create a strong perspective which gives a sense of depth in the image. Telephoto lenses compress the space between the subject and background and create a weak perspective.

LCD MONITOR DISPLAY - BASIC

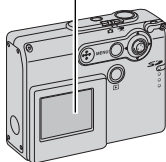
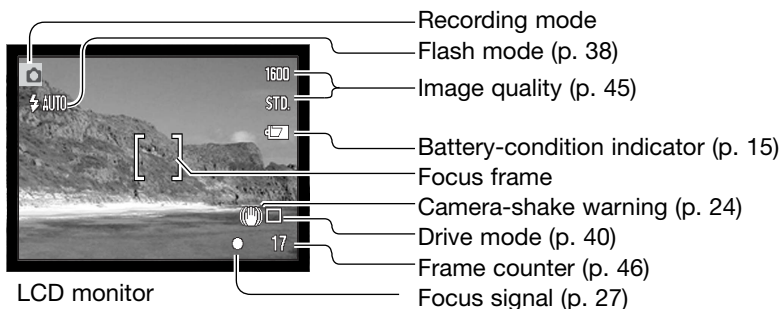

CAMERA-SHAKE WARNING



If the shutter speed falls below the point where the camera can be hand held safely, the camera-shake warning indicator will appear on the monitor. Camera shake is slight blurring caused by subtle hand motion and is more pronounced at the telephoto position of the lens than at the wide-angle position. Although the warning appears, the shutter can still be released. If the warning appears, place the camera on a tripod or use the built-in flash.



BASIC RECORDING OPERATION

Turn the camera on and slide the recording-mode switch to the recording position.

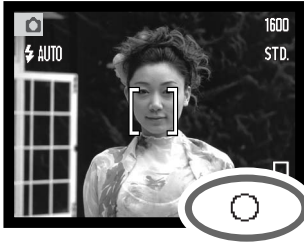

Place the subject within the focus frame on the LCD monitor.

- The focus-lock function (p. 26) can be used with off-center subjects.

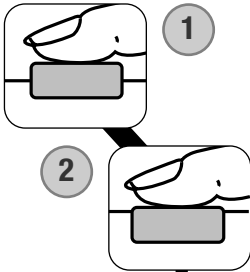

Press the shutter-release button partway down (1) to lock the focus and exposure.

- The focus signals (p. 27) on the monitor will confirm that the image is in focus. If the monitor focus signal is red, the camera was unable to focus on the subject. Repeat the previous steps until the focus signal is white.
- If the battery power is very low, the LCD monitor turns off when flash charges.

Press the shutter-release button all the way down (2) to take the picture.

- After the shutter releases, the indicator lamp next to the card slot will turn red and blink indicating image data is being written to the memory card. Never remove a memory card while data is being transferred.
- The image can be previewed after it is captured by continuing to hold down the shutter-release button (p. 59).

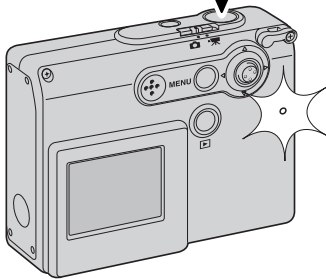

FOCUS LOCK

The focus-lock function is used when you want to compose the image with the subject off-center and outside the focus frame. Focus lock may also be used when a special focusing situation prevents the camera from focusing on the subject. This function is controlled with the shutter-release button.

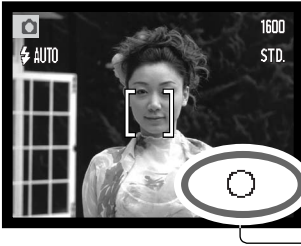

Place the subject within the focus frame. Press and hold the shutter-release button partway down to lock the focus.

- The focus signal on the monitor will indicate if the focus is locked.



Without lifting your finger from the shutter-release button, recompose the subject within the image area. Press the shutter-release button all the way down to take the picture.

FOCUS RANGE

The focus range is 10cm (0.3ft.) to infinity.

FOCUS SIGNALS

This digital camera has a quick, accurate autofocus system. The focus signal in the lower right corner of the LCD monitor indicates the focus status. The shutter can be released regardless if the camera can focus on the subject or not.

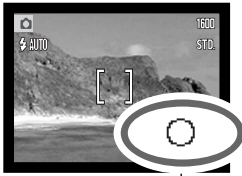

Focus signal

Focus confirmed - the LCD monitor focus signal is white. Focus is locked.

Cannot focus - the LCD monitor focus signal is red.

SPECIAL FOCUSING SITUATIONS

The camera may not be able to focus in certain situations. In these situations the focus-lock function (p. 26) can be used to focus on another object at the same distance as your main subject, and then the image can be recomposed to take the picture.

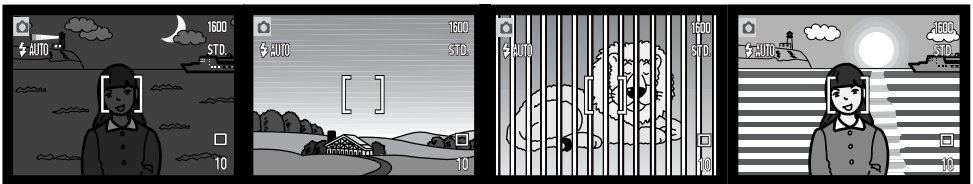

The subject is too dark.

The subject in the focus frame is low in contrast.

Two subjects at different distances overlap in the focus frame.

The subject is near a very bright object or area.

FLASH SIGNALS

The flash mode indicator of the LCD monitor indicates the flash status, when the shutter-release button is pressed partway down. While the flash is charging, the shutter cannot be released.

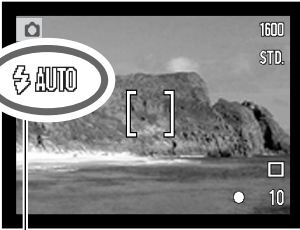

Flash mode indicator

- Flash charging -** Flash mode indicator is red. Shutter is locked.
- Flash ready -** Flash mode indicator is white.

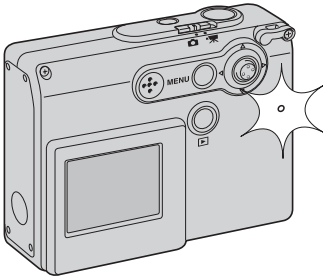

If battery power is very low, the LCD monitor turns off when the flash is charging. The indicator lamp next to the card slot will turn orange and blink quickly when the flash is charging.

FLASH RANGE - AUTOMATIC OPERATION

The camera automatically controls the flash output. For well-exposed images, the subject must be within the flash range. Because of the optical system, the flash range is not the same at the lens' wide-angle position as it is at the telephoto position.

Wide-angle position

0.2m ~ 3.6m (0.7 ft. ~ 11.8 ft.)

Telephoto position

0.2m ~ 2.7m (0.7 ft. ~ 8.9 ft.)

When photographing a subject closer than 20 cm (0.7 ft.), use flash cancel, see page 39.

LCD MONITOR DISPLAY - RECORDING MODE

Pressing and holding the controller switches the LCD monitor display between full display and live image only.

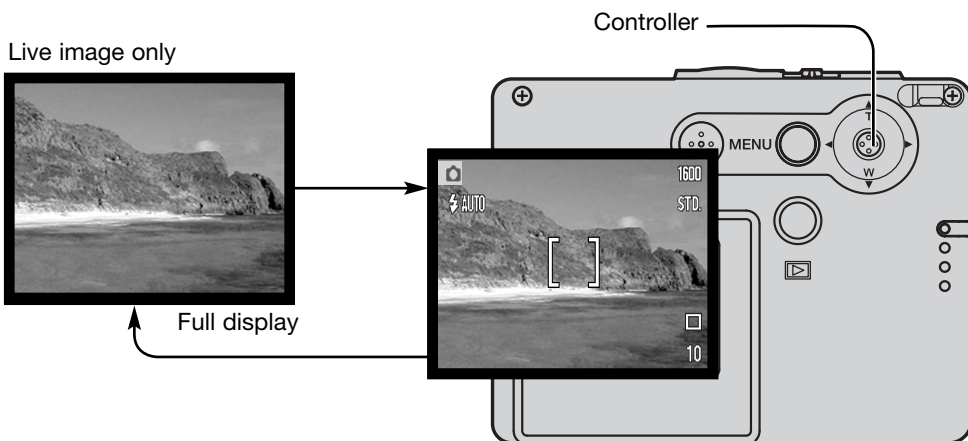

The battery-condition, date-imprinting, and flash-charging indicators can appear on the live image only display. When auto reset is active, the LCD monitor is reset to the full display when the camera is turned off.

SELF-PORTRAIT MIRROR

The self-portrait mirror allows a self-portrait to be taken without the need of the self-timer and a tripod.

Hold the camera at arms length. Center yourself in the mirror next to the lens to point the camera.

Press the shutter-release button partway down to lock focus (1). When activated (p. 85), the focus signal beeps to confirm focus.

Press the shutter-release button all the way down to take the picture (2).

The mirror is a general pointing device suitable when using the lens in the wide-angle position. The actual framing of the image depends on the distance between the camera and subject, and the zoom position. A test picture can be taken to confirm the zoom and camera position.

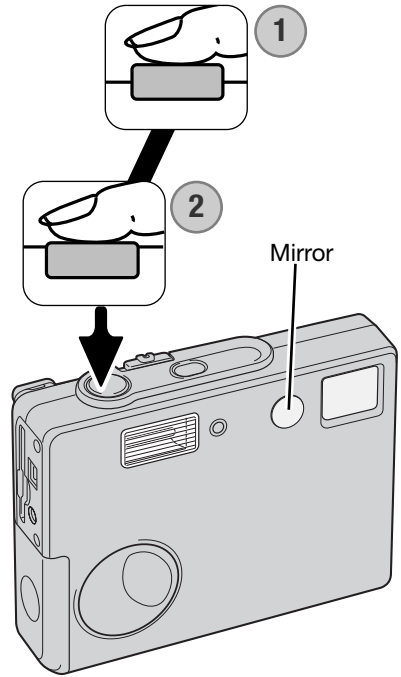

PLAYBACK - BASIC OPERATION

This section covers the basic viewing operation in the playback mode. The playback mode has additional functions, see page 64.

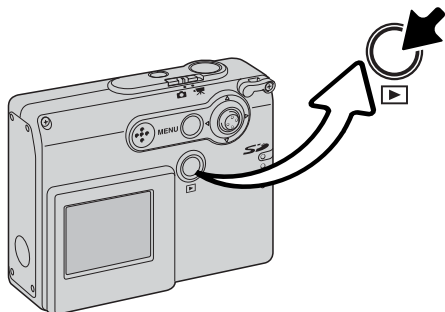

To view images, press the playback button.

To return to the recording mode, press the playback button again. Changing the position of the recording mode switch also cancels the playback mode.

SINGLE-FRAME PLAYBACK DISPLAY

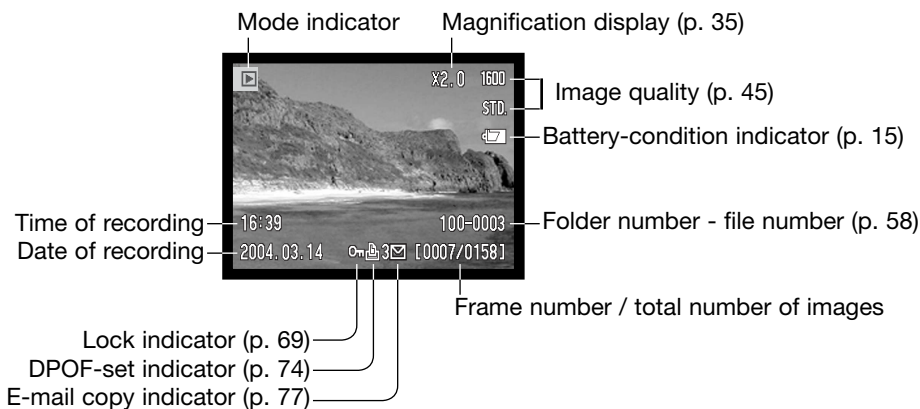

VIEWING IMAGES

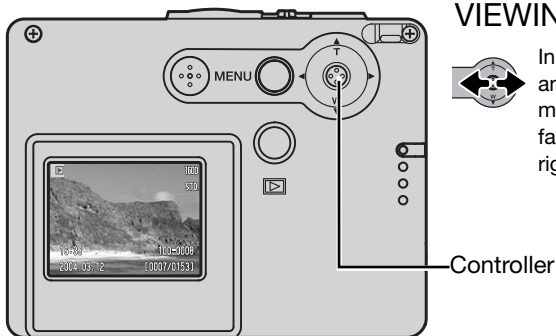

 In the playback mode, move the controller left and right to scroll through the images on the memory card. The images can be scrolled faster by holding the controller to the left or right.

DELETING SINGLE IMAGES

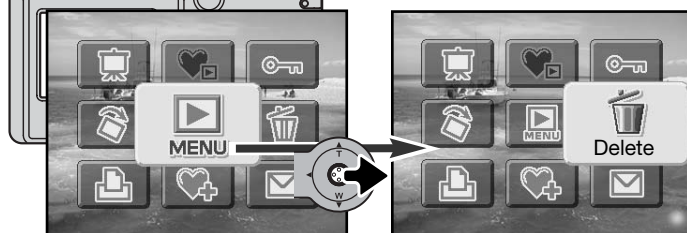
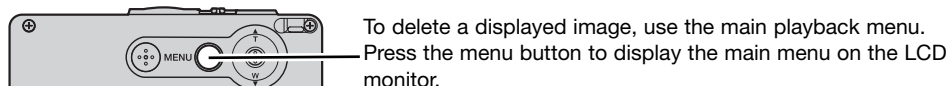

Use the controller to select the delete icon.



Press the controller; a confirmation screen will appear.



Move the controller left and right to highlight “Yes.” “No” will cancel the operation.



Press the controller to delete the file.



LCD MONITOR DISPLAY - PLAYBACK MODE

Pressing and holding the controller switches the LCD monitor display between full display and live image only.

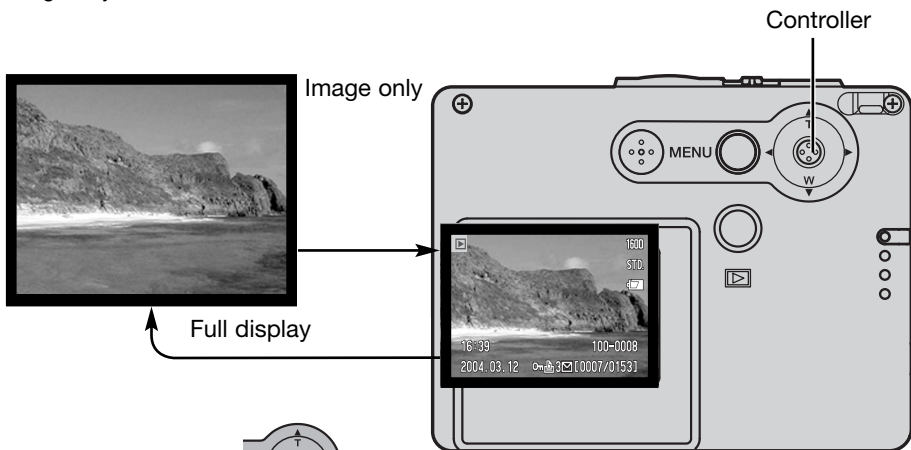

Index playback

Index display can be shown by moving the controller down.

In index playback, pushing the controller left and right moves the yellow border around the index thumbnails. To scroll through the index thumbnails faster, hold the controller to the left or right. When the image is highlighted with the border, the date of recording, the lock and printing status, e-mail copy indicator, and the frame number of the image are displayed at the bottom of the screen. When the controller is moved up, the highlighted image will be displayed in the single-frame playback mode.

ENLARGED PLAYBACK

In single-frame playback, a still image can be enlarged by up to 6X in multiple steps.



With the image to be magnified displayed, move the controller up to activate the enlarged playback mode. The degree of magnification is displayed on the LCD monitor.



Moving the controller up increases the image magnification. Moving the controller down decreases the image magnification.



Pressing and holding the controller switches between showing the full display and image only.

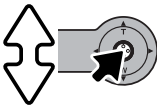

To scroll the image, press the controller. Pressing the controller switches between the enlarged-playback and scroll screens.

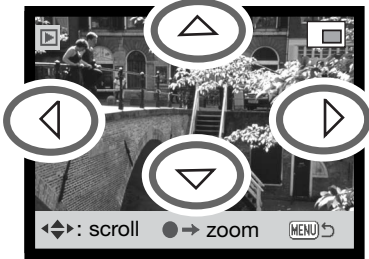

Move the controller to view the image.



To exit the enlarged playback mode, press the menu button.



The locator indicator in the top right corner of the monitor shows the area of the image being displayed.

RECORDING - ADVANCED OPERATION

LCD MONITOR DISPLAY - ADVANCED

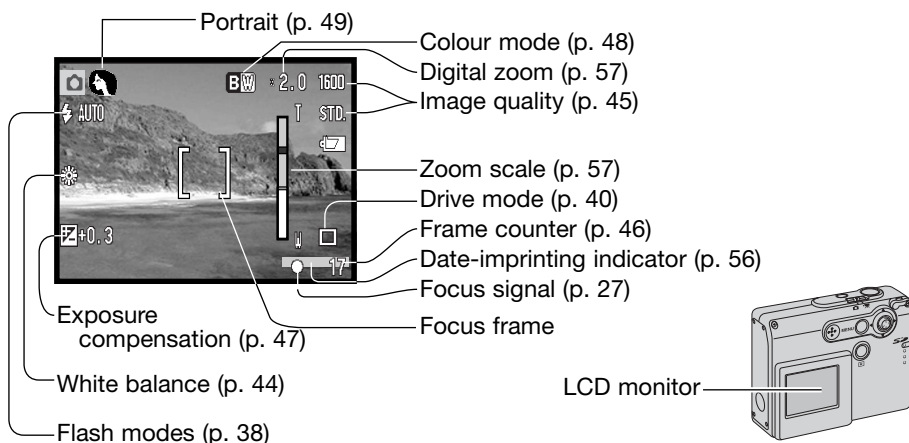

NAVIGATING THE MAIN RECORDING MENU

When the menu button is pressed, the main menu appears on the LCD monitor and the basic menu options can be set. The following nine menu options are available in the main menu of the recording mode.



1. Flash mode (p. 38)
2. Drive mode (p. 40)
3. White balance (p. 44)
4. Image quality (p. 45)
5. Exposure compensation (p. 47)
6. Colour mode (p. 48)
7. Portrait (p. 49)
8. Special effects (p. 50)
9. Menu - to access the advanced recording functions (p. 52).

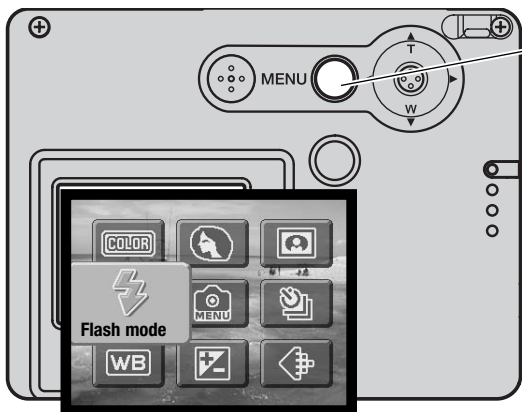

To activate the main menu of the recording mode, press the menu button.



Move the controller in the direction to highlight the appropriate menu option. If the menu icon is struck through, the menu function is disabled.



Press the controller to select the option.

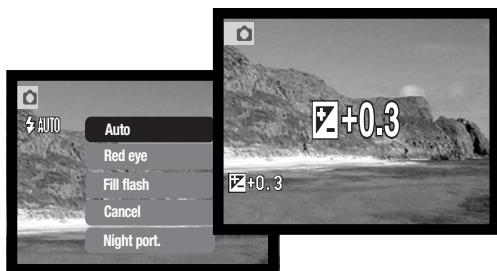

Move the controller up or down to select the new setting or value.



Press the controller to complete the operation and apply the new setting.

Selecting the menu icon in the main menu displays the advanced recording menu where other advanced options are available. To navigate this menu, see page 52.

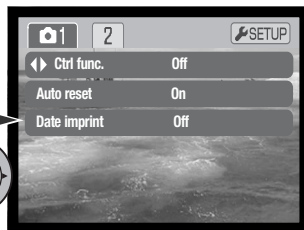

FLASH MODES

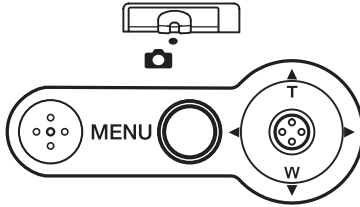
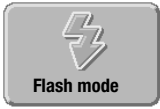





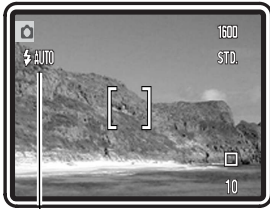

The flash can be used when taking still images. The flash mode is set with the main menu of the recording mode (p. 36). The active flash mode is displayed in the top left corner of the monitor. Flash modes can be assigned to the controller with controller customization (p. 54).

When the camera is turned off and auto reset (p. 55) is active, the flash mode is reset to autoflash or auto-

oflash with red-eye reduction, whichever of these two modes was last used. While the flash is charging, flash mode indicator turns red and the shutter cannot be released.

When photographing a subject closer than 20 cm (0.7 ft.), use flash cancel, see page 39.



| | |
|--|----------------------------------|
|  AUTO | Autoflash |
|  AUTO | Autoflash with red-eye reduction |
|  | Fill-flash |
|  | Flash cancel |
|  | Night portrait |

Autoflash - the flash fires automatically in low-light and backlit conditions.

Red-eye reduction - the flash fires multiple bursts before the main flash burst to reduce red-eye; an effect caused by light reflected from the retina. Use in low-light conditions when taking photographs of people or animals, the pre-flashes contract the pupils of the subject's eyes.

Fill-flash - the flash fires with each exposure regardless of the amount of ambient light. Fill-flash can be used to reduce harsh shadows caused by strong direct light or sunshine.



Flash cancel - the flash will not fire. Use flash cancel when flash photography is prohibited, natural light is desired to illuminate the subject, or the subject is outside the flash range. The camera-shake warning may appear when flash cancel is selected (p. 24).

Night portrait - for flash portraits at night. The camera automatically balances the flash and background exposures. When taking portraits, ask your subject not to move after the flash burst; the shutter will still be open for the background exposure. The red-eye reduction function is used with night portrait. The camera-shake warning may appear when night portrait is selected (p. 24).



DRIVE MODES

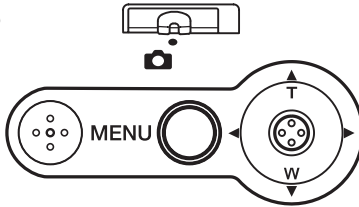

The drive modes control the rate and method images are captured. Indicators indicating the selected drive mode appear on the monitor. The drive mode is set in the main menu of the recording mode (p. 36). If auto reset (p. 55) is active, the drive mode is reset to single-frame advance when the camera is

turned off. Drive modes can be assigned to the controller with controller customization (p. 54).

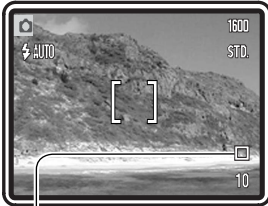

Single-frame advance - to take a single image each time the shutter-release button is pressed. This is the camera's default setting.



Self-timer - to delay the release of the shutter (p. 41). Used for self-portraits.



Continuous advance - to take multiple images when the shutter-release button is pressed and held (p. 42).



Multi frame - to create a composite image of a nine-frame series when the shutter-release button is pressed once (p. 43).

Self-timer



Used for self-portraits, the self-timer will delay the release of the shutter for approximately ten seconds after the shutter-release button is pressed. The self-timer drive mode is set in the main recording menu (p. 36).

With the camera on a tripod, compose the picture as described in the basic recording operation section (p. 25). Focus lock (p. 26) can be used with off-center subjects. Press the shutter-release button partway down to lock the exposure and focus (1). Press the shutter-release button all the way down to begin the countdown (2). Because focus and exposure are determined when the shutter-release button is pressed, do not stand in front of the camera when taking a self-timer image. Always confirm the focus with the focus signals before beginning the countdown (p. 27).

A countdown timer is displayed on the monitor. During the countdown, the self-timer lamp on the front of the camera (3) will start to blink and is accompanied by an audio signal. A few seconds before the exposure, the self-timer lamp will blink rapidly. The lamp will glow steadily just before the shutter fires.

To stop the countdown, move the controller up and down or press the menu button.

The drive mode will be reset to single-frame advance after the exposure. The audio signal can be turned off in section 2 of the setup menu (p. 84).

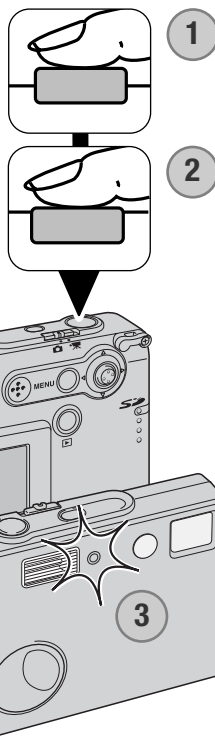

Continuous advance



The continuous-advance drive mode allows a series of images to be captured while holding down the shutter-release button. The number of images that can be captured at one time and the rate of capture depend on the image-quality setting. The maximum rate of capture is 1.2 fps. Continuous-advance drive mode is set in the main recording menu (p. 36).

Compose the picture as described in the basic recording operation section (p. 25). Press the shutter-release button partway down to lock the exposure and focus for the series (1). Press and hold the shutter-release button all the way down (2) to begin taking pictures.

When the shutter-release button is pressed and held, the camera will begin recording images until the maximum number has been taken or the shutter button is released. The built-in flash can be used, but the rate of capture is reduced because the flash must recharge between frames. Date imprinting (p. 56) also reduces the rate of capture.

The maximum number of images that can be captured with different image quality is as follows:

- 1600 X 1200 Fine: 5
- 1600 X 1200 Standard: 7
- 1280 X 960 Standard: 12
- 640 X 480 Standard: 22

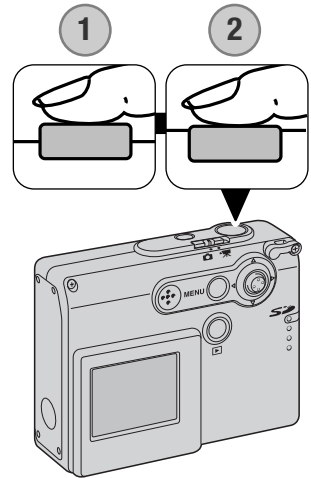

Multi frame



The multi-frame drive mode captures a series of nine consecutive images and lays them out in a single frame. Multi frame drive mode is set in the main recording menu (p. 36)



Compose the picture as described in the basic recording operation section (p. 25). Press the shutter-release button partway down to lock the exposure and focus for the series (1). Press the shutter-release button all the way down (2) to begin the nine-frame series. Once the series starts, the shutter button can be released; the camera will continue taking pictures until all nine frames have been captured.

Flash cannot be used and is canceled automatically. Because of the limits to the shutter speeds in this mode, images may be underexposed in low-light conditions. The digital zoom is not active. The pixel dimensions set in the image-quality menu option refer to the total area of all nine images, not the size of each individual thumbnail.

WHITE BALANCE



White balance is the camera's ability to make different types of lighting appear neutral. The effect is similar to selecting daylight or tungsten film, or using colour compensating filters in conventional photography. One automatic and four preset white-balance settings are available with still image and movie recording. White balance is set in the main recording menu (p. 36) or the movie-recording mode (p. 61). When auto reset (p. 55) is active, the white balance will be reset to automatic white balance when the camera is turned off. White balance can be assigned to the controller with controller customization (p. 54).

The automatic white balance compensates for the colour temperature of a scene. In most cases, the auto setting will balance the ambient light and create beautiful images, even under mixed-lighting conditions. When the built-in flash is used, the white balance is set for the colour temperature of the flash.

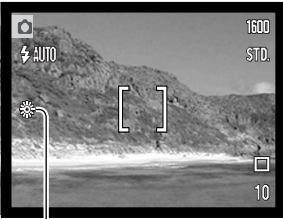

Preset white-balance settings must be set before the image is taken. When one of the preset white-balance settings is selected, an indicator will be displayed on the LCD monitor to indicate the active white-balance setting; the effect is immediately visible on the monitor. To record the ambient light, set the flash mode to flash cancel (p. 39). The built-in flash can be used with preset white-balance, but will create a pinkish or blueish cast with the fluorescent and tungsten settings. The flash is daylight balanced and will produce good results with the daylight and cloudy settings.



Daylight - for outdoor and sunlit subjects.



Cloudy - for overcast outdoor scenes.



Tungsten - for incandescent lighting: household filament light bulbs.



Fluorescent - for fluorescent lighting: office ceiling lights.

IMAGE QUALITY



Image quality must be set before the picture is taken. Four image-quality modes are available; 1600 X 1200 Fine, 1600 X 1200 Standard, 1280 X 960 Standard, and 640 X 480 Standard. Image quality is based on two factors: image size and compression. Changes are displayed on the LCD monitor. Image quality is set in the main recording menu, see page 36.

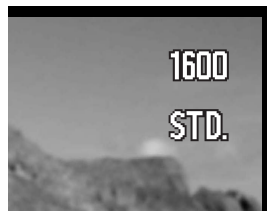

| Image quality | Image size (Number of pixels) | Compression | LCD monitor | |
|----------------------|----------------------------------|-------------|-------------|----------|
| | | | Horizontal | Vertical |
| 1600 X 1200 Fine | 1600 X 1200 | Low | 1600 | FINE |
| 1600 X 1200 Standard | 1600 X 1200 | Standard | 1600 | STD. |
| 1280 X 960 Standard | 1280 X 960 | Standard | 1280 | STD. |
| 640 X 480 Standard | 640 X 480 | Standard | 640 | STD. |

The number in the image-quality option refer to the horizontal and vertical pixel dimensions of the image. The greater the number of pixels, the larger the file size. Choose image size based on the final use of the image - smaller images will be more suitable for web sites whereas larger sizes will produce higher quality prints.

All images are compressed and saved as JPEG files. The compression rate is indicated by FINE and STD (standard). Fine images have a lower compression rate and larger file sizes. Standard is sufficient for normal usage.

If image quality is changed, the frame counter will display the approximate number of images that can be recorded at that setting on the installed memory card. One memory card can contain images with differing image-quality. The number of images that can be stored on a memory card is determined by the size of the card and the file size of the images. The actual file size is determined by the scene; some subjects can be compressed further than others.

The Frame Counter and Memory Card Capacity

The frame counter indicates the approximate number of images that can be stored on the memory card at the camera's image quality settings. If the setting is changed, the frame counter adjusts accordingly. Because the counter uses approximate file sizes, the actual image taken may not change the counter or may decrease it by more than one. When the frame counter displays zero, it indicates no more images at the image-quality setting can be captured. Changing the setting may allow more images to be saved to the card.

| Image quality | Approximate file sizes | Approximate number of images that can be stored on a 8MB memory card |
|----------------------|------------------------|--|
| 1600 X 1200 Fine | 1000 KB | 5 |
| 1600 X 1200 Standard | 540 KB | 11 |
| 1280 X 960 Standard | 380 KB | 16 |
| 640 X 480 Standard | 150 KB | 42 |

EXPOSURE COMPENSATION



The camera exposure can be adjusted to make the final picture lighter or darker by as much as $\pm 2\text{Ev}$ in $1/3$ increments with still image and movie recording. When auto reset (P. 55) is active, exposure compensation is reset to ± 0 when the camera is turned off. Exposure compensation is set in the main menu of the recording mode (p. 36) or the movie-recording mode (p. 61). The exposure-compensation function can be assigned to the controller with controller customization (P. 54).



The exposure compensation must be set before the image is captured. When setting the exposure compensation, the amount of compensation is shown next to the exposure-compensation indicator on the monitor. When set to any value other than 0.0, the exposure-compensation indicator will be displayed on the LCD monitor as a warning.



Move the controller up and down to adjust the exposure-compensation value.

The LCD monitor will display the exposure-compensation indicator and the degree of compensation. The change in exposure is visible in the live image.

COLOUR MODES



Colour, black and white, sepia, posterization, and soft-focus settings are available. The colour mode is set in the main menu of the recording mode (p. 36) or the movie-recording mode (p. 61).

Soft focus cannot be selected in the movie-recording mode or used with special effects, continuous advance, or multi-frame. If the drive mode is set to continuous-advance or multi frame before selecting the soft-focus mode, drive mode is set temporarily to single-frame advance.

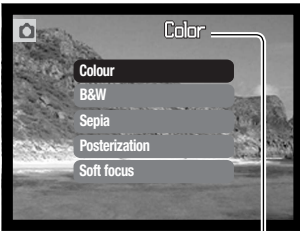

The colour option must be set before an image is captured. When the colour, black and white, sepia, or posterization settings is highlighted, the effect is immediately visible on the monitor. Except for the colour mode, an indicator is displayed on the LCD monitor to indicate the active setting.

When auto reset (P. 55) is active, the setting will be reset to colour when the camera is turned off.



Black and white - neutral monochrome image



Sepia - warm tone monochrome image



Posterization - exaggerated high-contrast images.



Soft focus - images with a soft glow around highlights.

PORTRAIT

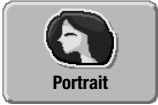

In portrait, the camera is optimized to reproduce warm, soft skin tones and a slight defocusing of the background. Portrait is set in the main recording menu (p. 36)

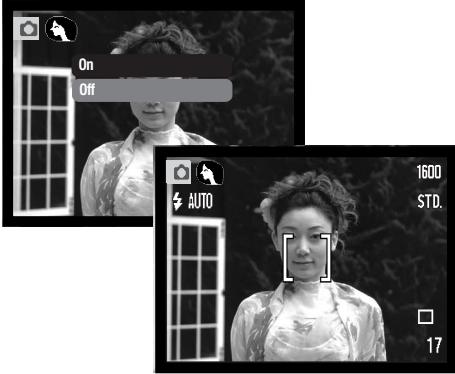

An indicator is displayed on the LCD monitor to show the portrait mode is active.

When auto reset is active (p. 55), the portrait mode is canceled when the camera is turned off.

SPECIAL EFFECTS

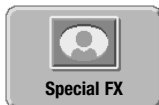

The special-effects option in the main menu adds frames and borders to images or combines two images side by side. Required menu functions should be set before selecting the special effects icon on the menu. Once the special-effects routine begins, menu functions cannot be changed until the operation is completed. The continuous-advance and multi-frame drive modes are temporarily set to single-frame advance.

Adding a frame or border

An image can be captured with a frame or border using the special-effects option in the main recording menu (p. 36).



After the special effects icon is selected, a menu is displayed with the special effects options. Move the controller up and down to select the appropriate option (1). As each option is highlighted, the background frame or border changes accordingly. Press the controller to select the highlighted option (2). Pressing the menu button cancels the operation; the live image is displayed.

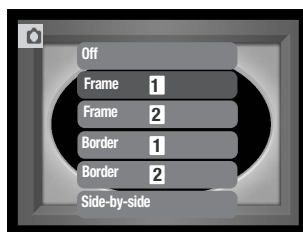

Compose the subject within the frame or border. Take the picture as described in the basic recording section (p. 25).

Processing starts after the shutter releases. The processing time depends on the image-quality mode. When completed, the live image is displayed.



Creating side-by-side images



Two images can be captured side by side using the special-effects option in the main recording menu (p. 36).

After the special effects icon is selected, a menu is displayed with the special effects options. Move the controller up and down to select the side-by-side option (1). Press the controller to select the highlighted option (2). Pressing the menu button cancels the operation; the standard live image is displayed.



Compose the picture within the left half of the live image. Place the subject within the focus frame, then take the picture as described in the basic recording section (p. 25).



The first image is displayed on the left and a live image on the right. Place the subject within the focus frame, then take the picture as described in the basic recording section to complete the operation.

Processing starts after the shutter releases. When completed, the live image is displayed.

NAVIGATING THE ADVANCED RECORDING MENU

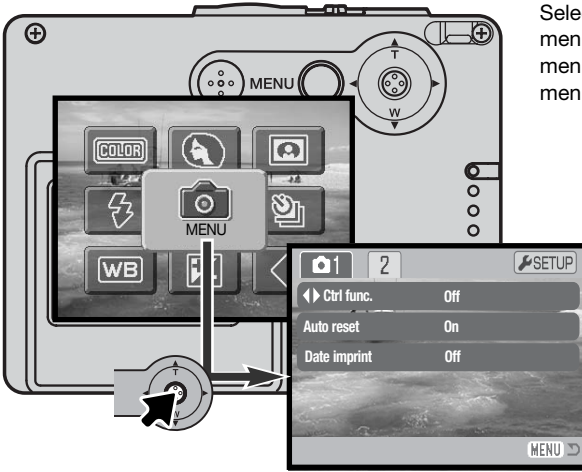



Selecting the menu icon on the main menu displays the advanced recording menu. See page 36 to navigate the main menu.

Navigating the advanced recording menu is simple. Push the controller in the direction to move the cursor and change settings on the menu. Pressing the controller selects menu options and sets adjustments.

 To activate the recording-mode main menu, press the menu button.

 With the menu icon selected, press the controller to go into the advanced recording menu.

 The tab 1 at the top of the menu will be highlighted. Move the controller left and right to highlight the appropriate menu tab; the menus will change as the tabs are highlighted.

 When the desired menu section is displayed, move the controller up and down to scroll through the menu options. Highlight the option whose settings need to be changed.

 With the menu option to be changed highlighted, move the controller right; the settings will be displayed with the current setting highlighted. To return to the menu options, move the controller left.



Move the controller up and down to highlight the new setting.



Press the controller to select the highlighted setting.

Once a setting has been selected, the cursor will return to the menu options and the new setting will be displayed. Changes can continue to be made. To return to the recording mode, press the menu button.

| | | |
|---|---------------|--|
| 1 | ◀▶ Ctrl func. | Flash mode Exp. comp. Drive mode White balance Off |
| | Auto reset | On Off |
| | Date imprint | YYYY/MM/DD MM/DD/hr:min Off |

| | | |
|---|---------------|------------------------|
| 2 | Digital zoom | On Off |
| | File # memory | On Off |
| | Folder name | Std. form Date form |

Refer to the following sections for details on the menu options and their settings.

SETUP

Pressing the controller with the setup tab highlighted opens the setup menu (p. 78).

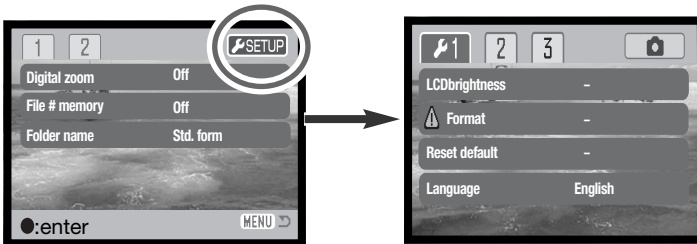

CONTROLLER CUSTOMIZATION

The white balance, drive mode, exposure compensation, or flash mode can be set with the controller. The function assigned to the controller is selected in section 1 of the advanced recording menu (p. 52). Initially, no function is assigned. The white balance, exposure compensation, and off options affect the movie recording mode.

Select the control func. option in section 1 of the advanced recording menu. Select the function to be assigned with the controller (1). Press the controller to set the function (2).

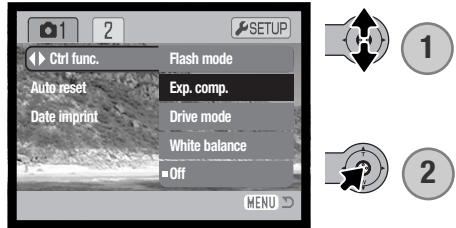

The selected function can be changed by moving the controller left or right in the recording mode. Changes are set automatically after five seconds or when another camera button is pressed.



Refer to the appropriate sections for information on the drive mode (p. 40), white balance (p. 44), flash mode (P. 38), and exposure compensation (p. 47).

AUTO RESET

When auto reset is active, the following functions are reset when the camera is turned off. This function can be turned off in section 1 of the advanced recording menu (p. 52).

Flash mode (p. 38) – Auto

Drive mode (p. 40) – Single-frame advance

White balance (p. 44) – Auto

Exposure compensation (p. 47) – 0.0 Ev

LCD monitor display (p. 30) – Full

Colour mode (p. 48) – Colour

Portrait (p. 49) – Off

The flash mode is reset to autoflash or autoflash with red-eye reduction whichever of the two modes was last used. Exposure mode, white balance, LCD monitor display, and colour mode are also reset in the movie recording mode.

DATE IMPRINTING

The date and time of recording can be printed directly on the image. The imprinting function must be activated before the image is taken. Once activated, the date will continue to be imprinted until the function is reset; a yellow bar is displayed behind the frame counter on the monitor to indicate the imprinting function is active.

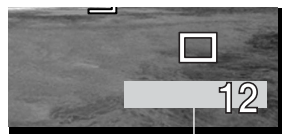

Date-imprinting indicator

Date imprinting is activated with section 1 of the advanced recording menu (p. 52). Date imprinting has two menu options. The YYYY/MM/DD option prints the date. The MM/DD/hr:min option prints the month, day, and time of recording.



The date and time are imprinted in the lower right corner of the image when viewed horizontally. It is printed directly on the photograph writing over the image information. The date can be imprinted in three formats: year / month / day, month / day / year, and day / month / year. The date and date format are set in section 3 of the setup menu (p. 86).

Camera Notes

Every time a still image is recorded, it is stored with an Exif tag that contains the date and time of recording as well as shooting information. This information can be viewed with the camera in the playback mode, or on a computer with the DiIMAGE Viewer software.

DIGITAL ZOOM

The digital zoom is activated in section 2 of the advanced recording menu (p. 52). The digital zoom increases the magnification of the greatest telephoto setting of the optical zoom by up to 4X in multiple steps. When the digital zoom is activated, the zoom scale includes both the optical and digital zoom range. Although the images recorded with the digital zoom are interpolated to the set image-quality size, the quality of the images may not be equal to images taken without the digital zoom; the greater the power of the digital zoom the lower the image quality.

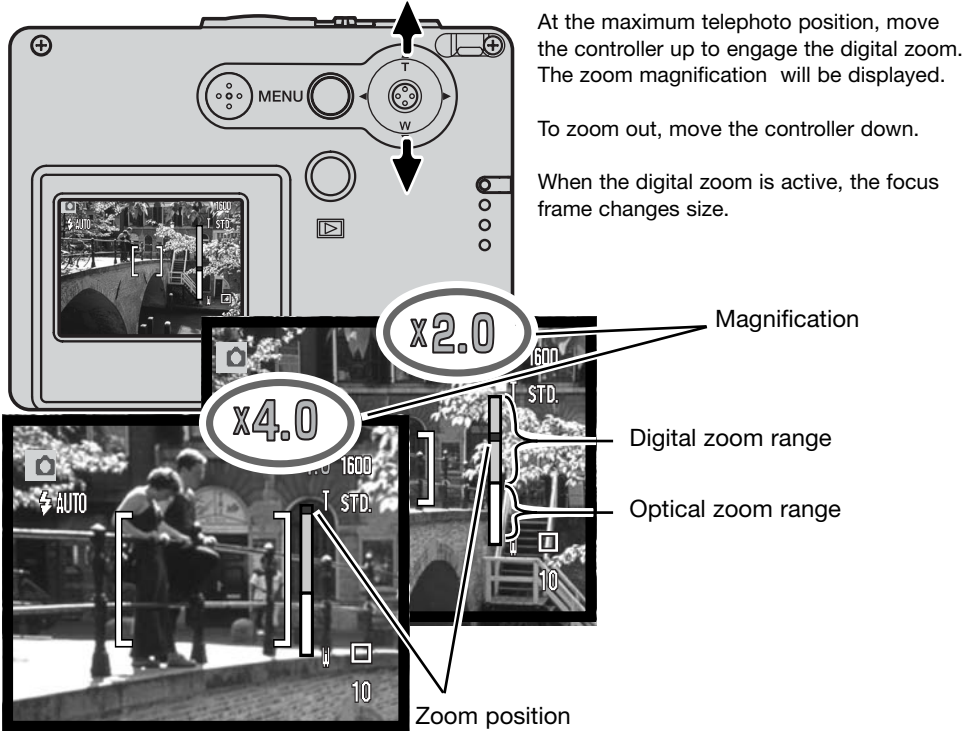

FILE NUMBER (#) MEMORY

If file number memory is selected, when a new folder is created, the first file stored in the folder will have a number one greater than the last file saved. If the file number memory is disabled, the image file number will be 0001. File number memory is activated in section 2 of the advanced recording menu (p. 52).

If file number memory is active and the memory card is changed, the first file saved to the new card will have a number one greater than the last file saved on the previous card if the new card does not contain an image with a greater file number. If it does, the file number of the new image will be one greater than the greatest on the card.

FOLDER NAME

All recorded images are stored in folders on the memory card. Folder names come in two formats, standard and date. Folder name format is selected in section 2 of the advanced recording menu (p. 52).

Standard folders have an eight character name. The initial folder is named 100KM005. The first three digits are the folder's serial number, which will increase by one each time a new folder is created. The next two letters refer to Konica Minolta, and the last three numbers indicate the camera used; 005 indicates a DiMAGE X21.

A date folder name also starts with the three digit serial number and is followed by one register for the year, two register for the month, and two registers for the day: 101YMMDD. The folder 10140315 was created in 2004 on March 15th.

With the date folder format selected, when an image is recorded a new folder with the day's date will be created. All images recorded that day will be placed in that folder. Images recorded on a different day will be placed in a new folder with the corresponding date. If the file number memory function is off, when a new folder is created, the serial number in the image-file name is reset to 0001. If file number memory function is on, the serial number in the image-file will be one greater than the last image saved. For more information on folder organization and file names, see page 94.



100KM005
(Standard)



10140315
(Date)

INSTANT PLAYBACK

Still images can be previewed immediately after they have been captured. Simply continue to hold down the shutter-release button after taking a picture to display the image on the monitor. Release the shutter button to end the playback.

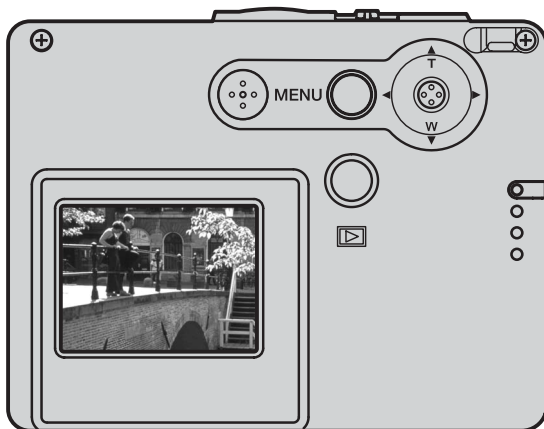
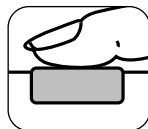

MOVIE RECORDING

This camera can record digital video without audio. Total recording time varies with the image size and the memory card capacity, see the navigating the main movie recording menu section on page 61. In movie recording, some functions can be used, some are fixed, and some are disabled, see the notes section on page 62.



Slide the recording mode switch to the movie recording position.

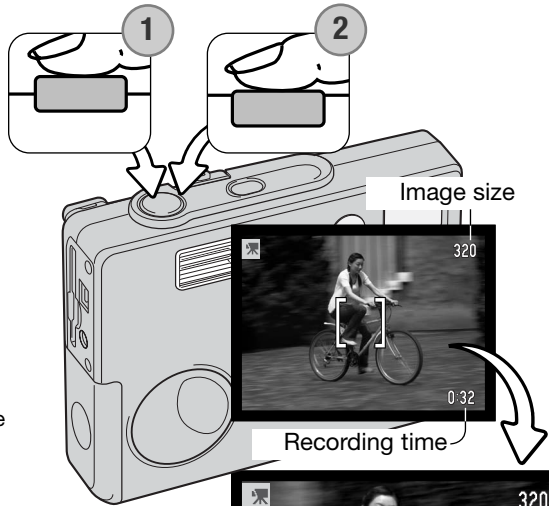

Before recording, the frame counter shows the maximum time in seconds that can be recorded on the next movie clip.

Place the subject in the focus frames and press the shutter-release button partway down to lock focus (1). Press the shutter-release button all the way down and release to begin recording (2).

The camera will continue to record until the recording time is used or the shutter-release button is pressed again.

During recording, focus is locked and the optical zoom is disabled. However, a 4X digital zoom can be adjusted by moving the controller up and down.



Remaining time
Recording indicator

NAVIGATING THE MAIN MOVIE RECORDING MENU

When the menu button is pressed, the main movie menu appears on the LCD monitor. The following four options are available.

1. Image size (320X240 / 160X120)
2. Exposure compensation
3. White balance
4. Colour mode

Selecting the setup icon located in the center of the main menu opens the setup menu.

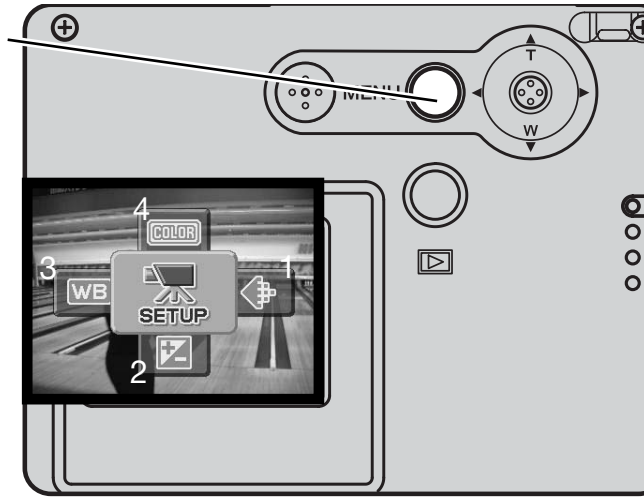

Image size has two settings, 320X240 and 160X120. Image size not only affects the resolution of the movie image, but also changes the maximum length of the movie clip. Recording time is only limited by the capacity of the memory card. A 8 MB memory card can contain approximately 21 seconds of digital video recorded at 320 X 240 or 86 seconds at 160 X 120.

For more on white balance (p. 44), colour mode (p. 48), and exposure compensation (p. 47), see the respective recording-mode sections. Except for image size, any changes made will also affect the recording mode.

To activate the movie-mode main menu, press the menu button.



Move the controller in the direction to highlight the appropriate menu option.



Press the controller to display the option settings.



Move the controller up or down to select the appropriate setting.



Press the controller to apply the setting.

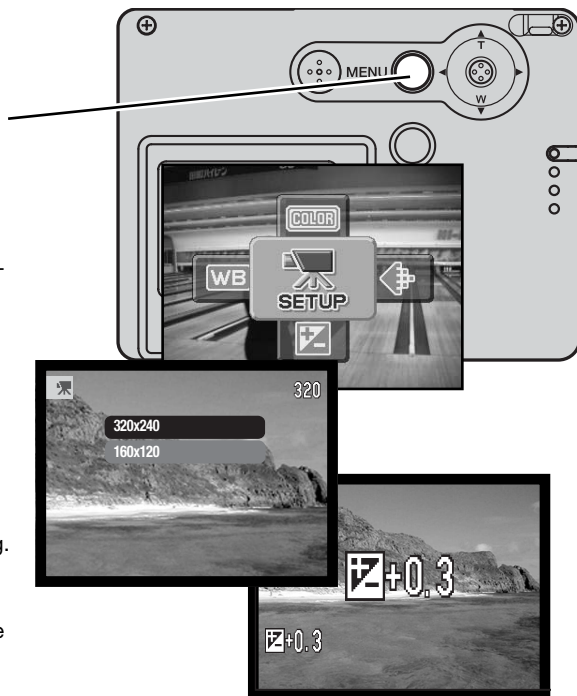

NOTES ON MOVIE RECORDING

In movie recording, some functions can be used, some are fixed, and some are disabled. Exposure, image size, white balance, and the colour mode can be changed with the movie menu; the soft-focus colour mode is not available. The optical and digital zoom are active. Pressing and holding the controller switches between the full display and the live image only. The flash is disabled. Movies cannot be recorded when the red low-battery warning is displayed.

The writing speed of the memory card in use may prematurely end the recording of a movie clip.

PLAYBACK - ADVANCED OPERATION

The basic functions in this mode are described in the basic playback section on pages 32 through 35. This section covers how to playback movie clips as well as the advanced functions on the playback menu.

PLAYING BACK MOVIES

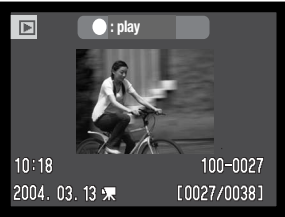

Movie file



Move the controller left and right to display the movie.

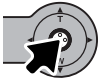

Press the controller to play back the displayed clip.



Press the controller to pause the movie; press the controller again to resume the playback.

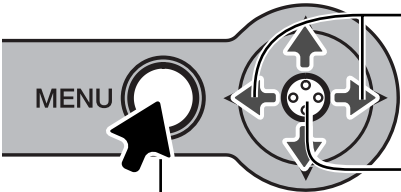

During playback, moving the controller left and right rewinds and fast forwards the recording.

Press and hold the controller to view the movie with or without the guidance bar.

To cancel the playback, press the menu button.

NAVIGATING THE MAIN PLAYBACK MENU

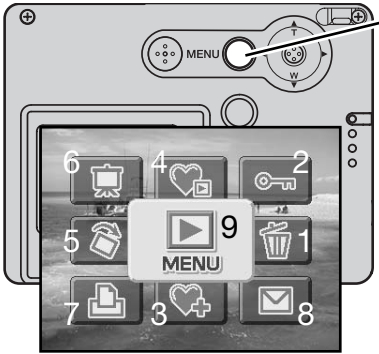

With playback-mode activated, pressing the menu button displays the main playback menu. The following nine options are available:

1. **Delete** - to delete the displayed image (p. 68).
2. **Lock** - to lock the displayed image (p. 69).
3. **Add favorites** - to add a Favorite image to the camera memory (p. 70).
4. **View favorites** - to view Favorite images (p. 71).
5. **Rotate** - to rotate the displayed image (p. 72).
6. **Slide show** - to play back images automatically (p. 73).
7. **DPOF set** - to create a DPOF file for the displayed image (p. 74).
8. **E-mail Copy** - to copy and resize the displayed image for transmission by e-mail (p. 77).
9. **Menu** - to access the advanced playback functions (p. 65).



To activate the main playback menu, press the menu button.



Move the controller in the direction to highlight the desired menu option. If the menu icon is struck through, the menu function is disabled.

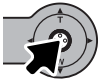

Press the controller to select the option.



Refer to the following sections for details on the menu options and their settings.

NAVIGATING THE ADVANCED PLAYBACK MENU

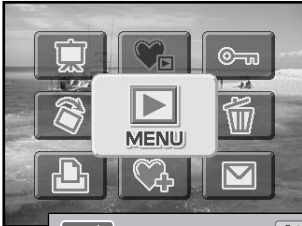

Selecting the menu icon on the main menu displays the advanced playback menu to access the advanced playback functions. See the next page for menu options.

Navigating the menu is simple. Push the controller in the direction to move the cursor and change settings on the menu. Pressing the center button of the controller selects menu options and sets adjustments.

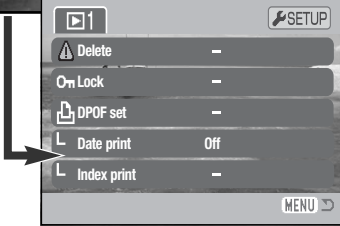

 To activate the main menu of the playback mode, press the menu button.

 With the menu icon selected, press the controller to open the menu.



Move the controller up and down to scroll through the menu options. Highlight the option whose settings need to be changed.



With the menu option to be changed highlighted, move the controller right; the settings will be displayed with the current setting highlighted. To return to the menu options, move the controller left.



Move the controller up and down to highlight the new setting.



Press the controller to select the highlighted setting.

Once a setting has been selected, the cursor will return to the menu options and the new setting will be displayed. Changes can continue to be made. To return to the playback-mode, press the menu button.

Menu Options in the Playback Mode

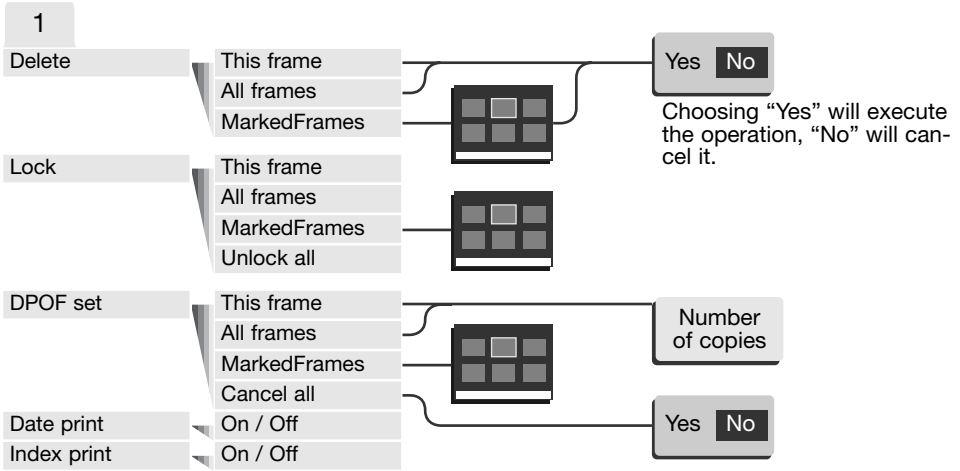

Refer to the following sections for details on the menu options and their settings.



FRAME-SELECTION SCREEN

When a marked-frames setting is chosen on the menu, the frame-selection screen will appear. This screen allows multiple image files to be chosen.



Pushing the controller left and right moves the yellow border to select the image.



Moving the controller up selects the frame; when selected, an indicator will appear next to the image. Moving the controller down will deselect the image removing the indicator.



The menu button cancels the screen and any operation made.



The garbage-can indicator shows the image is selected for deletion.



The key indicator shows the image is locked or selected to be locked.



The printer indicator shows the image is selected for DPOF printing. The number of copies is shown on the right.



Press the controller to complete the operation.

Indicators may be displayed on the right of each index image to indicate movie and E-mail Copy files.



Movie file



E-mail copy file

DELETING IMAGE FILES



Deleting permanently erases the file. Once deleted, a file cannot be recovered. Care should be taken when deleting images.

Before a file is deleted, a confirmation screen will appear; choosing “Yes” will execute the operation, “No” will cancel the operation.

 Delete this frame?

Deleting a single image



A single image displayed or highlighted on the monitor can be deleted with the main playback menu (p. 64).

Deleting multiple or all images

Single, multiple, or all files on the memory card can be deleted in the advanced playback menu (p. 65). The delete option of the advanced playback menu has three settings:

| | |
|----------------------|---|
| This frame | The file displayed or highlighted in playback mode will be deleted. |
| All frames | All unlocked files will be deleted. |
| Marked frames | To delete multiple files. When this setting is chosen, the frame-selection screen will be displayed. Move the controller left and right to highlight the first file to be deleted. Moving the controller up will mark the thumbnail with the delete indicator. To deselect a file for deletion, highlight it with the yellow border and move the controller down; the delete indicator will disappear. Continue until all the files to be deleted are marked. Press the controller to continue (the confirmation screen will appear), or press the menu button to cancel the operation. |

The delete function will only erase unlocked files. Locked files must be unlocked before they can be deleted.

LOCKING IMAGE FILES

Images can be locked to prevent them from being deleted with the advanced playback menu. However, the formatting function (p. 82) will erase all files on a memory card whether locked or not. Important images should be locked.

Locking a single image



A single image displayed or highlighted on the monitor can be locked with the main playback menu (p. 64). Locked file can be unlocked by the same operation.

Locking multiple or all images

Single, multiple, or all files on the memory card can be locked in the advanced playback menu (p. 65). The lock option has four settings:

| | |
|----------------------|---|
| This frame | The file displayed or highlighted in playback mode will be locked. |
| All frames | All files on the memory card will be locked. |
| Marked frames | To lock or unlock multiple files. When this setting is chosen, the frame-selection screen will be displayed. Move the controller left and right to highlight the file to be locked. Moving the controller up will mark the file with the lock indicator. To unlock a file, highlight it with the yellow border and move the controller down; the lock indicator will disappear. Continue until all the files to be locked are marked. Press the controller to lock the marked thumbnails, or press the menu button to cancel the operation. |
| Unlock all | All files on the memory card will be unlocked. |

ADDING TO FAVORITES



A maximum of 10 still images can be added to Favorites. These images are 640 X 480 standard quality copies of the original image and are stored in the camera, not on the memory card. Favorites allow pictures from different memory card to be collected. The Favorites are protected from being viewed when the camera is simply turned on, see page 71.

A single still image displayed or highlighted in the playback mode can be copied to favorites by selecting the add-to-favorite function in the main playback menu (p. 64). Movie clips or E-mail Copies cannot be added to Favorites.



When the add-to-favorite icon is selected, the copy routine will begin and a screen will appear to indicate the image has been copied; press the controller to return to the menu. When the number of images copied exceeds 10, "unable to copy" message appears.

VIEWING FAVORITES

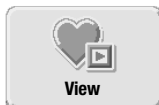

Favorites cannot be viewed when the camera is simply turned on. This is to protect your personal collection of images from the view of strangers.

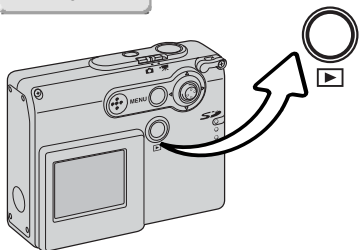

With the camera off or in a recording mode, press and hold the playback button for a few seconds. Playback images are displayed. Favorites are viewed from the main menu.

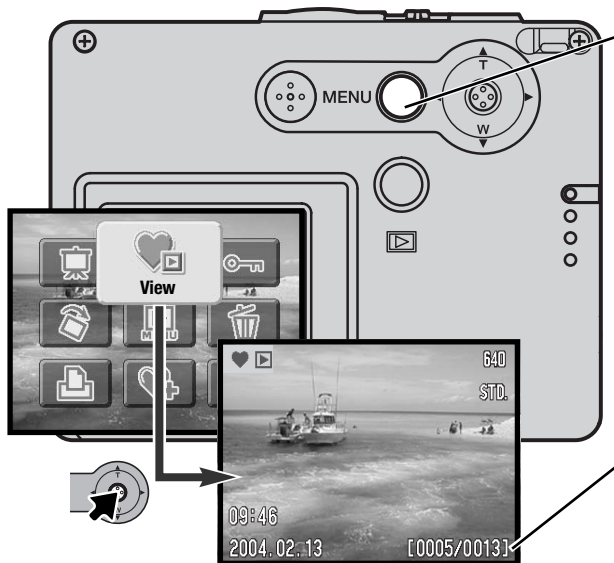

Press the menu button to activate the main menu. Select the view-Favorites icon. The last Favorite added is displayed as well as the Favorites-mode indicator. If no Favorites are saved the no-image message appears.

Favorites copy number / total number of Favorites copies

While viewing Favorites, many menu functions are available to delete, lock, and display images. However, certain functions are not available such as E-mail Copy, add-to-Favorites, and DPOF setup. Favorites cannot be printed or saved to a computer.

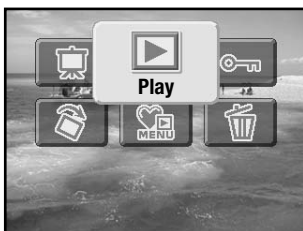

To go back to normal playback, select the play icon on the main menu. Turning the camera off also cancels the favorite mode.

Favorites copies can be deleted only in the view-Favorites mode. Neither deleting (p. 68) all the frames in normal playback nor formatting the memory card erases Favorites.

ROTATE



Rotate display orients a single vertical image displayed or highlighted in the playback mode so that it can be viewed without having to turn the camera sideways. The rotate function is selected in the main playback menu (p. 64).



Move the controller up to turn the image clockwise and down to turn it counterclockwise. Press the control button to set the image orientation.

SLIDE SHOW



On the main menu (p. 64), selecting the slide show icon and pressing the controller starts the slide show. This function automatically displays all still images on the memory card in order. Movie clips are not displayed.

To start a Favorites slide show, select the slide show icon from the main menu in the view-Favorites mode (p. 71).



Press the controller to pause and restart the slide show presentation.



To cancel the presentation, press the menu button.



Moving the controller left and right advances to the next image or returns to the previous one.

Camera Notes



The presentation can be viewed without image information. Before opening the playback menu, press the controller for a few seconds to turn off the information display.

ABOUT DPOF

This camera is supported by DPOF™ version 1.1. The DPOF (Digital Print Order Format) allows direct printing of still images from digital cameras. After the DPOF file is created, the memory card is simply taken to a photofinishing service or inserted into the memory-card slot of DPOF compatible printers. When a DPOF file is created, a misc. folder is automatically created on the memory card to store it (p. 94).

CREATING A DPOF PRINT ORDER

The DPOF-set menu option is used to create an order for standard prints from still images on the memory card.

Creating a print order for a single image



DPOF print order for the image displayed or highlighted on the monitor can be created by selecting the DPOF icon on the main playback menu (p. 64).



A screen will appear requesting the number of copies of the image. Moving the controller up will increase the number of copies, moving the controller down will decrease the number. A maximum of nine copies can be ordered.



Press the controller to create the DPOF file, or press the menu button to cancel the operation.

To delete the DPOF file, display the image and select the DPOF icon on the main playback menu. Move the controller down until the number of copies reaches zero. Press the controller to complete the operation.

Creating print order for multiple images

DPOF print order for single, multiple, or all files on the memory card can be created in the advanced playback menu (p. 65). The print menu option has four settings:

| | |
|----------------------|--|
| This frame | To create a DPOF file for the displayed or highlighted image. |
| All frames | To create a DPOF file for all images on the memory card. |
| Marked frames | To chose a group of images to be printed or when the number of copies of each image varies. When selected, the frame selection screen will appear. Move the controller left and right to highlight an image to be printed. Moving the controller up will mark the image with the print indicator. The number next to the indicator shows the number of copies that will be printed. Moving the controller up will increase the number of copies, moving the controller down will decrease the number. A maximum of nine copies can be ordered. To deselect an image for printing, move the controller down until the number of copies reaches zero and the print indicator disappears. Continue until all the images to be printed are marked. Press the controller to create the DPOF file, or press the menu button to cancel the operation. |
| Cancel all | To delete the DPOF file. |

When the this-frame or all-frames setting is chosen, a screen will appear requesting the number of copies of each image; a maximum of nine copies can be ordered. Move the controller up and down to set the required number of copies. If the all-frames setting was used to create a print order, any additional images recorded afterwards will not be included in the order.

DPOF files created with another camera will be canceled. After the pictures have been printed, the DPOF file will still remain on the memory card and must be canceled manually.

ORDERING AN INDEX PRINT

To create an index print of all the images on the card, select “On.” To cancel an index print, simply change the setting to “Off.”

If an index-print order is created, any additional images saved afterwards on the card will not be included in the index print. Select the index-print option just before printing.

The number of images printed per sheet differs between printers. The information printed with the thumbnails can vary.



DATE PRINTING

The date of recording can be printed with each image with DPOF compatible printers. Date printing is initially off. Select the date-print option just before printing. If the date has already been imprinted on the images with the date-imprinting function (p. 56), the date-print function will print an additional date.

To print the date, select “On.” To cancel date printing, select “Off.”

Camera Notes

DPOF files and images can be printed directly from the camera, see page 103.

E-MAIL COPY



E-mail Copy makes a standard 640 X 480 (VGA) or 160 X 120 JPEG copy of a still image displayed or highlighted on the monitor. These copy images can be easily transmitted by e-mail. E-mail Copies are saved to the original card. E-mail Copies can be made in the main menu of the playback mode (p. 64)

When the E-mail Copy function is used, a folder is created for the files (p. 94); copy folder name ends in EM. Copies of locked images are unlocked. DPOF information is not copied.

Select the E-mail icon on the main menu.



Select the image size of the copy. Two sizes are available: 640 X 480 (VGA) or 160 X 120. The copy-unsuccessful message will appear if the image could not be copied.

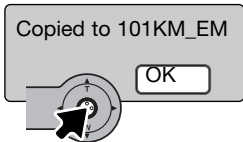

When the image to be converted to an e-mail file is selected, the copy routine will begin and a screen will appear indicating the name of the folder containing the copied images; press the controller to return to the menu. The same folder is used to store e-mail copies until the number of images exceed 9,999.

SETUP MENU - NAVIGATING THE SETUP MENU

Setup menu can be activated from any of the modes: recording, movie, or playback mode.

The diagram illustrates three ways to access the setup menu:

- Recording or Playback Mode:** From the main menu, press the **MENU** button to open the advanced menu. In the top-right corner of the advanced menu, select the **SETUP** tab.
- Movie Mode:** From the main menu, select the **SETUP** icon.

The setup menu options are as follows:

| Item | Value |
|---------------|----------------|
| Digital zoom | Off |
| File # memory | Off |
| Folder name | Std. nor |
| :enter | |
| 1 | DELETE |
| 2 | LOCK |
| 3 | DPOF set |
| 4 | Date print Off |
| 5 | Index print |
| :enter | |
| MENU | |



Navigating the menu is simple. Push the controller in the direction to move the cursor and change settings on the menu. Pressing the controller selects menu options and sets adjustments.



After opening the setup menu, move the controller left and right to highlight the appropriate menu tab; the menus will change as the tabs are highlighted.



When the desired menu section is displayed, move the controller up and down to scroll through the menu options. Highlight the option whose setting needs to be changed.



With the menu option to be changed highlighted, move the controller right; the settings will be displayed with the current setting highlighted. To return to the menu options, move the controller left.



Move the controller up and down to highlight the new setting. If “Enter” is displayed, press the controller to continue.



Press the controller to select the highlighted setting.

Once a setting has been selected, the cursor will return to the menu options and the new setting will be displayed. Changes can continue to be made. To exit the menu and return to the original mode, press the menu button. To return to the menu of the original mode, select the recording or playback tab located in the top-right corner of the setup menu and press the controller.

Menu options in the setup mode

| | |
|---------------|--|
| 1 | |
| LCDbrightness | Enter |
| Format | Enter |
| Reset default | Enter |
| Language | Japanese English Deutsch Français Español Chinese |

| | |
|---------------|---------------|
| 2 | |
| Audio signals | 1 2 Off |
| Focus signal | 1 2 Off |

| | |
|---------------|-----------|
| ShutterSignal | On Off |
|---------------|-----------|

| | |
|-----------|--|
| Power off | 30 min. 10 min. 5 min. 3 min. 1 min. |
|-----------|--|



Choosing "Yes" on the confirmation screens will execute the operation, "No" will cancel it.

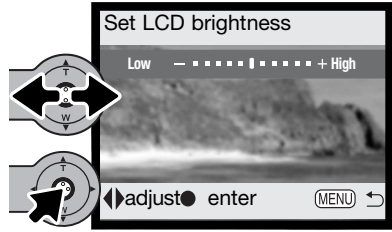

Move the controller left and right to adjust the monitor brightness. Press the controller to set the level.

3

| | |
|---------------|--------------|
| Date/Time set | Enter |
| Date format | YYYY/MM/DD |
| | MM/DD/YYYY |
| | DD/MM/YYYY |
| Transfer mode | Data storage |
| | PictBridge |

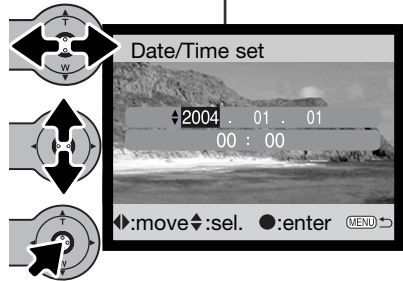

On the date/time setting screen, move the controller left and right to select the year, month, day, hour, or minute. Move the controller up and down to change the value. Press the controller to set the calendar and clock.

Refer to the following sections for descriptions of the menu options and their settings.

LCD MONITOR BRIGHTNESS

The brightness of the LCD monitor can be set in eleven levels. The brightness setting screen is opened from section 1 of the setup menu (p. 78). Move the controller left and right (1) to adjust the brightness, the monitor image will change accordingly. Press the controller (2) to set the brightness level.

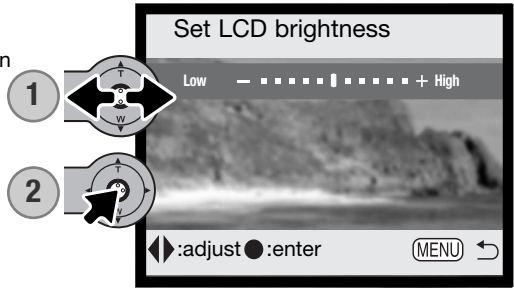

FORMATTING MEMORY CARDS



When a memory card is formatted, all data on the card is erased.

The formatting function is used to erase all data on a memory card. Before formatting a memory card, copy the data to a computer or storage device. Locking images will not protect them from being deleted when the card is formatted. Formatting the memory card does not erase Favorites files since they are stored in the camera memory. Always format the memory card using the camera; never use a computer to format a card.

When the format option is selected and entered in section 1 of the setup menu (p. 78); a confirmation screen will appear. Choosing "Yes" will format the card, choosing "No" will cancel the formatting operation. A screen will appear to indicate the card has been formatted.

If the unable-to-use-card message appears, the inserted card in the camera may need to be formatted. A memory card used in another camera may also have to be formatted before being used.

RESET DEFAULT

This function affects all modes. When selected, a confirmation screen will appear; choosing “Yes” resets the following functions and settings, “No” cancels the operation. Reset default can be set in section 1 of the setup menu (p. 78)

| | | |
|--------------------------|----------------------|-------|
| Digital zoom | Off | p. 57 |
| Drive mode | Single-frame advance | p. 40 |
| Flash mode | Autoflash | p. 38 |
| Image quality (still) | 1600 X 1200 Standard | p. 45 |
| Image size (movie) | 320 X 240 | p. 61 |
| Exposure compensation | 0.0 | p. 47 |
| White balance | Auto | p. 44 |
| Portrait | Off | p. 49 |
| Date imprinting | Off | p. 56 |
| Colour modes | Colour | p. 48 |
| Auto reset | On | p. 55 |
| Controller customization | Off | p. 54 |
| LCD monitor display | Full display | p. 30 |

| | | |
|--------------------------|--------------|-------|
| Special effects | Off | p. 50 |
| Image size (E-mail copy) | 640 X 480 | p. 77 |
| LCD monitor brightness | Normal | p. 82 |
| Auto-power-off period | 3 minutes | p. 85 |
| File number memory | Off | p. 58 |
| Folder name | Standard | p. 58 |
| Audio signals | 1 | p. 84 |
| Focus signal | 1 | p. 85 |
| Shutter signal | On | p. 85 |
| Transfer mode | Data storage | p. 86 |

LANGUAGE

The language used in the menus can be changed. The language is selected in section 1 of the setup menu (p. 78).

AUDIO SIGNALS

Every time a button is pressed, an audio signal will give a positive confirmation of the operation. The audio signals can be turned off in section 2 of the setup menu (p. 78). Two signals are available.

FOCUS SIGNAL

When the focus is confirmed, the focus signal will give a positive confirmation of the operation. The focus signal can be turned off in section 2 of the setup menu (p. 78). Two signals are available.

SHUTTER SIGNAL

When the shutter is released, a shutter signal will give a positive confirmation of the operation. The signal can be turned off in section 2 of the setup menu (p. 78).

AUTO POWER OFF

To conserve battery power, the camera will shut down if an operation is not made within a certain period. To restore power, press the main switch. The length of the auto-power-off period can be changed in section 2 of the setup menu (p. 78): 1, 3, 5, 10, and 30 minutes. The length of the auto-power-off period is fixed at 10 minutes when the camera is connected to a computer.

DATE AND TIME

It is important to accurately set the clock. When a recording is made, the date and time of the recording are saved with the file and are displayed in playback mode or with the DiMAGE Viewer software included on the CD-ROM. See page 81 for how to set the date and time.

DATE FORMAT

The date format that is used in monitor displays and for date imprinting can be changed: YYYY/MM/DD (year, month, day), MM/DD/YYYY (month, day, year), DD/MM/YYYY (day, month, year). Simply select the format and enter it by pressing the controller; the new format will be displayed on the menu. The date format does not affect date folder names (p. 58). The date format is set in section 3 of the setup menu (p. 78).

TRANSFER MODE

The transfer-mode option switches the camera between a data storage device and PictBridge. To transfer files from the camera to a computer or to use the camera with the DiMAGE Viewer software, the data storage option must be selected. The PictBridge option allows the images to be printed with a PictBridge compatible printer. For more on connecting the camera to a computer and the PictBridge function, refer to the data-transfer section of the manual.

DATA-TRANSFER MODE

Read this section carefully before connecting the camera to a computer. Details on using and installing the DiIMAGE Viewer software are found in the supplied software manual. The DiIMAGE manuals do not cover the basic operation of computers or their operating systems; please refer to the manual supplied with your computer.

SYSTEM REQUIREMENTS

For the camera to be connected directly to the computer and used as a mass-storage device, the computer must be equipped with a USB port as a standard interface. The computer and the operating system must be guaranteed by their manufacturers to support USB interface. The following operating systems are compatible with the camera:

| IBM PC / AT Compatible | Macintosh |
|---|--|
| Windows 98, 98SE, Me, 2000 Professional, and XP(Home/Professional). | Mac OS 9.0 ~ 9.2.2 and Mac OS X 10.1.3 - 10.1.5, 10.2.1 - 10.2.8, and 10.3 - 10.3.1. |

Check the Konica Minolta web site for the latest compatibility information:
North America: <http://www.konicaminolta.us/>
Europe: <http://www.konicaminoltasupport.com>

Users with Windows 98 or 98 second edition will need to install the driver software on the included DiIMAGE Viewer CD-ROM (p. 91). No special driver software is required for other Windows or Macintosh operating systems.

Customers who have bought a previous DiIMAGE digital camera and have installed the Windows 98 driver software must repeat the installation procedure. The updated version of the driver software included on the supplied DiIMAGE Viewer CD-ROM is required for the operation of the DiIMAGE X21 with a computer. The new software will have no affect on the performance of older DiIMAGE cameras.

CONNECTING THE CAMERA TO A COMPUTER

Confirm the battery has the sufficient power before connecting the camera to a computer. The use of the AC adapter (sold separately) is recommended over the use of the battery. For users with Windows 98 or 98SE, read the section on page 90 on how to install the necessary USB driver before connecting the camera to a computer.

1. Start up the computer. The computer must be turned on before connecting the camera.
2. Insert the memory card into the camera. To change the memory card while the camera is connected to a computer, see page 98.
3. Slide the USB-port cover open. Insert the small plug of the USB cable into the camera. Make sure the plug is firmly attached.
4. Attach the other end of the USB cable to the computer's USB port. Make sure the plug is firmly attached. The camera should be connected directly to the computer's USB port. Attaching the camera to a USB hub may prevent the camera from operating properly.
5. Turn on the camera to initiate the USB connection. While the camera is connected to a computer, the data-transfer screen will be displayed.

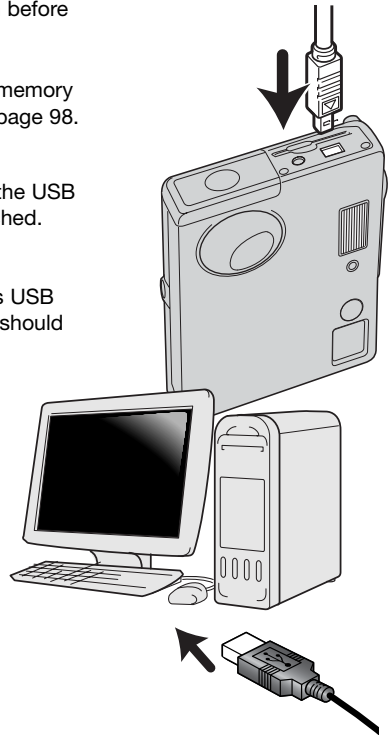
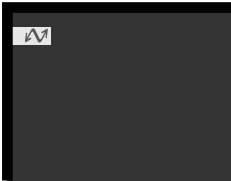



Windows XP

When the camera is properly connected to the computer, a drive icon, or volume, will appear. When using Windows XP or Mac OS X, a window will open requesting instructions on what to do with the image data; follow the directions in the window. If the computer does not recognize the camera, disconnect the camera and restart the computer. Repeat the connection procedure above.



Mac OS X

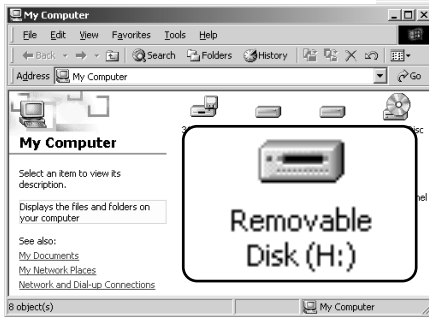

Windows

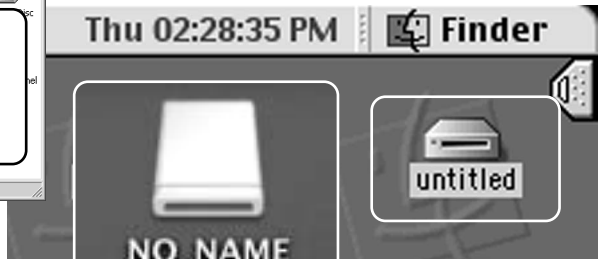

Mac OS X

Mac OS

The volume name varies between memory cards.

CONNECTING TO WINDOWS 98 AND 98SE

The driver needs only to be installed once. If the driver cannot be installed automatically, it can be installed manually with the operating system's add-new-hardware wizard; see the instructions on the following page. During installation, if the operating system requests the Windows 98 CD-ROM, insert it into the CD-ROM drive and follow the accompanying instructions on the screen. No special driver software is required for other Windows operating systems.

Automatic Installation

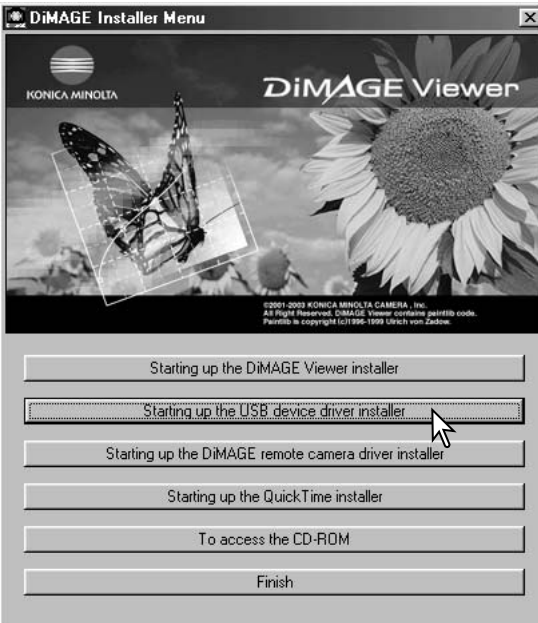

Before connecting the camera to the computer, place the DiMAGE Viewer CD-ROM in the CD-ROM drive. The DiMAGE installer menu should automatically activate. To automatically install the Windows 98 USB driver, click on the starting-up-the-USB-device-driver-installer button. A window will appear to confirm that the driver should be installed; click "OK" to continue.



When the driver has been successfully installed, a window will appear. Click "OK." Restart the computer before connecting the camera (p. 88).

Manual installation

To install the Windows 98 driver manually, follow the instructions in the connecting-the-camera-to-a-computer section on page 88.

When the camera is plugged into the computer, the operating system will detect the new device and the add-new-hardware-wizard window will open. Place the DiIMAGE Viewer CD-ROM in the CD-ROM drive. Click “Next.”



Choose the recommended search for a suitable driver. Click “Next.”



Choose to specify the location of the driver. The browse window can be used to indicate the driver location. The driver should be located in the CD-ROM drive at :\\Win98\\USB. When the location is shown in the window, click “Next.”

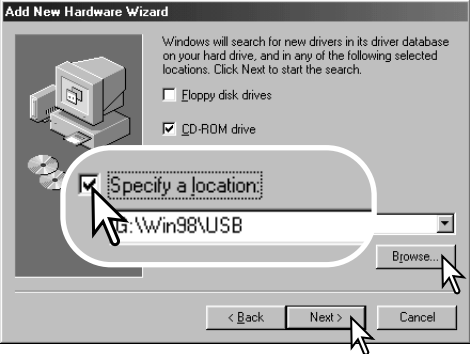

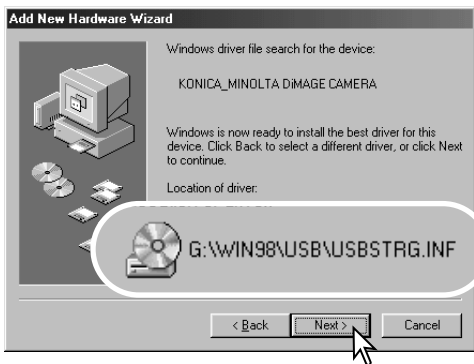

The add new hardware wizard will confirm the location of the driver. One of three drivers may be located: MNLVENUM.inf, USBPDR.inf, or USBSTRG.inf. The letter designating the CD-ROM drive will vary between computers. Click “Next” to install the driver in the system.

The last window will confirm the driver has been installed. Click “Finish” to close the add new hardware wizard. Restart the computer.

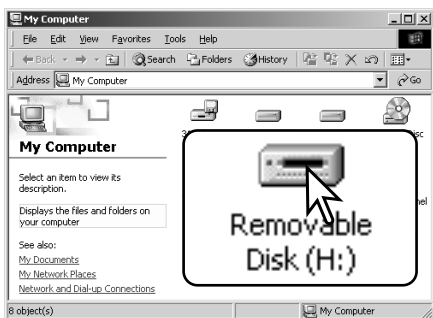

When the my-computer window is opened, a new removable-disk icon will be displayed. Double click on the icon to access the camera’s memory card; see page 94.

QUICKTIME SYSTEM REQUIREMENTS

| | |
|--|--|
| IBM PC / AT Compatible | To install QuickTime, follow the instructions in the installer. Macintosh users can download the latest version of QuickTime free of charge from the Apple Computer web site: http://www.apple.com . |
| Pentium-based or compatible computer | |
| Windows 98, 98SE, Me, 2000 Professional, or XP. | |
| 128MB or more of RAM | |

AUTO POWER OFF - DATA-TRANSFER MODE

If the camera does not receive a read or write command within ten minutes, it will shut down to save power. When the camera shuts down, an unsafe-removal-of-device warning may appear on the computer monitor. Click "OK." Neither the camera or computer will be damaged in this operation. Unplug the USB cable and turn off the camera. Remake the USB connection by reattaching the cable and turning the camera on.

MEMORY CARD FOLDER ORGANIZATION

Once the camera is connected to the computer, image files can be accessed by double clicking on icons. Image folders are located in the DCIM folder. To copy images, simply drag and drop the file icon into a location in the computer.

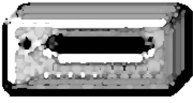

Drive Icon

Files and folders on the memory card can be deleted using the computer. Never format the memory card from the computer; always use the camera to format the card. Only files recorded by the camera should be stored on the memory card.



Dcim



Misc

The misc. folder contains DPOF print files (p. 74).



100KM005



10140315



102KM_EM



PICT0001.JPG
Still image



PICT0002.MOV
Movie clip

Image file names begin with "PICT" followed by a four-digit file number and a jpg or mov extension. The jpg extension indicates a still image, and the mov extension, a movie clip.

E-mail Copy images are placed in a folder ending in "EM." When a new folder is created, the first three digits in the folder name will be one greater than the largest folder number on the card. When the index number in the image file name exceeds 9,999, a new folder will be created with a number one greater than the greatest folder number on the memory card: e.g. from 100KM005 to 101KM005.

The number in the image file name may not correspond to the frame number of the image. As images are deleted in the camera, the frame counter will adjust itself to show the number of images on the card and reassign the frame numbers accordingly. The serial numbers used with image files will not change when an image is deleted. When a new image is recorded, it will be assigned a number one greater than the largest serial number in the folder. File serial numbers can be controlled with the file-number-memory function in section 2 of the advanced recording menu (p. 58).

Camera Notes

Image files contain Exif tag data. This data includes the time and date the image was recorded as well as the camera settings used. This data can be viewed with the camera or the DiMAGE Viewer software. If a camera image is opened in an image-processing application that does not support Exif tags, and then the image is saved overwriting the original data, the Exif tag information is erased. Some Exif compatible applications rewrite the Exif data preventing the DiMAGE Viewer from reading it. When using software other than the DiMAGE Viewer, always make a backup copy of the image files to protect the Exif tag data.

To view images correctly on your computer, the monitor's colour space may need to be adjusted. Refer to your computer manual on how to calibrate the display to the following requirements: sRGB, with a colour temperature of 6500K, and a gamma of 2.2.

DISCONNECTING THE CAMERA FROM A COMPUTER



Never disconnect the camera when the indicator lamp is red - the data or memory card may permanently be damaged.

Windows 98 / 98 Second Edition

Confirm that the indicator lamp is not lit. Turn the camera off, and then disconnect the USB cable.

Windows Me, 2000 Professional, and XP



To disconnect the camera, click once on the unplug-or-eject-hardware icon located on the task bar. A small window will open indicating the device to be stopped.

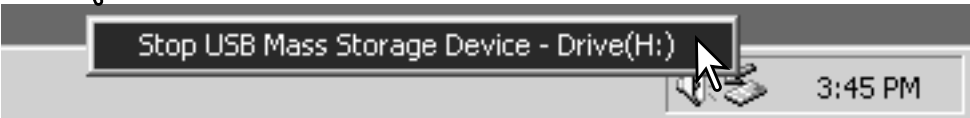

Click on the small window to stop the device. The safe-to-remove-hardware window will open. Close the window, turn the camera off, and then disconnect the USB cable.



When more than one external device are connected to the computer, repeat the procedure above except right click on the unplug-or-eject-hardware icon. This will open the unplug-or-eject-hardware window after clicking on the small window indicating the unplug-or-eject-hardware routine.



The hardware devices to be stopped will be displayed. Highlight the device by clicking on it then click “Stop.”

A confirmation screen will appear to indicate the devices to be stopped. Clicking “OK” will stop the device.

A third and final screen will appear to indicate the camera can be safely disconnected from the computer. Close the window, turn the camera off, and then disconnect the USB cable.

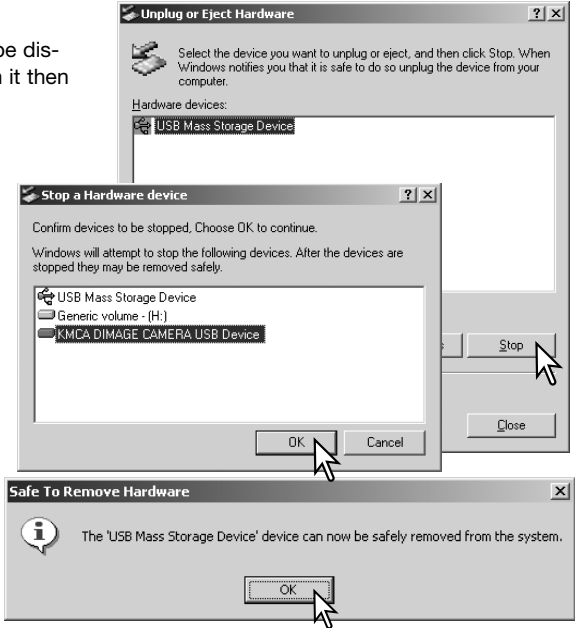

Macintosh

Confirm that the indicator lamp is not lit and then drag the mass-storage device icon and drop it into the trash. Turn the camera off, and then disconnect the USB cable.



CHANGING THE MEMORY CARD - DATA-TRANSFER MODE



Never remove the card when the indicator lamp is red and blinking - the data or memory card may permanently be damaged.

Windows 98 and 98 Second Edition

1. Turn off the camera.
2. Change the memory card.
3. Turn on the camera to remake the USB connection.

Windows ME, 2000 Professional, and XP

1. Stop the USB connection using the unplug-or-eject-hardware routine (p. 96).
2. Turn off the camera.
3. Change the memory card.
4. Turn on the camera to remake the USB connection.

Macintosh

1. Stop the USB connection by dragging the drive icon into the trash (p. 97).
2. Turn off the camera.
3. Change the memory card.
4. Turn on the camera to remake the USB connection.

USING PICTBRIDGE

PictBridge allows still images on the memory card to be printed directly from a PictBridge-compatible printer. The maximum number of images that can be specified for printing is 50. To use PictBridge, the transfer-mode option in section 3 of the setup menu must be set to PictBridge.

Before each print run, check the printer settings; refer to the printer manual. If the date has already been imprinted on the images with the date-imprinting (p.56) function, or the DPOF date printing (p. 76) is on, the PictBridge data-print function prints an additional date. A fully charged battery should be used when the camera is connected to the printer. The use of the AC adapter (sold separately) is recommended over the use of the battery.

Connect the camera to the printer using the camera's USB cable. The larger plug on the cable is connected to the printer. Slide open the USB-port cover and insert the smaller plug of the cable into the camera. Turn the camera on. The PictBridge screen will be displayed. For other printing options, see the menu navigation section.

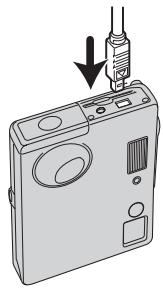

Number of prints in the print run.

Number of copies of the displayed image.

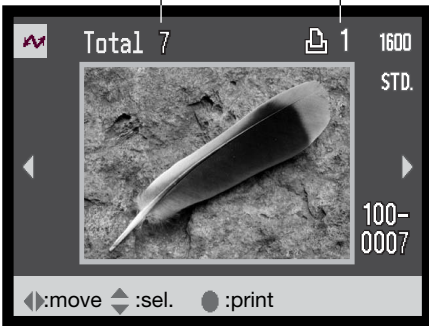

Move the controller left and right to display the image to be printed.



Move the controller up to select the number of copies to be printed. A maximum of twenty copies can be selected. To deselect an image for printing, move the controller down until the number of copies reaches zero.



Repeat the previous steps until all the images to be printed are selected. Press the controller to continue. If the number of images exceeds 50, "Limit:50 images. Reselect images to print." message appears. Reduce the number of images.

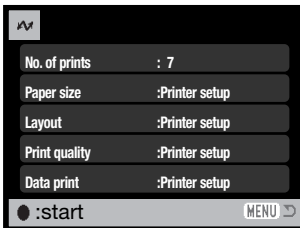

The number of prints in the print run are displayed as well as the print parameters selected with the menu. See the menu navigation section in the page 100 for more information. Press the controller to begin printing, or press the menu button to return to the PictBridge screen.

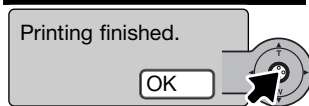

Once printing begins, the operation can be canceled by pressing the controller. The printing finished message indicates the end of the operation; turn the camera off to end the routine.

NOTES ON PRINTING ERRORS

If a minor problem occurs during printing, such as the paper runs out, follow the procedure recommended for the printer; no action is required for the camera. If a major printer error occurs, press the controller to end the routine. Refer to the printer manual for the correct procedure for the printer problem. Check the printer settings before starting again and deselect the images that were printed.

NAVIGATING THE PICTBRIDGE MENU

Navigating the menu is simple. Pressing the menu button turns the menu on and off. Push the controller in the direction to move the cursor and change settings on the menu. Pressing the controller selects menu options and sets adjustments.



Move the controller left and right to highlight the appropriate menu tab; the menus will change as the tabs are highlighted.



When the desired menu section is displayed, move the controller up and down to scroll through the menu options. Highlight the option whose settings need to be changed.



With the menu option to be changed highlighted, move the controller right; the settings are displayed with the current setting highlighted. If “Start” is displayed, press the center of the controller to continue.



Move the controller up and down to highlight the new setting.



Press the controller to select the highlighted setting.

Once a setting has been selected, the cursor will return to the menu options and the new setting will be displayed. To return to the PictBridge screen, press the menu button.

The options that can be changed vary with the printer.

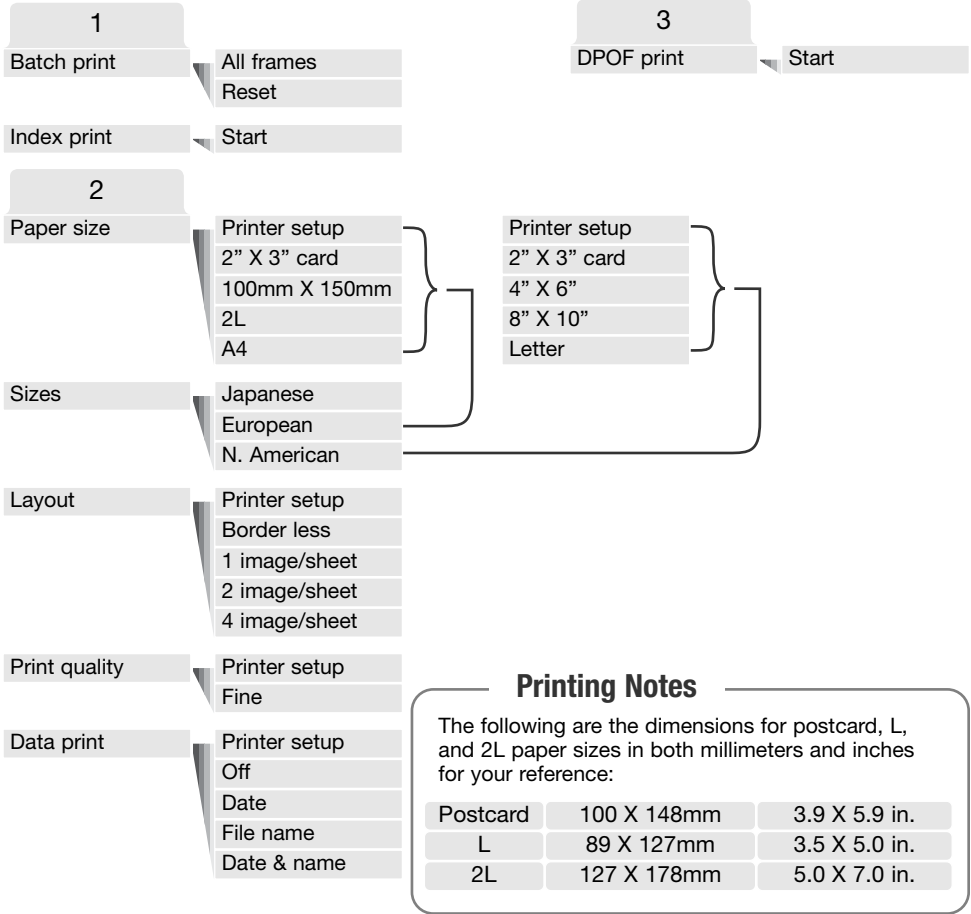

Batch print

Batch print in section 1 of the menu selects all still images on the memory card for printing. Batch print cannot be made if the number of still images on the card exceeds 50. Use the PictBridge screen (p. 99). When the all-frames option is selected, a screen opens so the number of copies of each image can be specified. Up to twenty copies can be printed. The reset option cancels all changes made to the print selection screen.

Index print

An index print of all still images on the memory card can be made. The quality and size of the print can be specified with the camera menu. The number of images per page varies with the printer. The print-setup confirmation screen is displayed before the print routine starts. Index print can be selected in section 1 of the menu.

Paper size

The paper size of the print can be specified in section 2 of the menu. The printer-setup option uses the size set with the printer. The sizes option should be set first, see below.

Sizes

To set paper sizes depending on region. This changes the paper-size option to common sizes used in particular areas. The sizes option is in section 2 of the menu.

Layout

The layout of the print can be set in section 2 of the menu. The printer-setup option uses the layout parameters of the printer. Borderless printing can be specified with the camera as well as the number of images per page.

Print quality

The print quality can be set in section 2 of the menu. The printer-setup option uses the quality set with the printer. The fine quality can be specified with the camera.

Data print

Data printed with the image can be specified in section 2 of the menu. The printer-setup option uses the options set with the printer. The date of capture and the file name can be selected for printing. Data printing can also be disabled with the menu.

PRINTING DPOF FILES

The DPOF-print option in section 3 allows still images and an index print selected with the DPOF printing options in the playback menu to be printed from a PictBridge compatible printer. There is no limit to the number of images that can be printed. See page 74 on how to create a DPOF file.

Before each print run, check the printer settings; refer to the printer manual. A fully charged battery should be used when the camera is connected to the printer. The use of the AC adapter (sold separately) is recommended over the use of the battery.

Connect the camera to the printer using the camera's USB cable. The larger plug on the cable is connected to the printer. Slide open the USB-port cover and insert the smaller plug of the cable into the camera (1).

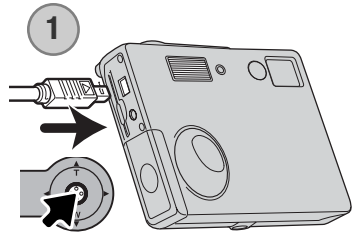

Turn the camera on. Open the PictBridge menu (p. 100). Highlight "Start" in the DPOF-print option in section 3 of the menu. Press the controller to continue.

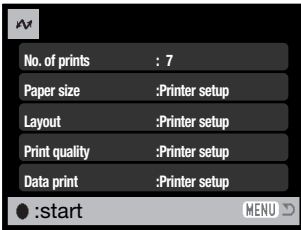

The number of prints in the print run are displayed as well as the print parameters selected with the menu. Index prints are counted as one. Press the controller to begin printing, or press the menu button to return to the PictBridge screen.

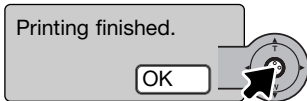

Once printing begins, the operation can be canceled by pressing the controller. The printing finished message will indicate the end of the operation; turn the camera off to end the routine.

APPENDIX

TROUBLESHOOTING

The section covers minor problems with basic camera operation. For major problems or damage, or if a problem continues to reoccur frequently, contact a Konica Minolta service facility.

| Problem | Symptom | Cause | Solution |
|---------------------------|---|--|--|
| The camera will not work. | Nothing displayed on the monitor. | The battery is dead. | Replace battery (p. 14). |
| | | The auto-power-off function has turned the camera off. | Press the main switch to restore power. The length of the auto-power-off period can be changed in section 2 of the setup menu. |
| | | The AC adapter is not connected properly. | Check that the adapter is connected to the camera and a live electrical outlet (p. 16). |
| Shutter will not release. | "0000" is displayed on the frame counter. | Memory card is full and unable to store an image at the image-quality setting on the camera. | Insert a new memory card (p. 18), delete some images (p. 68), or change the image-quality setting (p. 45). |
| | No-card warning appears on the monitors. | No memory card in the camera. | Insert a memory card (p. 18). The camera can record and playback a single still image without a memory card installed in the camera. However, the image cannot be saved. |

| Problem | Symptom | Cause | Solution |
|---|--|---|--|
| Shutter will not release. | Card-locked warning appears on the monitor. | Memory card is locked. | Unlock the memory card using the write-protect switch (p. 19). |
| Pictures are not sharp. | Focus signal is red. | Subject is too close. | Make sure the subject is within the autofocus range (p. 26). |
| | | A special situation is preventing the autofocus system from focusing (p. 27). | Use the focus-lock function to focus on an object at the same distance as the subject (p. 26). |
| | Pictures are taken indoors or in low-light situations without flash. | Slow shutter speeds result in blurred images when the camera is hand-held. | Use a tripod or flash (p. 38). |
| While using flash, the pictures are too dark. | The subject is beyond the flash range (p. 29). | | Move closer to the subject. |

If the camera does not function normally, turn it off, remove and reinsert the battery, or unplug and reconnect the AC adapter. Always turn the camera off using the main switch otherwise the memory card may be damaged and camera settings reset.

REMOVING THE DRIVER SOFTWARE - WINDOWS

1. Insert a memory card in the camera and connect it to the computer with the USB cable. Other devices must not be connected to the computer during this procedure.

2. Right click on the My-computer icon. Select “properties” from the drop-down menu.

Windows XP: from the start menu go to the control panel. Click on the performance and maintenance category. Click “System” to open the system properties window.

3. Windows 2000 and XP: select the hardware tab in the properties window and click the device-manager button.

Windows 98 and Me: click the device-manager tab in the properties window.

4. The driver file will be located in the universal-serial-bus-controller or other-devices location of the device manager. Click on the locations to display the files. The driver should be indicated with the camera name. Under certain conditions, the driver name may not contain the camera name. However, the driver will be indicated by either a question mark or exclamation point.

5. Click on the driver to select it.

6. Windows 2000 and XP: click on the action button to display the drop-down menu. Select “uninstall.” A confirmation screen will appear. Clicking “Yes” will remove the driver from the system.

Windows 98 and Me: click the remove button. A confirmation screen will appear. Clicking “Yes” will remove the driver from the system.

7. Disconnect the USB cable and turn off the camera. Restart the computer.

CARE AND STORAGE

Read this section in its entirety to get the best results from your camera. With proper care, your camera will provide years of service.

Camera care

- Do not subject the camera to shock or impact.
- Turn off the camera when transporting.
- This camera is neither waterproof nor splashproof. Inserting or removing batteries or the memory card, or operating the camera with wet hands may damage the camera.
- When at the beach or near water, take care not to expose the camera to water or sand. Water, sand, dust, or salt can damage the camera.
- Do not leave the camera under direct sunlight. Do not point the lens directly at the sun; the CCD may be damaged.

Cleaning

- If the camera or the outside of the lens is dirty, gently wipe it with a soft, clean, dry cloth. If the camera or lens comes in contact with sand, gently blow away loose particles. Wiping may scratch the surface.
- To clean the lens surface, first blow away any dust or sand, then gently wipe the lens with a cloth or tissue designed for optics. Use lens-cleaning fluid if necessary.
- Never use organic solvents to clean the camera.
- Never touch the lens surface with your fingers.

Storage

- Store in a cool, dry, well-ventilated area away from dust and chemicals. For long periods of disuse, store the camera in an airtight container with a silica-gel drying agent.
- Remove the batteries and memory card from the camera when not in use for extended periods.
- Do not store the camera in an area with naphthalene or mothballs.
- During long periods of storage, operate the camera occasionally. When taking the camera out of storage, check that the camera is functioning properly before using.

Memory cards

SD Memory Cards and MultiMediaCards are manufactured with precision electronic components. The following may cause data loss or damage:

- Improper use of the card.
- Bending, dropping, or subjecting the card to impact.
- Heat, moisture, and direct sunlight.
- Static electrical discharge or electromagnetic fields near the card.
- Removing the card or interrupting the power supply while the camera or a computer is accessing the card (reading, writing, formatting, etc.).
- Touching the electrical contacts of the card with your fingers or metal objects.
- Using the card beyond its life. Purchasing a new card periodically may be necessary.

Memory cards should not be used to permanently store image data. Always make a copy of camera files on an appropriate storage device or recording media. Konica Minolta has no responsibility for any loss or damage to data. It is recommended that a copy of the card data be made.

Batteries

- Battery performance decreases with temperature. In cold environments, we recommend keeping spare batteries in a warm place, such as the inside of a coat. Batteries can recover their power when they warm up.
- Do not store the battery when it is fully charged.
- When storing the battery for extended periods, recharge it for five minutes every six months. The battery may not be able to be charged if completely exhausted.
- A special built-in, long-life battery supplies power to the clock and memory when the camera is turned off. If the camera resets each time it is turned off, the battery is exhausted. It must be replaced at a Konica Minolta service facility.
- Keep battery contacts clean. Dirty contacts can prevent charging. If the contacts become dirty, wipe them with a cotton swab.

Before important events and journeys

- Check the camera's operation; take test pictures and purchase spare batteries.
- Konica Minolta has no responsibility for any damage or loss incurred by equipment malfunction.

Operating temperatures and conditions

- This camera has been designed for use in temperatures from 0°C to 40°C (32°F to 104°F).
- Never leave the camera exposed to extreme high temperatures, such as in a car parked in the sun, or to extreme humidity.
- When taking the camera from a cold to a warm environment, place it in a sealed plastic bag to prevent condensation from forming. Allow the camera to come to room temperature before removing it from the bag.

LCD monitor care

- The LCD monitor is manufactured using high-precision technology and more than 99.99% of the pixels operate properly. Less than 0.01% of the monitor pixels are displayed as colour or bright points; this is not a monitor defect and does not affect the recorded image.
- Do not apply pressure to the surface of the LCD monitor; it may be permanently damaged.
- In cold temperatures, the LCD monitor may become temporarily dark. When the camera warms up, the display will function normally.
- If fingerprints are on the LCD monitor surface, gently wipe with a soft, clean, dry cloth.

Copyright

- TV program, films, video tapes, photographs, and other materials may be copyrighted. Unauthorized recording or duplication of such material may be contrary to copyright laws. Taking pictures or images of performances, exhibitions, etc., is prohibited without approval and can infringe on copyright. Images protected by copyright can only be used under the provisions within the copyright laws.

Questions and service

- If you have questions about your camera, contact your local camera dealer or write to the Konica Minolta distributor in your area.
- Before shipping your camera for repair, please contact a Konica Minolta service facility.

TECHNICAL SPECIFICATIONS

| | |
|----------------------------------|--|
| Number of effective pixels: | 2.0 million |
| CCD: | 1/3.2-type interline primary-colour CCD with a total of 2.1 million pixels. |
| Camera sensitivity (ISO): | Automatic (between ISO 50 - 200 equivalent) |
| Aspect ratio: | 4:3 |
| Lens construction: | 10 elements in 9 groups. |
| Maximum aperture: | f/2.8 - f/3.7 |
| Focal length: | 4.8 - 14.4 mm (35mm equivalent: 37 - 111 mm) |
| Focusing range: | 0.10 m / 0.3 ft. - infinity (from the front of the camera) |
| Autofocusing system: | Video AF |
| Shutter: | CCD electronic shutter and mechanical shutter |
| Shutter speeds: | 4 - 1/500s |
| Flash recycling time: | 6.5 s (approx.) |
| Monitor LCD: | 3.8 cm (1.5 inch) TFT colour monitor |
| Monitor field of view: | Approximately 100% |
| A/D conversion: | 10 bit |
| Recording media: | SD Memory Cards and MultiMediaCards |
| File formats: | JPEG, motion JPEG (MOV), DCF 1.0, DPOF, and Exif 2.2 compliant. |
| Printing output control: | Exif print, PRINT Image Matching II, PictBridge |
| Menu languages: | Japanese, English, German, French, Spanish, and simplified Chinese |
| Batteries: | Two AA batteries: Ni-MH, alkaline |
| Battery performance (recording): | Approximately 90 frames: based on Konica Minolta's standard test method: alkaline batteries, 1600 X 1200 Standard image quality, no instant playback, flash used with 50% of the frames. Approximately 230 frames: based on Konica Minolta's standard test method: Ni-MH batteries, |

| | |
|---------------------------------|--|
| | 1600 X 1200 Standard image quality, no instant playback, flash used with 50% of the frames. |
| Battery performance (playback): | Approximate continuous playback time: 80 min with alkaline batteries. Based on Konica Minolta's standard test method. Approximate continuous playback time: 170 min with Ni-MH batteries. Based on Konica Minolta's standard test method. |
| External power source: | AC adapter (AC-12U, 12E, or 12GB) |
| Dimensions: | 86 (W) X 67 (H) X 24.5 (D) mm 3.39 (W) x 2.64(H) x 0.96 (D) in. |
| Weight: | 115g / 4.1 oz. (approx.) without battery or memory card |
| Operating temperature: | 0° - 40°C / 32° - 104° |
| Operating humidity: | 5 - 85% (noncondensing) |

Specifications are based on the latest information available at the time of printing and are subject to change without notice.



KONICA MINOLTA

We offer support for our digital products 24 hours per day on
www.konicaminoltasupport.com.

Camera know-how, image composition, digital image editing:
discover more about Minolta's new internet world and visit
www.konicaminoltaphotoworld.com

KONICA MINOLTA CAMERA, INC.

© 2003 Konica Minolta Camera, Inc. under the Berne Convention
and the Universal Copyright Convention.

0- 43325-53262- 7

9222-2730-11 MS-A311/KME-0311

Printed in Germany