

E INSTRUCTION MANUAL

DYNAX

**500si
SUPER**

MAXXUM[®]

500si

**500si
SUPER**

**550si
PANORAMA DATE**

RZ 530si

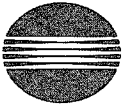

MINOLTA

**BASIC
OPERATION**

**SUBJECT
PROGRAM MODES**

**CREATIVE
EXPOSURE MODES**

FOCUS

FLASH

**ADDITIONAL
FEATURES**

APPENDIX

Thank you for purchasing a Minolta camera and welcome to the wonderful world of autofocus SLR photography. Minolta is pleased to offer you one of the largest accessory lineups to suit your every need. Please take the time to read through this instruction manual for it contains information that is important to the use and care of your camera. Enjoy!

The information contained in this manual is relevant for products introduced before July, 1995. To obtain compatibility information for products introduced after this date, contact the authorized Minolta Service Facility nearest you.

FOR PROPER AND SAFE USE

STANDARD SYMBOLS

Various symbols are used throughout this instruction manual and on the product itself for your proper and safe use of this product, and to prevent personal injury, injury to others, or property damage. An explanation of the symbols follows. Read and understand each caution thoroughly before reading the main text of this instruction manual.

EXAMPLES



The outer triangle is for warning, and the symbol inside illustrates what the reader is being warned about. The example at left means beware of electric shock.



The circle with a diagonal slash denotes prohibition ("don't do"), and the symbol inside illustrates what act is prohibited. The example at left means do not disassemble.

SAFETY CAUTIONS

Read and understand all cautions and warnings thoroughly before use of this product.

 **WARNING**



Do not touch the flashtube during operation - it may become hot when the flash fires.



Do not look directly at the sun through the lens or viewfinder.



Do not subject the camera to direct sunlight. Fire may occur if the sunlight focuses at one point.

 **CAUTION**



Do not fire the flash near the eyes of people or animals, especially babies and young children. Maintain a distance of one meter (three feet) or greater.



- If the camera is dropped or subjected to an impact in which the interior is exposed, immediately remove the batteries and discontinue use.

- Do not disassemble. Contact a Minolta Service Facility when repairs are required.

Electric shock may occur if a high-voltage circuit inside this camera is touched.



 **BATTERY CAUTIONS**



Read and follow all warnings supplied with the batteries. Batteries may explode due to improper use.



- Do not install batteries upside down (+/- reversed).
- Do not use batteries with visible damage.



- Do not subject the batteries to fire, high temperatures, or attempt to recharge, short, or disassemble.

Carefully observe the following warnings when using this product near young children or persons with learning difficulties.

 **WARNING**

Use caution when using this product near young children or persons with learning difficulties. Always keep out of reach when not in use. If caution is not used, the following accidents, and others, may occur:



- Flash fired near the eye.
- Fingers caught in a running motor.
- Strap wound around the neck.

 **CAUTION**

Young children may swallow small objects.



Always keep small accessories, or things that could be swallowed, away from young children.

Contact a doctor immediately if an object is swallowed.

 **BATTERY CAUTION**



Young children may swallow batteries.

Always keep batteries away from young children.

BATTERY CAUTIONS

- When photographing in cold weather, we recommend that you keep the camera and spare batteries inside your coat to keep them warm when you are not shooting. Cold batteries will regain some of their charge when they warm up.
- The low-battery symbol may appear even with a fresh battery depending on the storage conditions. To restore camera power, repeat turning the camera on and off.

OPERATING TEMPERATURE AND CONDITIONS

- This camera is designed for use from -20° to 50°C (-4° to 122°F).
- Never leave your camera where it may be subjected to extreme temperatures such as the glove compartment of a car.
- At colder temperatures, the data panel response time will be slow; at higher temperatures, the display will temporarily darken but will restore when the temperature normalizes.
- Never subject your camera to extreme humidity.
- To prevent condensation from forming, place the camera in a sealed plastic bag when bringing it from the cold exterior to a warm building. Allow it to come to room temperature before removing it from the bag.

HANDLING CARE

- This camera is not waterproof, dust-proof, or sand-proof; take care when using at the beach or near water - costly or irreparable damage to the camera may occur.

TABLE OF CONTENTS

NAMES OF PARTS	8
QUICK OPERATION	12
BASIC OPERATION	
Attaching the Camera Strap	15
Installing the Battery	16
Checking the Battery Power	17
Attaching and Removing the Lens	18
Handling the Camera	19
Loading the Film	20
Taking Pictures in Program Mode	22
Rewinding the Film	25
SUBJECT PROGRAM MODES	
Subject Program Selection	27
Portrait Mode	28
Landscape Mode	29
Close-Up Mode	30
Sports Mode	31
Night Portrait Mode	32
CREATIVE EXPOSURE MODE	
Creative Exposure Selection	35
A Mode	36
Aperture Control	37
S Mode	38
Shutter Speed Control	39
Manual Exposure	40
Exposure Control	41
Bulb	42

FOCUS

Focusing..... 45
Special Focusing Situations 46
Focus Lock..... 47
Manual Focus 48
Autofocus Illuminator 49

FLASH

Using the Built-In Flash..... 51
Built-In Flash Precautions..... 52
Using Flash in P, A, S, M Modes..... 53
Red-Eye Reduction..... 54
Wireless / Remote Off-Camera Flash 55

ADDITIONAL FEATURES

Self-Timer..... 61
Double Exposure Mode 62
Continuous-Drive Mode..... 63
Exposure Compensation 64
Spot Metering..... 65
Setting the Film Speed Manually..... 66
Optional Quartz Data Back Model..... 67

APPENDIX

Program-Reset Button..... 71
Accessory Information 72
Trouble Shooting..... 74
Care and Storage 78
Technical Details..... 80
Quick Reference Guide 83

NAMES OF PARTS

CAMERA BODY

* Do Not Touch!

For more information on specific parts, refer to the page number in parentheses.

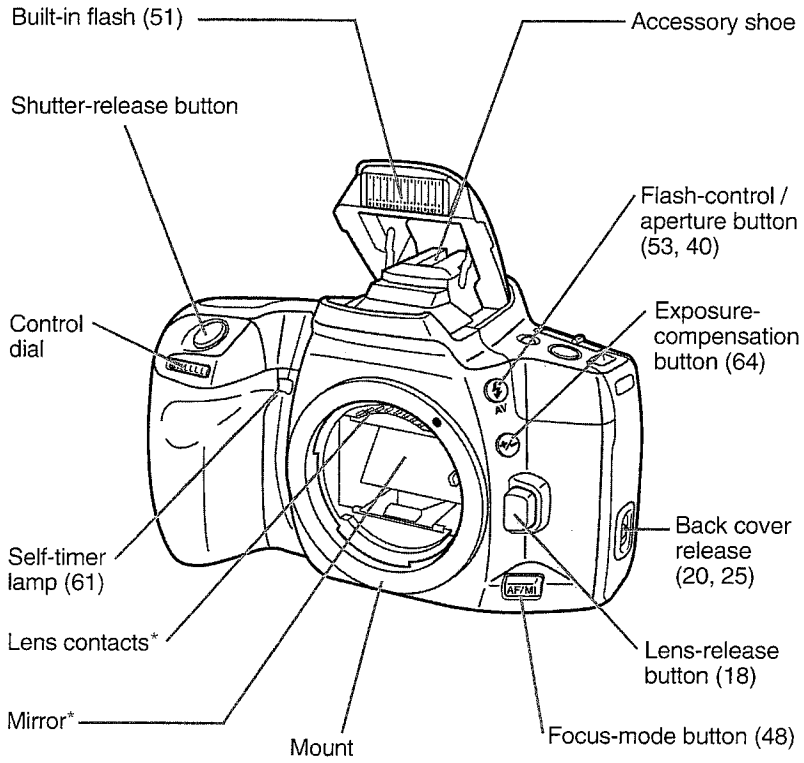

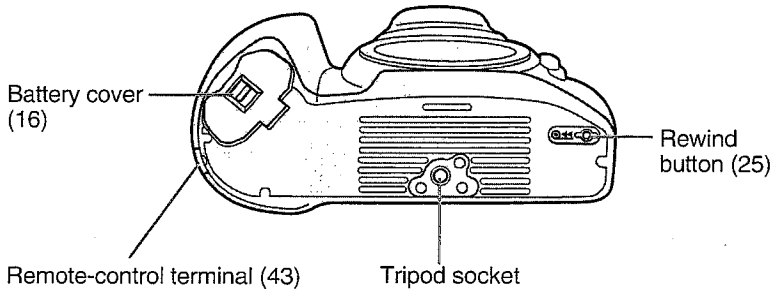
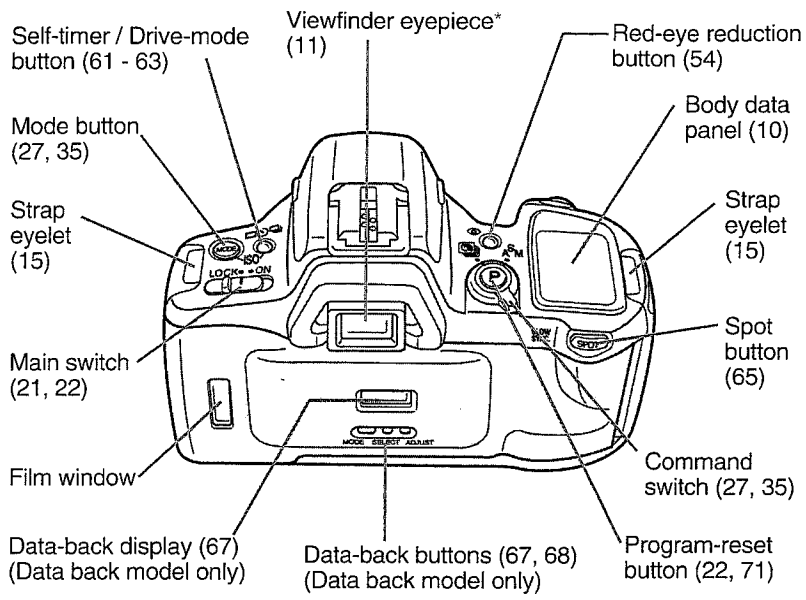

NAMES OF PARTS

DATA PANEL

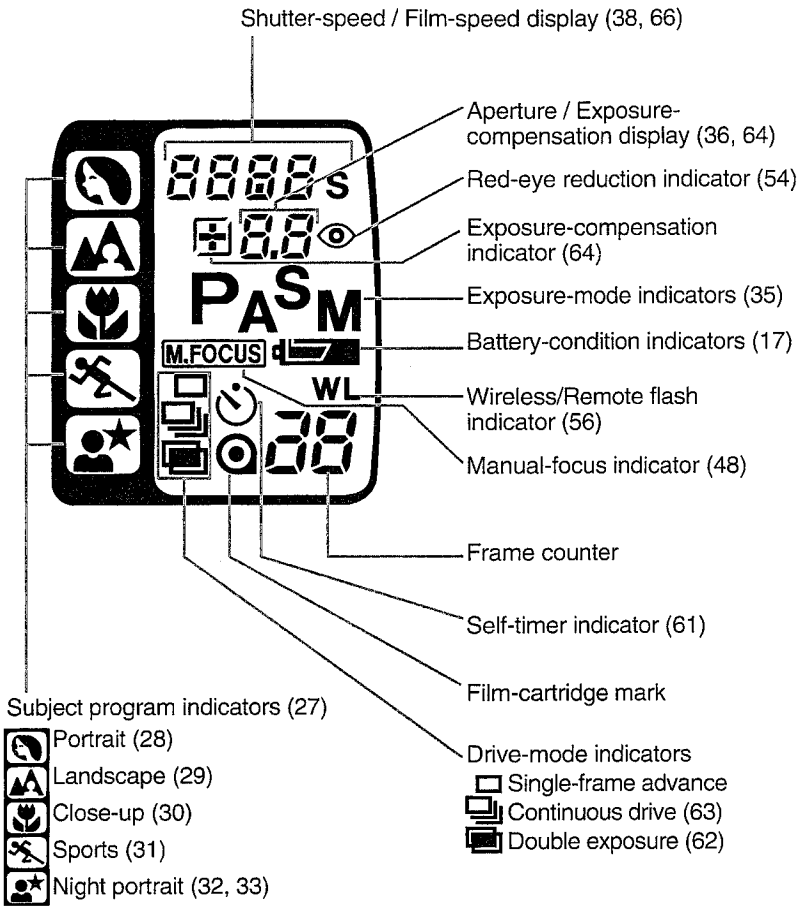

VIEWFINDER

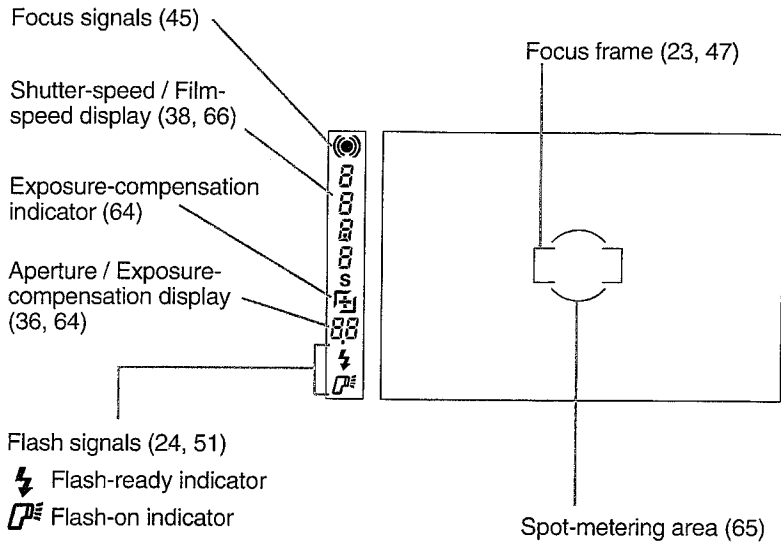

NOTE:

In this manual, glowing and blinking displays or indicators are identified as follows:



Glowing



Blinking

QUICK OPERATION

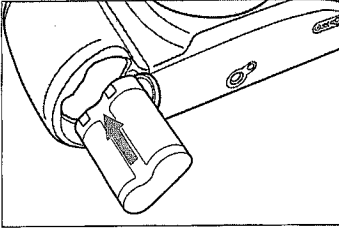

1. Insert battery

Insert one 6-volt 2CR5 lithium battery into the chamber as indicated by the + and - marks on the inside of the battery cover.

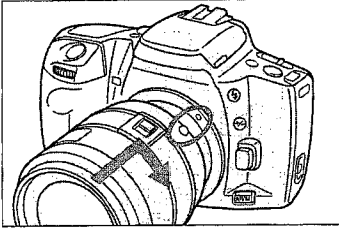

2. Attach lens

Align the red mounting index on the lens with the one on the camera. Gently insert the lens into the mount and turn it clockwise until it clicks into the locked position.

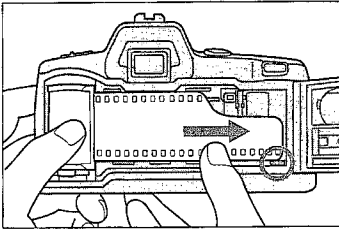

3. Load film

Insert the film and extend the film tip to the film leader index. Make sure the film is lying flat between the guide rails and close the back cover.

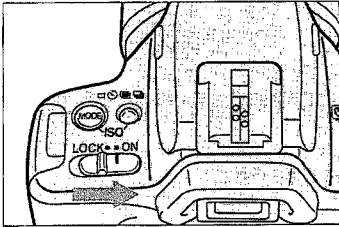

4. Turn on power

Turn the camera power on by sliding the main switch to ON.

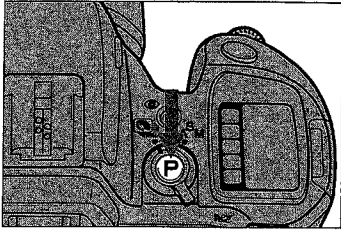

5. Set Full-Auto mode

Press the program reset button to set the camera to fully automatic mode.

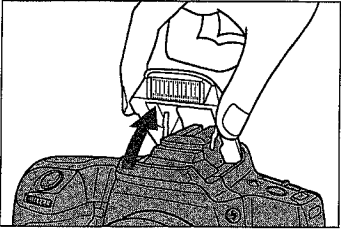

6. Lift built-in flash

Grip both sides of the flash and gently lift it. The flash will automatically fire when necessary.



7. Focus on subject

Align the subject within the focus frame and press the shutter-release button partway down to activate autofocus. The focus lock indicator will glow when the subject is in focus.

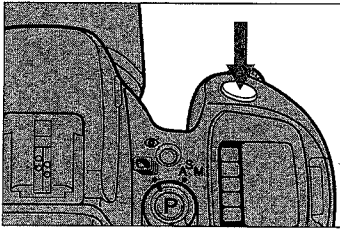

8. Take the picture

Gently press the shutter-release button all the way down to take the picture.

BASIC OPERATION

ATTACHING THE CAMERA STRAP

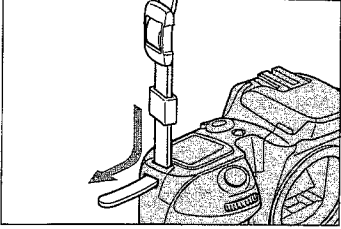

1. Undo the camera strap buckle and loop the strap through the eyelet of the camera.

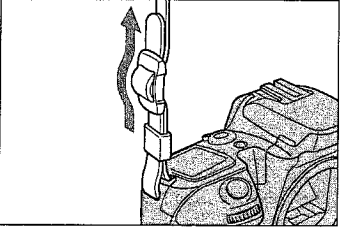

2. Redo the camera strap buckle.
3. Repeat for the other side.

INSERTING THE BATTERY

Your camera uses one 6-volt 2CR5 lithium battery which supplies power for all camera operations. Please read all warnings in the Safety cautions section of this manual as well as those supplied by the battery manufacturer.

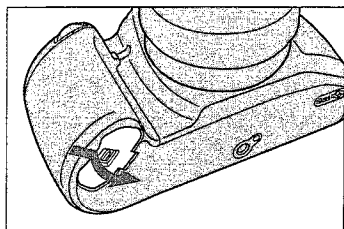

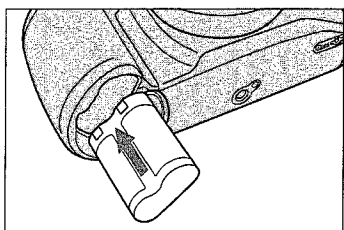

1. Open the battery chamber cover by pushing the cover release in the direction of the arrow.



2. Insert the battery into the chamber as indicated by the + and - marks inside the battery cover.
3. Close the cover until it clicks and locks closed.

CHECKING THE BATTERY POWER

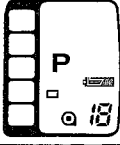
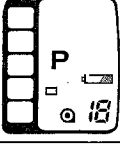
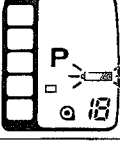
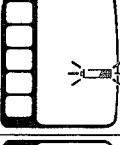
Your camera is equipped with a automatic battery power indicator. Each time the main switch is turned ON a symbol will appear in the data panel to indicate the power status of the battery. It is recommended that you always carry a spare battery in your camera bag.

	Full-battery symbol -- power is sufficient for all camera operations.
	Low-battery symbol -- power is sufficient for all camera operations, but is getting low. Keep new battery handy.
	Blinking low-battery symbol appears -- power is extremely low but all functions are operational. Battery will have to be replaced very soon. Flash recycling time may be slow.
	Blinking low-battery symbol appears by itself and the shutter locks -- power is insufficient for camera operation. Replace the battery immediately.
	No data appears in the data panel. Replace the battery or check that it is inserted correctly.

ATTACHING AND REMOVING THE LENS

ATTACHING THE LENS

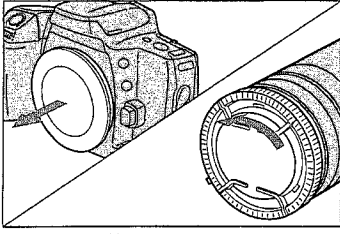

1. Remove the camera body cap and rear lens cap as shown.

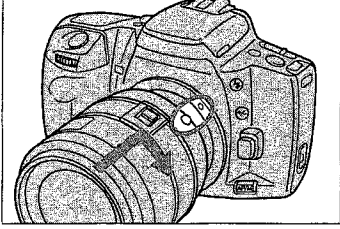

2. Align the red mounting index on the lens with the one on the camera.
3. Gently insert the lens into the mount and turn it clockwise until it clicks into the locked position.

REMOVING THE LENS

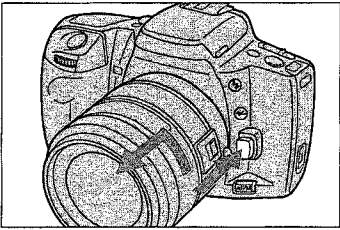

1. Press the lens-release button and hold it while turning the lens counter-clockwise until it stops.
2. Gently remove the lens from the mount and replace caps or immediately attach another lens.

Caution

- Do not force the lens if it does not turn smoothly.
- Do not touch the inside of the camera, especially the lens contacts and mirror.

HANDLING THE CAMERA

HOLDING THE CAMERA

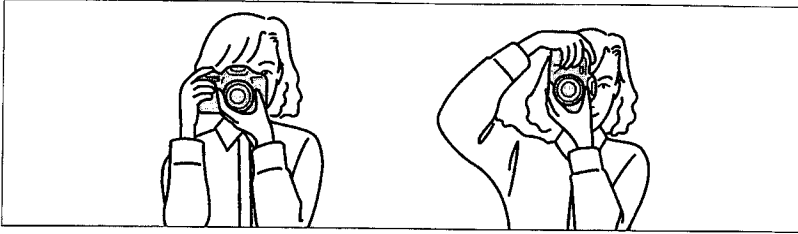

Hold the camera grip firmly with your right hand while supporting the camera or lens with your left hand. Make sure that your fingers are not blocking any of the camera's features; they should fit securely around the grip. To hold the camera steady, always keep your elbows at your side and your feet shoulder-width apart for support. Always keep the camera strap around your neck or wrist in case you accidentally drop it.

PRESSING THE SHUTTER-RELEASE BUTTON

The shutter-release button has three positions. To activate the camera's autofocus and autoexposure systems press the shutter-release button part way down. To take the picture, gently (never with a quick jab) press the shutter-release button all the way down.

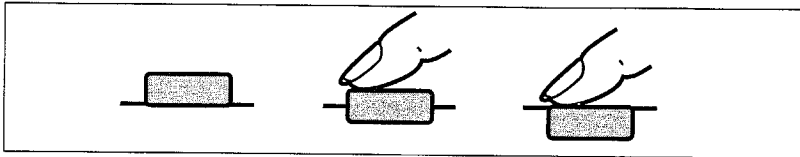

LOADING THE FILM

This camera is equipped with an automatic film transport system which automatically loads the film, sets the film speed, and advances the film after each exposure. **Before you open the back cover**, make sure that there is not a roll of film already in the camera.

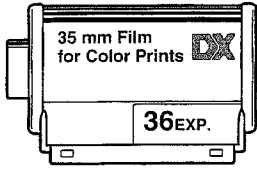

Use DX-coded negative or positive films, ISO 25 - 5000 for regular photographs or ISO 25 - 1000 for flash photographs. The camera will automatically set the proper film speed for the film you are using.

- Non-DX-coded film will be set to the previous film speed.
- Do not use Polaroid instant film or infrared film with this camera.
- Always load and unload film in subdued light.

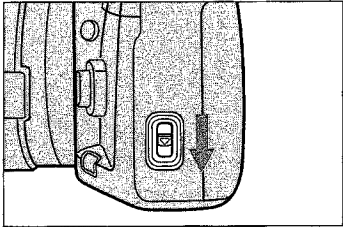

1. Slide the back-cover release down and open the back cover.

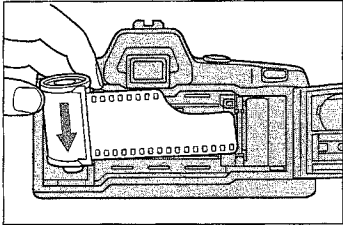

2. Place the film cartridge in the chamber making sure that it is seated properly.

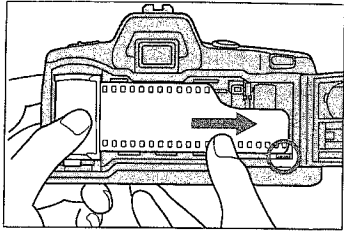

3. Extend the film tip to the film leader index making sure that it lies flat between the film guide rails.

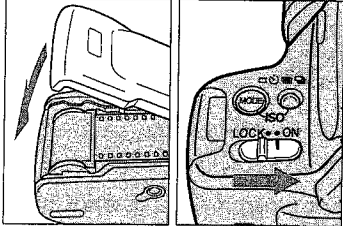
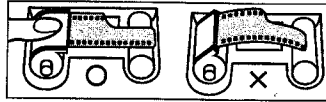

4. Close the back cover.
5. Slide the main switch ON. The film will automatically advance to the first frame.

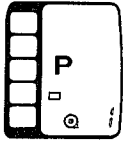

If the film has been loaded correctly, 1 will appear in the frame counter.

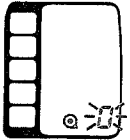

If the film has been loaded incorrectly, 0 will blink in the frame counter. Open the back cover and repeat the loading procedure.

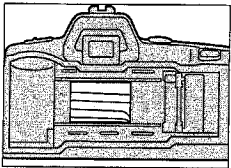

NEVER TOUCH THE SHUTTER CURTAIN WITH YOUR FINGERS OR FILM TIP.

Its precision design makes it extremely sensitive to pressure.

TAKING PICTURES IN PROGRAM MODE

Program mode is the camera's standard operating mode and is suited for use in virtually any situation. When you press the the program-reset button, all the camera's functions are set to fully automatic operation.

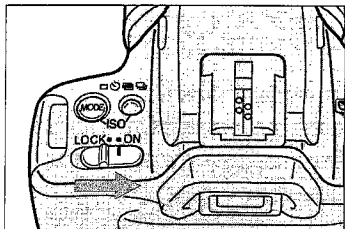

1. Slide the main switch to ON.

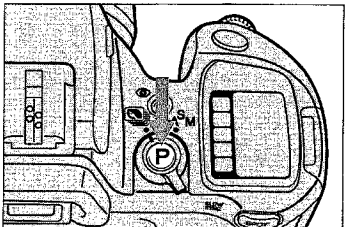

2. Press the program reset button to set the camera to fully automatic mode.

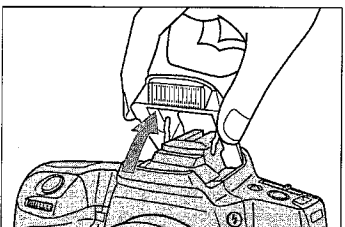

3. Grip both sides of the built-in flash and gently lift. If the flash will fire with the next shutter-release, P^F appears in the viewfinder when you press the shutter-release button partway down. See page 24.

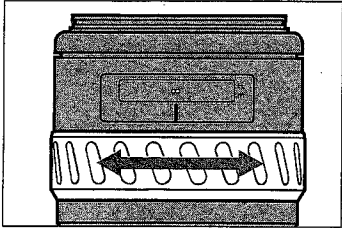

4. If you are using a zoom lens, rotate the zooming ring on the lens to frame your subject as desired.



5. Align your subject within the focus frame [] and press the shutter-release button partway down to activate autofocus. The focus lock indicator ● will glow when the subject is in focus. See page 45 for focus signals.

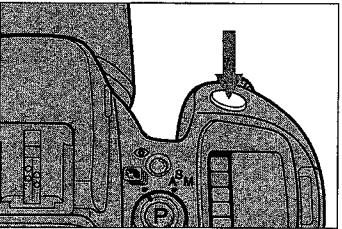

6. Press the shutter-release button all the way down to take the picture.

• When you want to take a picture with your subject outside the focus frame [], see page 47.

TAKING PICTURES IN PROGRAM MODE

USING FLASH

When the built-in flash is up, it will automatically fire in low-light or back-lit situations.

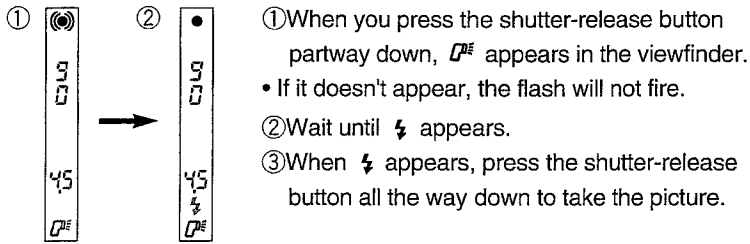

- ⚡ blinks rapidly after the picture is taken. If it doesn't blink, flash output was not sufficient to provide a correct exposure. Make sure your subject is within the flash range (See page 52).

LOOKING THROUGH THE VIEWFINDER

The following indicators will appear in the viewfinder when the shutter-release button is pressed partway down.

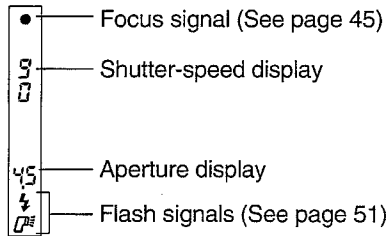

REWINDING THE FILM

This camera will automatically rewind the film after the last frame has been exposed. 0 will appear in the frame counter and the cartridge indicator will blink.

REMOVING THE FILM

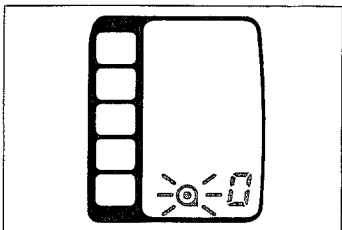

1. Wait for the film to rewind completely. 0 will appear in the frame counter and the cartridge indicator will blink.

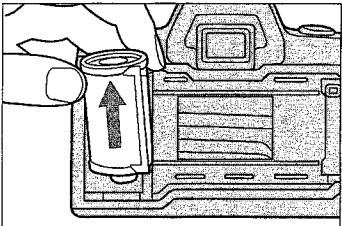

2. Open the back cover and remove the film as shown.

STARTING MANUAL REWIND

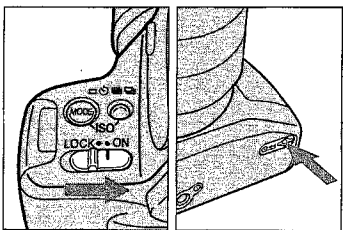



1. Slide the main switch to ON.
2. Gently press the rewind button.
3. Wait for the film to rewind completely and remove the film.

SUBJECT PROGRAM MODES

SUBJECT PROGRAM SELECTION

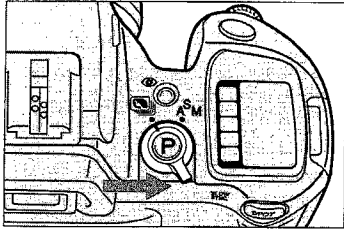
Subject program selection allows you to choose five different subject program modes: Portrait, Landscape, Close-up, Sports and Night Portrait. These program modes allow you to tell the camera what type of picture you will be taking so that it may customize the exposure settings for that type of picture.





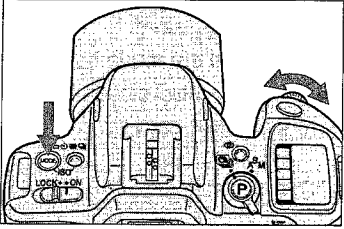

1. Set the command switch to .



2. Press and hold the mode button, then turn the control dial until the desired indicator blinks in the data panel.

• The mode is selected when you release the mode button.

- | | | |
|---|----------------------------|--|
|  | Portrait Mode | Portrait photography |
|  | Landscape Mode | Scenic and Travel photography |
|  | Close-up Mode | Macro photography |
|  | Sports Mode | Sports and Action photography |
|  | Night Portrait Mode | Night Portrait and Night Scene photography |



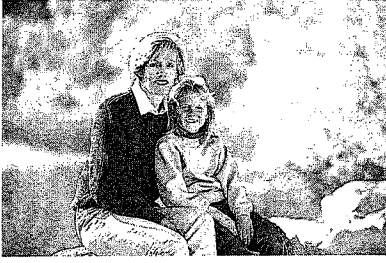

PORTRAIT MODE

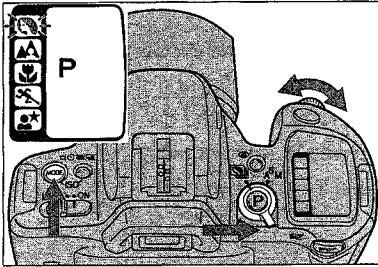

Portrait mode is best suited for photographing people. Portrait photography benefits from a shallow depth of field (the distance in front and behind your subject which will appear in focus) which isolates the person from the background. In portrait mode the camera will adjust

its settings to obtain this effect leaving you free to compose the picture and capture the perfect expression.



1. Set the Command switch to .
2. Press and hold the mode button, then turn the control dial until  blinks in the data panel.

Lens Tips:

Use a mid-telephoto lens with a large aperture for best results.

Flash Tips:

Use flash when your subject is backlit or when there are strong shadows across the face.

Additional Tips:

Lock focus on your subject's eyes and be ready to capture the perfect expression.





LANDSCAPE MODE

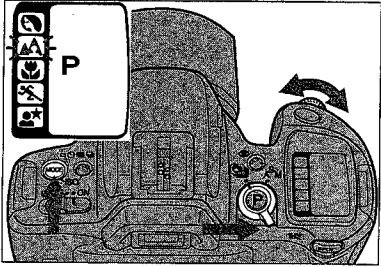

Landscape mode is suited for photographing landscape, scenic or travel photographs. Landscape photography generally requires a large depth of field to make sure that everything is in focus. In Landscape mode the camera is automatically set to the smallest aperture possible while maintaining a shutter speed fast enough to prevent blur due to camera shake.



1. Set the Command switch to .
2. Press and hold the mode button, then turn the control dial until  blinks in the data panel.

Lens Tips:

Use wide-angle lenses to create a feeling of depth in your picture.

Flash Tips:

Flash is only needed when there is a person in your photograph who is backlit or has strong shadows across the face.

Additional Tips:

Use a tripod to get sharp pictures, especially at slower shutter-speeds.





CLOSE-UP MODE

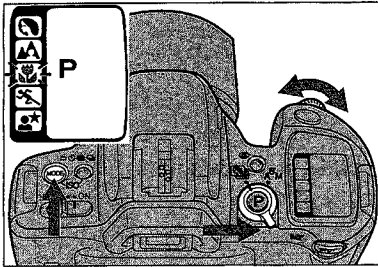

Close-up mode is best suited for photographing small subjects such as flowers at close distances. Close-up photography requires accurate focusing, so it is recommended that you use focus lock or manual focus to make sure the main part of your subject is in sharp focus. In Close-

up mode the camera will automatically set the best possible aperture and shutter speed for your subject.



1. Set the Command switch to .
2. Press and hold the mode button, then turn the control dial until  blinks in the data panel.

Lens Tips:

Use one of Minolta's macro lenses or a macro-capable zoom lens.

Flash Tips:

Do not use built-in flash when your subject is closer than 1m (3.3 ft.); lens shadowing may occur. We recommend the use of Macro Flash 1200AF Set.

Additional Tips:

Accurate focus is very important, make sure that you focus on the main part of your subject. Use a tripod to reduce camera shake.





SPORTS MODE

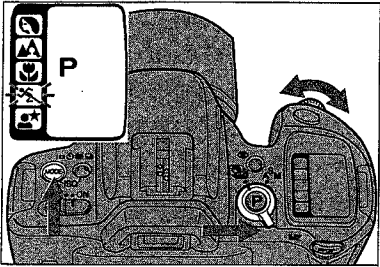

Sports mode is suited for photographing fast action events which require a fast shutter speed to stop the action. In Sports mode the camera automatically sets the fastest possible shutter speed and continuously adjusts the focus to track fast-moving subjects.



1. Set the Command switch to .
2. Press and hold the mode button, then turn the control dial until  blinks in the data panel.

Lens Tips:

Use large aperture telephoto lenses which allow the camera to select faster shutter-speeds.

Flash Tips:

Using flash will only help if your subject is within the flash range (See page 52). Powerful accessory flashes have longer ranges.

Additional Tips:

Use fast film (ISO 400 or higher) and keep the focus frame on your subject.





NIGHT PORTRAIT MODE

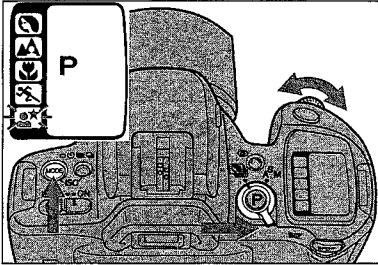

Night Portrait mode is suited for portraits and scenic photography at night. Nighttime photography requires the camera to balance the camera's flash with the background. In this mode, the camera uses the largest aperture possible with a longer shutter speed which allows

the background to appear in the photograph.



1. Set the Command switch to .
2. Press and hold the mode button, then turn the control dial until  blinks in the data panel.
3. Lift the built-in flash.

Flash Tips:

Use flash when your subject is in front of your night scene.

Additional Tips:

Use faster film (ISO 400 or greater), use a tripod, and focus on the main part of your subject. Warn your subject not to move while the picture is taken.

PHOTOGRAPHING NIGHT SCENES

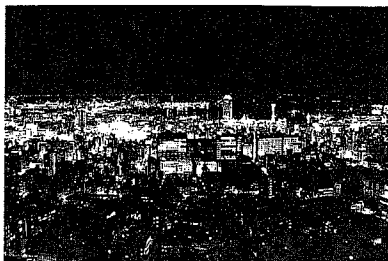

Night Portrait Mode can be used for photographing night scenes as well as portraits simply by cancelling the flash. This mode sets long shutter speeds so you can easily capture beautiful photographs of twilight scenes and night skylines.

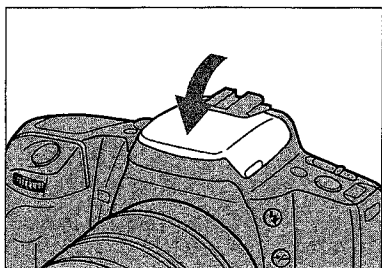

After setting night portrait mode, push down the built-in flash.

Flash Tips:

Do not use flash if you are only photographing a night scene.

Additional Tips:

Use faster film (ISO 400 or greater) and use a tripod. If you are photographing dark night scenes, pictures may not appear clear. If it is difficult to focus, use focus lock (page 47).

CREATIVE EXPOSURE MODES

CREATIVE EXPOSURE SELECTION

Creative exposure selection allows you to choose any of four separate exposure modes: Aperture-priority, Shutter-priority, Manual, and Program mode. While the subject program modes allow you to match the camera to the photographic situation, the exposure modes enable you to tailor the camera's operation to your vision of the end result and the degree of camera control you desire. For information on P mode, refer to "Taking Pictures in Program Mode" beginning on page 22.

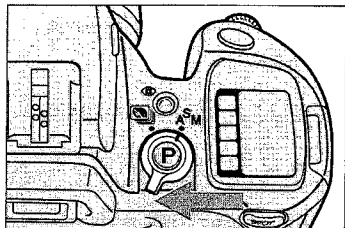

1. Set the command switch to A^SM.

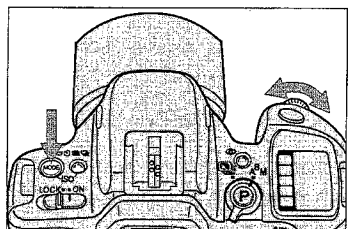

2. Press and hold the mode button, then turn the control dial until the desired indicator blinks in the data panel.

- The mode is selected when you release the mode button.

A	Aperture-Priority Mode	Manually select aperture
S	Shutter-Priority Mode	Manually select shutter speed
M	Manual Exposure	Manually select aperture and shutter speed

A MODE: APERTURE PRIORITY

In A mode, you select the aperture and the camera automatically sets the shutter speed required for proper exposure. This mode should be used when you want to control the range of sharpness (i.e., depth of field) in a photograph. Large apertures (small numbers) provide a short depth of field which is ideal for portraits.

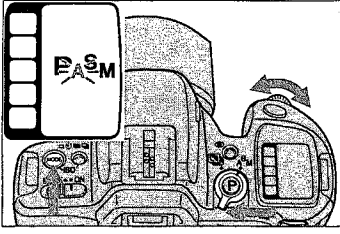

1. Set the Command switch to A^SM.
2. Press and hold the mode button, then turn the control dial until **A** blinks in the data panel.

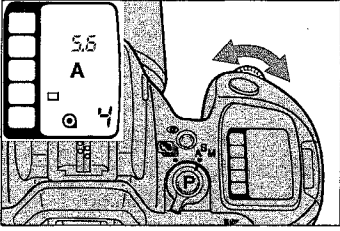

3. Release the mode button and turn the control dial to select the aperture you want.
4. Compose your photograph and take the picture.

- If 2000 or 30s blinks, the required setting is beyond the camera's shutter speed range. Turn the control dial until the blinking stops. (See "Trouble Shooting" beginning on page 74 for more exposure warnings.)
- See page 53 for flash exposure in A mode.

APERTURE CONTROL



Large Aperture



Small Aperture

The size of the aperture determines the intensity of the light falling on the film as well as the depth of field in the final image. Depth of field is the range in front of and behind the point where the lens is focused which will appear sharp.

Large apertures (small numbers) limit depth of field to a narrow range near the focus point. This is useful whenever you want to place greater visual emphasis on your main subject by intentionally blurring the background, such as in the case of portraits. Small apertures (large numbers) provide greater depth of field, bringing an increasingly greater range into focus. This is important when you are photographing landscapes to ensure that your entire scene is sharp.

LENS APERTURES



1.4 1.7 2 2.4 2.8 3.5 4 4.5 5.6 6.7 8 9.5 11 13 16 19 22 26 32

- Usable apertures will depend on the aperture range of the lens you are using.

S MODE: SHUTTER PRIORITY

S mode lets you select the shutter speed and the camera automatically sets the aperture for the best exposure. This mode is very useful for photographing moving subjects when you want to control subject blur. Faster shutter speeds can freeze the subject.

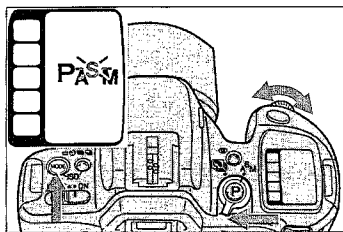

1. Set the Command switch to A^SM.
2. Press and hold the mode button, then turn the control dial until **S** blinks in the data panel.

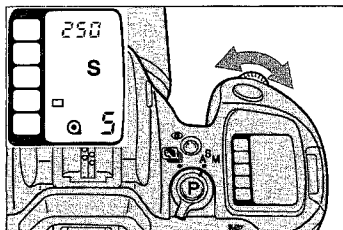

3. Release the mode button and turn the control dial to select the shutter speed you want.
4. Compose your photograph and take the picture.

- If the aperture display blinks, the required setting is outside the aperture range of the lens. Turn the control dial until the blinking stops. (See "Trouble Shooting" beginning on page 74 for more exposure warnings.)
- See page 53 for flash exposure in S mode.

SHUTTER SPEED CONTROL



Fast Shutter Speed



Slow Shutter Speed

In addition to controlling the duration of the exposure, the shutter speed is an important factor in determining how moving subjects will appear in the final image. Depending on the speed of your subject, slow shutter speeds will make a moving subject appear to flow, creating a greater feeling of motion. Fast shutter speeds, of course, are useful to freeze fast action.

Your choice of shutter speed can also help prevent blurring caused by movement that occurs during exposure, known as "camera shake". For focal lengths longer than $f = 50\text{mm}$, a general rule to follow is that $1/f$ is the slowest usable shutter speed while the camera is being hand-held. For example, if you are using a 135mm lens, try to avoid using shutter speeds slower than $1/250$ sec. if you are not using a tripod.

CAMERA SHUTTER SPEEDS (in seconds)

← Faster Slower →

1/2000 1/1000 1/500 1/250 1/125 1/60 1/30 1/15 1/8 1/4 1/2 1 2 4 8 15 30

- 1/90 sec. is the camera's flash sync speed and can only be selected, manually or automatically, when the built-in flash is raised or an accessory flash is attached and activated. BULB can only be selected in M mode.

M MODE: MANUAL EXPOSURE

In M mode, you have full control of exposure. In this mode, you select any shutter speed and aperture. The viewfinder data panel will tell you if the exposure you have selected is over, under, or the same as the camera's metered exposure.

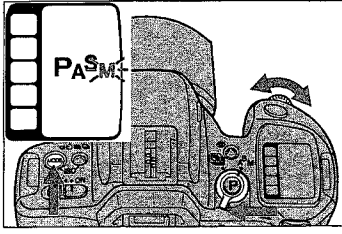

1. Set the command switch to A^SM.
2. Press and hold the mode button, then turn the control dial until **M** blinks in the data panel.

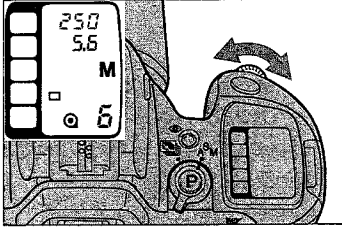

3. Release the mode button and turn the control dial to select the shutter speed you want.

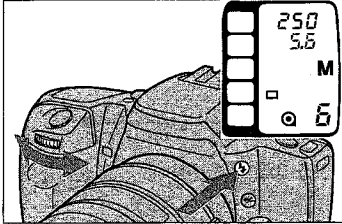

4. Press and hold the flash-control / aperture button, then turn the control dial to select the aperture you want.
5. Compose your photograph and take the picture.

EXPOSURE CONTROL

Exposure is the quantity of light that reaches the film when you press the shutter-release button. This quantity is determined by the intensity of the light that falls on the film and the time that the film is exposed to light.

In M mode, you have full creative control over both of these variables: the aperture setting regulates the intensity of the exposure, and the shutter speed determines the time. By adjusting either of these in relation to the camera's metered exposure value, you can control the overall exposure of each image.

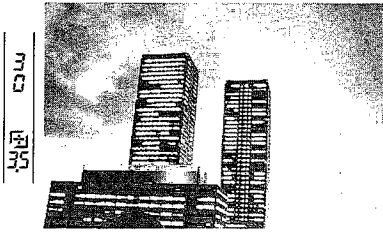

Over Exposure 

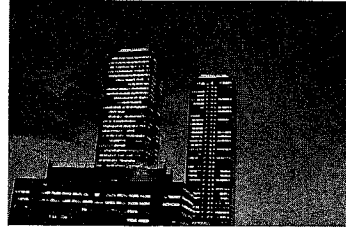

Under Exposure 

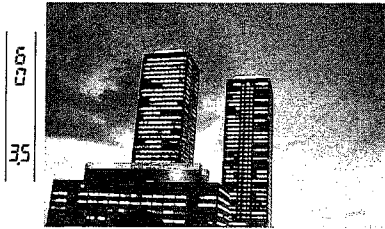

Metered Exposure

BULB



Bulb can only be used in M mode. When set the shutter will remain open as long as you press the shutter-release button. To avoid blurry pictures, mount the camera on a tripod.

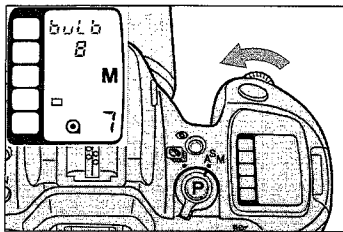

1. Select M mode.
2. Turn the control dial towards the slower shutter speeds until BULB appears in the data panel.

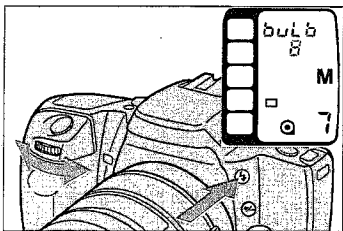

3. Press and hold the flash-control / aperture button, then turn the control dial to set the aperture.
4. Compose the picture.

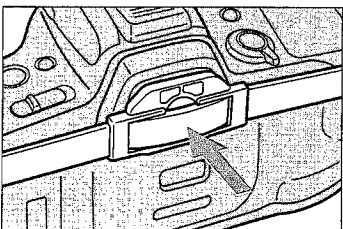

5. Attach the eyepiece cap.
 - To attach the eyepiece cap, firmly press the cap until it snaps into the eyepiece. This prevents stray light from entering the eyepiece and affecting exposure.

6. Press and hold the shutter-release button to take the picture.
- The shutter will remain open as long as you hold the shutter-release button down.

Using Remote Cord:

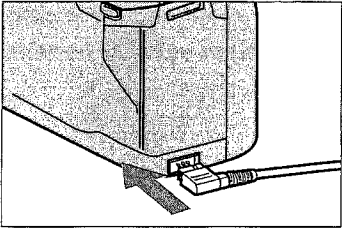

To avoid blurry pictures, use of the optional Remote Cord RC-1000S or L is recommended.

1. Remove the remote-control terminal cover.
2. Then insert the remote cord's plug into the terminal.

To Attach the Remote-Terminal Cover after use:

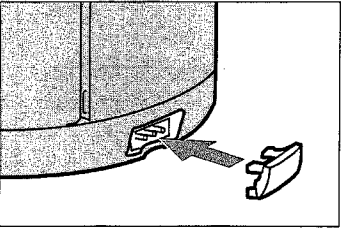

1. Align the prongs on remote-terminal cover with the remote terminal.
 2. Carefully press the cover until it attaches.
- Do not force the cover at an angle. Prongs may snap.

FOCUS

FOCUSING

This camera is set to autofocus (AF) mode each time the camera is switched ON. Pressing the shutter-release button partway down will activate the autofocus system and one of the signals below will appear in the viewfinder. In autofocus mode, the shutter will not release until focus is confirmed.

FOCUS SIGNALS



Continuous autofocus; focus is confirmed.



Focus is confirmed and locked.



Focus is not possible (shutter locked). Your subject is too close or is one of the special focusing situations described on the next page.



Continuous autofocus; lens focusing (shutter locked).

SPECIAL FOCUSING SITUATIONS

In the situations described below or similar situations, it may be difficult or impossible for the camera to focus accurately. In such situations, you should use focus lock or manual focus which are described on the following pages.

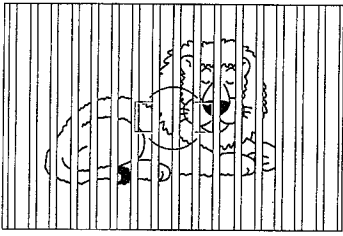

If two subjects at different distances overlap within the focus frame [].

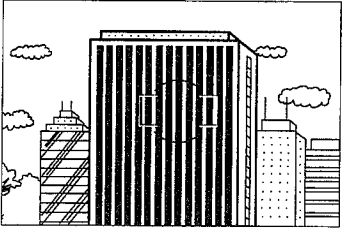

If a subject composed of alternating light and dark lines completely fills the focus frame [].

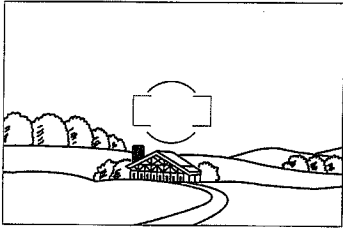

If the subject within the focus frame [] is very bright or low-contrast.

FOCUS LOCK

Focus lock should be used when you want to take a picture with your subject outside the focus frame [] or in situations where autofocus is difficult to confirm.



1. Place your subject within the focus frame [] and press the shutter-release button partway down.

- The focus lock indicator ● will glow when focus is locked.



2. Continue to hold the shutter-release button partway down while you recompose your picture as desired.

3. Press the shutter-release button all the way down to take the picture.

- Focus lock cannot be used with moving subjects.

Alternate Focus Lock Methods:

- If you are using a manual zoom lens which has a focus-hold button, you can lock focus by pressing the focus-hold button.
- If you are using an AF Zoom xi or AF Power Zoom lens, you can lock focus by pulling the lens control ring towards you.

MANUAL FOCUS

In situations where the autofocus system is not suitable and focus lock is not possible, you may focus the lens manually. The autofocus system will continue to monitor focus and will indicate when the subject within the focus frame is in focus.

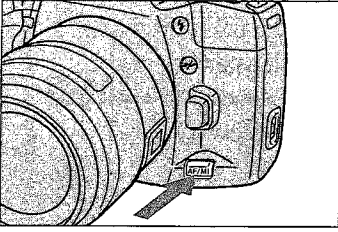

1. Press the focus-mode button so that the manual focus indicator **M.FOCUS** appears in the data display.

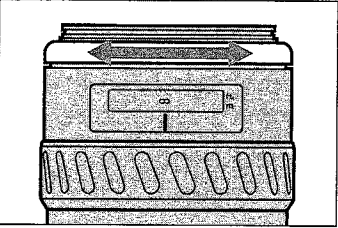

2. Look through the viewfinder and turn the lens focusing ring until your subject appears clear and sharp.

- If you are using an xi-series or power zoom lens, pull the control ring towards you and then rotate it in either direction to focus.

AUTOFOCUS ILLUMINATOR

If the flash is raised and the camera detects that the scene is too dark to focus accurately, the flash will automatically fire a few short bursts before and after the lens focuses (AF illuminator). This provides the light necessary for the camera to detect and focus on your subject.

- The range of the AF illuminator flash is approximately 1 to 5m (3.3-16 ft.).
- AF illuminator flash may not fire when the focal length you are using is 300mm or more, or when the AF Macro Zoom 3X - 1X is used.

TO TURN THE AF ILLUMINATOR OFF:

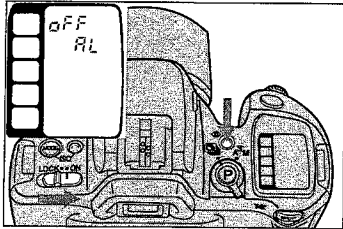

Press and hold the red-eye reduction button while you turn the camera on.

- "OFF AL" appears in the data panel.

- To turn the AF illuminator on again, repeat the procedure so that "ON AL" appears in the data panel.

FLASH

USING THE BUILT-IN FLASH

The built-in flash provides coverage for lens focal lengths as short as 28mm. The flash output is controlled automatically by the camera's TTL (through-the-lens) flash metering system.

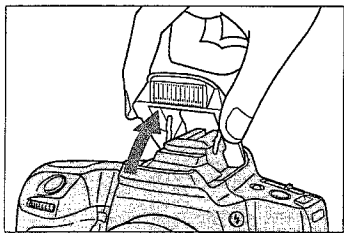



Grip both sides of the flash and gently lift it. If the flash will fire with the next shutter release,  appears in the viewfinder when you press the shutter-release button partway down. After you have finished using flash, push it back down.

FLASH SIGNALS

 Built-in flash is up or attached accessory flash is on and charging.

 Flash is charged and will fire when the shutter-release button is pressed.

 (After picture is taken, blinks rapidly) Flash output was sufficient to provide a correct exposure.

 Lighting conditions require flash. Raise the built-in flash or attach an accessory flash.

- If  doesn't blink after picture is taken, flash output was not sufficient. Make sure your subject is within the flash range (see next page), and release the shutter after flash is charged.

BUILT-IN FLASH PRECAUTIONS

FLASH RANGE

The range of the built-in flash varies depending on the speed of the film and the maximum aperture of the lens being used, please take note to the working range of the built-in flash.

APERTURE	ISO 100	ISO 400
f/2.8	1.0 - 4.2 m 3.3 - 13.8 ft.	1.0 - 8.4 m 3.3 - 27.5 ft.
f/4	1.0 - 3.0 m 3.3 - 9.8 ft..	1.0 - 6.0 m 3.3 - 19.7 ft.
f/5.6	1.0 - 2.1 m 3.3 - 6.9 ft..	1.0 - 4.2 m 3.3 - 13.8 ft.

For example, when you use 28-80mm f/4-5.6 lens and film with ISO 100 and take built-in flash pictures, flash range is 1.0-3.0m at 28mm and 1.0-2.1m at 80mm.

CAUTION : LENS SHADOWING MAY OCCUR

Lens shadowing may occur in the bottom of your pictures when using the built-in flash with certain Minolta AF lenses. To reduce the chance of shadowing, never use a lens wider than 28mm, never use a lens hood, and do not photograph closer than 1m (3.3 ft). The following lenses may cause shadowing at the wider focal lengths:

- AF Zoom 28 - 70mm f/2.8
- AF Zoom 28 - 135mm f/4-4.5
- AF Zoom 28 - 85mm f/3.5-4.5
- AF Zoom 35 - 200mm xi f/4.5-5.6

Built-in flash should not be used with the following lenses:

- AF 300mm f/2.8 APO
- AF 600mm f/4 APO

USING FLASH IN P, A, S, M MODES

USING FLASH IN P MODE

When the built-in flash is up or an attached accessory flash is on, it will automatically fire in low-light or back-lit situations. The camera will select the most appropriate shutter speed and aperture settings.

TO FIRE THE FLASH MANUALLY

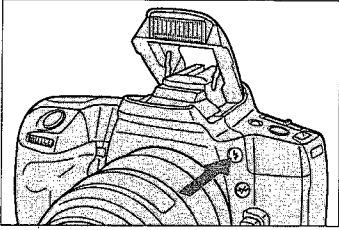

In P Mode, you can manually fire the built-in flash or accessory flash. Press and hold the flash-control / aperture button while you take the picture.

USING FLASH IN A, S, M MODES

When the built-in flash is up or an attached accessory flash is on, it will fire each time you take a picture. When the built-in flash is down or an attached accessory flash is off, it will not fire.

A MODE FLASH: You can select any aperture setting and the camera automatically sets the shutter speed.

S MODE FLASH: Operation in S mode is the same as in P mode. The camera automatically sets the aperture setting and shutter speed.

M MODE FLASH: You can select any aperture setting and shutter speeds between 1/90 and 30 second, including BULB.

RED-EYE REDUCTION

When photographing people or animals at night or in low-light situations, the effect called "Red-eye" may occur due to the flash reflecting off the inside of the subject's eyes. To reduce this effect and produce more natural and beautiful pictures, use the red-eye reduction mode with the built-in flash.

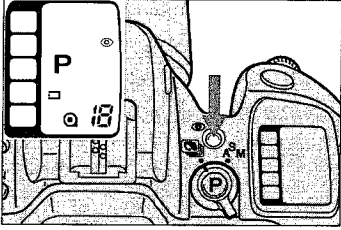

1. Press the red-eye reduction button so that the red-eye reduction indicator  appears in the data panel.

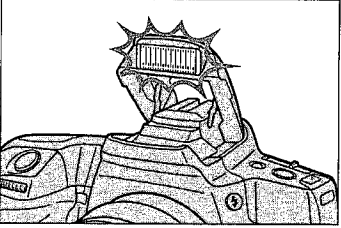

2. Warn your subject that the flash will fire a series of short flash bursts just before the picture is taken.

- To cancel the red-eye reduction, press the red-eye reduction button again so that  disappears in the data panel.

WIRELESS / REMOTE OFF-CAMERA FLASH CONTROL

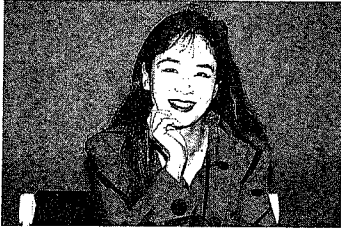

Normal Flash



Wireless / Remote Flash

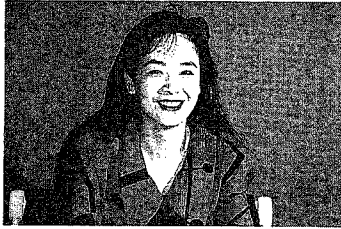

Wireless / Remote Ratio Flash

Wireless / Remote Off-Camera Flash Control is available with the Minolta accessory flashes: 5400HS, 5400xi, or 3500xi. Wireless / Remote flash allows you to experiment with creative lighting techniques using off-camera accessory flashes without a tangle of accessory cords and connectors.

In wireless / remote flash mode, the off-camera flash is triggered by a coded signal from the camera's built-in flash when you press the shutter-release button. Another signal stops it once the camera's TTL flash meter detects the proper exposure has been received. You can also obtain a 2:1 lighting ratio automatically. When selected, the off-camera flash provides 2/3 of the full exposure and the camera's built-in flash adds the remaining 1/3.

SETTING WIRELESS / REMOTE FLASH MODE

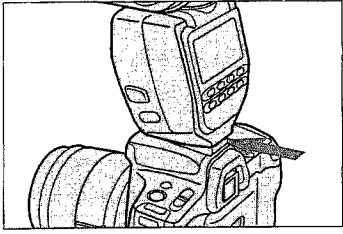

1. Attach the accessory flash (5400HS, 5400xi, or 3500xi) to the camera and turn both the flash and camera on.

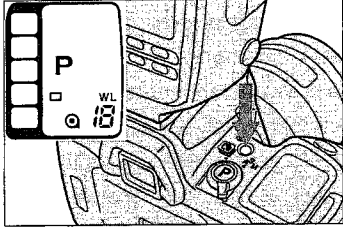

2. Press the red-eye reduction button - **WL** will appear in the data panel and the flash is now set for wireless / remote flash.

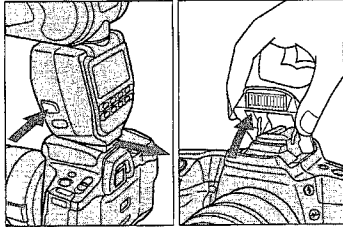

3. Remove the accessory flash and raise the camera's built-in flash. The accessory flash is now ready to be positioned.

TAKING PICTURES IN WIRELESS / REMOTE FLASH MODE

1. Position your camera and 3500xi flash unit using the information of this page. If you are using a flash unit other than the 3500xi off-camera, refer to that flash instruction manual.

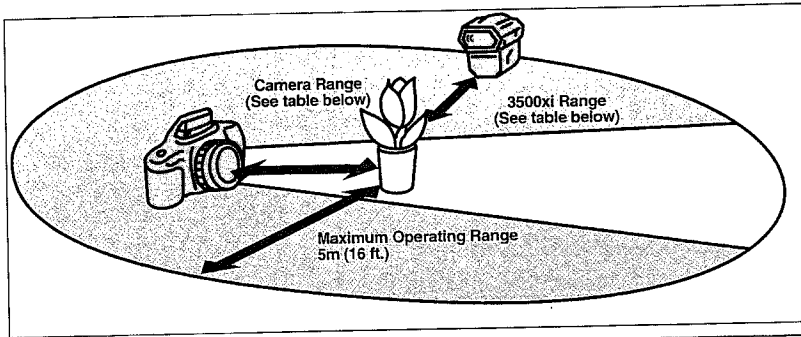

Aperture	Camera-Subject Distance		3500xi-Subject Distance	
	ISO 100	ISO 400	ISO 100	ISO 400
f/2.8	1.4-5m/4.6-16.4 ft.	2.8-5m/9.2-16.4 ft.	1-5m/3.3-16.4 ft.	2-5m/6.6-16.4 ft.
f/4	1-5m/3.3-16.4 ft.	2-5m/6.6-16.4 ft.	0.7-4.5m/2.3-14.7 ft.	1.4-5m/4.6-16.4 ft.
f/5.6	1-5m/3.3-16.4 ft.	1.5-5m/4.6-16.4 ft.	0.5-3.2m/1.6-10.5 ft.	1-5m/3.3-16.4 ft.

- The off-camera flash unit may not detect the control signals if it is behind the subject.

WIRELESS / REMOTE OFF-CAMERA FLASH CONTROL

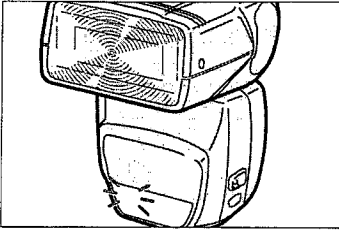

2. Wait for both the flashes to charge.
 - The accessory flash's AF illuminator will blink when the flash is fully charged.

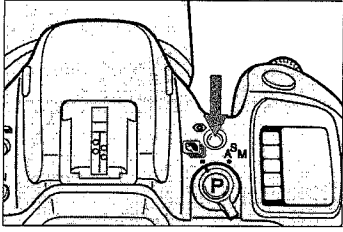

3. Press the red-eye reduction button to test fire the accessory flash and wait again for both flashes to charge.
4. Press the shutter-release button all the way down to take the picture.

CANCELLING WIRELESS/REMOTE FLASH

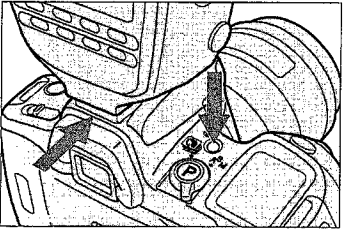

1. Reattach the accessory flash to camera.
2. Press the red-eye reduction button so that **WL** disappears in the data panel.

- To cancel wireless / remote flash mode on the 3500xi separately from the camera, first turn the flash off. Then, press the ON/OFF button to turn the flash on and hold the button until the wireless lamp turns off.
- To cancel wireless / remote flash mode on other flash units, refer to your flash owner's manual.

WIRELESS / REMOTE RATIO CONTROL

In wireless / remote mode when ratio control is selected, the output of the off-camera flash and built-in flash combine to provide a 2:1 lighting ratio.

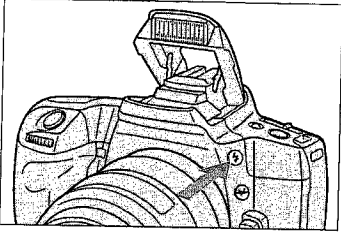

To use ratio control, press and hold the flash-control / aperture button, then press the shutter-release button all the way down to take the picture.



ADDITIONAL FEATURES

SELF-TIMER

The self-timer will delay release of the shutter for approximately 10 seconds after you press the shutter-release button giving you time to get in the picture.

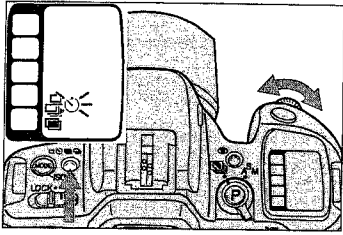

1. Press and hold the self-timer / drive-mode button, then turn the control dial until the self-timer indicator  blinks.

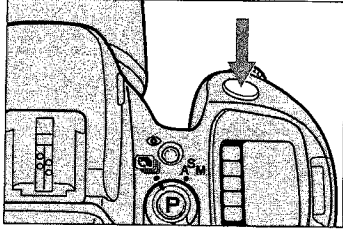

2. Compose the picture and press the shutter-release button all the way down to start the timer.
 - The self-timer lamp on the front of the camera will blink until the shutter-releases.
 - Self-timer mode will automatically cancel after the exposure is made.

- To cancel **self-timer** before the shutter releases, slide the main switch to LOCK.
- If you are not looking through the viewfinder when you press the shutter-release button, attach the eyepiece cap (p. 42) to prevent light from entering through the eyepiece and affecting the exposure reading.

DOUBLE EXPOSURE MODE



In double-exposure mode, two exposures are overlapped on the same frame.

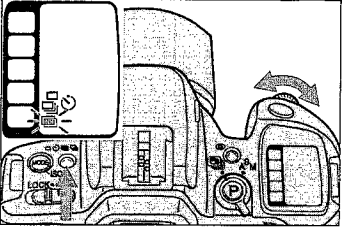

1. Press and hold the self-timer / drive-mode button, then turn the control dial until the double-exposure indicator  blinks in the data panel.

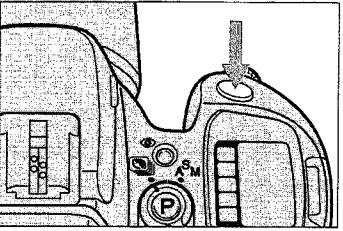

2. Compose your first picture and press the shutter-release button all the way down.
 - The frame counter blinks indicating that the first picture of the double exposure has been taken.

3. Compose your second picture and press the shutter-release button all the way down again.

- Double-exposure mode is automatically canceled after both exposures are made.
- To cancel the double-exposure mode before the second picture is taken, repeat the procedure so that the single-frame indicator  appears in the data panel.

CONTINUOUS-DRIVE MODE

In this mode, the camera continuously takes pictures and advances the film as long as the shutter-release button is held down.

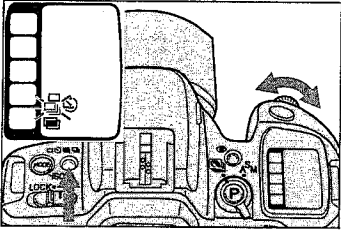

1. Press and hold the self-timer / drive-mode button, then turn the control dial until  blinks in the data panel.

2. Press the shutter-release button down and hold.

- The camera continuously makes exposures and advances the film up to 1 frame per second.
- When flash is being used, the shutter will release only after the flash is charged.
- When the subject is moving, the shutter will release after the camera focuses the subject.



EXPOSURE COMPENSATION

This function enables you to compensate exposure up to ± 3 EV in 1/2 EV increments in situations where the camera's metering system may not be able to determine accurate exposure. Increased exposure is recommended for scenes which are very bright, such as snow or beach scenes; similarly decreased exposure is recommended when the scene is composed of mostly darker tones like as shadow scene.

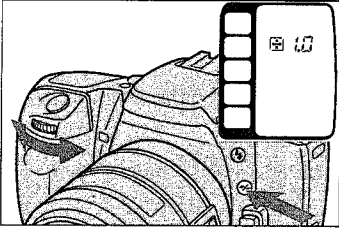

- Example photographs are shown in page 41.

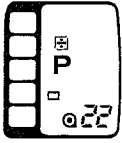

1. Press and hold the exposure-compensation button, then turn the control dial until the compensation value you want appears in the data panel.



2. Release the exposure-compensation button to enter the number.

-  or  will remain in the data panels as a reminder that exposure compensation is set.

- To cancel exposure compensation, perform the above procedure and select 0.0.

SPOT METERING

Spot metering should be used when you want to bias the exposure according to a very small section of the scene. The camera sets the exposure according to the brightness of the area inside the spot circle in the center of the viewfinder.



1. Center your subject inside the spot circle, and press the shutter-release button partway down to focus the subject.

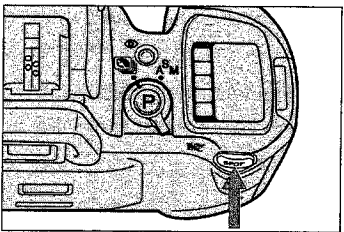

2. Press and hold the spot button.
 - Exposure is locked as long as you are pressing the spot button.



3. While continuing to hold the spot button, recompose the picture if needed, and press the shutter-release button all the way down to take a picture.

- Spot metering is available only when the flash is not being used. If you press the spot button while the flash-on indicator **FP** appears, slow-shutter sync flash is set.

SETTING THE FILM SPEED MANUALLY

You may manually set the film speed when you are using non-DX-coded film or when you want to override the camera's automatic setting. Film speeds can be set manually from ISO 6 to 6400 in 1/3 EV increments.

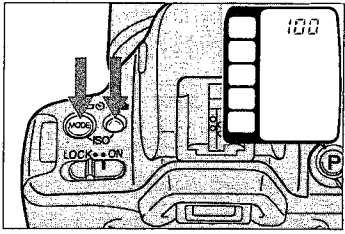

1. Press and hold the mode and drive-mode buttons.
- The film speed setting appears in the body data panel.

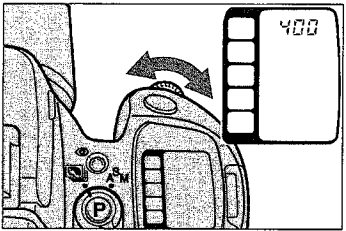

2. While continuing to hold the buttons down, turn the control dial to set the desired film speed.

OPTIONAL QUARTZ DATA BACK MODEL

For the owner of the Quartz Data Model, this camera is equipped with a Quartz Data Back which automatically imprints the date or time in the lower-right corner of the picture as a record of when the picture was taken. The calendar and quartz-controlled clock may be switched off when imprinting is not desired.

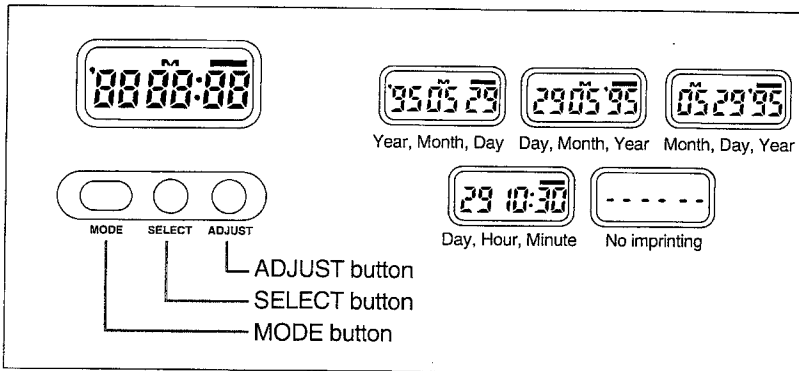

DATA IMPRINTING

Press MODE button to select date or time imprinting.

- "M" will appear above the month.
- Imprinted data may be difficult to read if the printing area is bright, orange, or not uniform.
- Do not use the data back when temperatures exceed the operating temperature range of 0° to 50°C (32° to 122°F).

SETTING DATA

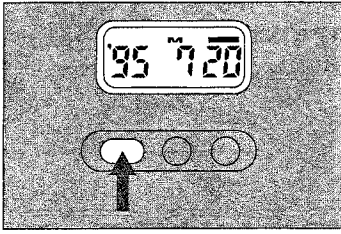

1. Press the **MODE** button to choose either Date or Time mode.

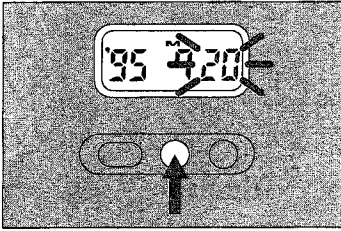

2. Use the **SELECT** button to move between different parts of the displayed data.
 - The selected part will blink indicating it is the data to be changed.

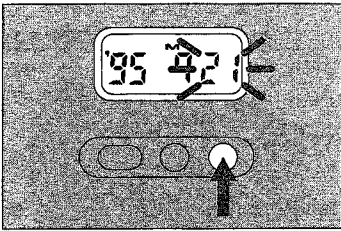

3. Press the **ADJUST** button to change the data to the correct value.
 - The data will continue to change if the **ADJUST** button is held down.
 - In time mode, pressing the adjust button while the colon (:) is blinking will reset the seconds counter to 00.

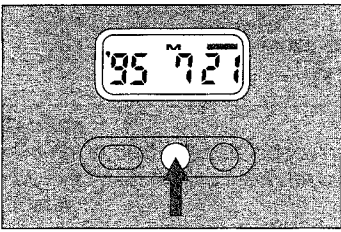

4. When all data is correct, press the **SELECT** button until the data stops blinking.
 - " — " will appear in the display.

REPLACING THE QUARTZ DATA BACK BATTERY

The data back uses a 3-volt lithium battery (CR2025). Change the battery when the imprinted data or data panel become dim.

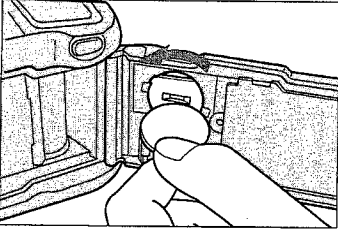

1. Open the back cover by pressing the back cover release down.
2. Using a coin or screwdriver, remove the battery cover by turning counter-clockwise as shown.

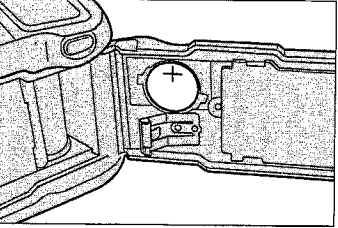

3. Remove the old battery and replace it with a new one; making sure that the + indicator is facing upward.
4. Replace the battery cover by turning clockwise. The time and date will have to be reset.
5. Reset the time and date.

CAUTION

- Make sure there is no film in the camera before opening the back cover.
- Do not touch any other parts inside the camera other than the data back battery cover.

APPENDIX

PROGRAM-RESET BUTTON

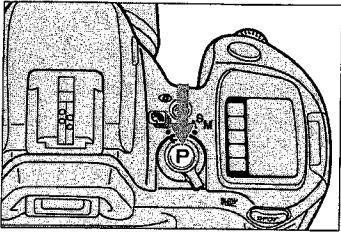

The program-reset button is a quick way for you to return the camera to Full-Auto Operation. Whether the Command switch is set to a Subject Program mode or Creative Exposure mode, pressing the program-reset button will set the camera to the following:

FUNCTION	P-MODE SETTING
Exposure mode	P mode
Focus mode	Autofocus
Flash mode	Auto-on (if-raised)
Exposure compensation	± 0
Film-drive mode	Single-frame advance
Self-timer	Canceled
Wireless/Remote Flash	Canceled

- Red-eye reduction, manual film speed setting, and AF illuminator settings will not change.

ACCESSORY INFORMATION

This camera is designed to work specifically with lenses, flash units, and other accessories manufactured and distributed by Minolta. We therefore caution that using incompatible accessories with this camera may result in unsatisfactory performance or damage to the camera and accessories.

LENSES

- All Minolta AF lenses can be used with this camera.
- Manual focus lenses (MD or MC) cannot be attached to this camera.
- See page 52 for lens shadowing when using the built-in flash.

Optional Lens Kit (35-70mm f/3.5-4.5)

Lens specifications	Construction:	7 element, 7 groups
	Zoom angle	63 - 34 degrees
	Min. focus distance:	0.5m
	Max. magnification:	0.15X (70mm, 0.5m)
	Aperture:	Min: 22-32, Max: 3.5-4.5
	Filter diameter:	49mm
	Dimensions:	68.5 x 63mm
	Weight:	210g

Specifications are based on the latest information available at the time of printing and are subject to change without notice.

Optional lens hood

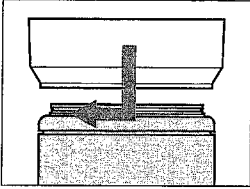

Fit the hood into the bayonet mount on the end of the lens barrel and turn the hood clockwise until it stops.

FLASHES

- All Minolta i-, xi-, and HS-Series flash units can be used with this camera.
 - See the flash instruction manual for the flash range.
 - Red-eye reduction is not available with accessory flash units.
- To use an AF-Series flash unit, Flash Shoe Adapter FS-1100 must be attached to the camera. When the flash is on, the flash will fire each time you take a picture. At no time will the flash's AF illuminator activate.
- X-Series flash units cannot be used.

OTHER ACCESSORIES

The following accessories cannot be used with this camera:

- Angle Finder
- Magnifier
- Control Grip CG-1100
- Data Receiver DR-1000
- Wireless Controller IR-1N

TROUBLE SHOOTING

CAMERA SHAKE WARNINGS

When the shutter speed display or flash-on indicator blinks, refer to this table to determine the possible cause.

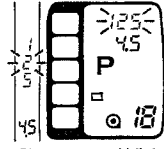
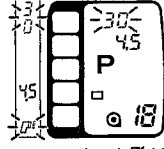
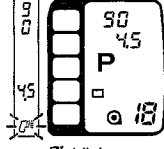
Mode	Display	Meaning	Solution
P / A	 <p>Shutter speed blinks</p>	Shutter speed is too slow for the focal length of the lens you are using; camera shake will effect the picture.	Use a tripod or steady the camera.
P	 <p>Shutter speed and AF blinks</p>	Light level requires flash; camera shake will effect the picture.	Use flash or tripod, or steady the camera.
P	 <p>AF blinks</p>	Subject is back-lit and flash is required.	Use flash.

- When subject program mode is set, these warnings are the same as those of P mode.

When the shutter speed and/or aperture display blink, or exposure-compensation indicator blinks, refer to this table to determine the possible cause.

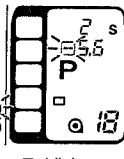
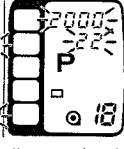
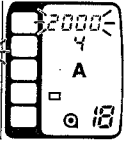
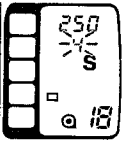
Mode	Display	Cause	Action
P/ A/ S/ M	 Exposure compensation indicator blinks	Scene or subject brightness is beyond the camera's metering range.	In bright light, attach a neutral density (ND) filter, use film with a lower film speed, or reduce the overall brightness of your surroundings. In low light, select M mode and use a hand-held meter, use film with a higher film speed, or increase the brightness of your surroundings (i.e., use flash).
P	 Shutter speed and aperture blink	Light level is beyond the range of available shutter speeds and apertures.	
A	 2000 or 30s blinks	Required shutter speed is beyond the range of the camera.	Select a larger/smaller aperture until the display stops blinking.
S	 Max or min aperture blinks	Required aperture is beyond the range of the lens.	Select a faster/slower shutter speed until the display stops blinking.

TROUBLE SHOOTING

Refer to this table to determine the cause of a problem you are experiencing with your camera. If the information does not cover the problem which you are experiencing or the condition continues, contact your nearest Minolta Service Facility.

PROBLEM	CAUSE	SOLUTION	PAGE
No display in the data panel when the camera is switched ON	<ul style="list-style-type: none">• Battery is exhausted	<ul style="list-style-type: none">• Install a new battery	16
Autofocus does not work when shutter-release button pressed partway down	<ul style="list-style-type: none">• Situation unsuitable for autofocus	<ul style="list-style-type: none">• Use focus lock or manual focus	47, 48
	<ul style="list-style-type: none">• Camera in manual focus	<ul style="list-style-type: none">• Set autofocus mode	48
	<ul style="list-style-type: none">• Subject too close	<ul style="list-style-type: none">• Check minimum focus distance for your lens	—
Shutter cannot be released	<ul style="list-style-type: none">• Focus cannot be confirmed	<ul style="list-style-type: none">• Use focus lock or manual focus	47, 48
	<ul style="list-style-type: none">• Camera is attached to telescope	<ul style="list-style-type: none">• Contact a Minolta Service Facility for information	—
Flash fires when shutter-release button is pressed partway down	<ul style="list-style-type: none">• AF illuminator is on	<ul style="list-style-type: none">• Normal camera operation	49

PROBLEM	CAUSE	SOLUTION	PAGE
Entire picture blurred	• Camera movement	• Hold camera steady and release shutter gently	19
	• Flash down in low light	• Use flash	51
	• Low speed film used	• Use film with a higher film speed	—
Flash picture too dark	• Subject beyond flash range	• Make sure subject is within flash range	52
	• Flash not charged	• Wait until ⚡ appears	24
Lower part of flash picture is dark	• Lens hood attached	• Remove lens hood	52
	• Lens is not suitable for use with built-in flash	• Use accessory flash	52
"HELP" appears in the data panel	• Camera operation malfunction	• Remove and reinstall the battery	16

CARE AND STORAGE

CLEANING

- If the camera or lens barrel is dirty, wipe it gently with a soft, clean, dry cloth. If it comes in contact with sand, gently blow away loose particles - wiping may scratch the surface.
- To clean the lens surface, first brush away any dust or sand and if necessary moisten a lens tissue with lens cleaning fluid and gently wipe the lens in a circular fashion from the center.
- Never place lens-fluid directly on the lens.
- Never touch the interior of the camera, especially the shutter and mirror. Doing so may impair their alignment and movement. Dust on the mirror will not affect the picture quality.
- Never use compressed air to clean the camera's interior, it may cause damage to sensitive interior parts.
- Never use organic solvents to clean the camera.
- Never touch the lens surface with your fingers.

STORAGE

When storing your camera for extended periods of time, please follow these guidelines:

- Always attach the protective caps.
- Store in a cool, dry and well ventilated area away from dust and chemicals such as moth balls. For very long periods, place the camera and lens in an airtight container with a silica gel drying agent.
- Periodically release the camera's shutter to keep it operating properly.
- Before using after prolonged storage, always check the camera's operation to make sure that it is functioning properly.

BEFORE IMPORTANT EVENTS

- Always check camera operation carefully or take test photographs.
- Minolta is not responsible for damages incurred by equipment malfunction.

QUESTIONS AND SERVICE

- If you have questions about your camera, contact your local camera dealer or write to the Minolta distributor in your area.
- Before shipping your camera for repair, please contact an authorized Minolta Service Facility for details.

TECHNICAL DETAILS

Type: 35mm single-lens-reflex (SLR) camera with micro-processor control of autofocus (AF) and autoexposure (AE)

Lens Mount: Minolta A-type bayonet mount

AF System: Minolta's through-the-lens (TTL) phase-detection system with one CCD line sensor; Continuous AF/focus lock selected automatically according to subject movement; Predictive and manual focus control with electronic confirmation; Sensitivity: EV -1 to 18 (ISO 100)

AF Illuminator: Built-in flash type; automatically activated in low-light/low-contrast conditions; Range: 1 - 5 m (3.3-16ft.)

Metering: Through-the-lens (TTL), 8-segment honeycomb pattern silicon photocell (SPC); Second SPC for TTL flash metering; Metering range: EV 1 to 20 (ISO 100, f/1.4 lens); Spot metering range: EV 4 to 20; Spot metering dimensions: 5.5mm diameter

Shutter: Electronically controlled, vertical traverse focal-plane type; Range: 1/2000 - 30 sec.; Flash sync speed: 1/90 sec. (1/45 when wireless / remote flash control is set)

Built-In Flash: Built-in, retractable with TTL control; Guide number: 12 in meters at ISO 100; Coverage for 28mm focal length; Recycling Time: approx. 2 sec.; Red-eye reduction pre-flash available; When flash is up, it fires automatically in low-light / backlit (P, Portrait, Landscape), fires automatically in low light (Close-up, Sports), always fires (Night portrait, A, S, M); When flash is down it does not fire.

Viewfinder: Roof mirror type; Field of view: 90%; Magnification: 0.75X (with 50mm lens at infinity); -1 diopter

Film Transport: Automatic advance to first frame; Single-frame advance; Continuous advance up to 1 frames/sec.; Automatic rewind; Manual start of automatic rewind possible

Film Speed Setting: Automatic setting for DX-coded films ISO 25 to 5000; Manual setting from ISO 6 to 6400 in 1/3 stop increments; Non-DX-coded film is set to the previous film speed; ISO 25 to 1000 is recommended for flash pictures

Battery: One 6-volt 2CR5 lithium battery; One 3-volt CR2025 lithium battery for Quartz Data Back model

Battery Performance (approximately):

<u>Flash Use</u>	<u>20°C (68°F)</u>	<u>-20°C (-4°F)</u>
0%	45 rolls	15 rolls
50%	20 rolls	10 rolls
100%	13 rolls	5 rolls

- Based on the following test conditions: 24 exposure roll of film; fresh battery; AF 35-70mm f/3.5-4.5 lens; autofocus from infinity to minimum focus distance and back 3 times; shutter-release button held partway down for 10 seconds before shutter release.
- Battery performance with a 36 exposure roll is reduced by approximately 1/3.
- If more operations are performed during use, battery performance will be slightly lower. To maximize battery performance, slide the main switch to LOCK when you are not using the camera.

Dimensions: 147(W) x 92.5(H) x 66.5(D)mm (5-13/16 x 3-5/8 x 2-5/8 in.);

Date model: 147 x 92.5 x 67.5mm (5-13/16 x 3-5/8 x 2-11/16 in.)

Weight: 400g (14-1/8 oz.); Date model: 405g (14-5/16 oz.) (without batteries)

Specifications and accessories are based on the latest information available at the time of printing and are subject to change without notice.

QUICK REFERENCE GUIDE

Set Full-Auto modo

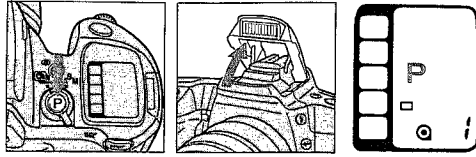

Fire flash manually in Full-Auto mode

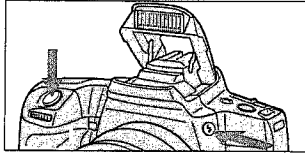

Select a Subject Program mode

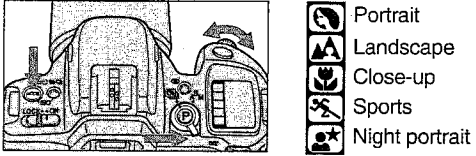

Photograph night portrait

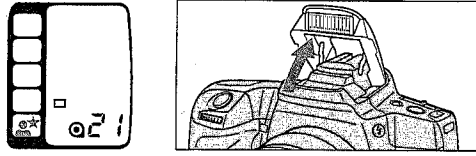

Photograph night scene

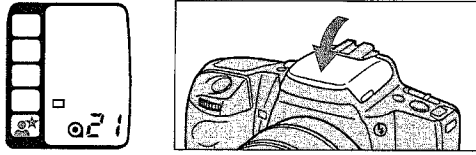

Select self-timer / Continuous drive / Double exposure

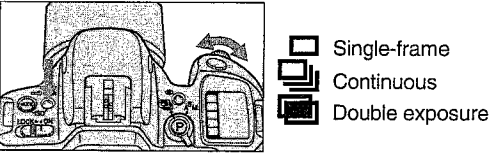

DYNAX 500si SUPER

Set A/S/M mode

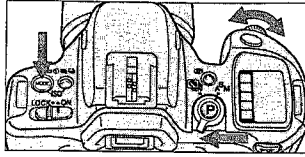

Fire flash in A/S/M mode

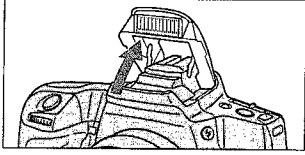

Select shutter speed / aperture in M mode

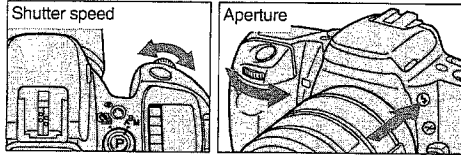

Set exposure compensation

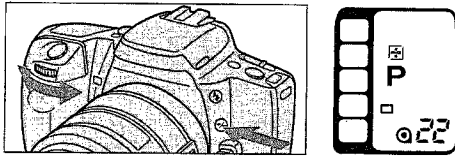

Reduce red-eye effect in flash picture

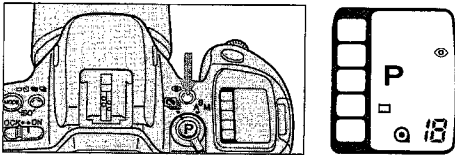

Start manual rewind

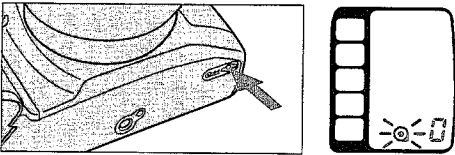

This device complies with Part 15 of the FCC Rules. Operation is subject to the following two conditions: (1) This device may not cause harmful interference, and (2) this device must accept any interference received, including interference that may cause undesired operation. Changes or modifications not approved by the party responsible for compliance could void the user's authority to operate the equipment. This equipment has been tested and found to comply with the limits for a Class B digital device, pursuant to Part 15 of the FCC Rules. These limits are designed to provide reasonable protection against harmful interference in a residential installation. This equipment generates, uses and can radiate radio frequency energy and, if not installed and used in accordance with the instructions, may cause harmful interference to radio communications. However, there is no guarantee that interference will not occur in a particular installation. If this equipment does cause harmful interference to radio or television reception, which can be determined by turning the equipment off and on, the user is encouraged to try to correct the interference by one or more of the following measures:

- Reorient or relocate the receiving antenna.
- Increase the separation between the equipment and the receiver.
- Connect the equipment to an outlet on a circuit different from that to which the receiver is connected.
- Consult the dealer or an experienced radio/TV technician for help.

This Class B digital apparatus meets all requirements of the Canadian Interference-Causing Equipment Regulations.

Minolta Co., Ltd.	3-13, 2-Chome, Azuchi-Machi, Chuo-Ku, Osaka 541, Japan
Minolta GmbH	Kurt-Fischer-Strasse 50, D-22923 Ahrensburg, Germany
Minolta France S.A.	365 Route de Saint-Germain, F-78420 Carrières-Sur-Seine, France
Minolta (UK) Limited	Rooksley Park, Precedent Drive, Rooksley, Milton Keynes, MK13 8HF, England
Minolta Austria Ges. m.b.H.	Amalienstrasse 59-61, A-1131 Wien, Austria
Minolta Camera Benelux B.V.	Zonnebaan 39, P.O. Box 6000, NL-3600 HA Maarssen, The Netherlands
Belgium Branch	Kontichsesteenweg 38, B-2630 Aartselaar, Belgium
Minolta (Schweiz) AG	Riedstrasse 6 CH-8953 Dietikon, Switzerland
Minolta Svenska AB	P.O. Box 9058, Albygatan 114, S-17109 Solna, Sweden
Finland Branch	Niittykatu 6 PL 37 SF-02201 Espoo, Finland
Minolta Portugal Limitada	Rua Afonso Lopes Vieira 55-B P-1700 Lisboa, Portugal
Minolta Corporation	
Head Office	101 Williams Drive, Ramsey, New Jersey 07446, U.S.A.
Los Angeles Branch	11150 Hope Street Cypress, CA 90630, U.S.A.
Minolta Canada Inc.	
Head Office	369 Britannia Road East, Mississauga, Ontario L4Z 2H5, Canada
Vancouver Branch	106-3850 Jacombs Road, Richmond, B.C. V6V 1Y6, Canada
Minolta Hong Kong Limited	Room 208, 2/F, Eastern Center, 1065 King's Road, Quarry Bay, Hong Kong
Minolta Singapore (Pte) Ltd.	10, Teban Gardens Crescent, Singapore 608923
Shanghai Minolta Optical Products Co., Ltd.	368 Minolta Road, Songjiang, Shanghai, China

© 1995 Minolta Co., Ltd. under the Berne Convention
and Universal Copyright Convention

9222-2151-31

Printed in Malaysia