

JVC



COMPACT DISC PLAYER

XL-V130BK/XL-V230BK

XL-V130BK

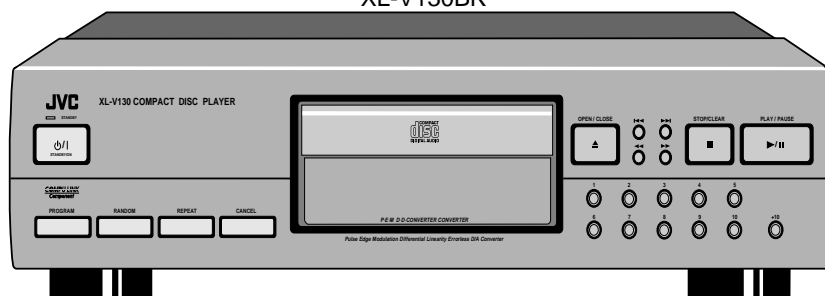

XL-V230BK

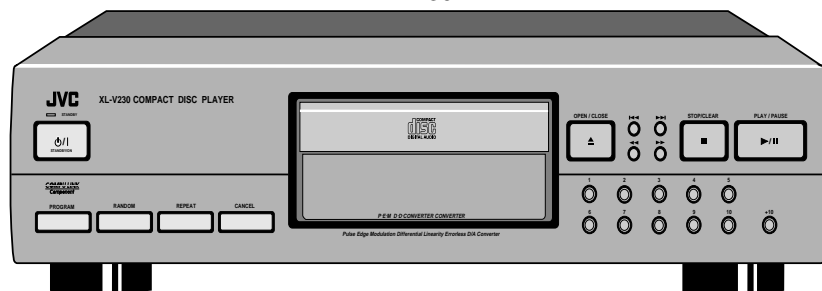
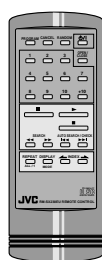

COMPACT
disc
DIGITAL AUDIO

COMPU LINK
Component

INSTRUCTIONS

For Customer Use:

Enter below the Model No. and Serial No. which are located either on the rear, bottom or side of the cabinet. Retain this information for future reference.

Model No. _____

Serial No. _____

Warnings, Cautions and Others

IMPORTANT for the U.K.

DO NOT cut off the mains plug from this equipment. If the plug fitted is not suitable for the power points in your home or the cable is too short to reach a power point, then obtain an appropriate safety approved extension lead or consult your dealer.

BE SURE to replace the fuse only with an identical approved type, as originally fitted.

If nonetheless the mains plug is cut off ensure to remove the fuse and dispose of the plug immediately, to avoid a possible shock hazard by inadvertent connection to the mains supply.

If this product is not supplied fitted with a mains plug then follow the instructions given below:

IMPORTANT.

DO NOT make any connection to the terminal which is marked with the letter E or by the safety earth symbol or coloured green or green-and-yellow.

The wires in the mains lead on this product are coloured in accordance with the following code:

Blue : Neutral
Brown : Live

As these colours may not correspond with the coloured markings identifying the terminals in your plug proceed as follows:

The wire which is coloured blue must be connected to the terminal which is marked with the letter N or coloured black.

The wire which is coloured brown must be connected to the terminal which is marked with the letter L or coloured red.

IF IN DOUBT - CONSULT A COMPETENT ELECTRICIAN.

Caution — POWER switch!

Disconnect the mains plug to shut the power off completely. The POWER switch in any position does not disconnect the mains line. The power can be remote controlled for XL-V230BK.

CAUTION

To reduce the risk of electrical shocks, fire, etc.:

1. Do not remove screws, covers or cabinet.
2. Do not expose this appliance to rain or moisture.

IMPORTANT FOR LASER PRODUCTS

REPRODUCTION OF LABELS

- ① CLASSIFICATION LABEL, PLACED ON REAR ENCLOSURE

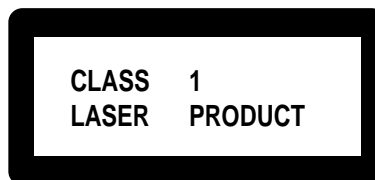

- ② WARNING LABEL, PLACED INSIDE THE UNIT

DANGER: Invisible laser radiation when open and interlock failed or defeated. AVOID DIRECT EXPOSURE TO BEAM. (e)	VARNING: Osynlig laserstrålning när denna del är öppnad och spärren är urkopplad. Betrakta ej strålen. (s)	ADVARSEL: Usynlig laserstrålning ved åbning, når sikkerhedsafbrydere er ude af funktion. Undgå udsættelse for stråling (d)	VARO: Avattaessa ja suojalukitus ohitettaessa olet alttiina näkymättömälle lasersäteilylle. Älä katso säteeseen. (f)
---	---	---	---

1. CLASS 1 LASER PRODUCT
2. **DANGER:** Invisible laser radiation when open and interlock failed or defeated. Avoid direct exposure to beam.
3. **CAUTION:** Do not open the top cover. There are no user serviceable parts inside the Unit; leave all servicing to qualified service personnel.

We would like to thank you for purchasing one of our JVC products.

Before connecting this unit to the wall outlet, please read the instructions carefully to ensure that you obtain the best possible performance.

If you have any questions, please consult your JVC dealer.

Table of contents

INTRODUCTION	1
Precautions	1
About this manual	1
Names of buttons	2
BEFORE USING FOR THE FIRST TIME	4
Installing the unit	4
Connecting to other equipments	4
Supplying the power	5
To connect the AC power cord of the main unit	5
Installing the batteries	6
To install the batteries in the remote control unit	6
COMPU LINK connection	6
BASIC OPERATIONS	7
Basic functions for disc playback	7
Turning on the power of this unit	7
Loading a disc in the disc tray	7
Remote control operation	7
Playing a disc	8
Stopping playback	8
Locating a point to start playback	8
Skipping to a desired track	8
Skipping to a desired index	8
Searching for a desired section	9
Specifying a desired track	9
Displaying the time	9
Switching the time display on XL-V230BK	9
Displaying the time on XL-V130BK	9
VARIOUS PLAYBACK PATTERNS	10
Playing tracks in a desired order	10
Playing tracks in a random order	10
Playing repeatedly	11
Repeating whole disc	11
Repeating one track	11
GENERAL INFORMATIONS	12
COMPU LINK remote control system	12
Care and handling	13
Troubleshooting	14
Specifications	15

INTRODUCTION

Precautions

Load compact disc only

Never insert anything other than a compact disc into any part of the player.

If a problem persists

If something goes wrong, turn off the power immediately. If the same problem reoccurs when the power is turned on once more, turn off the power again and consult your JVC dealer.

Handling the power cord

When unplugging from the wall socket, always pull the plug body, never the power cable.

Volume settings

A CD player has almost zero background noise. Because of this, the technique of listening to the background level and then setting the volume before the music starts, as used with analog turntables or tape decks, cannot be used. If you raise the volume level too high, speaker damage may result.

Condensation

The CD player uses optical components. If it is moved from a cold location to a warm one, or is used in a room subject to excessive humidity or where a fire has just been lit, condensation could form on the optical components.

This may prevent the laser beam from being properly transmitted and thus causes noise or even a malfunction.

If condensation has formed and the CD player does not function correctly, we recommend that you leave it turned on for an hour or two. If at the end of this time the CD player still does not function properly, please consult your JVC dealer.

Transporting the unit

When carrying this unit, it is best to avoid either tilting it or turning it upside-down. Where you cannot avoid doing so, please remove the disc first.

Using compact discs

Compact discs are made of plastic and can be easily damaged. If the disc is dirty, scratched, warped or otherwise damaged, the digital information may not be picked up correctly.

Applicable discs

This unit can only be used with compact discs bearing the mark below. Never use discs of other types.



About this manual

This manual covers the operating instructions for the compact disc player XL-V130BK and XL-V230BK.

There are several functions which require separate instructions for each model. Please check the model number stated on the carton box, and follow the descriptions applicable to your unit.

This manual is organized as follows:

The first part, "INTRODUCTION", gives you the precautions when using this unit, and shows you the names of buttons on the main unit and the remote control unit.

The second part, "BEFORE USING FOR THE FIRST TIME", tells you what kind of operations you should do before playing a disc. This part describes where to place the unit for best results, how to install batteries in the remote control unit and how to connect this unit to the amplifier/receiver and other components.

The third part, "BASIC OPERATIONS", describes how to load a disc, and convenient basic functions for playing disc.

The fourth part, "VARIOUS PLAYBACK PATTERNS", describes various functions for playing disc, and convenient functions for recording.

The fifth part, "GENERAL INFORMATIONS", describes the COMPU LINK remote control system which facilitates various operations between JVC components, and explains how to take care of discs.

This part also includes "Troubleshooting" which tells you how to check the unit when a malfunction occurs, and the technical informations regarding this unit.

Names of buttons

Main unit

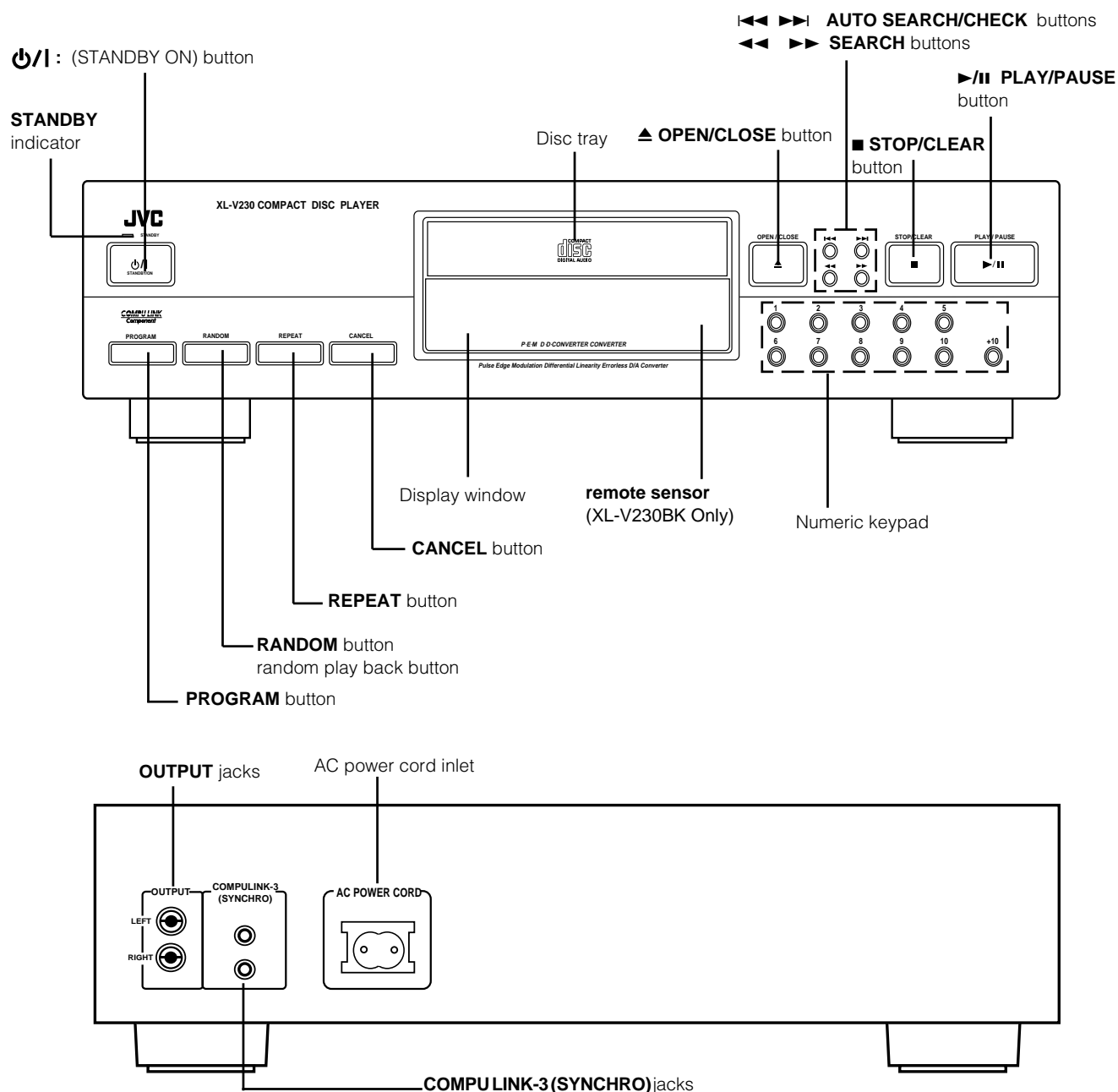

Remote control unit (XL-V230BK only)

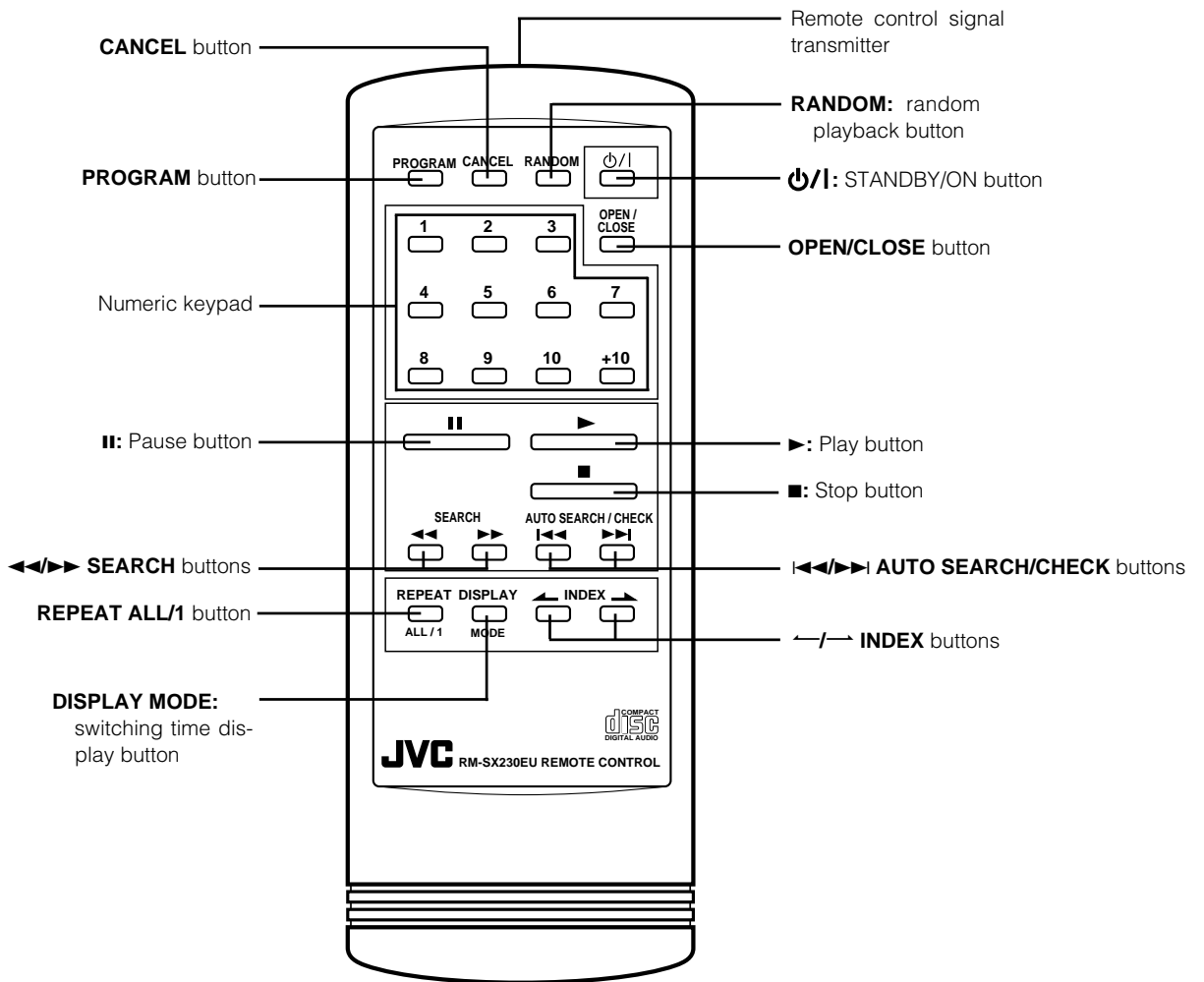

BEFORE USING FOR THE FIRST TIME

Installing the unit

Best location

Select a location which is level, dry and neither too cold nor too hot (temperature range 5°C (41°F) to 35°C (95°F)). Also, avoid dusty locations or any location subject to vibration.

If interference occurs

If this equipment is placed near a tuner or a radio receiver tuned to AM frequencies, interference may occur. If this happens, we recommend either that you move this unit as far away as possible from the tuner or receiver or briefly turn off the power to this unit.

Connecting to other equipments

Connecting to an amplifier or receiver allows you to listen to the sound from the speakers.

Connect the OUTPUT jacks of this unit to the line input jacks of an amplifier or receiver with the supplied audio cord.

Notes

- *Never connect the OUTPUT jacks to the PHONO jacks of the amplifier or receiver. This may cause damage to the components.*
- *Make sure that the same channels are connected between this unit and the amplifier or receiver: LEFT to LEFT and RIGHT to RIGHT.*
- *Do not connect the power plug until all connections are complete.*
- *Connect the plugs firmly. Loose connections may cause noise or malfunction.*

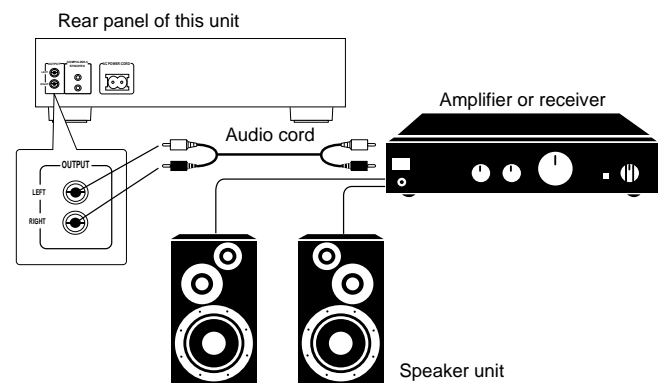

Supplying the power

To connect the AC power cord of the main unit

The AC power cord is supplied separately and must be connected to the unit.
Plug the AC power cord into the AC POWER CORD inlet of this unit and connect to the wall outlet after all connections are complete.

Note

When using the COMPU LINK Remote Control System, do not connect the power cord to the SWITCHED AC OUTLET of an amplifier or receiver.

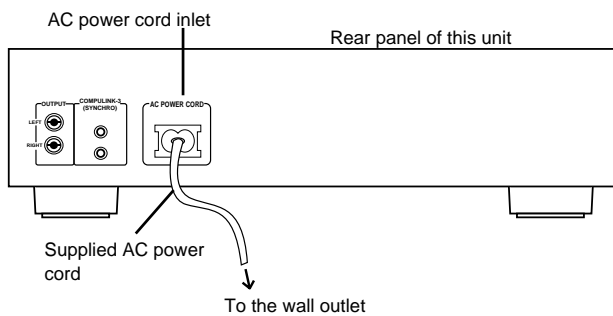

Installing the batteries

(XL-V230BK Only)

To install the batteries in the remote control unit

Before operating the remote control unit, install two batteries.

1. Remove the rear cover of the remote control unit by pressing down and simultaneously pulling it backwards.

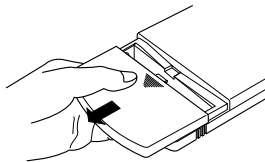

2. Install batteries. Be sure that the batteries are installed with correct polarity, (+) and (-).

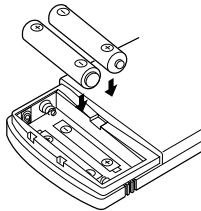

3. Attach the rear cover by sliding it back into position.

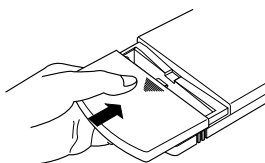

Notes

Incorrect use of batteries can cause corrosion or damage. Note the following points to lengthen battery life.

- Install batteries observing the correct polarity, (+) and (-).
- Do not use new and old batteries simultaneously.
- Batteries with similar shapes may have different voltage ratings. Be sure to use the correct batteries.
- Remove batteries from the remote control unit if it will not be used for a long period of time.
- Do not expose batteries to heat or flame.

Battery replacement

Service life of batteries depends on the condition of use; standard life is about one year. When the batteries become weak, the operating distance of the remote control unit becomes short. If this happens, replace the batteries R03(UM-4)/AAA(24F) with new ones.

Note

- The lower the temperature, the shorter the battery life.

COMPU LINK connection

JVC's COMPU LINK Remote Control System provides unified control over system components connected with COMPU LINK. Connecting JVC audio components with the COMPU LINK jacks automatically controls relative operations between components and facilitates various operations. With the COMPU LINK connection to an amplifier or receiver, you can operate XL-V130BK/XL-V230BK with the amplifier or receiver's remote control unit. Synchronized recording is also available with this feature.

Connecting the COMPU LINK cord

The COMPU LINK-3 SYNCHRO jacks are used to output and input the control signal for the COMPU LINK remote control system.

COMPU LINK-compatible products are provided with the jacks marked COMPU LINK-1, COMPU LINK-2 or COMPU LINK-3, referring to the COMPU LINK version. XL-V130BK/XL-V230BK is equipped with COMPU LINK-3. You can connect XL-V130BK/XL-V230BK also to a component with a lower COMPU LINK versions. But, in that case, only the lower versions' features will be available.

Plug the supplied COMPU LINK cord into the COMPU LINK-3 SYNCHRO jack on the rear panel of XL-V130BK/XL-V230BK. Plug the other end into the COMPU LINK jack of the other component. If there are two COMPU LINK jacks, plug it into either of them.

Connecting the COMPU LINK system components with the COMPU LINK cords

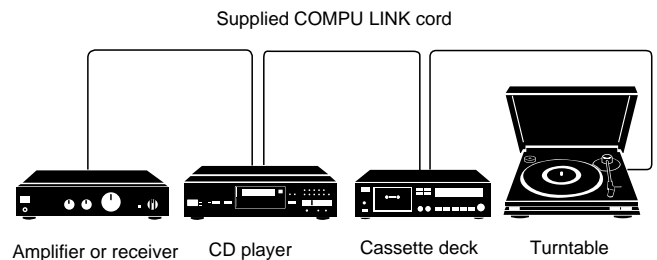

BASIC OPERATIONS

Basic functions for disc playback

Turning on the power of this unit

Press the $\phi/|$ (STANDBY/ON) button to turn on this unit. The STANDBY indicator is turned off and the display is turned on.

Remote control unit
(XL-V230BK ONLY)

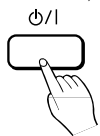

Main unit

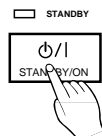

Press again to turn the power off and activate the standby mode. The STANDBY indicator is lit.

The power is automatically turned on also by;

- Pressing the \blacktriangle OPEN/CLOSE button.
- Pressing the \blacktriangleright button on the remote control unit or the $\blacktriangleright/||$ PLAY/PAUSE button on the main unit.

Notes

- A small amount of power (4 watts) is consumed even in the standby mode.
- To turn the power off completely, disconnect the power cord from the wall outlet.

Loading a disc in the disc tray

Use the \blacktriangle OPEN/CLOSE button to open and close the disc tray.

Remote control unit
(XL-V230BK ONLY)

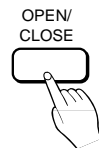

Main unit

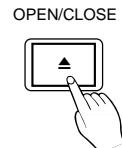

1. Open the disc tray by pressing the \blacktriangle OPEN/CLOSE button.
2. Place a disc on the disc tray according to the groove with its label side up.
3. Close the disc tray by pressing the \blacktriangle OPEN/CLOSE button.

Note

- When loading a disc in the disc tray, be sure to put the disc according to the groove. Otherwise, the disc will be damaged when the disc tray is closed, and the disc cannot be removed from the unit.

Good

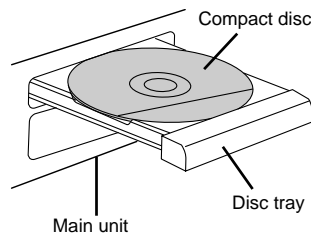

No Good

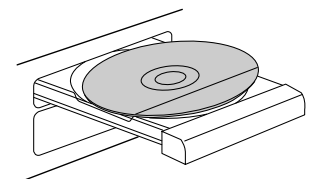

Remote control operation (XL-V230BK Only)

Point the remote control unit towards the remote sensor and operate it steadily and carefully. The remote control unit can be used within a range of about 7 meters (23 feet) from the remote sensor, and at angles of up to about 30 degrees.

Locating a point to start playback

Skipping to a desired track

Use the ◀◀/▶▶ buttons.

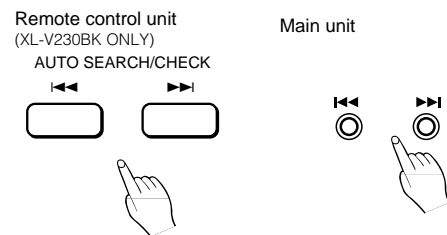

To skip back to the beginning of the track being played, tap the ◀◀ button. When the beginning of the track is reached, tapping this button again skips to the previous track. To skip to the next track, tap the ▶▶ button. When using the ◀◀ ▶▶ buttons on the main unit, tap them until the desired track appears.

Skipping to a desired index (XL-V230BK Only) (for a disc with INDEX)

Use the ←/→ INDEX buttons.

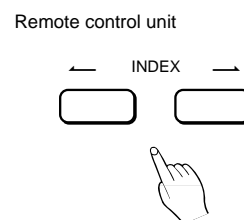

To skip back to the beginning of the index being played, tap the ← INDEX button. When the beginning of the index is reached, tapping this button again skips to the previous index. To skip to the next index, tap the → INDEX button.

Playing a disc

Press the ▶ button on the remote control unit or the ▶/|| PLAY/PAUSE button on the main unit.

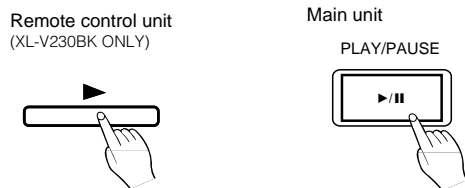

The ▶ indicator lights on the display and playback starts. When no disc is loaded in the unit, the disc tray opens.

To stop playback temporarily, press the || button on the remote control unit or the ▶/|| PLAY/PAUSE button on the main unit. The || indicator lights on the display and playback stops temporarily. To resume playback, press the ▶ button on the remote control unit or the ▶/|| PLAY/PAUSE button on the main unit.

Stopping playback

Press the ■ button.

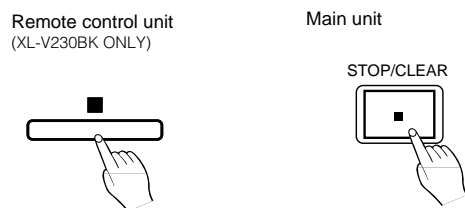

Searching for a desired section

Keep the ◀▶/▶▶ SEARCH buttons on the remote control unit or the ◀▶/▶▶ SEARCH buttons on the main unit pressed during playback.

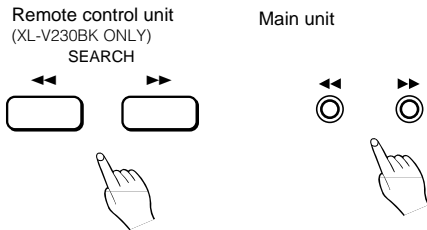

Playback advances or reverses rapidly. While the ◀◀ button is kept pressed, playback rapidly reverses toward the beginning of the track. While the ▶▶ button is kept pressed, playback rapidly advances toward the end of the track. When the desired section is reached, release the button. The player resumes normal playback from that point.

Note
Two speeds are available for fast forward and fast backward. Pressing and holding the button provides the faster speed.

Specifying a desired track

To specify the desired track number, use the numeric keypad (1-10, +10).

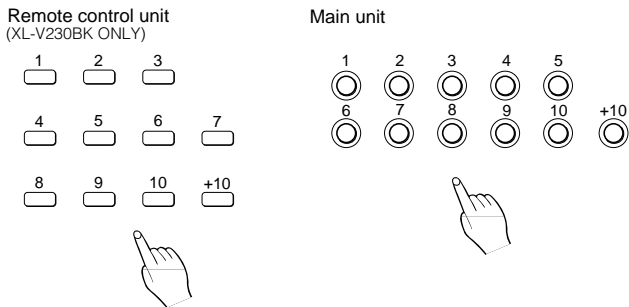

The unit searches for the selected track and playback starts automatically. When selecting track number 10 or less, press the corresponding numeric button. When selecting track number 11 or above, use the [+10] button. Example: To select track number 12, press [+10] and then [2]. To select track number 25, press [+10] twice and then [5]. To select track number 30, press [+10] twice and then [10].

Note
The track number which does not exist on the selected disc, cannot be selected.

Displaying the time

Switching the time display on XL-V230BK

Each time the DISPLAY MODE button is pressed, the time display changes as the following.

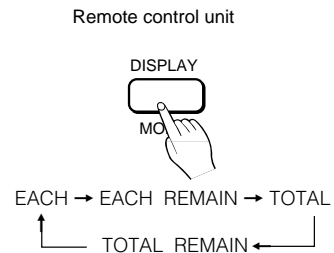

The corresponding indicator lights in each time mode.
EACH: Shows the elapsed time of the track being played.
EACH REMAIN: Shows the remaining playback time of the track being played.
TOTAL: Shows the total playing time of the disc being played.
TOTAL REMAIN: Shows the remaining playback time of the disc being played.

Displaying the time on XL-V130BK

The XL-V130BK has the following time displays.

EACH: Shows the elapsed time of the track being played.
EACH REMAIN: Shows the remaining playback time of the track being played.
TOTAL: Shows the total playing time of the disc being played.

VARIOUS PLAYBACK PATTERNS

Playing tracks in a desired order

You can play only the favorite tracks in any desired order.

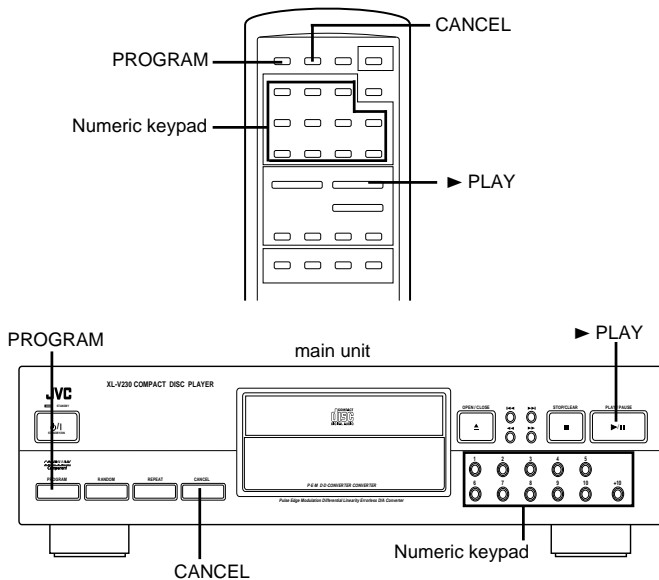

1. In stop mode, press the PROGRAM button so that "PRGM" lights on the display.

2. Select the track number with the numeric keypad.

Refer to "Specifying a desired track" on page 9 for entering the track number.

The selected track number is programmed and the following display appears.

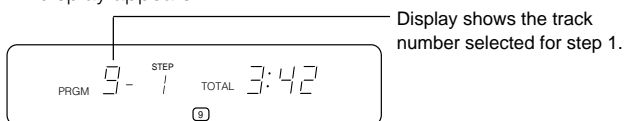

• If you want to cancel the displayed program step, press the CANCEL button and then enter the new track number.

3. Repeat step 2 for other tracks to be programmed.

You can program up to 32 tracks.

4. Start playback by pressing the ► button.

The programmed tracks are played in the programmed order.

- You can skip to a desired program step with the ◀◀ or ▶▶ button.
- You can add tracks in the program during the playback.

To check the program contents

Press the ◀◀ or ▶▶ button during stop mode. Each time the ◀◀ or ▶▶ button is pressed, the program contents are displayed in the programmed order or the reverse order.

To clear the entire program

In stop mode, press the ■ STOP/CLEAR button on the main unit. The program contents will be cleared, however, the program mode is not cancelled.

To exit program mode

Press the PROGRAM button again, and the program mode is cancelled.

Playing tracks in a random order

You can select and play tracks in a random order. Selections are made so that each track in the disc is played only once.

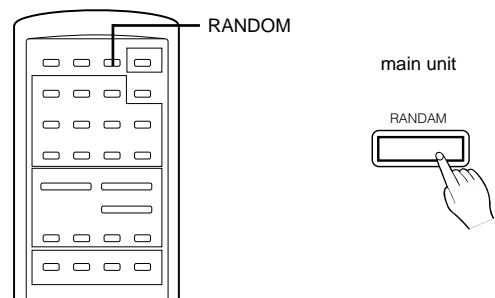

1. Press the RANDOM button so that the "RANDOM" indicator lights on the display.

- To skip to the track to be played next, press the ►| button.

To exit random playback

Press the stop button, and the random mode is cancelled.

Playing repeatedly

You can repeatedly play the whole disc or one track.
It is also possible to utilize this function in combination with random/program playback function.

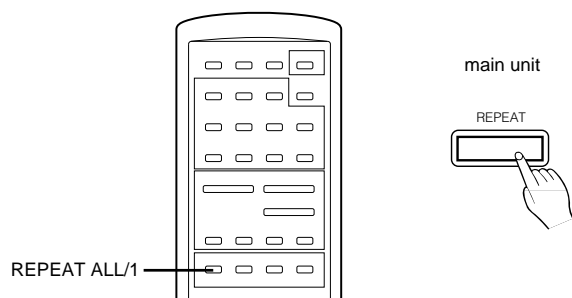

Repeating whole disc

Press the **REPEAT (ALL/1)** button so that the **REPEAT** indicator lights on the display.

All tracks are played repeatedly.

Repeating one track

Press the **REPEAT (ALL/1)** button so that the **REPEAT 1** indicator lights on the display.

The displayed track is played repeatedly.

To cancel repeat mode

Press the **REPEAT (ALL/1)** button so that the **REPEAT** and **REPEAT 1** indicators go out.

GENERAL INFORMATIONS

COMPU LINK remote control system

The COMPU LINK Remote Control System controls relative operations between components automatically and facilitates various operations.

This is a system originated and developed by JVC for facilitating various system operations.

The following is a brief explanation of this system:

Automatic source selection

When the supplied COMPU LINK cord is utilized to connect this unit to others equipped with COMPU LINK jacks, switching-in of each system component can be performed with a single touch on the source selector button located on a JVC amplifier or receiver.

When selection is carried out in this manner, the corresponding unit will automatically start operation.

Upon pressing of the play button, the source selector of the amplifier or receiver changes automatically. When a new unit is switched in, the previously selected component stops operation within five seconds.

Synchronized recording

Synchronized recording refers to the process in which a JVC cassette deck starts recording, synchronized with this unit. Synchronized recording is carried out as follows:

1. Set the cassette deck to the recording pause mode in accordance with its instructions.
2. To record only certain tracks, program the tracks in any order, as desired.
3. Press the ►/|| PLAY/PAUSE button on the front panel of this unit. The cassette deck automatically starts recording, synchronized with this unit.

Notes

- Synchronized recording stops automatically when this unit stops playback.
- To cancel synchronized recording, press the ■STOP button of this unit or the cassette deck.
- To properly operate the synchronized recording, the buttons/controls other than POWER, ■ STOP and OPEN do not function.
- If the recording pause mode is set on the cassette deck by pressing the || PAUSE button after pressing the ● REC and ► PLAY buttons simultaneously, synchronized recording is not possible. For details, refer to the instructions for the cassette deck.

Automatic power on/off function

This function is to control the power on/off of the receiver/amplifier or this unit respectively as the following.

- When this unit enters playback mode, the power of the receiver or amplifier is turned on.
- When the source selector of the receiver/amplifier is set to CD function mode, the power of this unit is turned on.

Notes

- Abnormal operation may result if the power supply of the component(s) is interrupted. If this happens, you must start over again.
- Ensure that the COMPU LINK jacks of the each component are connected with the supplied COMPU LINK cord. Also, be sure to fully read the instructions for each component.
- When the power of the amplifier or receiver is switched off, this unit is also turned off automatically.

Care and handling

How to handle CDs

When handling compact discs, do not touch the surface of the disc (reflective silver side - the side without the label).

Since compact discs are made of plastic, they are easily damaged. If the disc gets dirty, dusty, scratched or warped, the sound will not be picked up correctly and, in addition, such discs may cause the CD player to malfunction.

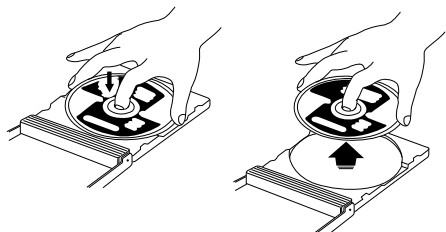

Maintenance of discs

When there are fingerprints or other dirt adhering to a disc, wipe the disc with a soft, dry cloth with a movement going from the inside outwards.

If difficult to clean, wipe the disc with a cloth moistened with water. Never use record cleaners, petrol, alcohol or any anti-static agents.

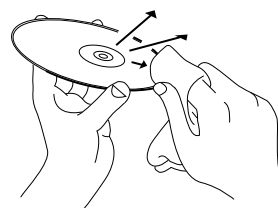

Even on label side

Do not damage the label side, stick paper to or use any adhesive on this surface.

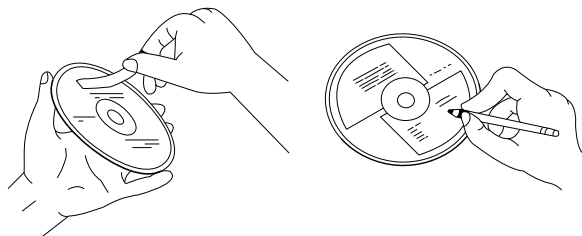

Storage

Make sure that discs are kept in their cases. If discs are piled one on top of another without their protective cases, they can be damaged.

Do not put discs in any location where they can be exposed to direct sunlight - or in any place where humidity or temperature is high. Avoid leaving discs in your car!

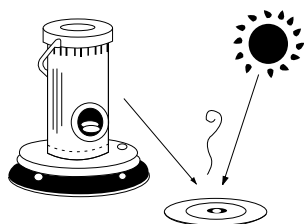

Troubleshooting

What appears to be a malfunction may not always be serious. Please go through the following list before requesting service.

Symptom	Possible cause	Remedy
The unit is not operative.	Power plug is disconnected from the AC outlet.	Connect the plug to an AC outlet.
	The AC power cord plug is disconnected from the AC power cord inlet of this unit.	Connect the plug to an AC power cord inlet.
	Disc is not loaded.	Load a disc in the disc tray.
The remote control unit does not function. (XL-V230BK only)	Batteries are exhausted.	Replace both batteries.
	There is an obstacle between remote control unit and the remote sensor of the main unit.	Remove the obstacle.
	Direct sunlight shines on the remote sensor of the main unit.	Shade the unit from the direct sunlight.
Playback is not possible.	Disc is inserted upside down.	Load a disc with its label-side up in the disc tray.
	Disc is not loaded in the correct position.	Load the disc according to the groove of the disc tray.
	Moisture is condensed inside the unit.	Leave the unit turned on until the moisture evaporates.
The reproduced sound includes noise.	Disc is dirty.	Wipe off the disc surface with a soft cloth.
	Disc is warped.	Replace the disc with a new one.
The sound is intermittent.	Disc is scratched.	Replace the disc with a new one.



Specifications

General

System:	Compact disc player
Signal detection system:	Non-contact optical system
Sampling frequency:	44.1 kHz
Power requirements:	AC 230 V [~] , 50Hz
Power consumption:	10watts (POWER ON) 4 watts (STANDBY)
Dimensions (W x H x D):	435 x 101 x 281 mm
Mass:	3.3 kg

Audio performance

Frequency response:	2 Hz to 20,000 Hz (±1 dB)
Dynamic range:	More than 98 dB (at 1 kHz)
Signal to noise ratio:	More than 106 dB
Total harmonic distortion:	Less than 0.0025% (at 1 kHz)
Channel separation:	More than 94 dB (at 1 kHz)
Wow and flutter:	Less than measurable limit
Output level	2.0Vrms (at 10 kohms)

Accessories

Remote control unit (RM-SX230EU)(XL-V230BK only)	1
Battery R03(UM-4)/AAA(24F) (XL-V230BK only)	2
Audio cord	1
COMPU LINK cord	1
AC POWER cord	1

Design and specifications subject to change without notice.

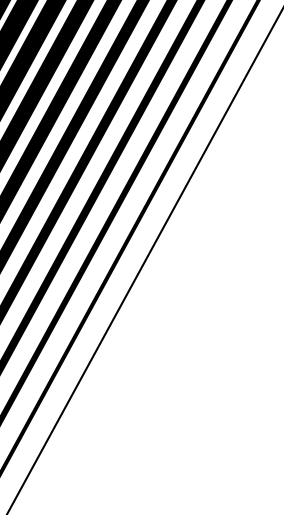

VICTOR COMPANY OF JAPAN, LIMITED