

# JVC



## CD PORTABLE SYSTEM

SISTEMA PORTÁTIL CON REPRODUCTOR DE CDs

# RC-EX20S/RC-EX20A/ RC-EX20B

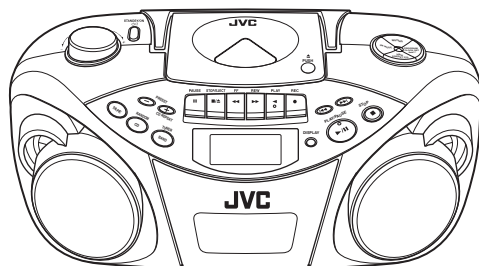

COMPACT  
**disc**  
DIGITAL AUDIO

## INSTRUCTIONS

MANUAL DE INSTRUCCIONES

### For Customer Use:

Enter below the Model No. and Serial No. which are located on the rear of the cabinet. Retain this information for future reference.

Model No. \_\_\_\_\_

Serial No. \_\_\_\_\_

LVT1225-001A

[J]

## Warnings, Cautions and Others

### Avisos, precauciones y otras notas

---

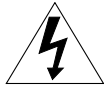

The lightning flash with arrowhead symbol, within an equilateral triangle is intended to alert the user to the presence of uninsulated "dangerous voltage" within the product's enclosure that may be of sufficient magnitude to constitute a risk of electric shock to persons.



The exclamation point within an equilateral triangle is intended to alert the user to the presence of important operating and maintenance (servicing) instructions in the literature accompanying the appliance.

#### For U.S.A.

This equipment has been tested and found to comply with the limits for a Class B digital device, pursuant to part 15 of the FCC Rules.

These limits are designed to provide reasonable protection against harmful interference in a residential installation.

This equipment generates, uses and can radiate radio frequency energy and, if not installed and used in accordance with the instructions, may cause harmful interference to radio communications. However, there is no guarantee that interference will not occur in a particular installation. If this equipment does cause harmful interference to radio or television reception, which can be determined by turning the equipment off and on, the user is encouraged to try to correct the interference by one or more of the following measures:

Reorient or relocate the receiving antenna.

Increase the separation between the equipment and receiver.

Connect the equipment into an outlet on a circuit different from that to which the receiver is connected.

Consult the dealer or an experienced radio/TV technician for help.

**WARNING: TO REDUCE THE RISK OF FIRE OR ELECTRIC SHOCK, DO NOT EXPOSE THIS APPLIANCE TO RAIN OR MOISTURE.**

### CAUTION

To reduce the risk of electrical shocks, fire, etc.:

1. Do not remove screws, covers or cabinet.
2. Do not expose this appliance to rain or moisture.

### PRECAUCIÓN

Para reducir posibles riesgos de descargas eléctricas, incendios, etc, le recomendamos que:

1. No quite los tornillos, cubiertas ni el gabinete.
2. No deje expuesto este aparato a la lluvia ni a la humedad.

#### Caution — STANDBY/ON button!

Disconnect the mains plug to shut the power off completely. The STANDBY/ON button in any position does not disconnect the mains line.

#### Precaución — Interruptor STANDBY/ON!

Desconectar el cable de alimentación para desactivar la alimentación totalmente. Cualquier que sea la posición de ajuste del interruptor STANDBY/ON, la alimentación no es cortada completamente.

### IMPORTANT FOR LASER PRODUCTS

1. CLASS 1 LASER PRODUCT
2. **CAUTION:** Do not open the top cover. There are no user serviceable parts inside the unit; leave all servicing to qualified service personnel.
3. **CAUTION:** Visible and invisible laser radiation when open and interlock failed or defeated. Avoid direct exposure to beam.
4. **REPRODUCTION OF LABEL:** CAUTION LABEL, PLACED INSIDE THE UNIT.

### IMPORTANTE PARA PRODUCTOS LÁSER

1. PRODUCTO LÁSER CLASE 1
2. **PRECAUCIÓN:** No abra la tapa superior. En el interior de la unidad no hay piezas que pueda reparar el usuario; encargue el servicio a personal técnico cualificado.
3. **PRECAUCIÓN:** Radiación láser visible e invisible en caso de apertura o con interbloqueo averiado o defectuoso. Evite la exposición directa a los haces.
4. **REPRODUCCIÓN DE LA ETIQUETA:** ETIQUETA DE PRECAUCIÓN, COLOCADA EN EL INTERIOR DE LA UNIDAD.

**CAUTION -** INVISIBLE LASER RADIATION WHEN OPEN AND INTERLOCKS DEFEATED. AVOID EXPOSURE TO BEAM.

**VORSICHT !** UNSICHTBARE LASERSTRAHLUNG TRITT AUS, WENN DECKEL GEÖFFNET UND WENN SICHERHEITSVERRIEGELUNG ÜBERBRÜCKT IST. NICHT DEM STRAHL AUSSETZEN!

**WARNING -** OSYNLIG LASERSTRÅLNING NÅR DENNA DEL ÄR ÖPPNAD OCH SPÄRR ÄR URKOPPLAD STRÅLEN ÄR FARLIG.

**ADVARSEL -** USYNLIG LASERSTRÅLING VED ÅBNING NÅR SIKKERHEDSAFBRYDERE ER UDE AF FUNKTION. UNDGÅ UDSÆTTELSE FOR STRÅLING.

## CONTENTS

FEATURES .....	1	PLAYING COMPACT DISCS .....	8
SAFETY PRECAUTIONS .....	1	RADIO RECEPTION .....	12
HANDLING PRECAUTIONS .....	2	CASSETTE PLAYBACK .....	14
POWER SUPPLY .....	3	RECORDING .....	16
NAMES OF PARTS AND CONTROLS .....	4	MAINTENANCE .....	18
TURNING THE UNIT ON/OFF .....	5	TROUBLESHOOTING .....	19
SETTING THE CLOCK .....	6	SPECIFICATIONS .....	20
ADJUSTING THE SOUND .....	7		

## FEATURES

- |   |  |
|---|--|
| <b>1 Portable system incorporating CD player</b><br>8-cm (3-3/16") CD playback capability | <b>3 Synchronized recording with CD playback</b> |
| <b>2 Digital LCD (Liquid Crystal Display) indicates general playback status.</b>          | <b>4 Hyper-Bass Sound effect</b>                 |

## SAFETY PRECAUTIONS

### Prevention of Electric Shocks, Fire Hazards and Damages

- Even when the STANDBY/ON button is set to STANDBY, a very small current will flow. When the unit is turned on, the display window lights in orange. When the unit is in standby mode, the display window turns off. (Note, however, that the display window does not light even when the unit is turned on if the unit is operated on batteries.) To save power and for safety when not using the unit for an extended period of time, disconnect the power cord from the household AC outlet.
- Do not handle the power cord with wet hands.
- When unplugging from the wall outlet, always grasp and pull the plug, not the power cord.
- Consult your nearest dealer when damage, disconnection, or contact failure is found with the cord.
- Do not bend the cord sharply, or pull or twist it.
- Rating label is placed on the exterior of the bottom.
- Do not modify the power cord in any manner.
- Do not remove screws to disassemble the unit and do not touch anything inside the unit to avoid accidents.
- Do not insert any metallic objects into the unit.
- Unplug the power cord when there is a possibility of lightning.
- If water gets inside the unit, unplug the power cord from the outlet and consult your dealer.
- Do not block the ventilation holes of the unit so that heat can escape.
- Do not install the unit in a badly ventilated place.

## HANDLING PRECAUTIONS

Do not use this unit in direct sunlight or leave the unit in a closed automobile (or yacht, etc.) where it would be exposed to high temperatures above 40°C (104°F).

### 1 Avoid using the unit in the following places:

- Where the temperature may become excessively high or low; the recommended temperature range is 5°C (41°F) and 35°C (95°F).
- Where it could be subject to vibrations.
- Where it is excessively humid, such as in a bathroom.
- Where it could be magnetized by a magnet or speaker.

### 2 Pay attention to dust.

Be sure to close the disc door so that the lens is not contaminated by dust. Do not touch the lens.

### 3 Condensation

Condensation may occur in the following cases, in which the unit may not operate correctly:

- The unit is in a room where a heater has just been switched on.
- The unit is in a place where there is smoke or high humidity.
- The unit has just moved from a cold place to a warm room.

In these cases, set the STANDBY/ON button to ON and wait one or two hours before use.

### 4 Volume control

Compact discs produce very little noise compared with analog records. If you adjust the volume by listening to the noise as you do with analog records, the speakers could be damaged by a sudden blast of sound when playback starts. Therefore, turn down the volume before starting and adjust it as required while playing a CD.

### 5 Safety mechanism

The unit incorporates a safety interlock mechanism which switches off the laser beam when the disc door is opened.

### 6 Do not place magnetic objects such as cassette tapes near the speakers.

Since the speakers contain magnets inside, do not place cassette tapes or magnetic cards nearby as recorded data could be erased.

### 7 Keep the unit away from the TV.

When the unit is used near a TV, the TV picture could be distorted. If this happens, move the unit away from the TV. If this does not correct the situation, avoid using the unit when the TV is turned on.

### 8 Cleaning the cabinet

If the cabinet gets dirty, wipe it with a soft, dry cloth. Never use benzine or thinner as these could damage the surface finish.

### 9 When listening with headphones

- Do not listen at high volumes as it could damage your hearing.
- For safety, do not drive while listening with headphones.

### 10 Carrying handle

Do not raise or lower the carrying handle with the telescopic antenna extended, to avoid damaging the antenna. Position the carrying handle so that it does not interfere with operation.

## POWER SUPPLY

### Operation on household AC

The AC power cord provided with this unit has one-way connections to prevent electric shock. Refer to the figure below for correct connection.

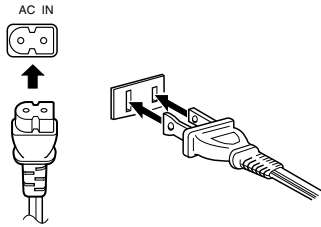

#### CAUTIONS:

- Use only with the JVC power cord provided with this unit to avoid malfunction or damage to the unit. Remove batteries when using the power cord.
- Be sure to unplug the power cord from the outlet when going out or when the unit is not in use for an extended period of time.

### Operation on batteries

#### Loading batteries

##### 1 Open the battery cover.

Pull the battery cover toward you while pressing the sections marked by the arrows.

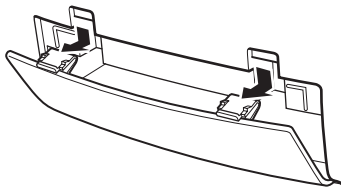

##### 2 Insert six R20 (SUM-1)/D (13D)-size batteries.

Be sure to insert the batteries with the  $\oplus$  and  $\ominus$  terminals positioned correctly.

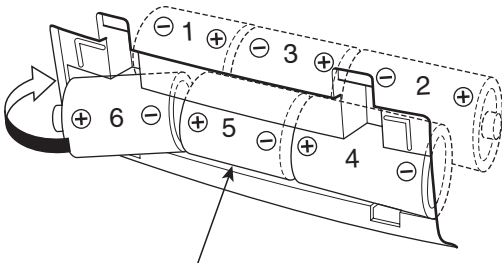

R20 (SUM-1)/D (13D)-size batteries

##### 3 Replace the cover.

### Checking batteries

When the tape speed or output sound level decreases, or CD playback becomes intermittent, replace all batteries with fresh ones.

When making an important recording, use new batteries (preferably alkaline batteries with a longer service life) to avoid any possible failure.

### For better battery usage

- Continuous operation of the unit causes the battery power to be consumed quicker than noncontinuous operation.
- Operation of the unit in a cold place causes the battery power to be consumed more quickly than in a warm place.

#### CAUTIONS:

- When not using the unit for a long time (more than two weeks) or when using the household AC, remove the batteries to avoid a malfunction or damage to the unit.
- When the JVC power cord provided with this unit is connected, the power is automatically switched from the batteries to the household AC even when the batteries are loaded. However, remove the batteries when using the power cord.

#### CAUTIONS WHEN USING BATTERIES:

When batteries are used incorrectly, it may result in the leakage of chemicals from the batteries or they may explode. The following care should be taken:

- Check that the positive  $\oplus$  and negative  $\ominus$  terminals of the batteries are positioned correctly and load them as shown in the figure on the left.
- Do not mix new and old batteries together, or mix different types of batteries.
- Do not try to recharge non-rechargeable batteries.
- Remove the batteries when the unit is not to be used for an extended period of time.

If chemicals from the batteries come in contact with your skin, wash them off immediately with water. If chemicals leak onto the unit, clean the unit completely.

## NAMES OF PARTS AND CONTROLS

### Top and front sides

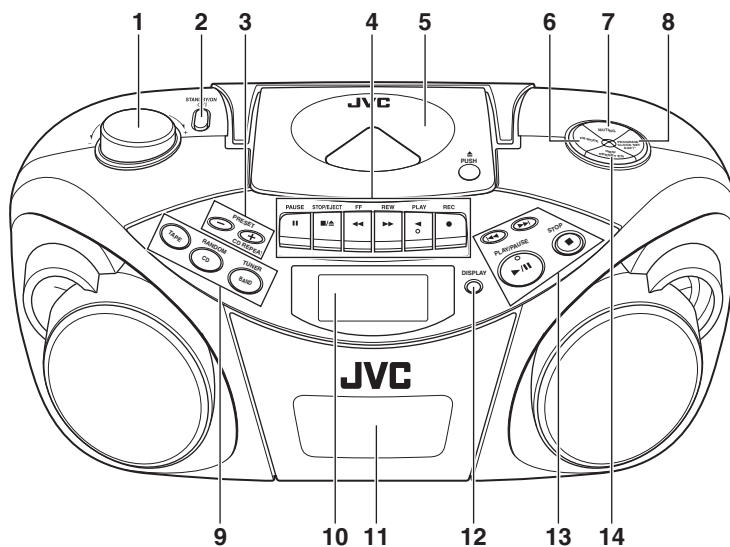

- |  |  |
|--|--|
| 1 VOLUME knob  | 7 MUTING button  |
| 2 STANDBY/ON $\text{O}/\text{I}$ button  | 8 PROGRAM/CLOCK SET button   |
| 3 PRESET - button<br>PRESET + / CD REPEAT button   | 9 TAPE button<br>CD/RANDOM button<br>BAND/TUNER button   |
| 4 Tape operation buttons<br>PAUSE $\text{II}$ button<br>STOP/EJECT $\blacksquare/\blacktriangle$ button<br>FF $\lll$ button<br>REW $\ggg$ button<br>PLAY $\blacktriangleleft$ button<br>REC $\bullet$ button | 10 Display window<br>11 Cassette deck<br>12 DISPLAY button<br>13 $\lll$ button<br>$\ggg$ button<br>PLAY/PAUSE $\blacktriangleright/\text{II}$ button<br>STOP $\blacksquare$ button |
| 5 Disc door  | 14 HBS/PRESET EQ button  |
| 6 FM MODE button   |  |

## Rear side

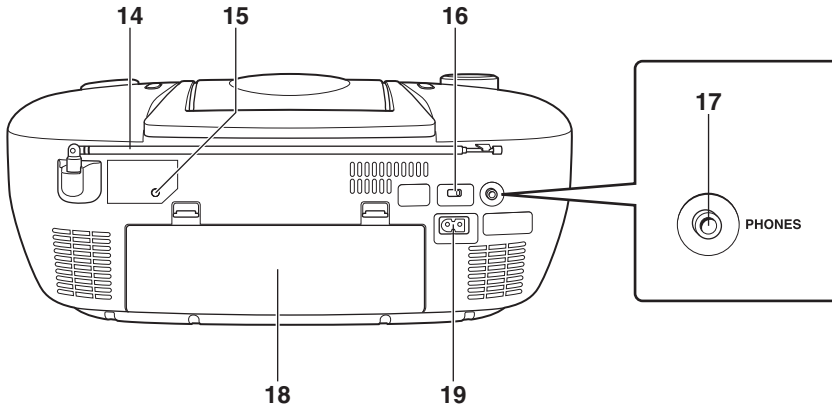

**14 Telescopic antenna**

**15 RESET button**

**16 BEAT CUT switch**

**17 PHONES jack**

Connect stereo mini headphones (3.5-mm (3/16") diameters, impedance of 16  $\Omega$  to 32  $\Omega$ ) to this jack. The speaker output is switched off with headphones connected.

**18 Battery compartment cover**

**19  $\sim$ AC IN (AC input) jack**

## TURNING THE UNIT ON/OFF

STANDBY/ON  $\phi$ /I

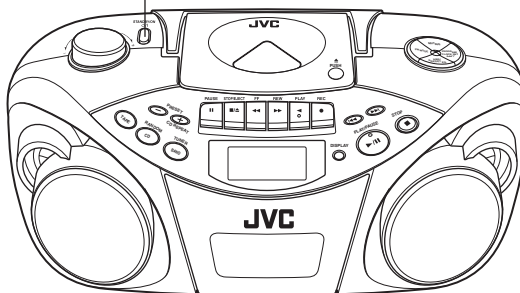

**STANDBY/ON  $\phi$ /I button**

**Press the STANDBY/ON  $\phi$ /I button on the unit to turn on and off the unit.**

The display window lights up when the unit is turned on. (Note, however, that the display window does not light even when the unit is turned on if the unit is operated on batteries.) The unit comes on ready to play the source selected when the unit was last turned off.

**To switch off the power supply completely**

Unplug the AC power cord from the AC outlet. If the batteries are inserted in the unit, take them out.

**Notes:**

- When you unplug the AC power cord or if a power failure occurs, the clock is reset to "AM 12:00" right away, while the tuner preset stations (see page 13) will be erased in a few days. The clock indication will keep flashing until you set the clock again.
- Remove the batteries when carrying the unit by hand or in the trunk of a car. This prevents the power from being accidentally turned on, thus avoiding wasteful battery consumption.



## SETTING THE CLOCK

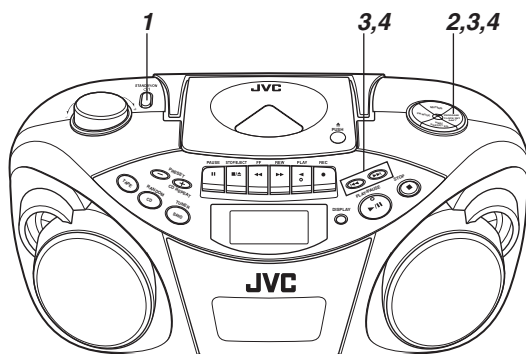

Before operating the unit any further, first set the clock built in this unit.

The clock uses 12-hour indication. "AM 12:00" indicates midnight, and "PM 12:00" indicates noon.

**1 Press STANDBY/ON  $\odot$ /I to turn off the unit, if it is turned on.**

The clock flashes on the display window.

**2 Press and hold PROGRAM/CLOCK SET for more than 2 seconds.**

The hour digits start flashing.



**3 Press  $\lll$  or  $\ggg$  to adjust the hour, then press PROGRAM/CLOCK SET.**

The minute digits start flashing.



**4 Press  $\lll$  or  $\ggg$  to adjust the minutes, then press PROGRAM/CLOCK SET.**

### Note:

If there is a power failure, the clock loses the setting and is reset to "AM 12:00." The clock indication will keep flashing until you set the clock again.

### To show the clock when CD or tuner is selected

Press DISPLAY.

Each time you press the button, the display changes the clock indication and the normal indication alternately. (Operating the unit while clock indication is displayed changes the display to the normal indication.)



## ADJUSTING THE SOUND

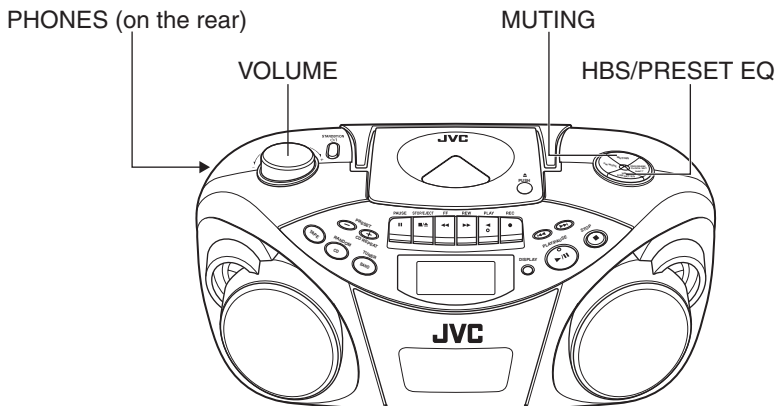

### Adjusting the volume

Turn **VOLUME** clockwise to increase the volume or counterclockwise to decrease it.

The volume level can be adjusted in 31 steps (00 VOL to 30 VOL).



#### Caution:

DO NOT turn off the unit with the volume set to an extremely high level; otherwise a sudden blast of sound could damage your hearing and/or the speakers and headphones, when you turn on the unit or start playing another source next time.

REMEMBER you cannot adjust the volume unless the unit is turned on.

### Turning off the sound temporarily

During playback, press **MUTING**.

The sound is turned off and the **MUTING** indicator appears in the display window.

To restore the sound, press **MUTING** again.

### Listening through headphones

Connect a pair of headphones to the **PHONES** jack. No sound comes out of the speakers anymore. Be sure to turn down the volume before connecting headphones.

### Reinforcing the bass sound

You can enjoy powerful bass sound with the Hyper-Bass Sound effect.

Press and hold **HBS/PRESET EQ** so that the **HBS** indicator lights up in the display window.

To turn off the effect, press and hold the button again so that the HBS indicator goes off.

### Selecting the sound mode

You can select one of the 5 preset sound modes.

**CLASSIC**: Good for classical music.

**ROCK** : Boosts low and high frequency. Good for acoustic music.

**POP** : Good for vocal music.

**JAZZ** : Good for jazz music.

**FLAT** : Normal sound.

#### To select the sound mode

Press **HBS/PRESET EQ** repeatedly until the indicator for the sound mode you want appears in the display window.

Each time you press the button, the sound mode changes as follows:

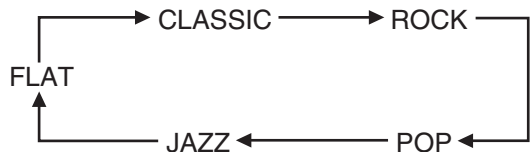

## PLAYING COMPACT DISCS

### Notes on compact discs

This unit has been designed only to play back the following CDs.

- Digital audio CD
- Recordable digital audio CD (CD-R)
- Rewritable digital audio CD (CD-RW)



### When playing a CD-R or CD-RW

You can play back **finalized CD-R or CD-RW** recorded in **music CD format**. (If a CD-RW has been recorded in a different format, erase all the data on the CD-RW completely before recording on it.)

- You can play back CD-R or CD-RW like an audio CD.
- Some CD-R or CD-RW may not be played back on this unit because of their disc characteristics, damage or stain on them, or if the player lens is dirty.
- The reflection factor of CD-RW is lower than that of other CDs, possibly causing CD-RW to take longer time to read.
- CD-R and CD-RW of MP3 format cannot be played back.

### Handling discs

Since dirty, damaged or warped discs could damage the unit, care should be taken of the following:

- Do not touch the reflective recorded surface.
- Do not stick or write anything on the label side.
- Do not bend discs.

### Storage

- After removing a disc from the unit, be sure to put it back in its case.
- Do not expose discs to direct sunlight, high temperatures from a heater, etc., high humidity or dust.

### Cleaning discs

Before loading a disc, wipe off any dust, dirt or fingerprints with a soft, dry cloth. Discs should be cleaned by wiping radially, from the center to edge.

Never use thinner, benzene, record cleaner or antistatic spray.

- Removing the disc from its storage case and replacing it

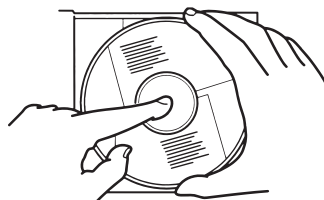

Press the center and lift out.

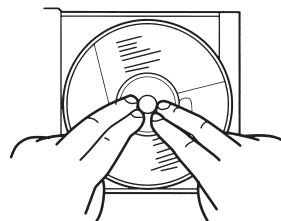

Press to secure the disc.

- Handling

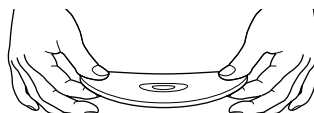

Incorrect

- Cleaning



Correct



Incorrect

## Basic operation

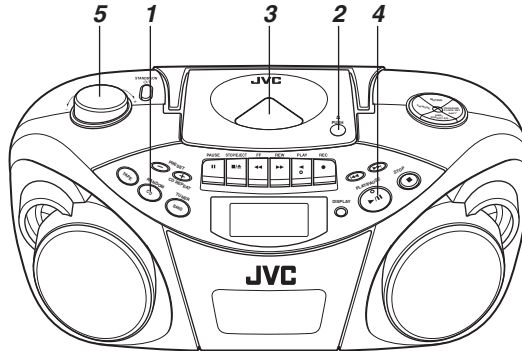

**1** Press **CD/RANDOM** to enter CD mode, if the unit is in **TUNER** or **TAPE** mode.

**2** Press  $\triangle$  **PUSH** to open the disc door.

**3** Load a disc with the label side facing up and close the disc door.

- 8-cm (3-3/16") CD can be played on the unit without an adapter.

**4** Press **PLAY/PAUSE**  $\blacktriangleright/\parallel$  to start playback.

The current track number and elapsed playing time are displayed during playback.



**5** Adjust the volume.

### Notes:

- The following indication may be displayed when the disc is loaded upside down. Reload the disc correctly.

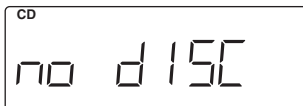

- If mistracking occurs during playback, lower the volume.
- Mistracking may occur if a strong shock is applied to the unit or if it is used in a place subject to vibrations (e.g. in a car travelling on a rough road).
- If you press **CD/RANDOM** while in CD mode, the unit enters the random playback mode.

### To stop playback

Press **STOP**  $\blacksquare$ .



### Caution:

Stop playback before opening the disc door. Check that the disc has completely stopped rotating before unloading the disc.

### To pause playback

Press **PLAY/PAUSE**  $\blacktriangleright/\parallel$  during playback.

To resume playback, press the button again.



## Skipping

- **To skip back to the previous track**

During playback, press **⏮** once to return to the beginning of the current track, press twice to skip back to the beginning of the previous track.

- **To skip to the next track**

During playback, press **⏭** to skip to the beginning of the next track.



## Search – locating a desired position on the disc

**Press and hold** **⏮** or **⏭** **during playback.**

Monitor the sound and release the button when the desired position is located.



## Repeat/Random playback

CD/RANDOM    PRESET+/CD REPEAT

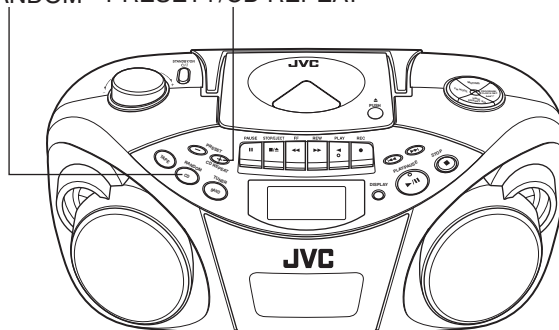

### Repeat playback

**Press PRESET + / CD REPEAT during playback.**

Each time you press the button, the repeat mode changes in the following order:

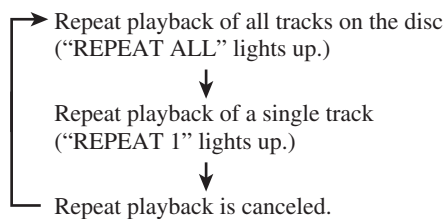

### Random playback

**Press CD/RANDOM in CD mode so that the RANDOM indicator lights up in the display window.**

Tracks are played in random order.

To cancel random playback, press the button again so that the RANDOM indicator goes off.

## Programmed playback

Up to 20 tracks can be programmed to play in any desired order.

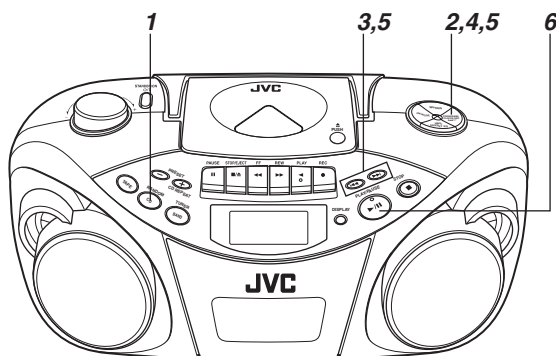

### Note:

There is a time limit in doing the following steps. If the setting is canceled before you finish, start from step 2 again.

- 1 Press CD/RANDOM to enter CD mode.
- 2 Press PROGRAM/CLOCK SET in stop mode.  
The PROG indicator starts blinking in the display window.

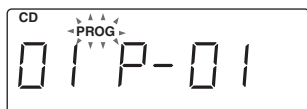

- 3 Press ◀◀ or ▶▶ to select a desired track to be programmed.

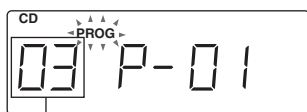

Track to be programmed

- 4 Press PROGRAM/CLOCK SET.
- 5 Repeat steps 3 and 4 to program other tracks.
- 6 Press PLAY/PAUSE ▶/|| while the PROG indicator blinks.  
The tracks are played in the order you have programmed.

### Notes:

- If the PROG indicator goes off before you press PLAY/PAUSE ▶/||, press PROGRAM/CLOCK SET, then start playback.
- If you press CD/RANDOM while in CD mode, the unit enters the random playback mode.

### To stop during playback

Press STOP ■.

The PROG indicator goes off and the unit exits from programmed playback.

### To check the program contents

Before starting programmed playback, press PROGRAM/CLOCK SET.

Each time you press the button, the programmed tracks are shown in the display window.

### To add tracks in the program

- 1 Press PROGRAM/CLOCK SET repeatedly so that "00" appears as the track number.
- 2 Press ◀◀ or ▶▶ to select the track number, then press PROGRAM/CLOCK SET.

### To edit the program

- 1 Press PROGRAM/CLOCK SET repeatedly so that the program number you want to edit is shown.
- 2 Press ◀◀ or ▶▶ to select a new track number, then press PROGRAM/CLOCK SET.

### To repeat programmed playback

Press PRESET + / CD REPEAT after starting programmed playback.

### To erase the entire program in the memory

Press PROGRAM/CLOCK SET so that the PROG indicator blinks, and press STOP ■ while the PROG indicator blinks.

The stored program is also cleared when the disc door is opened.

### Note:

After you have programmed 20 tracks, the program number returns to "1." Programming more tracks overwrite the tracks already programmed to those numbers.

## Tuning in a station

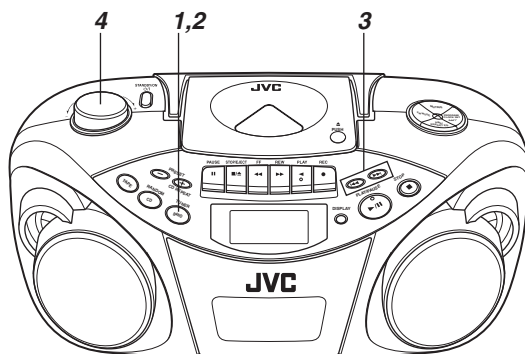

- 1 Press **BAND/TUNER** to enter the tuner mode.
- 2 Press **BAND/TUNER** to select the band, FM or AM.
- 3 Press and hold **◀◀** or **▶▶** for more than 1 second.  
The unit starts searching and stops when a station of sufficient signal strength is tuned in.  
If you press **◀◀** or **▶▶** briefly and repeatedly, the frequency changes step by step.
- 4 Adjust the volume.

### Changing the FM reception mode

When an FM stereo broadcast is hard to receive or noisy, reception improves in monaural reception.

Press **FM MODE** so that the **MONO** indicator appears in the display window.

To restore the stereo effect, press **FM MODE** again so that the **MONO** indicator goes off.



#### Note:

The FM reception mode setting will be canceled when you tune in another station.

### Using the antennas

#### FM

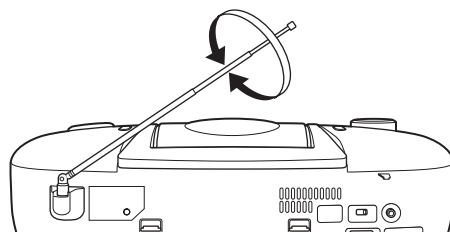

#### AM

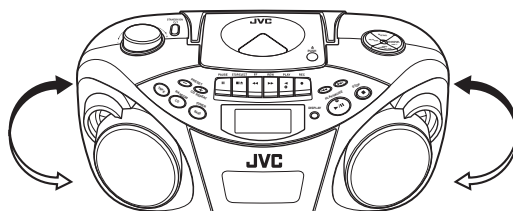

#### Note:

The built-in ferrite core antenna may pick up interference from television receivers in the neighborhood disturbing AM reception.

## Presetting stations

You can preset 10 FM and 10 AM stations.

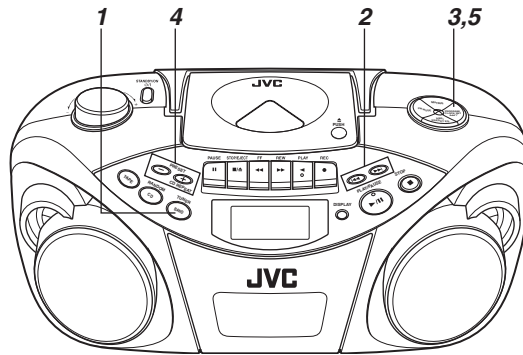

There is a time limit in doing the following steps. If the setting is canceled before you finish, start from step 3 again.

### Note:

In some cases, test frequencies have been already memorized for the tuner since the factory examined the tuner preset function before shipment. This is not a malfunction. You can preset the stations you want into memory by following the presetting method.

**1 Press BAND/TUNER to select the band, FM or AM.**

**2 Press**  $\lll$  **or**  $\ggg$  **to tune in the station you want to preset.**

**3 Press PROGRAM/CLOCK SET.**

The PROG indicator starts blinking in the display window.



**4 Press PRESET + / CD REPEAT or PRESET - to select the preset number.**

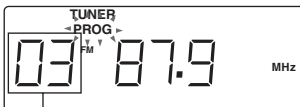

Preset number

**5 Press PROGRAM/CLOCK SET.**

The tuned station in step 2 is stored in the preset number selected in step 4.

Storing a new station on a used number erases the previously stored one.

**6 Repeat steps 2 to 5 to preset other stations, using different preset numbers.**

### Tuning in a preset station

**1 Press BAND/TUNER to select the band, FM or AM.**

**2 Press PRESET + / CD REPEAT or PRESET - repeatedly until the desired preset number appears.**

### Note:

If you unplug the AC power cord or if a power failure occurs, the preset stations will be erased in a few days. If this happens, preset the stations again.



## CASSETTE PLAYBACK

### Notes on cassette tapes

- Use only type-I normal tapes. The recording/playback characteristics of this unit are those for normal tapes, which have different characteristics from CrO<sub>2</sub> and metal tapes.
- The use of tapes longer than 120 minutes is not recommended, since characteristic deterioration may occur and these tapes easily jam in the pinch roller and the capstan.
- Loose tape may cause trouble. Gently tighten the tape with a pencil as shown in the figure below.

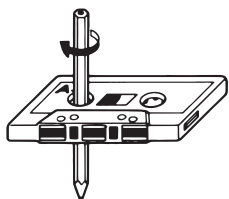

Turn the pencil to take up the slack.

- To prevent recordings from being accidentally erased, remove the tab(s) with a screwdriver. After the tabs have been broken off, reseal the slots with adhesive tape to erase or re-record.



### Loading a cassette

- 1 Press STOP/EJECT ■/▲ to open the cassette holder.**
- 2 Load a cassette with the open side up and the playback side facing out as shown in the figure below.**

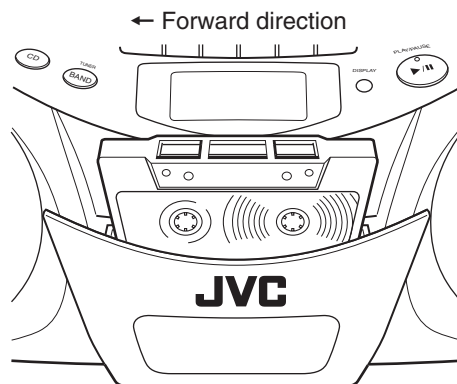

- 3 Close the cassette holder by pressing it gently and firmly.**

The cassette holder clicks back into position.

## Basic operation

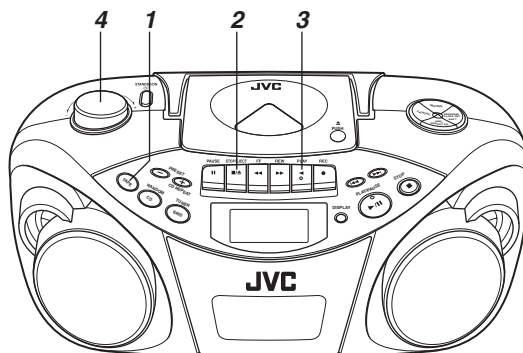

**1** Press **TAPE** to enter the tape mode.

**2** Load a cassette.

Use only a type-I normal tape.

**3** Press **PLAY** ◀ to start playback.

**4** Adjust the volume.

### Fast-winding a tape

Press **REW** ▶▶ or **FF** ◀◀.

When the tape reaches the end, press **STOP/EJECT** ■/▲ to release **REW** ▶▶ or **FF** ◀◀.

### To stop playback

Press **STOP/EJECT** ■/▲.

The tape also stops when it reaches the end.

# RECORDING

## Basic operation

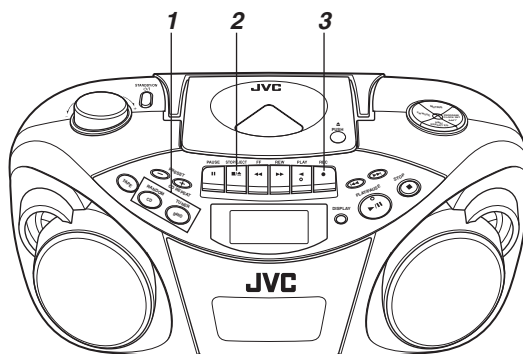

### Standard recording

#### 1 Prepare the recording source.

- When recording from the radio:  
Set to the tuner mode and tune in a desired station.
- When recording from a CD:  
Set to the CD mode and load a CD.

#### 2 Load a blank or erasable cassette.

Use only a type-I normal tape.

#### 3 Press REC ●.

PLAY ◀ is also depressed, and recording starts.

### To stop recording

Press STOP/EJECT ■/▲.

The tape also stops when it reaches the end.

### Notes:

- **It should be noted that it may be unlawful to re-record pre-recorded tapes, records, or discs without the consent of the owner of copyright in the sound or video recording, broadcast or cable program and in any literary, dramatic, musical, or artistic work embodied therein.**
- The recording level is automatically set correctly, so it is not affected by VOLUME. Thus, during recording you can adjust the sound you are actually listening to without affecting the recording level.
- If a recording you made has excessive noise or static, the unit may have been too close to a TV which was on during the recording. Either turn off the TV or increase the distance between the TV and the unit.

### Using the beat-cut function

When recording an AM broadcast, beats may occur. If this happens, change the BEAT CUT switch on the rear of the unit to either “1” or “2” to reduce the beating sound.



### To start recording at the exact moment

- 1 Press PAUSE || first, then press REC ●, thus entering the record-pause (standby) mode.
- 2 Press PAUSE || to release the tape at the exact moment you want to start recording.

### Note:

Do not leave the unit in pause mode for more than a few minutes. Instead, press STOP/EJECT ■/▲ to stop the tape.

## Synchronized recording with CD playback

You can make the CD player to start playback when the tape deck enters the recording mode.

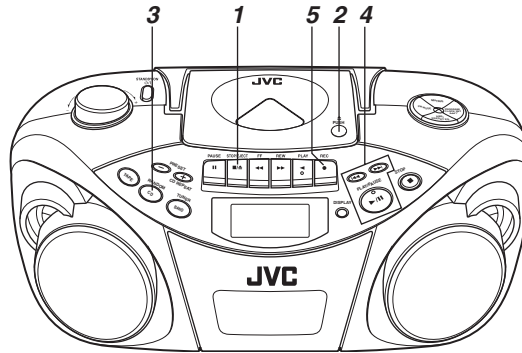

### 1 Load a cassette.

Use only a type-I normal tape.

### 2 Load a CD.

### 3 Press CD/RANDOM to enter CD mode.

### 4 Specify a track or point on the disc to start recording.

- To start recording from the desired track, select the track by pressing L◀◀ or ▶▶R in stop mode.
- To start recording from the desired point on a disc, play the disc and pause at the desired point by pressing PLAY/PAUSE ▶/||.

### 5 Press REC ●.

PLAY ◀ is also depressed, and synchronized recording starts.

- The CD SYNC indicator appears in the display window during synchronized recording.

When the tape reaches the end first, the CD player enters the pause mode. Press PLAY/PAUSE ▶/|| to continue playback, or press STOP ■ to stop playback.

When the CD player stops first, the tape continues running. In this case, press STOP/EJECT ■/▲ to stop the tape.

## Erasing

When recording on a pre-recorded tape, the previous recording is erased and only the new recording is heard next time the tape is played back.

### To erase a tape without making a new recording

1 Press TAPE on the unit to enter the tape mode.

2 Press REC ●.

## MAINTENANCE

### Cleaning the heads, capstan and pinch roller

#### Cleaning is important!

When the tape is running, magnetic powder and dust naturally accumulate on the heads, capstan and pinch roller. When they become too dirty;

- Sound quality deteriorates.
- The sound output level drops.
- The previous recording is not completely erased.
- Recording is not performed satisfactorily.

To avoid these, clean the heads, capstan and pinch roller every 10 hours of use.

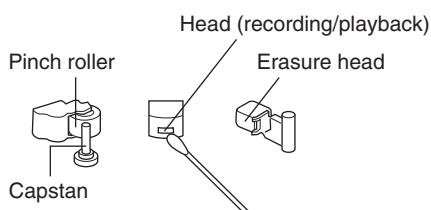

#### Open the cassette holder. Clean the heads, capstan and pinch roller.

For effective cleaning, use a cleaning kit available at an audio store.

After cleaning, make sure that the cleaning fluid has dried completely before loading a cassette.

#### Cautions:

- Keep magnets and metallic objects away from the head. If the head becomes magnetized, noise will increase and the sound will deteriorate.
- Demagnetize the recording/playback head every 20 to 30 hours of use with a head demagnetizer available at an audio store. When demagnetizing the head, the unit should be turned off.

**As the erasure head of the unit is of magnetic type, do not demagnetize it.**

- Do not use anything other than alcohol for cleaning. Thinner and benzine will damage the rubber pinch roller.

### Cleaning the CD pickup lens

If the CD pickup lens is dirty, the sound may be degraded.

#### Open the disc door and clean the lens.

Use a blower (available at a camera store, etc.) to blow off dust on the lens.

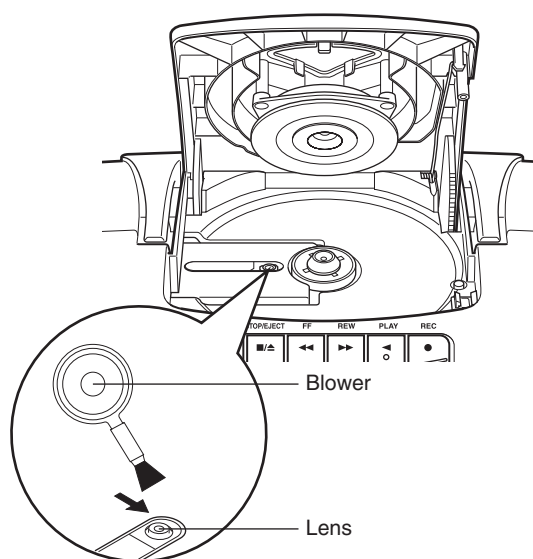

## TROUBLESHOOTING

- If you are having a problem with your unit, check this list for a possible solution before calling for service.
- If you cannot solve the problem from the hints given here, or the unit has been physically damaged, call a qualified person, such as your dealer, for service.

Symptom	Possible cause	Action
Power cannot be turned on.	The power cord is unplugged.	Connect the power cord.
When PLAY ◀ is pressed, tape does not move.	PAUSE    is pressed.	Press PAUSE    again to release it.
Playback sound is at a very low level.	<ul style="list-style-type: none"> <li>• Batteries are run down.</li> <li>• The head is dirty.</li> </ul>	<ul style="list-style-type: none"> <li>• Replace the batteries with new ones.</li> <li>• Clean the head.</li> </ul>
REC ● does not function.	<ul style="list-style-type: none"> <li>• The safety tabs of the cassette have been broken off.</li> <li>• No cassette is loaded.</li> </ul>	<ul style="list-style-type: none"> <li>• Reseal the slots with adhesive tape.</li> <li>• Load a cassette.</li> </ul>
The disc is loaded but does not play.	<ul style="list-style-type: none"> <li>• The disc is upside down.</li> <li>• The disc is dirty.</li> <li>• The disc is damaged or warped.</li> <li>• The lens is dirty.</li> <li>• There is moisture condensation.</li> </ul>	<ul style="list-style-type: none"> <li>• Load the disc with the label side facing up.</li> <li>• Clean the disc.</li> <li>• Replace the disc with a playable one.</li> <li>• Clean the lens.</li> <li>• Turn the unit on and wait one or two hours before use.</li> </ul>
No sound from the speakers.	Headphones are connected.	Disconnect the headphones.
Since the tape speed is irregular, wow and flutter occur.	<ul style="list-style-type: none"> <li>• The pinch roller or capstan is dirty.</li> <li>• Batteries are run down.</li> </ul>	<ul style="list-style-type: none"> <li>• Clean the pinch roller and capstan.</li> <li>• Replace the batteries with new ones.</li> </ul>
Radio reception is poor and there is much static.	The antenna is not properly adjusted.	Adjust the antenna correctly.

### Note:

When the unit is moved from a cold place of around 0°C (32°F) to a warm place, it may not operate normally, because moisture has formed inside the deck. Normal operation will be restored after waiting one or two hours.

### Resetting the unit

If “TROUBLESHOOTING” does not eliminate malfunctioning (failure to operate or display properly, etc.), press the RESET button on the rear of the unit with something having a sharp point.

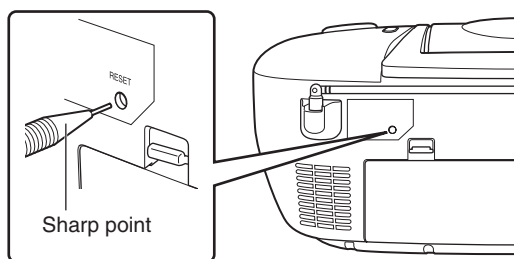

### Note:

Resetting causes the unit to restore its factory default settings and results in all the settings made by the user being deleted.

## SPECIFICATIONS

### CD player

CD capacity	: 1 CD
Signal-to-noise ratio	: 75 dB
Dynamic range	: 60 dB

### Tuner

Frequency range	: FM 87.5 – 108.0 MHz AM 530 – 1 710 kHz
Antennas	: Telescopic antenna for FM Ferrite core antenna for AM

### Cassette deck

Frequency response	: 60 Hz – 10 000 Hz
Wow & flutter	: 0.15% (WRMS)
Fast wind time	: Approx. 150 sec. (C-60 cassette)

### General

Speakers	: 9 cm (3.5") cone × 2
Speaker impedance	: 4 Ω
Output power	: 2 W per channel, min. RMS, driven into 4 Ω at 1 kHz with no more than 10% total harmonic distortion
Output terminals	: PHONES × 1
Power supply	: AC 120 V ~, 60 Hz DC 9 V (R20 (SUM-1)/D (13D)-size batteries × 6)
Power consumption	: 13 W (at operation) 3 W (on standby)
Dimensions	: 420 mm × 178 mm × 250 mm (W/H/D) (16 <sup>9</sup> / <sub>16</sub> " × 7 <sup>1</sup> / <sub>16</sub> " × 9 <sup>7</sup> / <sub>8</sub> " )
Mass	: Approx. 3.2 kg (7.1 lbs) (without batteries)
Accessories provided	: AC power cord × 1

Design and specifications are subject to change without notice.



# WARRANTY REPAIR / REPLACEMENT FORM

PLEASE COMPLETE THE FOLLOWING;

PLEASE NOTE: P. O. BOXES ARE NOT ACCEPTABLE

NAME: \_\_\_\_\_

STREET ADDRESS: \_\_\_\_\_

CITY: \_\_\_\_\_ STATE \_\_\_\_\_ ZIPCODE \_\_\_\_\_

DAY TIME PHONE NUMBER: \_\_\_\_\_

LABOR, S/H CHARGE \$ 19.95 (FOR PRODUCT MORE THAN 90 DAYS, BUT LESS THAN 365 DAYS FROM RETAIL PURCHASE)

LOCAL SALES TAX \$ \_\_\_\_\_

TOTAL PAYMENT \$ \_\_\_\_\_

### METHOD OF PAYMENT

\_\_\_\_\_ CHECK OR MONEY ORDER ENCLOSED

CREDIT CARD	ACCOUNT NUMBER	EXP. DATE
___ VISA	_____	_____
___ MASTERCARD	_____	_____
___ DISCOVER	_____	_____

CARD HOLDER NAME (IF DIFFERENT FROM ABOVE)

CARD HOLDER SIGNATURE

REASON FOR RETURN \_\_\_\_\_

BE SURE TO ENCLOSE COMPLETED FORM, A COPY OF YOUR BILL OF SALE, PAYMENT (IF APPLICABLE), SUPPLIED ACCESSORIES, TOGETHER WITH THE PRODUCT AND RETURN TO THE JVC REPAIR/REPLACEMENT FACILITY NEAREST YOU.

TO OBTAIN THE ADDRESS OF THE LOCATION NEAREST YOU <PLEASE CALL (800) 252-5722 OR VISIT OUR WEBSITE AT [HTTP://WWW.JVC.COM](http://www.jvc.com)





# LIMITED WARRANTY

PORTABLE AUDIO EXCHANGE 1-90

JVC COMPANY OF AMERICA warrants this portable audio product and all parts thereof, except as set forth below ONLY TO THE ORIGINAL PURCHASER AT RETAIL to be FREE FROM DEFECTIVE MATERIALS AND WORKMANSHIP from the date of the original retail purchase for the period shown below. ("The Warranty Period")

**LABOR 90 DAYS**

**PARTS 1 YR**

**THIS LIMITED WARRANTY IS VALID ONLY IN THE FIFTY (50) UNITED STATES, THE DISTRICT OF COLUMBIA AND IN THE COMMONWEALTH OF PUERTO RICO.**

**WHAT WE WILL DO:**

If this product is found to be defective within the warranty period, JVC will, at its option, either repair or replace the defective part(s) or replace the product with a new or refurbished functionally equivalent product. Within 90 days from date of retail sale, repair or replacement will be at no charge to the customer. From 91 to 365 days from the date of retail sale, a charge for labor plus shipping and handling will apply. Please refer to the attached warranty repair/replacement form for the amount of this charge.

**WHAT YOU MUST DO FOR WARRANTY SERVICE:**

***Please do not return your product to the retailer. Instead, please box the product carefully, preferably in the original carton, and ship insured to the JVC repair/replacement facility nearest you.***

To obtain the address of the location nearest you, please call (800) 252-5722 or visit our website at <http://www.jvc.com>

PLEASE BE SURE TO INCLUDE A COPY OF YOUR BILL OF SALE, A COMPLETED WARRANTY REPAIR/REPLACEMENT FORM AND ALL OF THE ORIGINAL ACCESSORIES WHICH CAME WITH YOUR UNIT. IF APPLICABLE, PLEASE INCLUDE PAYMENT AS INDICATED ON ATTACHED REPAIR/REPLACEMENT FORM

If you have any questions concerning your JVC Product, please contact our Customer Relations Department at (800) 252-5722.

**WHAT IS EXCLUDED:**

The warranty does not cover:

1. Products which have been subject to abuse, accident, alteration, modification, tampering, negligence, misuse, faulty installation, lack of reasonable care, or if repaired or serviced by anyone other than a service facility authorized by JVC to render such service, or if affixed to any attachment not provided with the products, or if the model or serial number has been altered, tampered with, defaced or removed.
2. Initial installation, installation and removal, from "built in" entertainment centers, and other mounting systems.
3. Operational adjustments covered in the Owner's Manual, normal maintenance, including head cleaning.
4. Damage that occurs in shipment, due to act of God, and cosmetic damage.
5. Signal reception problems and failures due to line power surge.
6. Products used for commercial purposes (including but not limited to rental).
7. Accessories.
8. Batteries (except that Rechargeable Batteries are covered for 90 days from the date of purchase).

There are no express warranties except as listed above.

**AFTER THE WARRANTY:**

Please contact JVC's Customer Relations Department at (800) 252-5722 to obtain the cost of out of warranty repair or replacement.

THE DURATION OF ANY IMPLIED WARRANTIES, INCLUDING THE IMPLIED WARRANTY OF MERCHANTABILITY, IS LIMITED TO THE DURATION OF THE EXPRESS WARRANTY HEREIN.

JVC SHALL NOT BE LIABLE FOR ANY LOSS OF USE OF THE PRODUCT, INCONVENIENCE, OR ANY OTHER DAMAGES, WHETHER DIRECT, INCIDENTAL OR CONSEQUENTIAL (INCLUDING, WITHOUT LIMITATION, DAMAGE TO TAPES, RECORDS OR DISCS) RESULTING FROM THE USE OF THIS PRODUCT, OR ARISING OUT OF ANY BREACH OF THIS WARRANTY. ALL EXPRESS AND IMPLIED WARRANTIES, INCLUDING THE WARRANTIES OF MERCHANTABILITY AND FITNESS FOR PARTICULAR PURPOSE, ARE LIMITED TO THE WARRANTY PERIOD SET FORTH ABOVE.

Some states do not allow the exclusion of incidental or consequential damages or limitations on how long an implied warranty lasts, so these limitations or exclusions may not apply to you. This warranty gives you specific legal rights and you may also have other rights which vary from state to state.

JVC COMPANY OF AMERICA  
DIVISION OF JVC AMERICAS CORP.

1700 Valley Road  
Wayne, New Jersey 07470

<http://www.jvc.com>

REFURBISHED PRODUCTS CARRY A SEPARATE WARRANTY THIS WARRANTY DOES NOT APPLY. FOR DETAILS OF REFURBISHED PRODUCT WARRANTY, PLEASE REFER TO THE REFURBISHED PRODUCT WARRANTY INFORMATION PACKAGED WITH EACH REFURBISHED PRODUCT.

For customer use:

Enter below the Model No. and Serial No. which are located either on the rear, bottom or side of the cabinet. Retain this information for future reference.

Model No.: \_\_\_\_\_ Serial No.: \_\_\_\_\_

Purchase Date: \_\_\_\_\_ Name of Dealer: \_\_\_\_\_

