

JVC

DIGITAL VIDEO CAMERA

GR-DVL155

Please visit our Homepage on the World Wide Web and answer our Consumer Survey (in English only):

<http://www.jvc-victor.co.jp/english/index-e.html>

For Accessories:

<http://www.jvc-victor.co.jp/english/accessory/>

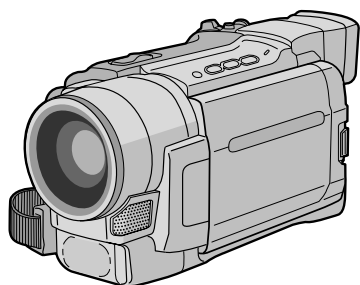

Mini **DV** PAL

INSTRUCTIONS

ENGLISH

CONTENTS

| | |
|---|------------------------|
| AUTOMATIC DEMONSTRATION | 6 |
| GETTING STARTED | 7 - 13 |
| RECORDING & PLAYBACK | 14 - 22 |
| RECORDING | 15 - 18 |
| PLAYBACK | 19 - 22 |
| ADVANCED FEATURES | 23 - 50 |
| FOR RECORDING | 24 - 31 |
| USING MENUS FOR DETAILED ADJUSTMENT | 32 - 37 |
| DUBBING | 38 - 39 |
| USING THE OPTIONAL REMOTE CONTROL UNIT | 40 - 49 |
| SYSTEM CONNECTIONS | 50 |
| REFERENCES | 51 - Back Cover |
| DETAILS | 52 |
| TROUBLESHOOTING | 53 - 56 |
| USER MAINTENANCE | 57 |
| CAUTIONS | 58 - 59 |
| SPECIFICATIONS | 60 - 61 |
| INDEX | 62 - 66 |
| TERMS | 67 - Back Cover |

LYT1002-001A

EN

Dear Customer,

Thank you for purchasing this digital video camera. Before use, please read the safety information and precautions contained in the following pages to ensure safe use of this product.

Using This Instruction Manual

- All major sections and subsections are listed in the Table Of Contents on the cover page.
- Notes appear after most subsections. Be sure to read these as well.
- Basic and advanced features/operation are separated for easier reference.

It is recommended that you . . .

- refer to the Index (☞ pgs. 62 – 66) and familiarize yourself with button locations, etc. before use.
- read thoroughly the Safety Precautions. They contain extremely important information regarding the safe use of this product.

You are recommended to carefully read the cautions on pages 58 and 59 before use.

SAFETY PRECAUTIONS

WARNING:
TO PREVENT FIRE OR SHOCK HAZARD, DO NOT EXPOSE THIS UNIT TO RAIN OR MOISTURE.

CAUTIONS:

- To prevent shock, do not open the cabinet. No user serviceable parts inside. Refer servicing to qualified personnel.
- When you are not using the AC Adapter for a long period of time, it is recommended that you disconnect the power cord from AC outlet.

NOTES:

- The rating plate (serial number plate) and safety caution are on the bottom and/or the back of the main unit.
- The rating information and safety caution of the AC Adapter are on its upper and lower sides.

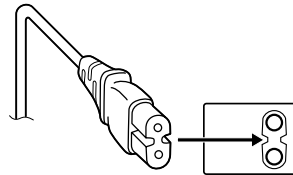
CAUTION:

To avoid electric shock or damage to the unit, first firmly insert the small end of the power cord into the AC Adapter until it is no longer wobbly, and then plug the larger end of the power cord into an AC outlet.

CAUTIONS:

- This camcorder is designed to be used with PAL-type colour television signals. It cannot be used for playback with a television of a different standard. However, live recording and LCD monitor/viewfinder playback are possible anywhere.
- Use the JVC BN-V408U/V416U/V428U battery packs and, to recharge them or to supply power to the camcorder from an AC outlet, use the provided multi-voltage AC Adapter and Power Cord. (An appropriate conversion adapter may be necessary to accommodate different designs of AC outlets in different countries.)

When the equipment is installed in a cabinet or on a shelf, make sure that it has sufficient space on all sides to allow for ventilation (10 cm or more on both sides, on top and at the rear).

Do not block the ventilation holes.

(If the ventilation holes are blocked by a newspaper, or cloth etc. the heat may not be able to get out.)

No naked flame sources, such as lighted candles, should be placed on the apparatus.

When discarding batteries, environmental problems must be considered and the local rules or laws governing the disposal of these batteries must be followed strictly.

The apparatus shall not be exposed to dripping or splashing.

Do not use this equipment in a bathroom or places with water.

Also do not place any containers filled with water or liquids (such as cosmetics or medicines, flower vases, potted plants, cups etc.) on top of this unit.

(If water or liquid is allowed to enter this equipment, fire or electric shock may be caused.)

SAFETY PRECAUTIONS

Do not point the lens or the viewfinder directly into the sun. This can cause eye injuries, as well as lead to the malfunctioning of internal circuitry. There is also a risk of fire or electric shock.

CAUTION!

The following notes concern possible physical damage to the camcorder and to the user.

When carrying, be sure to always securely attach and use the provided shoulder strap. Carrying or holding the camcorder by the viewfinder and/or the LCD monitor can result in dropping the unit, or in a malfunction.

Take care not to get your finger caught in the cassette holder cover. Do not let children operate the camcorder, as they are particularly susceptible to this type of injury.

Do not use a tripod on unsteady or unlevel surfaces. It could tip over, causing serious damage to the camcorder.

CAUTION!

Connecting cables (Audio/Video, S-Video, etc.) to the camcorder and leaving the unit on top of the TV is not recommended, as tripping on the cables will cause the camcorder to fall, resulting in damage.

Mini **DV** PAL

- This camcorder is designed exclusively for the digital video cassette. Only cassettes marked ^{Mini}**DV** can be used with this unit.

Before recording an important scene . . .

- make sure you only use cassettes with the Mini DV mark ^{Mini}**DV**.
- remember that this camcorder is not compatible with other digital video formats.
- remember that this camcorder is intended for private consumer use only. Any commercial use without proper permission is prohibited. (Even if you record an event such as a show, performance or exhibition for personal enjoyment, it is strongly recommended that you obtain permission beforehand.)

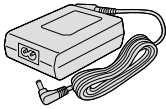

or

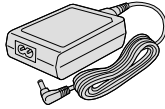

**AC Adapter AP-V10EG,
AP-V11EG or AP-V12EG**

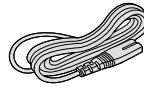

Power Cord

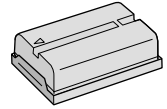

**Battery Pack
BN-V408U**

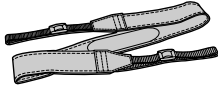

Shoulder Strap

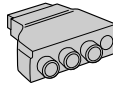

Cable Adapter



**Lens Cap
(See below for
attachment)**



**Core Filter x 1
(for optional S-Video cable
pg. 6 for attachment)**



**Core Filter x 1
(for PC Connection cable
provided with optional
HS-V16KITE software;
pg. 6 for attachment)**

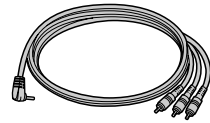

**Audio/Video Cable
(ø3.5 mini-plug to
RCA plug)**

NOTE:

In order to maintain optimum performance of the camcorder, provided cables may be equipped with one or more core filter. If a cable has only one core filter, the end that is closest to the filter should be connected to the camcorder.

How To Attach The Lens Cap

To protect the lens, attach the provided lens cap to the camcorder as shown in the illustration.

NOTE:

To confirm the lens cap is on correctly make sure the cap is flush to the camera.

1

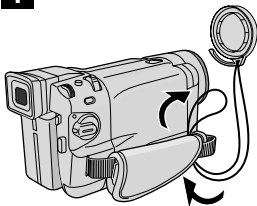

2

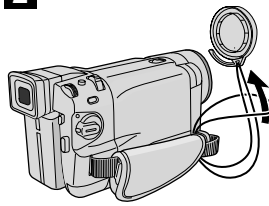

3

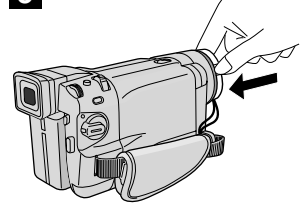

How To Attach The Core Filter

Attach the Core Filter(s) (if provided with your model  pg. 5) to an optional cable(s). The Core Filter reduces interference.

- 1**

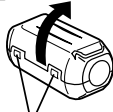

Stopper

Release the stoppers on both ends of the Core Filter.
- 2**

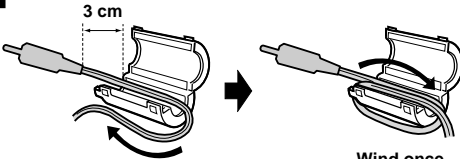

3 cm

Wind once

Run the cable through the Core Filter, leaving approx. 3 cm of cable between the cable plug and the Core Filter. Wind the cable once around the outside of the Core Filter as shown in the illustration.

 - Wind the cable so that it is not slack.

NOTE:
Take care not to damage the cable.
- 3**

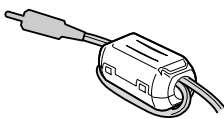

Close the Core Filter until it clicks shut.

- When connecting cables, attach the end with the Core Filter to the camcorder.

AUTOMATIC DEMONSTRATION

Automatic Demonstration takes place when “**DEMO MODE**” is set to “**ON**” (factory-preset).

- Automatic Demonstration starts when there is no operation for about 3 minutes after the Power Switch is set to “**AUTO**” or “**MANUAL**” and no cassette is in the camcorder.
- Performing any operation during the demonstration stops the demonstration temporarily. If no operation is performed for more than 3 minutes after that, the demonstration will resume.
- “**DEMO MODE**” remains “**ON**” even if the camcorder power is turned off.
- To cancel Automatic Demonstration:
 1. Set the Power Switch to “**MANUAL**” while pressing down the Lock Button located on the switch and press the **MENU/BRIGHT** wheel in. The Menu Screen appears.
 2. Rotate the **MENU/BRIGHT** wheel to select “**SYSTEM**” and press it. The SYSTEM Menu appears.
 3. Rotate the **MENU/BRIGHT** wheel to select “**DEMO MODE**” and press it. The Sub Menu appears.
 4. Rotate the **MENU/BRIGHT** wheel to select “**OFF**” and press it.
 5. Rotate the **MENU/BRIGHT** wheel to select “**RETURN**”, and press it twice. The normal screen appears.

MENU/BRIGHT Wheel

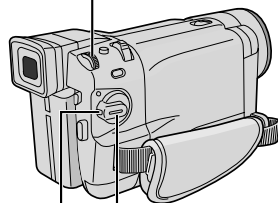

Power Switch

Lock Button

Sub Menu

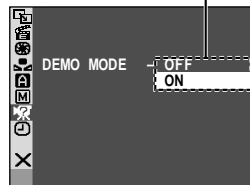

NOTE:

If you do not detach the Lens Cap, you cannot see the actual changes of the Automatic Demonstration activated on the LCD monitor or viewfinder.

GETTING STARTED**CONTENTS**

| | |
|---|--------------|
| Power | 8 – 9 |
| Grip Adjustment | 10 |
| Viewfinder Adjustment | 10 |
| Shoulder Strap Attachment | 10 |
| Tripod Mounting | 10 |
| Date/Time Settings | 11 |
| Loading/Unloading A Cassette | 12 |
| Recording Mode Setting | 13 |

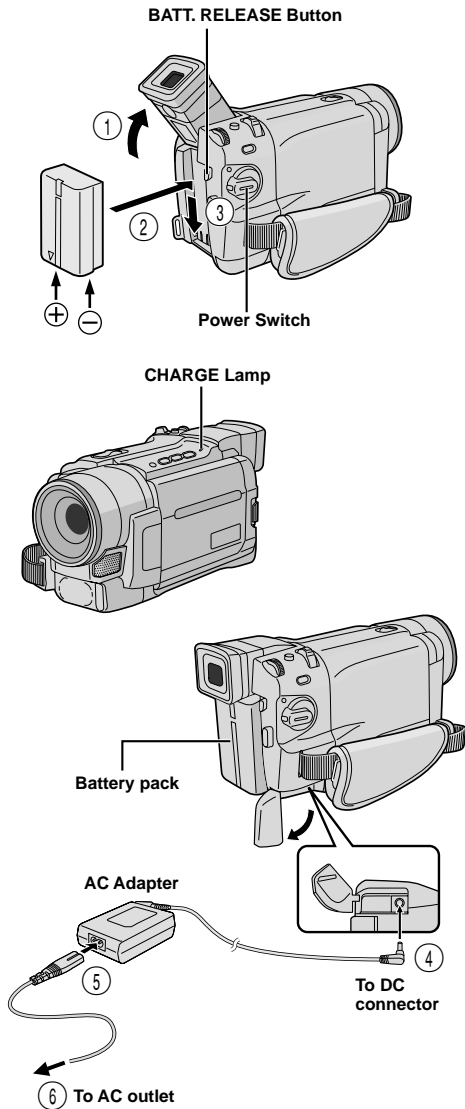

Power

This camcorder's 2-way power supply system lets you choose the most appropriate source of power. Do not use provided power supply units with other equipment.

CHARGING THE BATTERY PACK

- 1** Tilt the viewfinder upward ①. With the arrow on the battery pack pointing downward, push the battery pack slightly against the battery pack mount ②, then slide down the battery pack until it locks in place ③.
- 2** Set the Power Switch to "OFF". Connect the AC Adapter to the camcorder ④, then connect the Power Cord to the AC Adapter ⑤.
- 3** Plug the Power Cord into an AC outlet ⑥. The CHARGE lamp on the camcorder blinks to indicate charging has started.
- 4** When the CHARGE lamp stops blinking but stays lit, charging is finished. Unplug the Power Cord from the AC outlet. Disconnect the AC Adapter from the camcorder.

To Detach The Battery Pack . . .

..... Press **BATT. RELEASE** and pull out the battery pack.

NOTES:

- If the protective cap is attached to the battery pack, remove it first.
- During charging, the camcorder cannot be operated.
- Charging is not possible if the wrong type of battery is used.
- When charging the battery pack for the first time or after a long storage period, the CHARGE lamp may not light. In this case, remove the battery pack from the camcorder, then try charging again.
- If the battery operation time remains extremely short even after having been fully charged, the battery is worn out and needs to be replaced. Please purchase a new one.
- Using the optional AA-V40EG AC Power Adapter/Charger, you can charge the BN-V408U/V416U/V428U battery pack without the camcorder. However, it cannot be used as an AC adapter.

| Battery pack | Charging time |
|---------------------|-----------------------|
| BN-V408U | approx. 1 hr. 30 min. |
| BN-V416U (optional) | approx. 3 hrs. |
| BN-V428U (optional) | approx. 5 hrs. |

ATTENTION

Before detaching the power source, make sure that the camcorder's power is turned off. Failure to do so can result in a camcorder malfunction.

NOTES:

- Recording time is reduced significantly under the following conditions:
 - Zoom or Record-Standby mode is engaged repeatedly.
 - The LCD monitor is used repeatedly.
 - The playback mode is engaged repeatedly.
- Before extended use, it is recommended that you prepare enough battery packs to cover 3 times the planned shooting time.

USING THE BATTERY PACK

Perform step 1 of "CHARGING THE BATTERY PACK" (☞ pg. 8).

Approximate recording time

| Battery pack | LCD monitor on | Viewfinder on |
|---------------------|----------------|----------------|
| BN-V408U | 1 hr. | 1 hr. 15 min. |
| BN-V416U (optional) | 2 hrs. | 2 hrs. 30 min. |
| BN-V428U (optional) | 3 hrs. 30 min. | 4 hrs. 20 min. |
| BN-V840U (optional) | 5 hrs. | 6 hrs. 10 min. |
| BN-V856U (optional) | 7 hrs. | 8 hrs. 40 min. |

INFORMATION

The extended-use battery pack kit is a set composed of a battery pack and AC Power Adapter/Charger:

VU-V840 KIT: BN-V840U battery pack & AA-V15EG AC Power Adapter/Charger

VU-V856 KIT: BN-V856U battery pack & AA-V80EG AC Power Adapter/Charger

Read the kit's instruction manual before using.

Also, by using the optional JVC VC-VBN856U DC Cord, it will be possible to connect BN-V840U or BN-V856U battery packs to the camcorder and supply power directly to the camcorder.

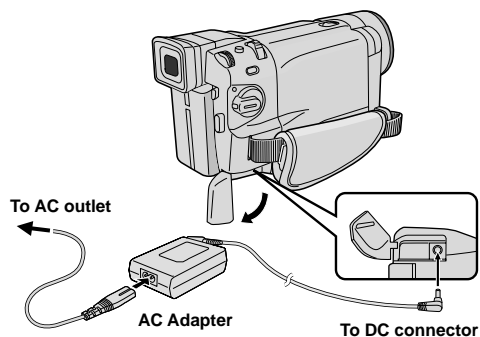
**USING AC POWER**

Use the AC Adapter (connect as shown in the illustration).

NOTES:

- The provided AC Adapter features automatic voltage selection in the AC range from 110 V to 240 V.
- For other notes, ☞ pg. 52.

About Batteries

DANGER! Do not attempt to take the batteries apart, or expose them to flame or excessive heat, as it may cause a fire or explosion.

WARNING! Do not allow the battery or its terminals to come in contact with metals, as this can result in a short circuit and possibly start a fire.

The Benefits of Lithium-Ion Batteries

Lithium-ion battery packs are small but have a large power capacity. However, when one is exposed to cold temperatures (below 10°C), its usage time becomes shorter and it may cease to function. If this happens, place the battery pack in your pocket or other warm, protected place for a short time, then re-attach it to the camcorder. As long as the battery pack itself is not cold, it should not affect performance.

(If you're using a heating pad, make sure the battery pack does not come in direct contact with it.)

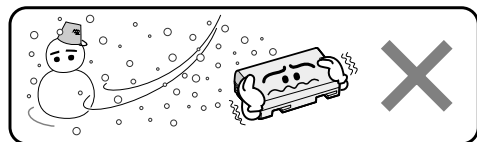

Lithium-ion is vulnerable in colder temperatures.

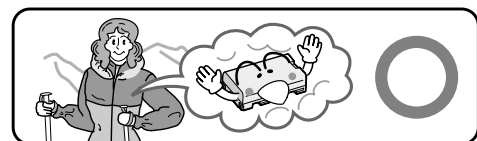

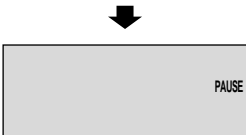
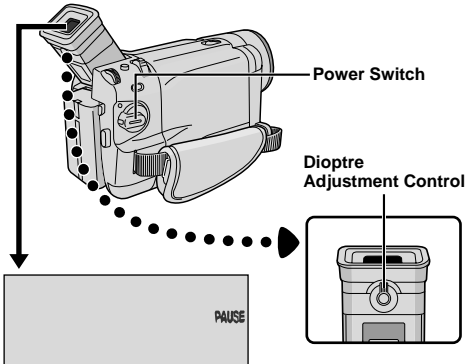
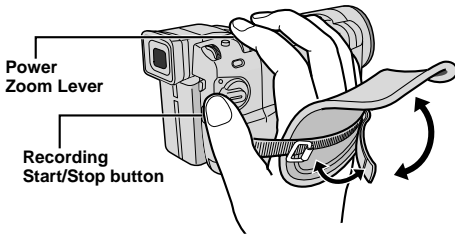

Grip Adjustment

- 1 Separate the Velcro strip.
- 2 Pass your right hand through the loop and grasp the grip.
- 3 Adjust your thumb and fingers through the grip, to easily operate the Recording Start/Stop button and Power Switch and Power Zoom Lever. Be sure to fasten the Velcro strip to your preference.

Viewfinder Adjustment

- 1 Set the Power Switch to "AUTO" or "MANUAL" while pressing down the Lock Button located on the switch.
- 2 Turn the Dioptre Adjustment Control until the indications in the viewfinder are clearly focused.

Shoulder Strap Attachment

- 1 Make sure the battery pack is removed. Following the illustration, thread the strap through the eyelet ①, then fold it back and thread it through the buckle ②. Repeat the procedure to attach the other end of the strap to the other eyelet ③ located under the Grip Strap. Confirm the strap is not twisted.

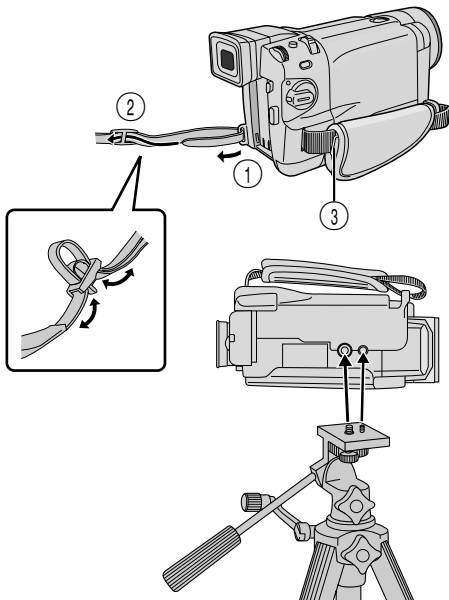

Tripod Mounting

CAUTION

When attaching the camcorder to a tripod, extend its legs to stabilise the camcorder. It is not advised to use small sized tripods. This may cause damage to the unit by falling over.

- 1 To attach the camcorder to a tripod, align the direction stud and screw to the mounting socket and stud hole on the camcorder. Then tighten the screw clockwise. Some tripods are not equipped with studs.

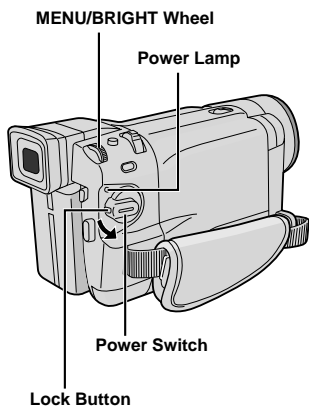

Display

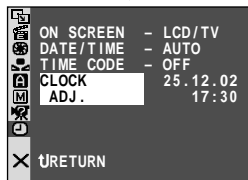
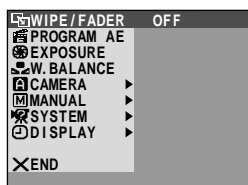

DISPLAY Menu

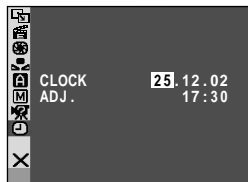

Date/Time Settings

The date/time is recorded onto the tape at all times, but its display can be turned on or off during playback (▶▶ pg. 36, 37).

1 Set the Power Switch to "**MANUAL**" while pressing down the Lock Button located on the switch. The power lamp lights and the camcorder is turned on.

2 Press the **MENU/BRIGHT** wheel in to access the Menu Screen.

3 Rotate the **MENU/BRIGHT** wheel to select "**DISPLAY**". Press it and the DISPLAY Menu appears.

4 Rotate the **MENU/BRIGHT** wheel to select "**CLOCK ADJ.**". Press it and "day" is highlighted. Rotate the **MENU/BRIGHT** wheel to input the day. Press it. Repeat to input the month, year, hour and minute.

Rotate the **MENU/BRIGHT** wheel to select "**RETURN**", and press it twice. The Menu Screen closes.

NOTE:

Even if you select "CLOCK ADJ.", if the parameter is not highlighted the camcorder's internal clock continues to operate. Once you move the highlight bar to the first date/time parameter (day), the clock stops. When you finish setting the minute and press the **MENU/BRIGHT** wheel in, the date and time begin operation from the date and time you just set.

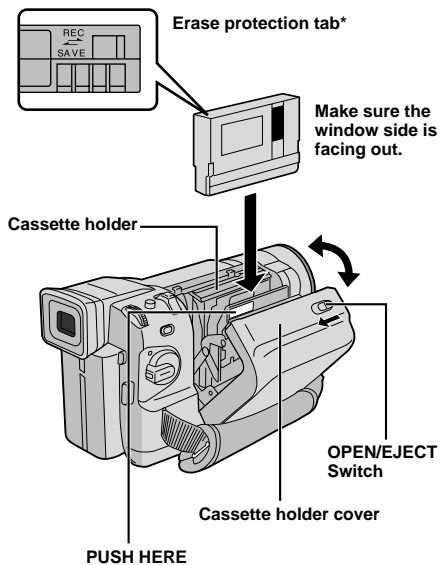

* To Protect Valuable Recordings . . .

.... slide the erase protection tab on the back of the tape in the direction of "SAVE". This prevents the tape from being recorded over. To record on this tape, slide the tab back to "REC" before loading it.

Be sure to press only the section labeled "PUSH HERE" to close the cassette holder; touching other parts may cause your finger to get caught in the cassette holder, resulting in injury or product damage.

NOTES:

- It takes a few seconds for the cassette holder to open. Do not apply force.
- If you wait a few seconds and the cassette holder does not open, close the cassette holder cover and try again. If the cassette holder still does not open, turn the camcorder off then on again.
- If the tape does not load properly, open the cassette holder cover fully and remove the cassette. A few minutes later, insert it again.
- When the camcorder is suddenly moved from a cold place to a warm environment, wait a short time before opening the cassette holder cover.
- Closing the cassette holder cover before the cassette holder comes out may cause damage to the camcorder.
- Even when the camcorder is switched off, a cassette can be loaded or unloaded. After the cassette holder is closed with the camcorder switched off, however, it may not recede. It is recommended to turn the power on before loading or unloading.
- When resuming recording, once you open the cassette holder cover a blank portion will be recorded on the tape or a previously recorded scene will be erased (recorded over) regardless of whether the cassette holder came out or not. See page 18 for information about recording from the middle of a tape.
- Loosen the Grip Strap if it appears to interfere with the cassette holder cover operation (☞ pg. 10).

Loading/Unloading A Cassette

The camcorder needs to be powered up to load or eject a cassette.

1 Slide and hold **OPEN/EJECT** in the direction of the arrow then pull the cassette holder cover open until it locks. The cassette holder opens automatically.

- Do not touch internal components.

2 Insert or remove a tape and press "PUSH HERE" to close the cassette holder.

- Once the cassette holder is closed, it recedes automatically. Wait until it recedes completely before closing the cassette holder cover.
- When the battery's charge is low, you may not be able to close the cassette holder cover. Do not apply force. Replace the battery with a fully charged one before continuing.

3 Close the cassette holder cover firmly until it locks into place.

Approximate recording time

| Tape | Recording mode | |
|---------|----------------|----------|
| | SP | LP |
| 30 min. | 30 min. | 45 min. |
| 60 min. | 60 min. | 90 min. |
| 80 min. | 80 min. | 120 min. |

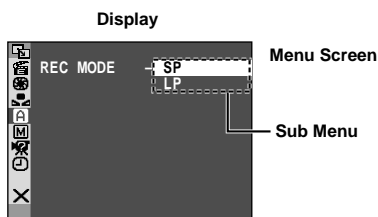
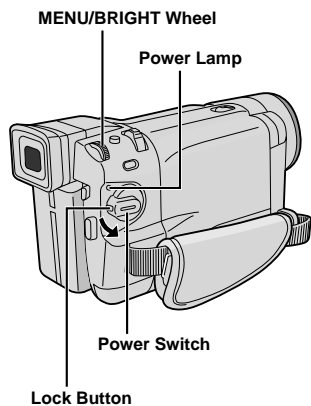

Recording Mode Setting

Set the tape recording mode depending on your preference.

1 Set the Power Switch to “**MANUAL**” while pressing down the Lock Button located on the switch. The power lamp lights and the camcorder is turned on.

2 Press the **MENU/BRIGHT** wheel in. The Menu Screen appears.

3 Rotate the **MENU/BRIGHT** wheel to select “**A** CAMERA” and press it. The CAMERA Menu appears.

4 Rotate the **MENU/BRIGHT** wheel to select “REC MODE” and press it. The Sub Menu appears. Select “SP” or “LP” by rotating the **MENU/BRIGHT** wheel and press it. Rotate the **MENU/BRIGHT** wheel to select “**U** RETURN”, and press it twice. The Menu Screen closes.

- Audio Dubbing (pg. 48) and Insert Editing (pg. 49) are possible on tapes recorded in the SP mode.
- “LP” (Long Play) is more economical, providing 1.5 times the recording time.

NOTES:

- If the recording mode is switched during recording, the playback picture will be blurred at the switching point.
- It is recommended that tapes recorded in the LP mode on this camcorder be played back on this camcorder.
- During playback of a tape recorded on another camcorder, blocks of noise may appear or there may be momentary pauses in the sound.

RECORDING & PLAYBACK

CONTENTS

| | |
|-------------------------------|---------|
| RECORDING | 15 – 18 |
| Basic Recording | 15 |
| Journalistic Shooting | 16 |
| Self-Recording | 16 |
| Operation Mode | 16 |
| Zooming | 17 |
| Time Code | 18 |
| PLAYBACK | 19 – 22 |
| Normal Playback | 19 |
| Still Playback | 19 |
| Shuttle Search | 19 |
| Frame-By-Frame Playback | 19 |
| Connections | 20 – 21 |
| Blank Search | 22 |

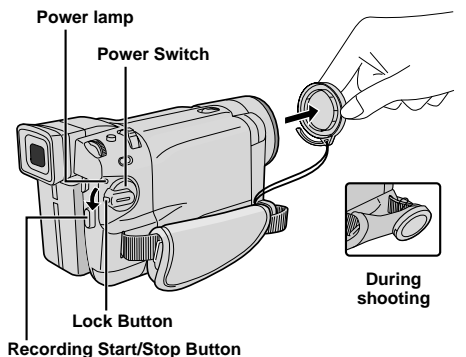

Basic Recording

NOTE:

You should already have performed the procedures listed below. If not, do so before continuing.

- Power (☞ pg. 8)
- Grip Adjustment (☞ pg. 10)
- Viewfinder Adjustment (☞ pg. 10)
- Load A Cassette (☞ pg. 12)
- Recording Mode Setting (☞ pg. 13)

- 1 Remove the lens cap.
- 2 Set the Power Switch to "AUTO" or "MANUAL" while pressing down the Lock Button located on the switch.

Shooting while using the LCD monitor: Make sure the LCD monitor is fully open. Tilt it upward/downward for best viewability.

Shooting while using the viewfinder: Close the LCD monitor.

- The power lamp lights and the camcorder enters the Record-Standby mode. "PAUSE" is displayed.

- 3 Press the Recording Start/Stop Button. "REC" appears while recording is in progress.

To Stop Recording . . .

.... press the Recording Start/Stop Button. The camcorder re-enters the Record-Standby mode.

To Adjust The Brightness Of The Display . . .

.... rotate the MENU/BRIGHT wheel until the bright level indicator on the display moves and the appropriate brightness is reached.

NOTES:

- If the Record-Standby mode continues for 5 minutes, the camcorder's power shuts off automatically. To turn the camcorder on again, set the Power Switch to "OFF", then back to "AUTO" or "MANUAL".
- The image will not appear simultaneously on the LCD monitor and the viewfinder. It will appear in the viewfinder when the LCD monitor is in the lock position, and it will appear on the LCD monitor when fully extended.
- When a blank portion is left between recorded scenes on the tape, the time code is interrupted and errors may occur when editing the tape. To avoid this, refer to "Recording from the middle of a tape" (☞ pg. 18).
- To turn the tally lamp or beep sounds off, ☞ pg. 32, 34.

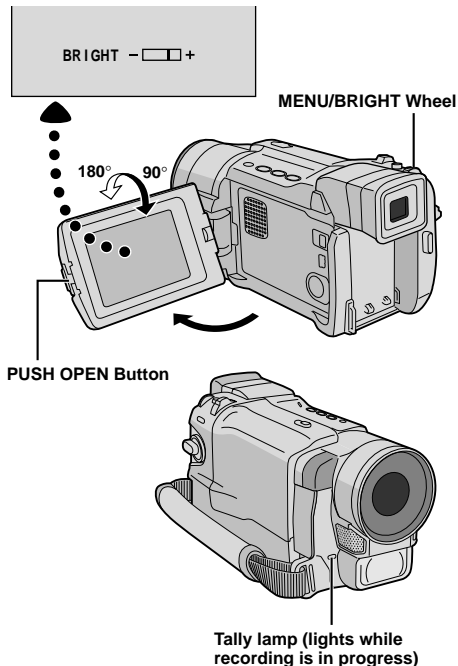
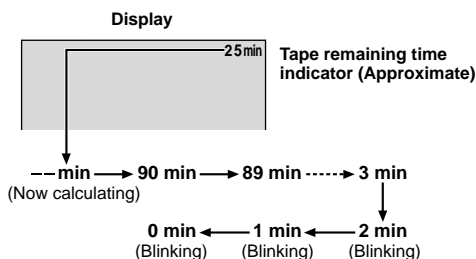

Self-Recording

To turn on the camcorder, set the Power Switch to any operation mode except "OFF" while pressing down the Lock Button located on the switch.

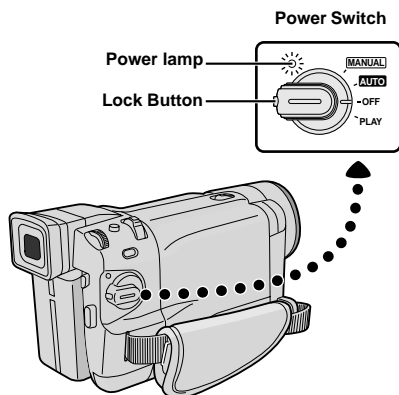

When the Power Switch is set to "AUTO", "A" appears. When set to "MANUAL" or "PLAY", there is no indication.

JOURNALISTIC SHOOTING

In some situations, different shooting angles may provide more dramatic results. Hold the camcorder in the desired position and tilt the LCD monitor in the most convenient direction. It can rotate 270° (90° downward, 180° upward).

SELF-RECORDING

You can shoot yourself while viewing your own image in the LCD monitor. Open the LCD monitor and tilt it upward 180° so that it faces forward, then point the lens toward yourself and start recording.

Operation Mode

Choose the appropriate operation mode according to your preference using the Power Switch.

Power Switch Position**MANUAL:**

Allows you to set various recording functions using the Menus. If you want more creative capabilities than Full Auto recording, try this mode.

AUTO (Full Auto):

Allows you to record using NO special effects or manual adjustments. Suitable for standard recording.

OFF:

Allows you to switch off the camcorder.

PLAY:

- Allows you to play back a recording on the tape.
- Allows you to transfer a still image recorded on the tape to a computer.

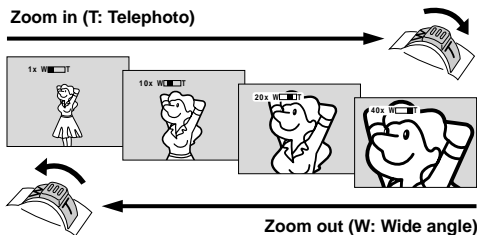
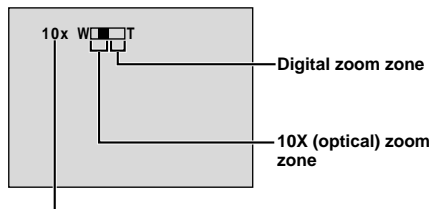
Zoom in (T: Telephoto)**Zoom display**

Approximate zoom ratio

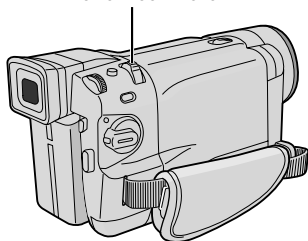
Power Zoom Lever**FEATURE: Zooming****PURPOSE:**

To produce the zoom in/out effect, or an instantaneous change in image magnification.

OPERATION:**Zoom In**

Slide the Power Zoom Lever towards "T".

Zoom Out

Slide the Power Zoom Lever towards "W".

■ The further you slide the Power Zoom Lever, the quicker the zoom action.

NOTES:

- Focusing may become unstable during Zooming. In this case, set the zoom while in Record-Standby, lock the focus by using the manual focus (☞ pg. 29), then zoom in or out in Record mode.
- Zooming is possible to a maximum of 500X, or it can be switched to 10X magnification using the optical zoom (☞ pg. 33).
- Zoom magnification of over 10X is done through Digital image processing, and is therefore called Digital Zoom.
- During Digital zoom, the quality of image may suffer.
- Macro shooting (as close as approx. 5 cm to the subject) is possible when the Power Zoom Lever is set all the way to "W". Also see "TELE MACRO" in the Menu Screen on page 34.

Time Code

During recording, a time code is recorded on the tape. This code is to confirm the location of the recorded scene on the tape during playback.

If recording starts from a blank portion of the tape, the time code begins counting from "00:00:00" (minute:second:frame). If recording starts from the end of a previously recorded scene, the time code continues from the last time code number.

To perform Random Assemble Editing (☞ pg. 43 – 47), time code is necessary. If during recording a blank portion is left partway through the tape, the time code is interrupted. When recording is resumed, the time code starts counting up again from "00:00:00". This means the camcorder may record the same time codes as those existing in a previously recorded scene. To prevent this, perform "Recording From The Middle of A Tape" below in the following cases;

- When shooting again after playing back a recorded tape.
- When power shuts off during shooting.
- When a tape is removed and re-inserted during shooting.
- When shooting using a partially recorded tape.
- When shooting on a blank portion located partway through the tape.
- When shooting again after shooting a scene then opening/closing the cassette holder cover.

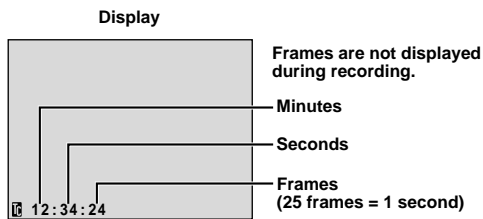

Recording From The Middle Of A Tape

1. Play back a tape or use Blank Search (☞ pg. 22) to find the spot at which you want to start recording, then engage the Still Playback mode (☞ pg. 19).
2. Set the Power Switch to "AUTO" or "MANUAL" while pressing down the Lock Button located on the switch, then start recording.

NOTES:

- The time code cannot be reset.
- During fast-forwarding and rewinding, the time code indication does not move smoothly.
- The time code is displayed only when "TIME CODE" is set to "ON" (☞ pg. 35, 36).

When a blank portion is recorded on a tape

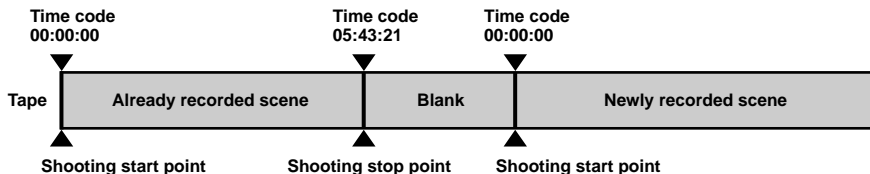

Proper recording

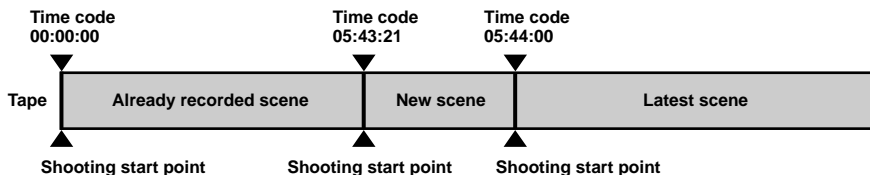

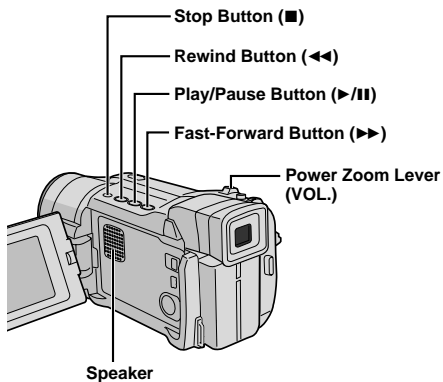

Normal Playback

1 Load a tape (📖 pg. 12).

2 Set the Power Switch to "PLAY" while pressing down the Lock Button located on the switch. To start playback, press ▶/||.

- To stop playback, press ■.
- Press ◀◀ to rewind, or ▶▶ to fast-forward the tape during Stop mode.

To Control The Speaker Volume . . .

..... slide the Power Zoom Lever (VOL.) towards "+" to turn up the volume, or towards "-" to turn down the volume.

NOTES:

- If Stop mode continues for 5 minutes when power is supplied from a battery, the camcorder shuts off automatically. To turn on again, set the Power Switch to "OFF", then to "PLAY".
- The playback picture can be viewed in the LCD monitor, viewfinder or on a connected TV (📖 pg. 20).
- You can also view the playback picture on the LCD monitor with it flipped over and pushed against the camera body.
- LCD monitor/viewfinder indications:
 - When power is supplied from a battery: the "☐" battery pack remaining power indicator is displayed.
 - When power is supplied from an AC outlet: "☐" does not appear.
 - During Stop mode, none of the indications are displayed.
- When a cable is connected to the AV connector, the sound is not heard from the speaker.

Still Playback: Pauses during playback.

- 1) Press ▶/|| during playback.
 - 2) To resume normal playback, press ▶/|| again.
- If still playback continues for more than about 3 minutes, the camcorder's Stop mode is automatically engaged. After 5 minutes in the Stop mode, the camcorder's power is automatically turned off.
 - When ▶/|| is pressed, the image may not pause immediately while the camcorder stabilises the still image.

Shuttle Search: Allows high-speed search in either direction.

- 1) Press ▶▶ for forward or ◀◀ for reverse search during playback.
 - 2) To resume normal playback, press ▶/||.
- During playback, press and hold ◀◀ or ▶▶. The search continues as long as you hold the button. Once you release it, normal playback resumes.
 - A slight mosaic effect appears on screen during Shuttle Search. This is not a malfunction.

Frame-By-Frame Playback: Allows frame-by-frame search.

- 1) Engage Still Playback.
 - 2) Rotate the MENU/BRIGHT wheel towards "+" for forward Frame-By-Frame Playback, or towards "-" for reverse Frame-By-Frame Playback during Still Playback.
- To resume normal playback, press ▶/||.

ATTENTION

During Shuttle Search, parts of the picture may not be clearly visible, particularly on the left side of the screen.

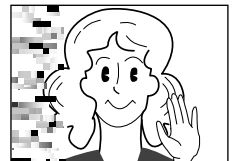

Connections

Use the provided Audio/Video cable and optional S-Video cable.

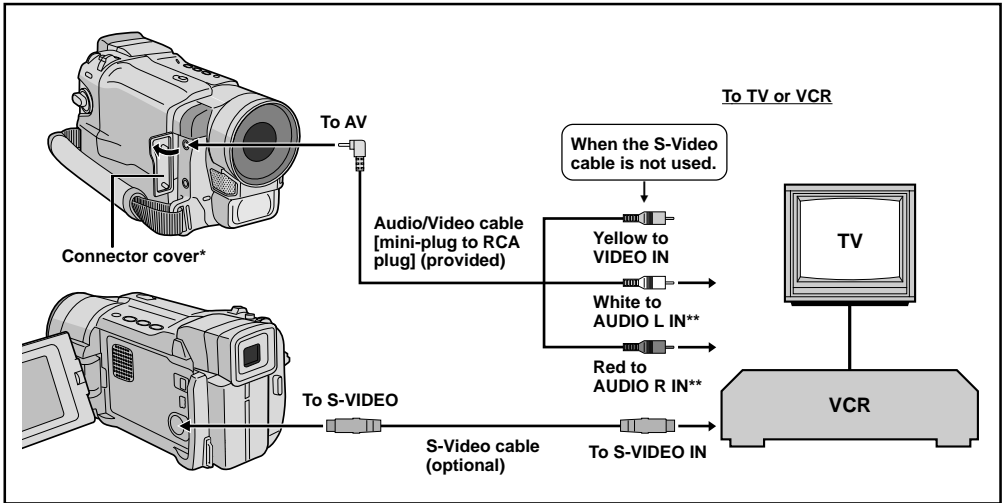

* When connecting the cables, open this cover.

** The Audio cable is not required for watching still images only.

If your TV/VCR has a 21-pin connector

Use the provided Cable Adapter.

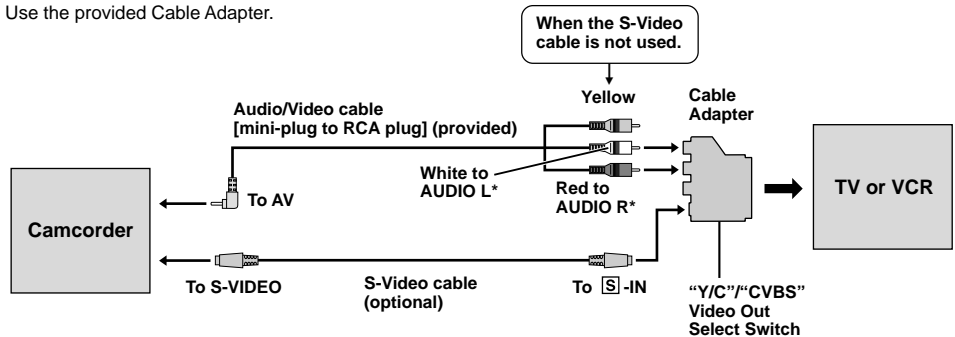

* The Audio cable is not required for watching still images only.

NOTE:

Set the video out select switch of the cable adapter as required:

Y/C : When connecting to a TV or VCR which accepts Y/C signals and uses an S-Video cable.

CVBS : When connecting to a TV or VCR which does not accept Y/C signals and uses an audio/video cable.

- 1** Make sure all units are turned off.
- 2** Connect the camcorder to a TV or VCR as shown in the illustration (☞ pg. 20).
If using a VCR . . . go to step 3.
If not . . . go to step 4.
- 3** Connect the VCR output to the TV input, referring to your VCR's instruction manual.
- 4** Turn on the camcorder, the VCR and the TV.
- 5** Set the VCR to its AUX input mode, and set the TV to its VIDEO mode.

To choose whether or not the following displays appear on the connected TV . . .

- Date/Time
..... set "DATE/TIME" to "AUTO", "ON" or "OFF" in the Menu Screen (☞ pg. 36).
- Time Code
..... set "TIME CODE" to "ON" or "OFF" in the Menu Screen (☞ pg. 36).
- Playback Sound Mode, Tape Speed And Tape Running Displays for tape playback
..... set "ON SCREEN" to "LCD" or "LCD/TV" in the Menu Screen (☞ pg. 36).

NOTES:

- It is recommended to use the AC Adapter as the power supply instead of the battery pack (☞ pg. 9).
- To monitor the picture and sound from the camcorder without inserting a tape, set the camcorder's Power Switch to "AUTO" or "MANUAL", then set your TV to the appropriate input mode.
- Make sure you adjust the TV sound volume to its minimum level to avoid a sudden burst of sound when the camcorder is turned on.
- If you have a TV or speakers that are not specially shielded, do not place the speakers adjacent to the TV as interference will occur in the camcorder playback picture.
- While the Audio/Video cable is connected to the AV connector, sound cannot be heard from the speaker.

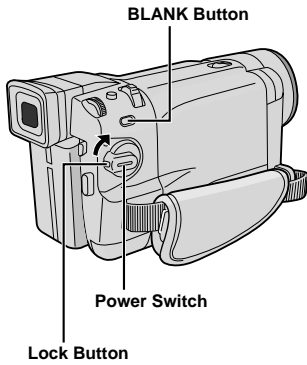

Display



Stop Button (■)

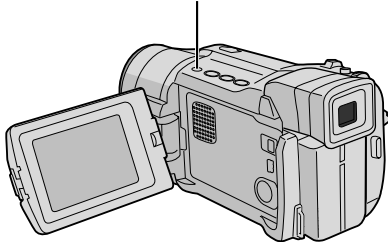

Blank Search

Helps you find where you should start recording in the middle of a tape to avoid time code interruption (☞ pg. 18).

- 1** Load a tape (☞ pg. 12).
- 2** Set the Power Switch to "PLAY" while pressing down the Lock Button located on the switch.
- 3** Press **BLANK**.
 - "BLANK SEARCH" appears blinking and the camcorder automatically starts reverse or forward shuttle search, then stops at the spot which is about 3 seconds of tape before the beginning of the detected blank portion.

To cancel Blank Search midway . . .

..... press ■.

NOTES:

- In step 3, if the current position is at a blank portion the camcorder searches in the reverse direction, and if the current position is at a recorded portion the camcorder searches in the forward direction.
- Blank Search does not work if "HEAD CLEANING REQUIRED. USE CLEANING CASSETTE" has appeared with the tape.
- If the beginning or end of the tape is reached during Blank Search, the camcorder stops automatically.
- A blank portion which is shorter than 5 seconds of tape may not be detected.
- The detected blank portion may be located between recorded scenes. Before you start recording, make sure there is no recorded scene after the blank portion.

ADVANCED FEATURES

CONTENTS

| | |
|--|---------|
| FOR RECORDING | 24 – 31 |
| Night-Scope | 24 |
| Programme AE With Special Effects | 24 – 25 |
| Fade/Wipe Effects | 26 – 27 |
| Snapshot | 28 |
| Auto Focus/Manual Focus | 29 |
| Exposure Control | 30 |
| Iris Lock | 30 |
| White Balance Adjustment | 31 |
| Manual White Balance Operation | 31 |
| USING MENUS FOR DETAILED ADJUSTMENT | 32 – 37 |
| For Recording Menu | 32 – 35 |
| For Playback Menu | 36 – 37 |
| DUBBING | 38 – 39 |
| Dubbing To A VCR | 38 |
| Dubbing To A Video Unit Equipped With A DV Connector | 39 |
| USING THE OPTIONAL REMOTE CONTROL UNIT | 40 – 49 |
| Installing The Battery | 40 |
| Playback Zoom | 42 |
| Random Assemble Editing | 43 – 47 |
| For More Accurate Editing | 47 |
| Audio Dubbing | 48 |
| Insert Editing | 49 |
| SYSTEM CONNECTIONS | 50 |
| Connection To A Personal Computer | 50 |

NOTES:

- During Night-Scope, the following functions or settings cannot be activated and its indicator blinks or goes out:
 - Some modes of "Programme AE With Special Effects" (☞ pg. 24, 25).
 - "GAIN UP" in the CAMERA Menu (☞ pg. 33).
 - "DIS" in the MANUAL Menu (☞ pg. 33).
- During Night-Scope, it may be difficult to bring the camcorder into focus. To prevent this, use of manual focus and/or a tripod is recommended.

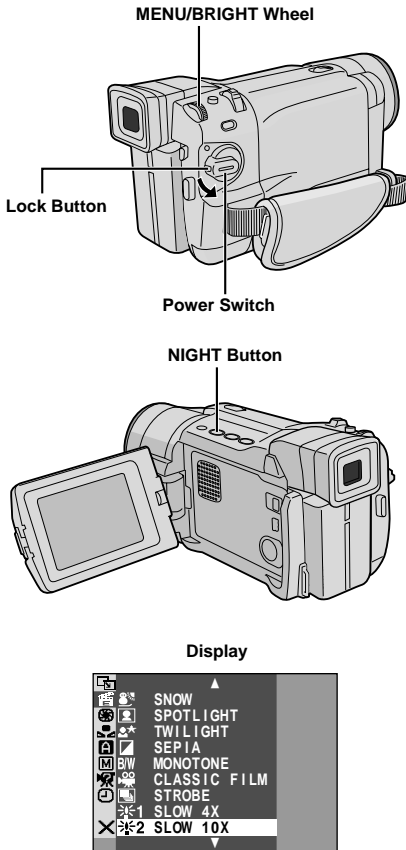
**Night-Scope**

Makes dark subjects or areas even brighter than they would be under good natural lighting. Although the recorded image is not grainy, it may look as if it is strobing due to the slow shutter speed.

1 Set the Power Switch to "MANUAL" while pressing down the Lock Button located on the switch.

2 Press **NIGHT** so that the Night-Scope indicator "NIGHT" appears.

- The shutter speed is automatically adjusted to provide up to 30 times sensitivity.
- "A" appears beside "NIGHT" while the shutter speed is being automatically adjusted.

To Deactivate Night-Scope . . .

..... press **NIGHT** again so that the Night-Scope indicator disappears.

Programme AE With Special Effects

1 Set the Power Switch to "MANUAL" while pressing down the Lock Button located on the switch.

2 Press the **MENU/BRIGHT** wheel in. The Menu Screen appears.

3 Rotate the **MENU/BRIGHT** wheel to select "PROGRAMME AE", then press it.

4 Rotate the **MENU/BRIGHT** wheel to select the desired mode (☞ pg. 25), then press it. Selection is complete. Press the **MENU/BRIGHT** wheel in again. The Menu Screen closes.

- The PROGRAMME AE Menu disappears and the selected mode is activated. The selected mode indicator appears.

To Deactivate The Selected Mode . . .

..... select "OFF" in step 4.

NOTES:

- Programme AE with special effects can be changed during recording or during Record-Standby.
- Some modes of Programme AE special effects cannot be used during Night-Scope.

IMPORTANT

Some modes of Programme AE with special effects cannot be used with certain Fade/Wipe Effects (☞ pg. 26, 27). If an unusable mode is selected, its indicator blinks or goes out.

SHUTTER

1/50—The shutter speed is fixed at 1/50th of a second. Black bands that usually appear when shooting a TV screen become narrower.

1/120—The shutter speed is fixed at 1/120th of a second. The flickering that occurs when shooting under a fluorescent light or mercury-vapour lamp is reduced.



 **SPORTS**
(Variable
Shutter Speed:
1/250 – 1/4000)

This setting allows fast-moving images to be captured one frame at a time, for vivid, stable slow-motion playback. The faster the shutter speed, the darker the picture becomes. Use the shutter function under good lighting conditions.

**SNOW**

Compensates for subjects that may otherwise appear too dark when shooting in extremely bright surroundings such as in the snow.

**SPOTLIGHT**

Compensates for subjects that may otherwise appear too bright when shooting under extremely strong direct lighting such as spotlights.

NOTE:

“SPOTLIGHT” has the same effect as -3 with the exposure control (pg. 30).

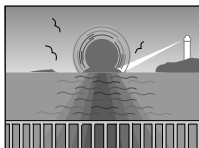

 **TWILIGHT**

Makes evening scenes look more natural.

White Balance (pg. 31) is initially set to , but can be changed to your desired setting. When Twilight is chosen, the camcorder automatically adjusts the focus from approx. 10 m to infinity. From less than 10 m, adjust the focus manually.

 **SEPIA**

Recorded scenes have a brownish tint like old photos. Combine this with the Cinema mode for a classic look.

B/W MONOTONE

Like black and white films, your footage is shot in B/W. Used together with the Cinema mode, it enhances the “classic film” effect.

**CLASSIC FILM**

Gives recorded scenes a strobe effect.

**STROBE**

Your recording looks like a series of consecutive snapshots.

SLOW (Slow Shutter)

Lights dark subjects or areas even brighter than they would be under good natural lighting. Use “SLOW” only in dark areas.

 **1 SLOW 4X**

Slow Shutter raises light sensitivity to allow shooting in dark environments.

 **2 SLOW 10X**

Slow Shutter raises light sensitivity further to allow shooting in even darker environments.

NOTES:

- When using “SLOW”, the image takes on a strobe-like effect.
- When using “SLOW”, it may be difficult to bring the camcorder into focus. To prevent this, use of manual focus and/or a tripod is recommended.

IMPORTANT

Some Fade/Wipe Effects cannot be used with certain modes of Programme AE with special effects (▶ pg. 24, 25). If an unusable Fade/Wipe Effect is selected, its indicator blinks or goes out.

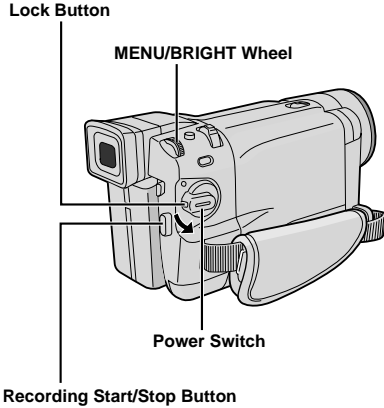
**Fade/Wipe Effects**

These effects let you make pro-style scene transitions. Use them to spice up the transition from one scene to the next.

Fade or Wipe works when tape recording is started or when you stop recording.

- 1** Set the Power Switch to "**MANUAL**" while pressing down the Lock Button located on the switch.
- 2** Press the **MENU/BRIGHT** wheel in. The Menu Screen appears.
- 3** Rotate the **MENU/BRIGHT** wheel to select "**WIPE/FADER**", then press it.
- 4** Rotate the **MENU/BRIGHT** wheel to select the desired function, then press it. Selection is complete. Press the **MENU/BRIGHT** wheel in again.
 - The **WIPE/FADER** Menu disappears and the effect is reserved. The indicator representing the selected effect appears.
- 5** Press the Recording Start/Stop Button to activate the Fade-in/out or Wipe-in/out.









To Deactivate The Selected Effect . . .

..... select "OFF" in step 4.

NOTE:

You can extend the length of a Fade or Wipe by pressing and holding the Recording Start/Stop Button.

Fader And Wipe Menu

| Menu | Effect |
|--|---|
|  FADER — WHITE | Fade in or out with a white screen. |
|  FADER — BLACK | Fade in or out with a black screen. |
|  FADER — B.W | Fade in to a colour screen from a black and white screen, or fade out from colour to black and white. |
|  WIPE — CORNER | Wipe in on a black screen from the upper right to the lower left corner, or wipe out from lower left to upper right, leaving a black screen. |
|  WIPE — WINDOW | The scene starts in the centre of a black screen and wipes in toward the corners, or comes in from the corners, gradually wiping out to the centre. |
|  WIPE — SLIDE | Wipe in from right to left, or wipe out from left to right. |
|  WIPE — DOOR | Wipe in as the two halves of a black screen open to the left and right, revealing the scene, or wipe out and the black screen reappears from left and right to cover the scene. |
|  WIPE — SCROLL | The scene wipes in from the bottom to the top of a black screen, or wipes out from top to bottom, leaving a black screen. |
|  WIPE — SHUTTER | Wipe in from the centre of a black screen toward the top and bottom, or wipe out from the top and bottom toward the centre leaving a black screen. |

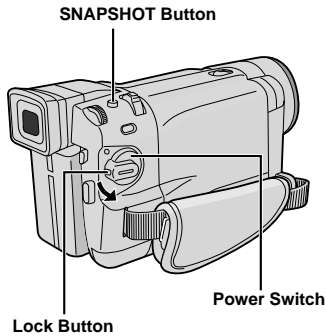

Display

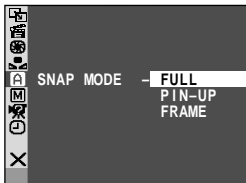

FULL
Snapshot mode
with no frame



PIN-UP
Pin-Up mode



FRAME
Snapshot mode
with frame

There is the sound effect of a shutter closing.

Snapshot

This feature lets you record still images that look like photographs onto a tape.

SNAPSHOT MODE SELECTION

- 1** Set the Power Switch to "MANUAL" while pressing down the Lock Button located on the switch.
- 2** Press the **MENU/BRIGHT** wheel in. The Menu Screen appears.
- 3** Rotate the **MENU/BRIGHT** wheel to select "CAMERA". Press it and the CAMERA Menu appears.
- 4** Rotate the **MENU/BRIGHT** wheel to select "SNAP MODE", then press it.
- 5** Rotate the **MENU/BRIGHT** wheel to select the desired Snapshot mode, then press it. Rotate the **MENU/BRIGHT** wheel to select "RETURN" and press it twice. The Menu Screen closes.

SNAPSHOT RECORDING

- 1** Press **SNAPSHOT**. "PHOTO" appears while the snapshot is being taken.

If you press during Record-Standby . . .

..... "PHOTO" appears and a still image will be recorded for approx. 6 seconds, then the camcorder re-enters the Record-Standby mode.

If you press during Recording . . .

..... "PHOTO" appears and a still image will be recorded for approx. 6 seconds, then the normal recording resumes.

- Regardless of the Power Switch position ("AUTO" or "MANUAL"), Snapshot recording takes place using the selected Snapshot mode.

Motor Drive Mode

Keeping **SNAPSHOT** pressed provides an effect similar to serial photography. (Interval between still images: approx. 1 second)

NOTES:

- To remove the shutter sound, (☞ "BEEP" on pg. 32, 34).
- If Snapshot recording is not possible, "PHOTO" blinks when **SNAPSHOT** is pressed.
- If Programme AE with special effects (☞ pg. 24) is engaged, certain modes of Programme AE with special effects are disabled during Snapshot recording. In such a case, the icon blinks.
- If **SNAPSHOT** is pressed when "DIS" is set to "ON" (☞ pg. 33), the Stabiliser will be disabled.
- During tape playback as well, all snapshot modes are available. However, the shutter sound is not heard.
- During Snapshot recording, the image displayed in the viewfinder may be partially missing. However, there is no effect in the recorded image.
- When a cable is connected to the AV connector, the shutter sound is not heard from the speaker, however it is recorded onto the tape.

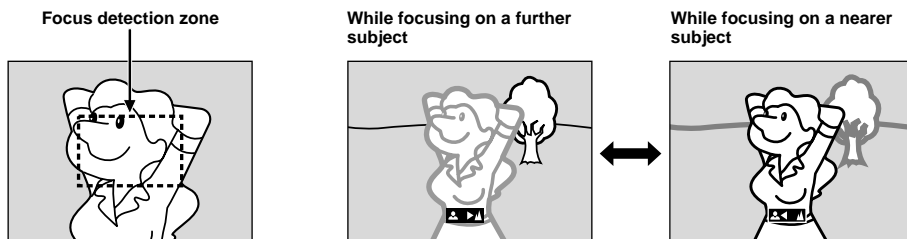

FEATURE: Auto Focus

PURPOSE:

The camcorder's Full Range AF system offers continuous shooting ability from close-up (as close as approx. 5 cm to the subject) to infinity.

However, correct focus may not be obtainable in the situations listed below (in these cases use manual focusing):

- When two subjects overlap in the same scene.
- When illumination is low.*
- When the subject has no contrast (difference in brightness and darkness), such as a flat, one-colour wall, or a clear, blue sky.*
- When a dark object is barely visible in the viewfinder.*
- When the scene contains minute patterns or identical patterns that are regularly repeated.
- When the scene is affected by sunbeams or light reflecting off the surface of a body of water.
- When shooting a scene with a high-contrast background.

* The following low-contrast warnings appear blinking: ▲, ◀, ▶ and 👤

NOTES:

- If the lens is smeared or blurred, accurate focusing is not possible. Keep the lens clean, wiping with a piece of soft cloth if it gets dirty. When condensation occurs, wipe with a soft cloth or wait for it to dry naturally.
- When shooting a subject close to the lens, zoom out first (☞ pg. 17). If zoomed-in in the auto focus mode, the camcorder may automatically zoom out depending on the distance between the camcorder and the subject. This will not occur when "TELE MACRO" (☞ pg. 34) is activated.

FEATURE: Manual Focus

PURPOSE:

To obtain correct focus.

OPERATION:

- 1) If you are using the viewfinder, you should already have made the necessary viewfinder adjustments (☞ pg. 10).
- 2) Set the Power Switch to "**MANUAL**" while pressing down the Lock Button located on the switch, then press **FOCUS** (☞ pgs. 62 and 63, Ⓜ FOCUS Button). The manual focus indicator appears.
- 3) To focus on a farther subject, rotate the **MENU/BRIGHT** wheel towards "+". "▶" appears and blinks. To focus on a nearer subject, rotate the **MENU/BRIGHT** wheel towards "-". "◀" appears and blinks.
- 4) Press the **MENU/BRIGHT** wheel in. Focus adjustment is complete.

To reset to Auto Focus, press **FOCUS** twice or set the Power Switch to "**AUTO**".

If **FOCUS** is pressed once, the camcorder will enter the focus adjustment mode again.

NOTES:

- Be sure to focus the lens in the maximum telephoto position when you use the Manual Focus mode. If you focus in on a subject in the wide-angle position, sharply focused images cannot be obtained when zoomed up because the depth-of-field is reduced at longer focal lengths.
- When the focus level cannot be adjusted any further or closer, "▲" or "👤" will blink.

Exposure Control

Manual exposure adjustment is recommended in the following situations:

- When shooting using reverse lighting or when the background is too bright.
- When shooting on a reflective natural background such as at the beach or when skiing.
- When the background is overly dark or the subject light.

1 Set the Power Switch to "**MANUAL**" while pressing down the Lock Button located on the switch.

2 Press the **MENU/BRIGHT** wheel in. The Menu Screen appears.

3 Rotate the **MENU/BRIGHT** wheel to select "**EXPOSURE**", then press it.

4 Rotate the **MENU/BRIGHT** wheel to select "**MANUAL**", then press it. The Menu Screen disappears. The exposure control indicator appears.



5 Rotate the **MENU/BRIGHT** wheel towards "+" to brighten the image, or towards "-" to darken the image. (maximum ±6)

6 Press the **MENU/BRIGHT** wheel in. Exposure adjustment is complete.

To Return To Automatic Exposure Control . . .



..... select "**AUTO**" in step 4. Or, set the Power Switch to "**AUTO**".

To Brighten The Subject Quickly . . .

..... press **BACKLIGHT**.  is displayed and the subject is brightened. If pressed again,  disappears and the brightness returns to the previous level.

- +3 exposure has the same effect as the **BACKLIGHT** Button.
- Using **BACKLIGHT** may cause the light around the subject to become too bright and the subject to become white.
- Backlight compensations is also available when the Power Switch is set to "**AUTO**".

NOTE:

You cannot use the manual exposure control at the same time with backlight, spotlight ( pg. 25) compensation and "**SNOW**" ( pg. 25).

Iris Lock

Use this function in the following situations:

- When shooting a moving subject.
- When the distance to the subject changes (so its size in the LCD monitor or the viewfinder changes), such as when the subject is backing away.
- When shooting on a reflective natural background such as at the beach or when skiing.
- When shooting objects under a spotlight.
- When zooming.

When the subject is close, keep the iris locked. Even when the subject moves away from you, the image will not darken or brighten.

Before the following steps, perform steps 1 through 4 of "Exposure Control".

5 Adjust zoom so that the subject fills the LCD monitor or the viewfinder, then press and hold the **MENU/BRIGHT** wheel for over 2 seconds. The exposure control indicator and "**I**" appear. Press the **MENU/BRIGHT** wheel in. "**I**" changes to "**L**" and the iris is locked.

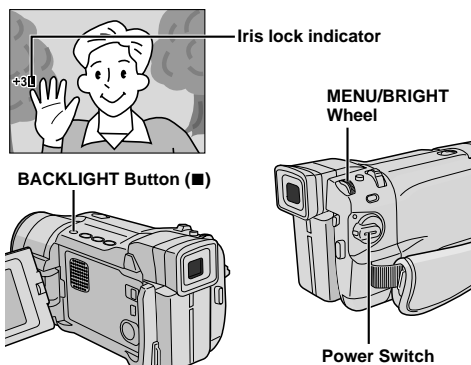

To Return To Automatic Iris Control . . .

..... rotate **MENU/BRIGHT** to display "**AUTO**" then press it in step 4. The exposure control indicator and "**I**" disappears. Or, set the Power switch to "**AUTO**".

To Lock The Exposure Control And The Iris . . .

..... after step 4 of "Exposure Control", adjust the exposure rotating the **MENU/BRIGHT** wheel. Then lock the iris in step 5 of "Iris Lock". For automatic locking, rotate the **MENU/BRIGHT** wheel to select "**AUTO**", then press it in step 4. The iris becomes automatic after about 2 seconds.

Iris

Like the pupil of the human eye, it contracts in well-lit environments to keep too much light from entering, and dilates in dim environments to allow in more light.

White Balance Adjustment

A term that refers to the correctness of colour reproduction under various lighting. If the white balance is correct, all other colours will be accurately reproduced.

The white balance is usually adjusted automatically. However, more advanced camcorder operators control this function manually to achieve a more professional colour/tint reproduction.

1 Set the Power Switch to "**MANUAL**" while pressing down the Lock Button located on the switch.

2 Press the **MENU/BRIGHT** wheel in. The Menu Screen appears.

3 Rotate the **MENU/BRIGHT** wheel to select "**W.BALANCE**", then press it. The **W.BALANCE** Menu appears.

4 Rotate the **MENU/BRIGHT** wheel to select the desired mode.

"**AUTO**" White balance is adjusted automatically (factory preset).

"**MWB**" White balance is set manually.

"**FINE**" Outdoors on a sunny day.

"**CLOUD**" Outdoors on a cloudy day.

"**HALOGEN**" ... A video light or similar type of lighting is used.

5 Press the **MENU/BRIGHT** wheel in. Selection is complete. Press the **MENU/BRIGHT** wheel in again. The Menu Screen closes and the selected mode indicator except "**AUTO**" appears.

To Return To Automatic White Balance . . .

..... select "**AUTO**" in step 4. Or, set the Power Switch to "**AUTO**".

NOTE:



White balance cannot be used when Sepia or Monotone (pg. 25) is activated.

Manual White Balance Operation

Perform Manual White Balance when shooting under various types of lighting.

1 Follow steps 1 through 4 of the white balance adjustment, and select "**MWB**".

2 Hold a sheet of plain white paper in front of the subject. Adjust zoom or position yourself so that the white paper fills the screen.

3 Press the **MENU/BRIGHT** wheel in until  begins blinking rapidly. When the setting is completed,  resumes normal blinking.

4 Press the **MENU/BRIGHT** wheel in twice. The Menu Screen closes and the Manual White Balance indicator  is displayed.

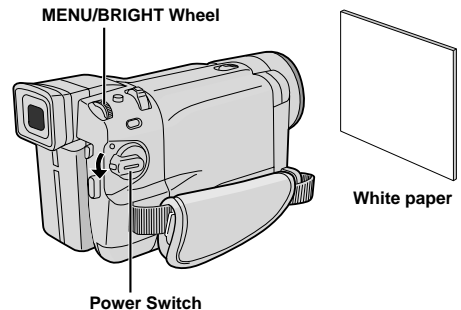

NOTES:

- In step 2, it may be difficult to focus on the white paper. In such a case, adjust focus manually (pg. 29).
- A subject can be shot under various types of lighting conditions indoors (natural, fluorescent, candlelight, etc.). Because the colour temperature is different depending on the light source, the subject tint will differ depending on the white balance settings. Use this function for a more natural result.
- Once you adjust white balance manually, the setting is retained even if the power is turned off or the battery removed.

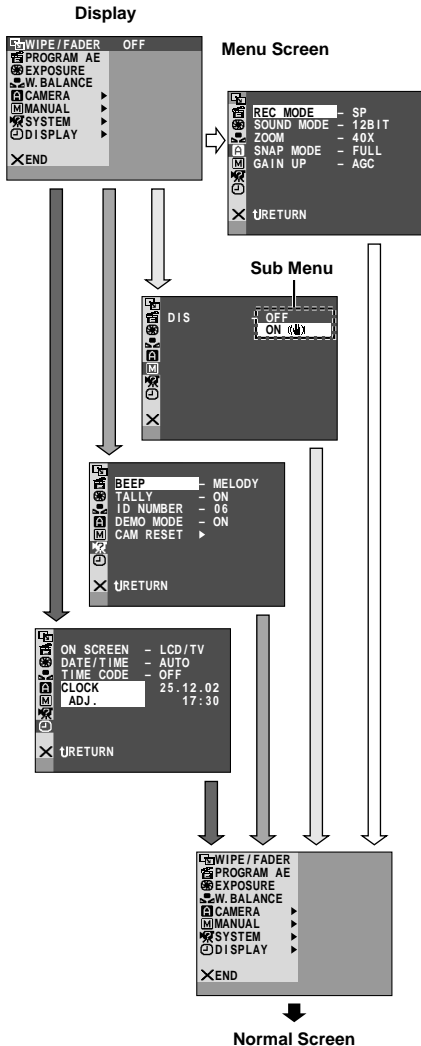
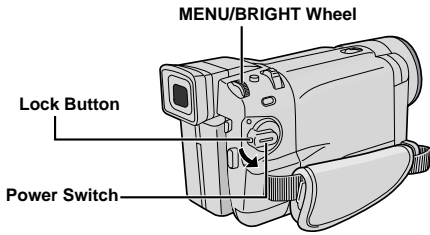

For Recording Menu

This camcorder is equipped with an easy-to-use, on-screen menu system that simplifies many of the more detailed camcorder settings (pg. 33 – 35).

- 1 Set the Power Switch to “**MANUAL**” while pressing down the Lock Button located on the switch.
- 2 Press the **MENU/BRIGHT** wheel in. The Menu Screen appears.
- 3 Rotate the **MENU/BRIGHT** wheel to select the desired function menu, and press it. The selected function menu appears.
- 4 Function menu setting depends on the function.

If you have selected “**WIPE/FADER**”, “**PROGRAM AE**”, “**EXPOSURE**” or “**W. BALANCE**” ...

..... see pg. 33.

If you have selected “**CAMERA**”, “**MANUAL**”, “**SYSTEM**” or “**DISPLAY**” ...

..... go to step 5.

5 Rotate the **MENU/BRIGHT** wheel to select the desired function and press it. The Sub Menu appears. Then, rotate the **MENU/BRIGHT** wheel to select the parameter, and press it. Selection is complete.









6 Rotate the **MENU/BRIGHT** wheel to select “**RETURN**” and press it twice. The Menu Screen closes.

• The **X** icon represents “**END**”.

NOTE:

When the Menu Screen is left on for a couple of minutes, a residual image may be left on the screen and it may take several seconds for the residual image to disappear. This is not due to any defect of the unit.

Menu Screen Explanations

| | | | | |
|---|-------------------|--|---|---|
|  | WIPE/FADER | | Refer to “Fade/Wipe Effects” (☞ pg. 26, 27). | |
|  | PROGRAM AE | | Refer to “Programme AE With Special Effects” (☞ pg. 24, 25). | |
|  | EXPOSURE | | Refer to “Exposure Control” and “Iris Lock” (☞ pg. 30). | |
|  | W.BALANCE | | Refer to “White Balance Adjustment” and “Manual White Balance Operation” (☞ pg. 31). | |
| CAMERA | REC MODE | | Allows you to set the tape recording mode (SP or LP) depending on your preference (☞ pg. 13). | |
| | SOUND MODE | 12BIT | Enables tape recording of stereo sound on four separate channels, and is recommended for use when performing audio dubbing. (Equivalent to the 32 kHz mode of previous models) | |
| | | 16BIT | Enables tape recording of stereo sound on two separate channels. (Equivalent to the 48 kHz mode of previous models) | |
| | ZOOM | 10X | When set to “10X” while using digital zoom, the zoom magnification will reset to 10X since digital zoom will be disengaged. | |
| | | 40X | Allows you to use the Digital Zoom. By digitally processing and magnifying images, zooming is possible from 10X (the optical zoom limit), to a maximum of 40X digital magnification. | |
| | | 500X | Allows you to use the Digital Zoom. By digitally processing and magnifying images, zooming is possible from 10X (the optical zoom limit), to a maximum of 500X digital magnification. | |
| | SNAP MODE | | Refer to “Snapshot” (☞ pg. 28). | |
| | GAIN UP | OFF | | Allows you to shoot dark scenes with no picture brightness adjustment. |
| | | AGC | | The overall appearance may be grainy, but the image is bright. |
| | | AUTO  | | The shutter speed is automatically adjusted (1/25 — 1/200 sec.). Shooting a subject in low or poor lighting at 1/25 sec. shutter speed provides a brighter image than in the AGC mode, but the subject's movements are not smooth or natural. The overall appearance may be grainy. While the shutter speed is being automatically adjusted, “  A” is displayed. |
| MANUAL | DIS | OFF | To compensate for unstable images caused by camera-shake, particularly at high magnification. NOTES: <ul style="list-style-type: none"> • Accurate stabilisation may not be possible if hand shake is excessive, or under the following conditions: <ul style="list-style-type: none"> • When shooting subjects with vertical or horizontal stripes. • When shooting dark or dim subjects. • When shooting subjects with excessive backlighting. • When shooting scenes with movement in various directions. • When shooting scenes with low-contrast backgrounds. • Switch off this mode when recording with the camcorder on a tripod. • The “” indicator blinks or goes out if the Stabiliser cannot be used. | |
| | | ON  | | |



 : Factory-preset

NOTES:

- Settings made in the “**CAMERA**” Menu remain effective whether the Power Switch is set to “**AUTO**” or “**MANUAL**”. However, the menu settings can be changed only when the Power Switch is set to “**MANUAL**”.
- The “**MANUAL**” settings are effective only when the Power Switch is set to “**MANUAL**”.





CONTINUED ON NEXT PAGE

Menu Screen Explanations (cont.)

| | | | |
|--|------------|--|---|
| MANUAL | TELE MACRO | OFF | Usually the distance to a subject where the lens is in focus depends on the zoom magnification. Unless there is a distance more than 1m to the subject, the lens is out of focus at the maximum telephoto setting. When set to "ON", you can shoot a subject as large as possible at a distance of approx. 60 cm. • Depending on the zoom position, the lens may go out of focus. |
| | | ON | |
| | WIDE MODE | OFF | Records with no change in the screen ratio. For playback on a TV with a normal screen ratio. |
| | | CINEMA <input type="checkbox"/> | Inserts black bands at the top and bottom of the screen. During playback on wide-screen TVs, the black bands at the top and bottom of the screen are cut and the screen ratio becomes 16:9. <input type="checkbox"/> appears. When using this mode, refer to your wide-screen TV's instruction manual. During playback/recording on 4:3 TVs/LCD monitor/viewfinder, black bands are inserted at the top and bottom of the screen and the image appears like a letterboxed 16:9 movie. |
| | | SQUEEZE <input checked="" type="checkbox"/> | For playback on TVs with an aspect ratio of 16:9. Naturally expands the image to fit the screen without distortion. <input checked="" type="checkbox"/> appears. When using this mode, refer to your wide-screen TV's instruction manual. During playback/recording on 4:3 TVs/LCD monitor/viewfinder, the image is elongated vertically. |
| | WIND CUT | OFF | Disengages the function which cuts down on noise created by wind. |
| ON  | | Helps cut down on noise created by wind. "  | |
| SYSTEM | BEEP | OFF | Even though not heard while shooting, shutter sound is recorded on the tape. |
| | | BEEP | The beep sounds when the power is turned on or off, and at the beginning and end of recording. Also to activate the shutter sound effect (ⓘ pg. 28). |
| | | MELODY | Instead of a beep, a melody sounds when any operation is performed. It also activates the shutter sound effect (ⓘ pg. 28). |
| | TALLY | OFF | The tally lamp remains off at all times. |
| | | ON | The tally lamp comes on to signal the start of recording. |
| ID NUMBER | | This number is necessary when connecting the camcorder to a device such as a computer using the J terminal (JLIP) or PC connector. The numbers range from 01 to 99. Factory setting is 06. | |

 : Factory-preset

NOTES:

- The " MANUAL" settings are effective only when the Power Switch is set to "".
- " SYSTEM" functions which are set when the Power Switch is set to "" are also applied when the Power Switch is set to "PLAY" (ⓘ pg. 36)

| | | | |
|-------------------|------------------|---|--|
| SYSTEM | DEMO MODE | OFF | Automatic demonstration will not take place. |
| | | ON | <p>Demonstrates certain functions such as Programme AE with special effects, etc., and can be used to confirm how these functions operate. Demonstration starts in the following cases:</p> <ul style="list-style-type: none"> • When the Menu Screen is closed after "DEMO MODE" is turned "ON". • With "DEMO MODE" set to "ON", if there is no operation for about 3 minutes after the Power Switch is set to "AUTO" or "MANUAL". <p>Performing any operation during the demonstration stops the demonstration temporarily. If no operation is performed for more than 3 minutes after that, the demonstration will resume.</p> <p>NOTES:</p> <ul style="list-style-type: none"> • If a tape is in the camcorder, the demonstration cannot be turned on. • "DEMO MODE" remains "ON" even if the camcorder power is turned off. • If "DEMO MODE" remains "ON", some functions will not be available. After viewing demo, set to "OFF". |
| | CAM RESET | CANCEL | Does not reset all settings to the factory-preset. |
| | | EXECUTE | Resets all settings to the factory-preset. |
| DISPLAY | ON SCREEN | LCD | Keeps the camcorder's display (except the date, time and time code) from appearing on the connected TV screen. |
| | | LCD/TV | Makes the camcorder's display appear on screen when the camcorder is connected to a TV. |
| | DATE/TIME | OFF | The date/time does not appear. |
| | | AUTO | <p>Displays the date/time for approx. 5 seconds in the following cases:</p> <ul style="list-style-type: none"> • When the Power Switch is set from "OFF" to "AUTO" or "MANUAL". • When tape playback starts. The camcorder displays the date/time when scenes are recorded. • When the date is changed during tape playback. |
| | | ON | The date/time is always displayed. |
| | TIME CODE | OFF | Time code is not displayed. |
| | | ON | Time code is displayed on the camcorder and on the connected TV. Frame numbers are not displayed during recording. |
| CLOCK ADJ. | | Allows you to set the current date and time (pg. 11). | |

 : Factory-preset

NOTES:

- "SYSTEM" and "DISPLAY" functions which are set when the Power Switch is set to "**MANUAL**" are also applied when the Power Switch is set to "PLAY" (pg. 36). "CLOCK ADJ." only appears when the Power Switch is set to "**MANUAL**".
- Settings made in the "DISPLAY" Menu remain effective even when the Power Switch is set to "**AUTO**". However, the menu settings can be changed only when the Power Switch is set to "**MANUAL**".

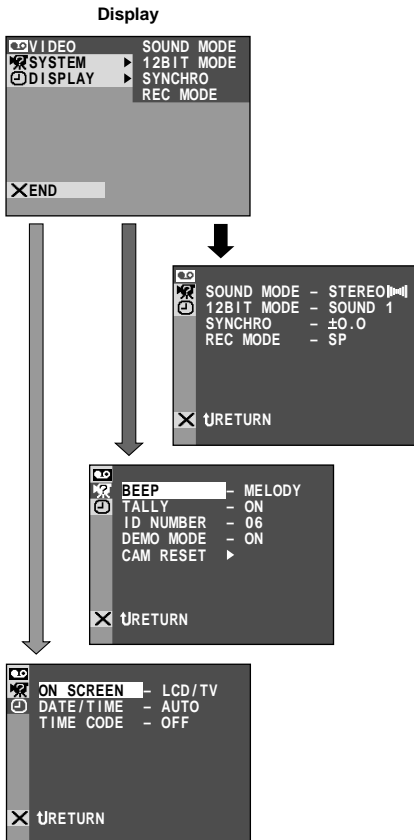
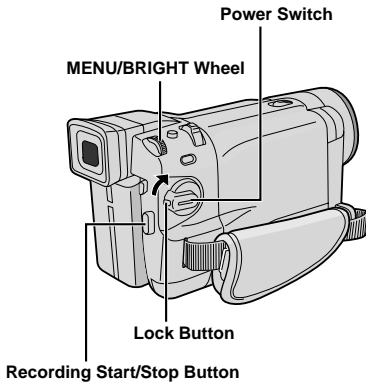

For Playback Menu

The following procedure applies to all except Synchro Comp (pg. 47).

- 1** Set the Power Switch to "PLAY" while pressing down the Lock Button located on the switch.
- 2** Press the MENU/BRIGHT wheel in. The Menu Screen appears.
- 3** Rotate the MENU/BRIGHT wheel to select the desired function menu, and press it. The selected function menu appears.
- 4** Rotate the MENU/BRIGHT wheel to select the desired function, and press it to display the Sub Menu.
- 5** Rotate the MENU/BRIGHT wheel to select the desired parameter and press it. Selection is complete.
- 6** Rotate the MENU/BRIGHT wheel to select "RETURN" and press it twice to close the Menu Screen.

Menu Screen Explanations



| | | |
|---------|--|---|
| VIDEO | SOUND MODE | pg. 37. |
| | 12BIT MODE | pg. 37. |
| | SYNCHRO | pg. 47. |
| | REC MODE | Allows you to set the tape recording mode (SP or LP) depending on your preference (pg. 13). |
| SYSTEM | Each setting is linked with "DISPLAY" or "SYSTEM", which appears when the Power Switch is set to "MANUAL" (pg. 34, 35). The parameters are the same as in the description on pg. 34, 35. | |
| DISPLAY | | |

NOTE:

"REC MODE" can be set when the Power Switch is set to "PLAY" or "MANUAL" (pg. 13, 33).

Playback Sound

During tape playback, the camcorder detects the sound mode in which the recording was made, and plays the sound back. Select the type of sound to accompany your playback picture. According to the menu access explanation on pg. 36, select "SOUND MODE" or "12BIT MODE" from the Menu Screen and set it to the desired parameter.



| | | |
|------------|---|--|
| SOUND MODE | STEREO  | Sound is output on both "L" and "R" channels in stereo. |
| | SOUND L  | Sound from the "L" channel is output in stereo. |
| | SOUND R  | Sound from the "R" channel is output in stereo. |
| 12BIT MODE | MIX | Original and dubbed sounds are combined and output in stereo on both "L" and "R" channels in stereo. |
| | SOUND 1 | Original sound is output on both "L" and "R" channels in stereo. |
| | SOUND 2 | Dubbed sound is output on both "L" and "R" channels in stereo. |

 : Factory-preset

NOTES:

- The "SOUND MODE" setting is available for both 12-bit and 16-bit sound. (In previous models' functions, "12-bit" is called "32 kHz" and "16-bit" is called "48 kHz".)
- The camcorder cannot detect the sound mode in which the recording was made during fast-forward or rewind. During playback the sound mode is displayed in the upper left corner.

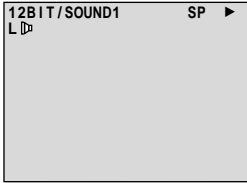
Display

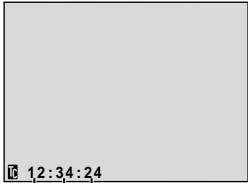
| | | |
|--|--|--|
| <p>ON SCREEN setting: For playback sound, tape speed and tape running.</p>  | <p>DATE/TIME setting: For date/time.</p>  | <p>TIME CODE setting: For time code.</p>  <p>Minutes Seconds Frames*</p> <p>*25 frames = 1 second</p> |
|--|--|--|

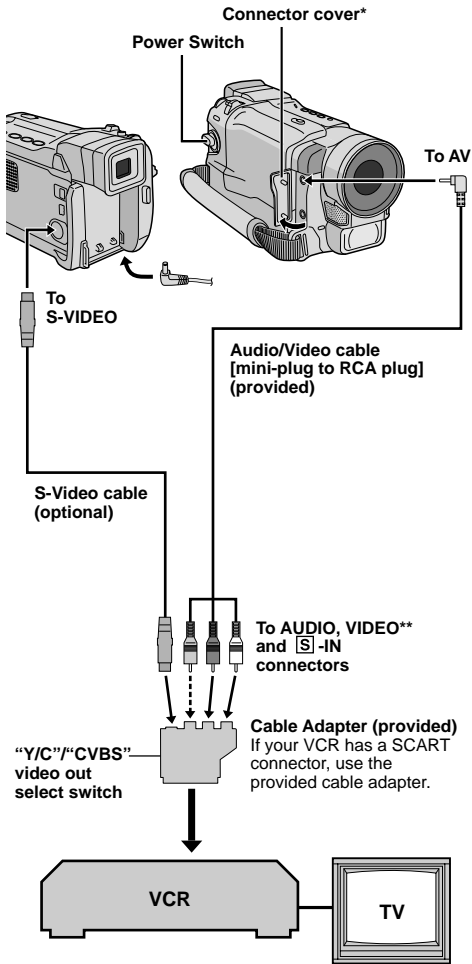

* When connecting the cables, open this cover.

** Connect when an S-Video cable is not used.

Dubbing To A VCR

- 1** Following the illustration, connect the camcorder and the VCR. Also refer to pg. 20 and 21.
- 2** Set the camcorder's Power Switch to "PLAY" while pressing down the Lock Button located on the switch, turn on the VCR's power, and insert the appropriate cassettes in the camcorder and the VCR.
- 3** Engage the VCR's AUX and Record-Pause modes.
- 4** Engage the camcorder's Play mode to find a spot just before the edit-in point. Once it is reached, press ►/|| on the camcorder.
- 5** Press ►/|| on the camcorder and engage the VCR's Record mode.
- 6** Engage the VCR's Record-Pause mode and press ►/|| on the camcorder.
- 7** Repeat steps 4 through 6 for additional editing, then stop the VCR and camcorder when finished.

NOTES:

- As the camcorder starts to play your footage it will appear on your TV. This will confirm the connections and the AUX channel for dubbing purposes.
- Before you start dubbing, make sure that the indications do not appear on the connected TV. If they do, they are being recorded onto the new tape.
- Set the video out select switch of the cable adapter as required:
 - Y/C : When connecting to a TV or VCR which accepts Y/C signals and uses an S-Video cable.
 - CVBS : When connecting to a TV or VCR which does not accept Y/C signals and uses an audio/video cable.

To choose whether or not the following displays appear on the connected TV . . .

- Date/Time
 - set "DATE/TIME" to "AUTO", "ON" or "OFF" in the Menu Screen (☞ pg. 36).
- Time Code
 - set "TIME CODE" to "ON" or "OFF" in the Menu Screen (☞ pg. 36).
- Playback Sound Mode, Tape Speed And Tape Running Displays
 - set "ON SCREEN" to "LCD" or "LCD/TV" in the Menu Screen (☞ pg. 36).

Dubbing To A Video Unit Equipped With A DV Connector (Digital Dubbing)

It is also possible to copy recorded scenes from this camcorder onto another video unit equipped with a DV connector. Since a digital signal is sent, there is little if any image or sound deterioration.

[To use this camcorder as a player]

- 1** Make sure all units are turned off. Connect this camcorder to a video unit equipped with a DV input connector using a DV cable as shown in the illustration.
- 2** Set this camcorder's Power Switch to "PLAY" while pressing down the Lock Button located on the switch, turn on the video unit's power, and insert the appropriate cassettes in this camcorder and the video unit.
- 3** Press ► to play back the source tape.
- 4** While watching the playback on the monitor, engage the DV connector-equipped video unit's record mode from the spot on the source tape you want to begin recording.

NOTES:

- It is recommended to use the AC Adapter as the power supply instead of the battery pack (▶ pg. 9).
- If the remote control is used when both the player and recorder are JVC video units, both units will perform the same operation. To prevent this from happening, press the buttons on both units.
- If a blank portion or disturbed image is played back on the player during dubbing, the dubbing may stop so that an unusual image is not dubbed.
- Even though the DV cable is connected correctly, sometimes the image may not appear in step 4. If this occurs, turn off the power and make connections again.
- If "Playback Zoom" (▶ pg. 42) or "Snapshot" is attempted during playback, only the original playback image recorded on the tape is output from the DV connector.
- When using a DV cable, be sure to use the optional JVC VC-VDV204U DV cable.

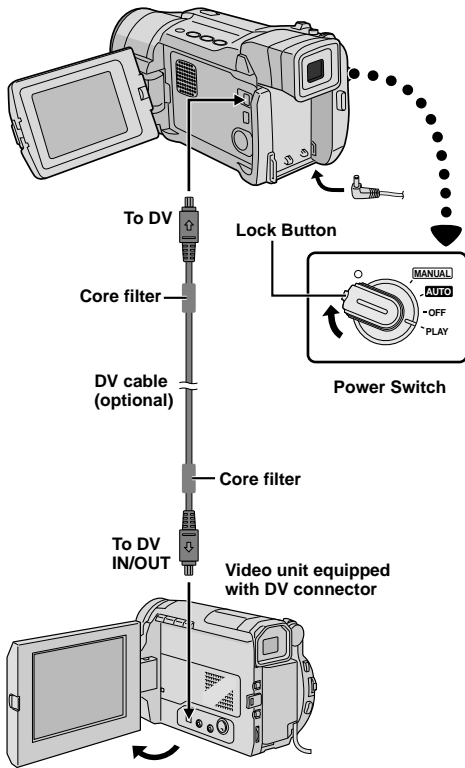

The Full-Function Remote Control Unit can operate this camcorder from a distance as well as the basic operations (Playback, Stop, Pause, Fast-Forward and Rewind) of your VCR. It also makes additional playback functions possible.

Installing The Battery (RM-V700U, optional)

The remote control uses one lithium battery (CR2025).

1 There are 2 ways to pull the battery holder out of the RM-V700U.

(A) : Pull out the battery holder while sliding the lock hole.

(B) : Pinch the release tab and pull out the battery holder.

2 Insert the battery in the holder, and be sure to have the "+" mark visible.

3 Slide the holder back in until you hear a click.
• Read the caution concerning lithium batteries in the RM-V700U instruction manual.

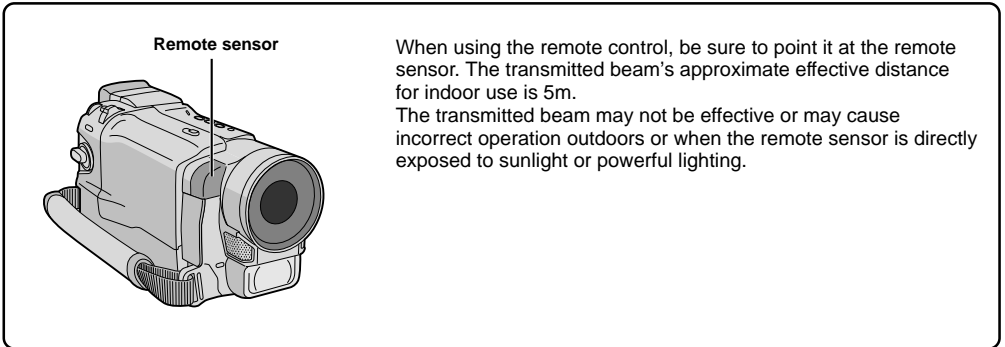
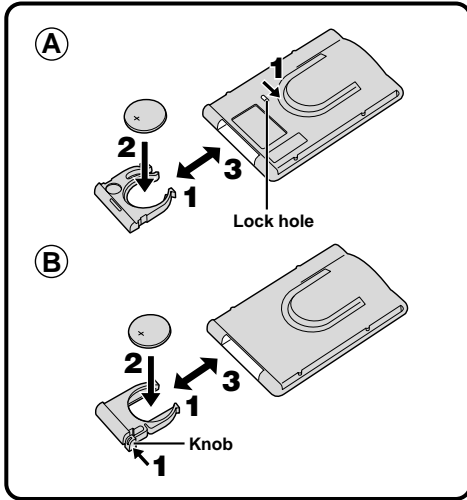

When using the remote control, be sure to point it at the remote sensor. The transmitted beam's approximate effective distance for indoor use is 5m.

The transmitted beam may not be effective or may cause incorrect operation outdoors or when the remote sensor is directly exposed to sunlight or powerful lighting.

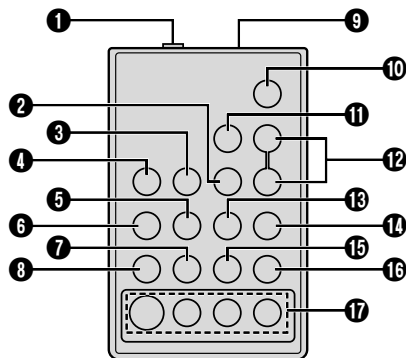

RM-V700U
(optional)

| Buttons | Functions | |
|---|--|--|
| | With the camcorder's Power Switch set to the camera position ("AUTO" or "MANUAL"). | With the camcorder's Power Switch set to "PLAY". |
| ① PAUSE IN Connector | — | ☞ pg. 44 |
| ② MBR SET Button | — | ☞ pg. 43 |
| ③ INT. TIME Button* SELF TIMER Button* | — | |
| ④ REC TIME Button* ANIM. Button* | — | |
| ⑤ FF Button | — | Forward, Forward Shuttle Search (☞ pg. 19) |
| ⑥ REW Button | — | Rewind, Reverse Shuttle Search (☞ pg. 19) |
| ⑦ PAUSE Button | — | Pause (☞ pg. 19) |
| ⑧ PLAY Button | — | Playback start (☞ pg. 19) |
| ⑨ Infrared beam transmitting window | Transmits the beam signal. | |
| ⑩ START/STOP Button | Functions the same as the Recording Start/Stop Button on the camcorder. | |
| ⑪ VISS Button* | — | |
| ⑫ ZOOM (T/W) Buttons | Zoom in/out (☞ pg. 17) | Zoom in/out (☞ pg. 42) |
| ⑬ VCR CTL Button | — | ☞ pg. 43 |
| ⑭ A.DUB Button | — | ☞ pg. 48 |
| ⑮ STOP Button | — | Stops (☞ pg. 19) |
| ⑯ INSERT Button | — | ☞ pg. 49 |
| ⑰ R.A.EDIT Buttons | — | ☞ pg. 43 – 47 |

* This function is unavailable with this camcorder.

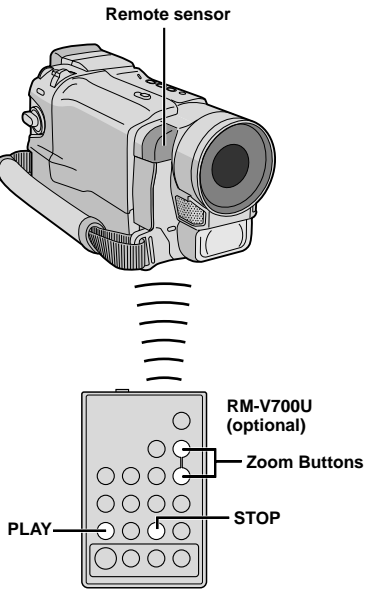
**FEATURE: Playback Zoom****PURPOSE:**

To magnify the recorded image up to 50X at any time during playback.

OPERATION:

- 1) Press **PLAY** (▶) to find the scene of interest.
- 2) Press the Zoom Buttons (**T/W**) on the remote control. Make sure the remote control is pointed at the camcorder's remote sensor. Pressing **T** zooms in.
 - To end zoom, press and hold **W** until magnification returns to normal. Or, press **STOP** (■) and then press **PLAY** (▶).

NOTES:

- Zoom can also be used during still playback.
- Due to digital image processing, the quality of the image may suffer.



Normal playback



Press T

Random Assemble Editing [R.A.Edit]

Create edited videos easily using your camcorder as the source player. You can select up to 8 "cuts" for automatic editing, in any order you like. R.A.Edit is more easily performed when the MBR (Multi-Brand Remote) is set to operate with your brand of VCR (see VCR CODE LIST), but can also be performed by operating the VCR manually.

Use the optional RM-V700U remote control.

Before operation, make sure the lithium battery is installed in the remote control (see pg. 40).

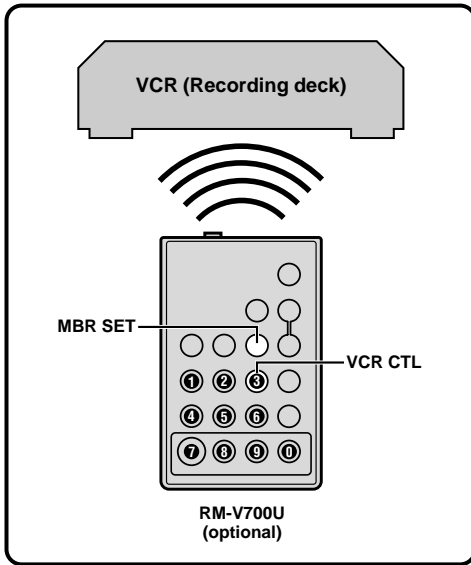

SET REMOTE/VCR CODE

1 Turn off the power to the VCR and point the remote towards the VCR's infrared sensor. Then, referring to the VCR CODE LIST, press and hold **MBR SET**, and enter the brand code. The code is automatically set once you release **MBR SET**, and the VCR's power comes on.

2 Make sure the VCR's power is on. Then, while holding **VCR CTL**, press the button on the remote for the desired function. The functions the remote can control are PLAY, STOP, PAUSE, FF, REW and VCR REC STBY (you do not need to press **VCR CTL** for this one).

You are now ready to try Random Assemble Editing.

IMPORTANT

Although the MBR is compatible with JVC VCRs and those of many other makers, it may not work with yours or may offer limited functions.

NOTES:

- If the VCR's power does not come on in step 1, try another code from the VCR CODE LIST.
- Some brands of VCR do not come on automatically. In this case, turn the power on manually and try step 2.
- If the remote control is not able to control the VCR, use the controls on the VCR.
- When the remote control's batteries run out, the VCR brand you have set will be erased. In that case, replace the old battery with a new one to reset the VCR brand.

VCR CODE LIST

| VCR BRAND NAME | BRAND CODE | VCR BRAND NAME | BRAND CODE |
|-----------------|---------------------------------|---|---|
| AKAI | 6 2 6 4 7 7 | PHILIPS | 1 9 9 5 1 1 9 4 9 1 9 6 1 2 3 3 7 2 |
| BLAUPUNKT | 1 3 | SANYO | 3 6 3 5 |
| FERGUSON | 9 7 9 8 3 2 | SELECO, REX | 9 1 9 6 |
| GRUNDIG | 1 4 3 4 | SHARP | 1 5 1 0 |
| HITACHI | 6 6 6 3 | SONY | 6 5 6 0 3 9 3 1 |
| JVC A B C | 9 1 9 6 9 3 | THOMSON, TELEFUNKEN, SABA, NORDMENDE | 9 1 9 6 9 7 3 2 |
| MITSUBISHI | 6 7 6 8 | TOSHIBA | 6 9 6 1 |
| NEC | 3 7 3 8 | | |
| PANASONIC | 1 3 1 7 1 1 9 4 1 8 | | |

CONTINUED ON NEXT PAGE

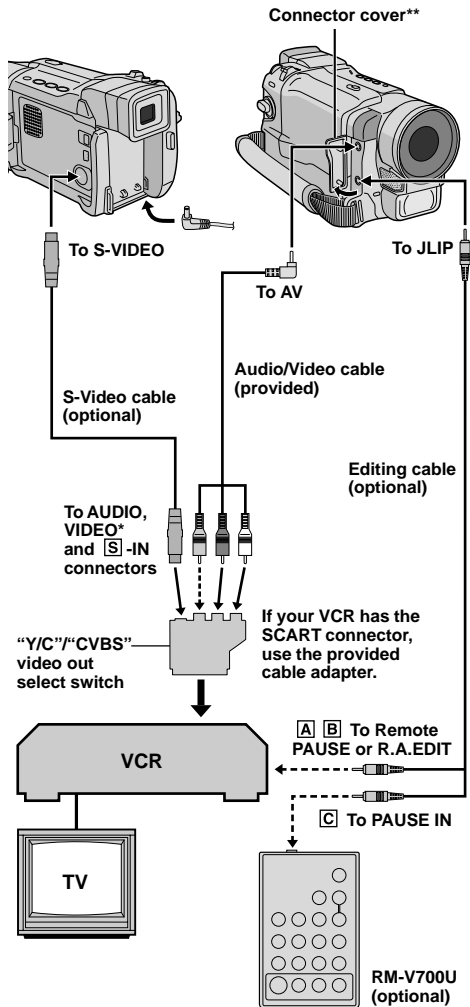

* Connect when an S-Video cable is not used.

** When connecting cables, open this cover.

MAKE CONNECTIONS

Also refer to pg. 20 and 21.

1 A JVC VCR equipped with a remote pause connector . . .

..... connect the editing cable to the Remote PAUSE connector.

B A JVC VCR not equipped with a remote pause connector but equipped with an R.A.EDIT connector . . .

..... connect the editing cable to the R.A.EDIT connector.

C A VCR other than above . . .

..... connect the editing cable to the remote control's PAUSE IN connector.

2 Insert a recorded tape into the camcorder. Set the Power Switch to "PLAY" while pressing down the Lock Button located on the switch.

3 Turn the VCR power on, insert a recordable tape and engage the AUX mode (refer to the VCR's instructions).

NOTES:

- Before Random Assemble Editing, make sure the indications do not appear on the TV monitor. If they do, they will be recorded onto the new tape.

To choose whether or not the following displays appear on the connected TV . . .

- Date/Time
 - set "DATE/TIME" to "AUTO", "ON" or "OFF" in the Menu Screen (☞ pg. 36).
- Time Code
 - set "TIME CODE" to "ON" or "OFF" in the Menu Screen (☞ pg. 36).
- Playback Sound Mode, Tape Speed And Tape Running Displays
 - set "ON SCREEN" to "LCD" or "LCD/TV" in the Menu Screen (☞ pg. 36).
- Set the video out select switch of the cable adapter as required:
 - Y/C : When connecting to a TV or VCR which accepts Y/C signals and uses an S-Video cable.
 - CVBS : When connecting to a TV or VCR which does not accept Y/C signals and uses an audio/video cable.
- When editing on a VCR equipped with a DV input connector, an optional DV cable can be connected instead of an S-Video cable and audio/video cable.

ATTENTION FOR EDITING CABLE

- Make sure you use the optional editing cable QAM0214-001. Consult the JVC Service Center for details on its availability.
- Make sure you connect the end with the core filter (plug which has 3 rings around the pin) to the camcorder.

Programme

| | IN | OUT | MODE |
|-----------|----|-----|-------|
| 1 | -- | -- | -- |
| 2 | -- | -- | -- |
| 3 | -- | -- | -- |
| 4 | -- | -- | -- |
| 5 | -- | -- | -- |
| 6 | -- | -- | -- |
| 7 | -- | -- | -- |
| 8 | -- | -- | -- |
| TIME CODE | | | --:-- |
| TOTAL | | | 00:00 |

Random Assemble
Editing Menu

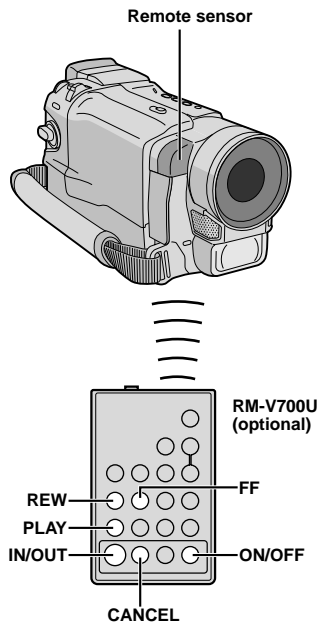

SELECT SCENES

4 Point the remote control at the camcorder's remote sensor. Press **PLAY** (▶) and then press **ON/OFF** on the remote control. The Random Assemble Editing Menu appears.

5 At the beginning of the scene, press **IN/OUT** on the remote control. The Edit-In position appears in the Random Assemble Editing Menu.

6 At the end of the scene, press **IN/OUT**. The Edit-Out position appears in the Random Assemble Editing Menu.

7 Repeat steps 5 and 6 to register additional scenes.

- To change previously registered points, press **CANCEL** on the remote control. The registered points disappear, one at a time, from the most recently registered point.

NOTES:

- When choosing a scene, set Edit-In and Edit-Out points so that there is a relatively large difference between them.
- If the search time for an in-point exceeds 5 minutes, the recording deck's Record-Standby mode will be cancelled and editing will not take place.
- If there are blank portions before or after the Edit-In and Edit-Out points, a blue screen may be included in the edited version.
- Since time codes register time only as accurately as seconds, the time code total time may not match the total programme time exactly.
- Turning off the camcorder's power erases all registered Edit-In and Edit-Out points.

CONTINUED ON NEXT PAGE

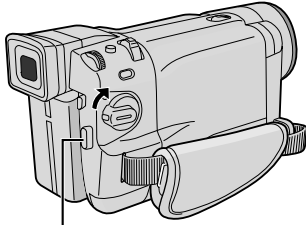

Recording Start/Stop Button

| | IN | OUT | MODE |
|-----------|-------|-------|------|
| 1-- | 00:25 | 02:05 | -- |
| 2-- | 07:18 | 08:31 | -- |
| 3-- | 03:33 | 05:53 | -- |
| 4-- | 09:30 | 13:15 | -- |
| 5-- | 15:55 | 16:29 | -- |
| 6-- | | | |
| 7 | | | |
| 8 | | | |
| TIME CODE | | 16:30 | |
| TOTAL | | 9:39 | |

Random Assemble Editing Menu

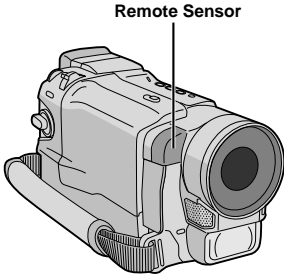

Remote Sensor

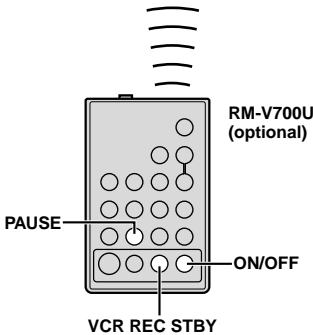

AUTOMATIC EDITING TO VCR

8 Rewind the tape in the camcorder to the beginning of the scene you want to edit and press **PAUSE (II)**.

9 Point the remote control towards the VCR's remote sensor and press **VCR REC STBY (●III)**, or manually engage the VCR's Record-Pause mode.

10 Press the Recording Start/Stop Button on the camcorder. Editing proceeds as programmed, right through to the end of the last registered scene.

- When dubbing is complete, the camcorder enters the Pause mode, and the VCR enters its Record-Pause mode.
- If you do not register an Edit-Out point, the tape will be dubbed all the way to the end automatically.
- If you operate the camcorder during automatic editing, the VCR will enter its Record-Pause mode and automatic editing will stop.

11 Engage the Stop modes for the camcorder and the VCR.

To make the R.A.Edit counter display disappear, press **ON/OFF** on the remote control.

NOTES:

- Pressing **ON/OFF** on the remote control clears all settings registered during Random Assemble Editing.
- When the editing cable is connected to the remote control's Pause In connector during dubbing, make sure the remote control is pointed at the VCR's sensor, and the path between the two is unobstructed.
- Random Assemble Editing may not function properly when using a tape including several duplicated time codes (☞ pg. 18).

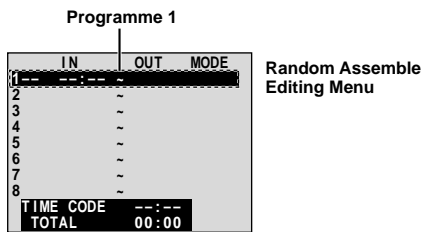

Random Assemble Editing Menu

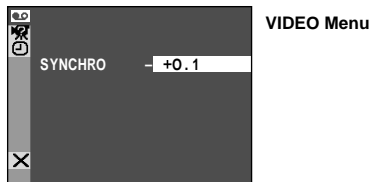

VIDEO Menu

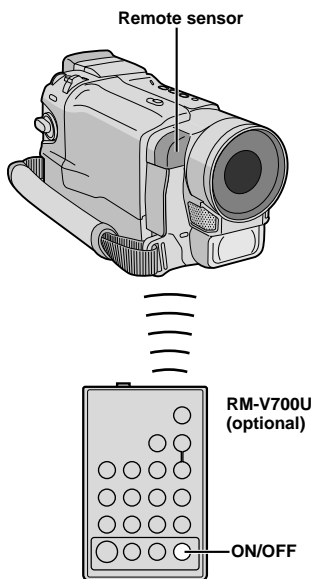

For More Accurate Editing

Some VCRs make the transition from Record-Pause to Record mode faster than others. Even if you begin editing for the camcorder and the VCR at exactly the same time, you may lose scenes you wanted, or find that you have recorded scenes you did not want. For a cleanly edited tape, confirm and adjust the timing of the camcorder against your VCR.

DIAGNOSING VCR/CAMCORDER TIMING

- 1 Play back the tape in the camcorder, then point the remote control at the camcorder's remote sensor and press **ON/OFF**. The Random Assemble Editing Menu appears.
- 2 Perform Random Assemble Editing on Programme 1 only. In order to check VCR and camcorder timing, select the beginning of a scene transition as your Edit-In point.
- 3 Play back the dubbed scene.
 - If any images from the scene prior to the transition you chose for your Edit-In point were recorded, that means your VCR moves too quickly from Record-Pause to Record mode.
 - If the scene you tried to dub starts in progress, the VCR is slow to start recording.

ADJUSTMENT OF VCR/CAMCORDER TIMING

- 4 Point the remote control at the camcorder's remote sensor and press **ON/OFF** to make the Random Assemble Editing menu disappear, then press the **MENU/BRIGHT** wheel in. The Menu Screen appears.
- 5 Rotate the **MENU/BRIGHT** wheel to select "VIDEO" and press it. The VIDEO Menu appears. Then, rotate it to "SYNCHRO" and press it. The value for "SYNCHRO" is highlighted.
- 6 Based on the diagnostics performed, you can now advance the VCR's record timing by rotating the **MENU/BRIGHT** wheel towards "+". You can also delay the VCR's record timing by rotating the **MENU/BRIGHT** wheel towards "-". The adjustment range is from -1.3 to +1.3 seconds, in 0.1-second increments. Press the **MENU/BRIGHT** wheel in to finish the setting.
- 7 Rotate the **MENU/BRIGHT** wheel to select "RETURN" and press it twice. Now perform Random Assemble Editing beginning with step 4 on page 45.

NOTES:

- Before performing actual Random Assemble Editing, do a few Random Assemble Editing trial runs to check whether the value you have input is appropriate or not, and make adjustments accordingly.
- Depending on the recorder, there may be situations where the timing difference cannot be fully corrected.

Display

Audio Dub
Standby mode

Power Switch

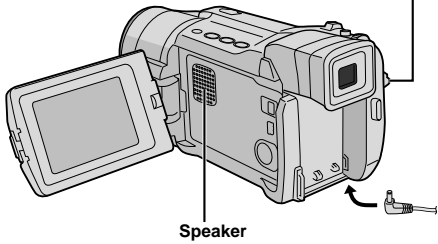

Speaker

Remote sensor

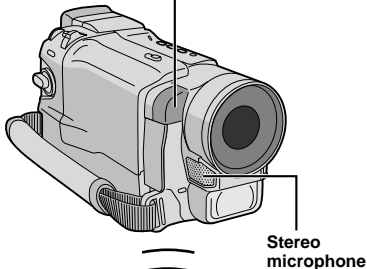
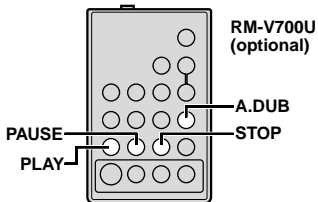
Stereo
microphoneRM-V700U
(optional)

A.DUB

STOP

PAUSE

PLAY

Audio Dubbing

The audio track can be customized only when recorded in the 12-bit mode (☞ pg. 33).

NOTES:

- Audio Dubbing is not possible on a tape recorded in 16-bit audio, on a tape recorded in the LP mode or on a blank portion of a tape.
- To perform Audio Dubbing while watching on the television, make connections (☞ pg. 20).

1 Play back the tape to locate the point where editing will start, then press **PAUSE** (⏸).

2 While holding **A.DUB** (Ⓜ) on the remote control, press **PAUSE** (⏸). "II" appears.

3 Press **PLAY** (▶), then begin "narrating". Speak into the microphone.

- To pause dubbing, press **PAUSE** (⏸).

4 To end Audio Dubbing, press **PAUSE** (⏸), then **STOP** (■).

To hear the dubbed sound during playback . . .

..... set "12BIT MODE" to "SOUND 2" or "MIX" in the Menu Screen (☞ pg. 36, 37).

NOTES:

- Sound is not heard from the speaker during Audio Dubbing.
- When editing onto a tape that was recorded at 12-bit, the old and new soundtracks are recorded separately.
- If you dub onto a blank space on the tape, the sound may be disrupted. Make sure you only edit recorded areas.
- If feedback or howling occurs during TV playback, move the camcorder's microphone away from the TV, or turn down the TV's volume.
- If you change from 12-bit to 16-bit in mid-recording and then use the tape for Audio Dubbing, it is not effective from the point where 16-bit recording began.
- During Audio Dubbing, when the tape moves to scenes recorded in the LP mode, scenes recorded in 16-bit audio or a blank portion, Audio Dubbing stops (☞ pg. 66).

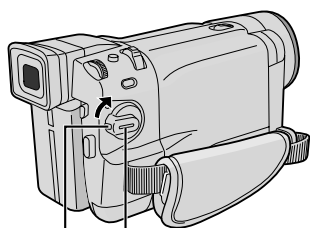

Power Switch

Lock Button

Display

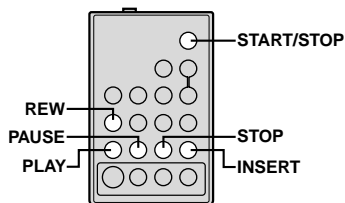
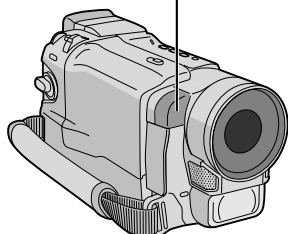

Remote sensor

RM-V700U
(optional)

Insert Editing

You can record a new scene into a previously recorded tape, replacing a section of the original recording with minimal picture distortion at the in and outpoints. The original audio remains unchanged.

NOTES:

- Before performing the following steps, make sure that "TIME CODE" is set to "ON" in the Menu Screen (☞ pg. 35, 37).
- Insert Editing is not possible on a tape recorded in the LP mode or on a blank portion of a tape.
- To perform Insert Editing while watching in the television, make connections (☞ pg. 20).

1 Play back the tape, locate the Edit-Out point and press **PAUSE (II)**. Confirm the time code at this point (☞ pg. 35, 37).

2 Press **REW (◀)** until the Edit-In point is located, then press **PAUSE (II)**.

3 Press and hold **INSERT (C)** on the remote control, then press **PAUSE (II)**. "IIC" and the Time Code (min.:sec.) appear and the camcorder enters Insert-Pause mode.

4 Press **START/STOP** to begin editing.

- Confirm the insert at the time code you checked in step 1.
- To pause editing, press **START/STOP**. Press it again to resume editing.

5 To end Insert Editing, press **START/STOP**, then **STOP (■)**.

NOTES:

- Programme AE with special effects (☞ pg. 24, 25) can be used to spice up the scenes being edited during Insert Editing.
- During Insert Editing, the date and time information changes.
- If you perform Insert Editing onto a blank space on the tape, the audio and video may be disrupted. Make sure you only edit recorded areas.
- During Insert Editing, when the tape moves to scenes recorded in the LP mode or a blank portion, Insert Editing stops (☞ pg. 66).

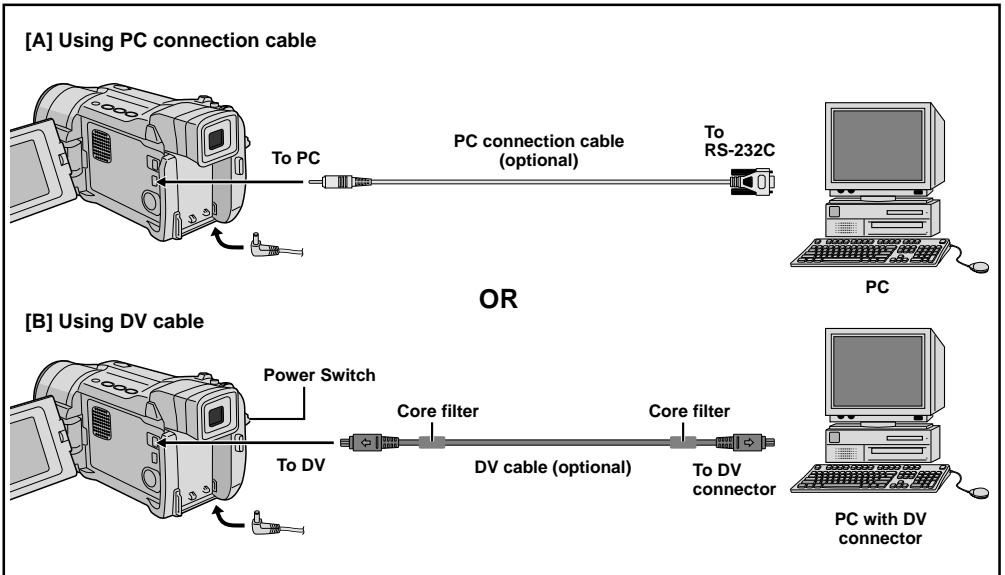

Connection To A Personal Computer

[A] Using PC connection cable

This camcorder can transfer still images to a PC by using the optional software HS-V16KITE.

[B] Using DV cable

It is also possible to transfer still images to a PC with a DV connector by using software equipped with the PC or commercially available software.

- 1** Make sure the camcorder and PC are turned off.
- 2** Connect the camcorder to your PC using the appropriate cable as shown in the illustration.
- 3** Turn the camcorder's Power Switch to "PLAY" while pressing down the Lock Button located on the switch and turn on the PC.
 - Refer to the instruction manual of the software on how to transfer a still image to the PC.
- 4** When finished, turn off the PC first, then the camcorder.

NOTES:

- It is recommended to use the AC Adapter as the power supply instead of the battery pack (☞ pg. 9).
- **Never connect the PC connection cable and the DV cable simultaneously to the camcorder. Connect only the cable you wish to use to the camcorder.**
- The date/time information cannot be captured into the PC.
- Refer to the instruction manuals of the PC and Software.
- The still images can also be transferred to a PC with a DV connector-equipped capture board.
- **When using a DV cable, be sure to use the optional JVC VC-VDV206U or VC-VDV204U DV cable depending on the type of DV connector (4 or 6 pins) on the PC, or use the DV cable provided with the capture board.**
- The system may not work properly depending on the PC or capture board you are using.

REFERENCES**CONTENTS**

| | |
|--|------------------------|
| DETAILS | 52 |
| TROUBLESHOOTING | 53 – 56 |
| USER MAINTENANCE | 57 |
| CAUTIONS | 58 – 59 |
| SPECIFICATIONS | 60 – 61 |
| INDEX | 62 – 66 |
| Controls, Connectors And Indicators | 62 – 63 |
| Indications | 64 – 66 |
| TERMS | 67 – <i>Back Cover</i> |

| ITEMS | NOTES |
|--|--|
| <p>⇒ Power (☞ pg. 8)</p> | <ul style="list-style-type: none"> ○ Perform charging where the temperature is between 10°C and 35°C. 20°C to 25°C is the ideal temperature range for charging. If the environment is too cold, charging may be incomplete. ○ Charging times are for a fully discharged battery pack. ○ Charging time varies according to the ambient temperature and the status of the battery pack. ○ To avoid interference with reception, do not use the AC Adapter near a radio. ○ Since the AC Adapter processes electricity internally, it becomes warm during use. Be sure to use it only in well-ventilated areas. ○ The following operation stops charging: <ul style="list-style-type: none"> • Set the Power Switch to "PLAY", "AUTO" or "MANUAL". • Disconnect the AC adapter from the camcorder. • Unplug the AC adapter's power cord from the AC outlet. • Detach the battery from the camcorder. |
| <p>⇒ RECORDING (☞ pg. 15, 16)</p> | <ul style="list-style-type: none"> ○ When you use the LCD monitor outdoors in direct sunlight, the LCD monitor may be difficult to see. If this happens, use the viewfinder instead. ○ The cassette holder cannot be opened unless a power supply is attached. ○ There may be a delay after you open the cassette holder cover until the cassette holder opens. Do not use force. ○ Once the cassette holder is closed, it recedes automatically. Wait until it recedes completely before closing the cassette holder cover. ○ When the Recording Start/Stop button is pressed, it may take a few seconds before actual recording starts. "⏻" starts rotating when the camcorder actually starts recording. ○ The time required to calculate and display the remaining tape length, and the accuracy of the calculation, may vary according to the type of tape used. ○ "TAPE END" appears when the tape reaches its end, and the power goes off automatically if left in this condition for 5 minutes. "TAPE END" also appears when a cassette at its end is loaded. |

If, after following the steps in the chart below, the problem still exists, please consult your nearest JVC dealer.

The camcorder is a microcomputer-controlled device. External noise and interference (from a TV, a radio, etc.) might prevent it from functioning properly. In such cases, first disconnect its power supply unit (battery pack, AC Adapter, etc.) and wait a few minutes; and then re-connect it and proceed as usual from the beginning.

| SYMPTOM | POSSIBLE CAUSES | CORRECTIVE ACTION |
|---|---|---|
| 1 No power is supplied. | <ul style="list-style-type: none"> • The power is not connected properly. • The battery is dead. | <ul style="list-style-type: none"> • Connect the AC Adapter securely (☞ pg. 9). • Replace the dead battery with a fully charged one (☞ pg. 8, 9). |
| 2 "SET DATE/TIME!" appears. | <ul style="list-style-type: none"> • The date/time is not set. • The built-in clock battery has run out and the previously set date/time has been erased. | <ul style="list-style-type: none"> • Set the date/time (☞ pg. 11). • Consult your nearest JVC dealer for replacement. |
| 3 Recording cannot be performed. | <ul style="list-style-type: none"> • The tape's erase protection tab is set to "SAVE". • The Power Switch is set to "PLAY" or "OFF". • "TAPE END" appears. • The cassette holder cover is open. | <ul style="list-style-type: none"> • Set the tape's erase protection tab to "REC" (☞ pg. 12). • Set the Power Switch to "AUTO" or "MANUAL" (☞ pg. 16). • Replace with new cassette (☞ pg. 12). • Close the cassette holder cover. |
| 4 There is no picture. | <ul style="list-style-type: none"> • The camcorder is not getting power, or some other malfunction exists. | <ul style="list-style-type: none"> • Turn the camcorder's power off and on again (☞ pg. 16). |
| 5 The focus does not adjust automatically. | <ul style="list-style-type: none"> • Focus is set to the Manual mode. • The recording was done in a dark place, or the contrast was low. • The lens is dirty or covered with condensation. | <ul style="list-style-type: none"> • Set Focus to the Auto mode (☞ pg. 29). • Clean the lens and check the focus again (☞ pg. 57). |
| 6 The cassette will not load properly. | <ul style="list-style-type: none"> • The cassette is in the wrong position. • The battery's charge is low. | <ul style="list-style-type: none"> • Set it in the right position (☞ pg. 12). • Install a fully charged battery (☞ pg. 8, 9). |
| 7 Snapshot mode cannot be used. | <ul style="list-style-type: none"> • The Squeeze mode is selected. | <ul style="list-style-type: none"> • Disengage the Squeeze mode (☞ pg. 34). |
| 8 The colour of Snapshot looks strange. | <ul style="list-style-type: none"> • The light source or the subject does not include white. Or there are various different light sources behind the subject. • The Sepia or Monotone mode is activated. | <ul style="list-style-type: none"> • Find a white subject and compose your shot so that it also appears in the frame (☞ pg. 28). • Turn off Sepia and Monotone (☞ pg. 24, 25). |

CONTINUED ON NEXT PAGE

| SYMPTOM | POSSIBLE CAUSES | CORRECTIVE ACTION |
|---|--|---|
| 9 The image taken using Snapshot is too dark. | <ul style="list-style-type: none"> • Shooting was performed under backlit conditions. | <ul style="list-style-type: none"> • Press the BACKLIGHT Button (☞ pg. 30). |
| 10 The image taken using Snapshot is too bright. | <ul style="list-style-type: none"> • The subject is too bright. | <ul style="list-style-type: none"> • Set "PROGRAMME AE" to "SPOTLIGHT" in the Menu Screen (☞ pg. 24). |
| 11 Digital Zoom does not work. | <ul style="list-style-type: none"> • 10X optical zoom is selected. | <ul style="list-style-type: none"> • Set "ZOOM" to "40X" or "500X" in the Menu Screen (☞ pg. 33). |
| 12 The Black & White Fader does not work. | <ul style="list-style-type: none"> • The Sepia or Monotone mode is activated. | <ul style="list-style-type: none"> • Turn off Sepia and Monotone (☞ pg. 24, 26). |
| 13 Even when Slow Shutter is not selected, the image looks like it is activated. | <ul style="list-style-type: none"> • When shooting in the dark, the unit becomes highly sensitive to light and the image takes on an effect similar to Slow Shutter. | <ul style="list-style-type: none"> • If you want the lighting to look more natural, set GAIN UP to "AGC" or "OFF" in the Menu Screen (☞ pg. 33). |
| 14 White Balance cannot be activated. | <ul style="list-style-type: none"> • The Sepia or Monotone mode is activated. | <ul style="list-style-type: none"> • Turn off Sepia or Monotone before setting White Balance (☞ pg. 25, 31). |
| 15 When shooting a subject illuminated by bright light, vertical lines appear. | <ul style="list-style-type: none"> • This is a result of exceedingly high contrast, and is not a malfunction. | <p style="text-align: center;">————</p> |
| 16 When the screen is under direct sunlight during shooting, the screen becomes red or black for an instant. | <ul style="list-style-type: none"> • This is not a malfunction. | <p style="text-align: center;">————</p> |
| 17 During recording, the date/time does not appear. | <ul style="list-style-type: none"> • "DATE/TIME" is set to "OFF" in the Menu Screen. | <ul style="list-style-type: none"> • Set "DATE/TIME" to "ON" in the Menu Screen (☞ pg. 35). |
| 18 Time code does not appear. | <ul style="list-style-type: none"> • "TIME CODE" is set to "OFF" in the Menu Screen. | <ul style="list-style-type: none"> • Set "TIME CODE" to "ON" in the Menu Screen (☞ pg. 35, 36). |
| 19 Images on the LCD monitor appear dark or whitish. | <ul style="list-style-type: none"> • In places subject to low temperature, images become dark due to the characteristics of the LCD monitor. When this happens, the displayed colours differ from those that are actually recorded. This is not a defect of the camcorder. • When the LCD monitor's fluorescent light reaches the end of its service life, images on the LCD monitor become dark. Consult your nearest JVC dealer. | <ul style="list-style-type: none"> • Adjust the brightness and angle of the LCD monitor (☞ pg. 15, 16). |

| SYMPTOM | POSSIBLE CAUSES | CORRECTIVE ACTION |
|---|---|---|
| 20 The rear of the LCD monitor is hot. | <ul style="list-style-type: none"> The light used to illuminate the LCD monitor causes it to become hot. | <ul style="list-style-type: none"> Close the LCD monitor to turn it off or set the Power Switch to "OFF", and let the unit cool down. |
| 21 The indicators and the image colour on the LCD monitor are not clear. | <ul style="list-style-type: none"> This may occur when the surface or the edge of the LCD monitor is pressed. | <p style="text-align: center;">_____</p> |
| 22 The LCD monitor or viewfinder indications blink. | <ul style="list-style-type: none"> Certain Fade/Wipe effects, certain modes of Programme AE with special effects, "DIS" and other functions that cannot be used together are selected at the same time. | <ul style="list-style-type: none"> Re-read the sections covering Fade/Wipe effects, Programme AE with special effects and "DIS" (☞ pg. 24 – 27, 33). |
| 23 Coloured bright spots appear all over the LCD monitor or the viewfinder. | <ul style="list-style-type: none"> The LCD monitor and the viewfinder are made with high-precision technology. However, black spots or bright spots of light (red, green or blue) may appear constantly on the LCD monitor or the viewfinder. These spots are not recorded on the tape. This is not due to any defect of the unit. (Effective dots: more than 99.99 %) | <p style="text-align: center;">_____</p> |
| 24 During recording, sound cannot be heard. | <ul style="list-style-type: none"> This is normal. | <p style="text-align: center;">_____</p> |
| 25 Play, Rewind and Fast-Forward functions do not work. | <ul style="list-style-type: none"> The Power Switch is set to "AUTO" or "MANUAL". | <ul style="list-style-type: none"> Set the Power Switch to "PLAY" (☞ pg. 19). |
| 26 The LCD monitor image is distorted. | <ul style="list-style-type: none"> During playback of the unrecorded portion, High-speed Search and still playback, LCD monitor indications appear distorted. This is not a defect. | <p style="text-align: center;">_____</p> |
| 27 Images on the LCD monitor are jittery. | <ul style="list-style-type: none"> The speaker volume is too great. | <ul style="list-style-type: none"> Turn the speaker volume down (☞ pg. 19). |
| 28 Blocks of noise appear during playback, or there is no playback picture and the screen becomes blue. | <p style="text-align: center;">_____</p> | <ul style="list-style-type: none"> Clean the video heads with an optional cleaning cassette (☞ pg. 59). |

CONTINUED ON NEXT PAGE

| SYMPTOM | POSSIBLE CAUSES | CORRECTIVE ACTION |
|--|--|--|
| 29 The LCD monitor, the viewfinder and the lens have become dirty (ex. fingerprints). | <hr/> | <ul style="list-style-type: none"> Wipe them gently with soft cloth. Wiping strongly can cause damage (☞ pg. 57). |
| 30 An unusual mark appears. | <hr/> | <ul style="list-style-type: none"> Check the section of the manual that explains LCD monitor/viewfinder indications (☞ pg. 64 – 66). |
| 31 An error indication (E01, E02 or E06) appears. | <ul style="list-style-type: none"> A malfunction of some kind has occurred. In this case the camcorder's functions become unusable. | <ul style="list-style-type: none"> Remove the power supply (battery pack, etc.) and wait a few minutes for the indication to clear. When it does, you can resume using the camcorder. If the indication remains even though you repeat the above two or three times, please consult your nearest JVC dealer. Do not eject the cassette. This will cause damage to the tape. |
| 32 An error indication (E03 or E04) appears. | <ul style="list-style-type: none"> A malfunction of some kind has occurred. In this case the camcorder's functions become unusable. | <ul style="list-style-type: none"> Eject the cassette once and re-insert it, then check if the indication clears. When it does, you can resume using the camcorder. If the indication remains even though you repeat the above two or three times, please consult your nearest JVC dealer. |
| 33 The charger indicator on the camcorder does not light. | <ul style="list-style-type: none"> The temperature of the battery is extremely high/low. Charging is difficult in places subject to extremely high/low temperatures. | <ul style="list-style-type: none"> To protect the battery, it is recommended to charge it in places with a temperature of 10°C to 35°C (☞ pg. 58). |
| 34 When the image is printed from the printer, a black bar appears at the bottom of the screen. | <ul style="list-style-type: none"> This is not a malfunction. | <ul style="list-style-type: none"> By recording with "DIS" activated (☞ pg. 33) this can be avoided. |
| 35 When the camcorder is connected via the DV connector, the camcorder does not operate. | <ul style="list-style-type: none"> The DV cable was plugged/unplugged with power turned on. | <ul style="list-style-type: none"> Turn the camcorder's power off and on again, then operate it. |

After Use

- 1** Turn off the camcorder.
- 2** Slide and hold **OPEN/EJECT** in the direction of the arrow, then pull the cassette holder cover open until it locks. The cassette holder opens automatically. Remove the cassette.
- 3** Press "PUSH HERE" to close the cassette holder.
 - Once the cassette holder is closed, it recedes automatically. Wait until it recedes completely before closing the cassette holder cover.
- 4** Tilt the viewfinder upward ①. Press **BATT. RELEASE** ② and remove the battery pack ③.

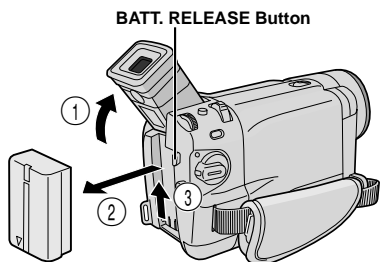
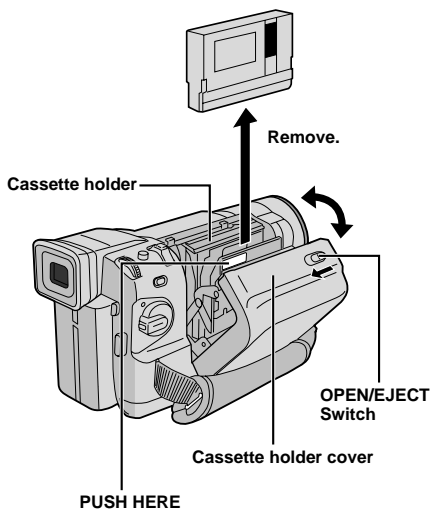

Cleaning The Camcorder

- 1** To clean the exterior, wipe gently with a soft cloth. Put the cloth in diluted mild soap and wring it well to wipe off heavy dirt. Then wipe again with a dry cloth.
- 2** Press **PUSH OPEN** and open the LCD monitor. Wipe gently with a soft cloth. Be careful not to damage the monitor. Close the LCD monitor.
- 3** To clean the lens, blow it with a blower brush, then wipe gently with lens cleaning paper.
- 4** To clean the viewfinder, raise it to the vertical position. Open the viewfinder cleaning hatch in the direction of the arrow ①.
- 5** Insert a lens blower or soft cloth into the gap at the bottom of the viewfinder and clean the interior of the viewfinder with it ②.
- 6** Close the hatch. Tilt the viewfinder back to the horizontal position.

NOTES:

- Avoid using strong cleaning agents such as benzine or alcohol.
- Cleaning should be done only after the battery pack has been removed or other power units have been disconnected.
- Mould may form if the lens is left dirty.
- When using a cleaner or chemically treated cloth refer to the cautions of each product.

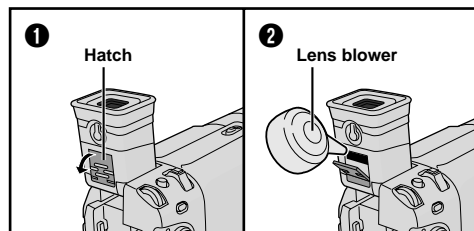
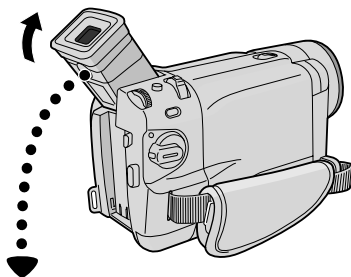

Battery Packs

The supplied battery pack is a lithium-ion battery. Before using the supplied battery pack or an optional battery pack, be sure to read the following cautions:

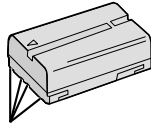

Terminals

1. **To avoid hazards . . .**
 - ... **do not** burn.
 - ... **do not** short-circuit the terminals. When transporting, make sure the provided battery cap is attached to the battery. If the battery cap is misplaced, carry the battery in a plastic bag.
 - ... **do not** modify or disassemble.
 - ... **do not** expose the battery to temperatures exceeding 60°C, as this may cause the battery to overheat, explode or catch fire.
 - ... use only specified chargers.
2. **To prevent damage and prolong service life . . .**
 - ... **do not** subject to unnecessary shock.
 - ... charge in an environment where temperatures are within the tolerances shown in the chart below. This is a chemical reaction type battery—cooler temperatures impede chemical reaction, while warmer temperatures can prevent complete charging.
 - ... store in a cool, dry place. Extended exposure to high temperatures will increase natural discharge and shorten service life.
 - ... fully charge and then fully discharge the battery every 6 months when storing the battery pack over a long period time.
 - ... remove from charger or powered unit when not in use, as some machines use current even when switched off.

NOTES:

- It is normal for the battery pack to be warm after charging, or after use.
- Temperature Range Specifications**
- | | |
|-----------------|---------------|
| Charging | 10°C to 35°C |
| Operation | 0°C to 40°C |
| Storage | -10°C to 30°C |
- Recharging time is based on room temperature of 20°C.
 - The lower the temperature, the longer recharging takes.

Cassettes

To properly use and store your cassettes, be sure to read the following cautions:

1. **During use . . .**
 - ... make sure the cassette bears the Mini DV mark.
 - ... be aware that recording onto prerecorded tapes automatically erases the previously recorded video and audio signals.
 - ... make sure the cassette is positioned properly when inserting.
 - ... do not load and unload the cassette repeatedly without allowing the tape to run at all. This slackens the tape and can result in damage.
 - ... do not open the front tape cover. This exposes the tape to fingerprints and dust.
2. **Store cassettes . . .**
 - ... away from heaters or other heat sources.
 - ... out of direct sunlight.
 - ... where they won't be subject to unnecessary shock or vibration.
 - ... where they won't be exposed to strong magnetic fields (such as those generated by motors, transformers or magnets).
 - ... vertically, in their original cases.

LCD Monitor

1. **To prevent damage to the LCD monitor, DO NOT . . .**
 - ... push it strongly or apply any shocks.
 - ... place the camcorder with the LCD monitor on the bottom.
2. **To prolong service life . . .**
 - ... avoid rubbing it with coarse cloth.
3. **Be aware of the following phenomena for LCD monitor use.**

These are not malfunctions:

 - While using the camcorder, the surface around the LCD monitor and/or the back of the LCD monitor may heat up.
 - If you leave power on for a long time, the surface around the LCD monitor becomes hot.

Main Unit

1. For safety, DO NOT . . .

- ... open the camcorder's chassis.
- ... disassemble or modify the unit.
- ... short-circuit the terminals of the battery pack. Keep it away from metallic objects when not in use.
- ... allow inflammables, water or metallic objects to enter the unit.
- ... remove the battery pack or disconnect the power supply while the power is on.
- ... leave the battery pack attached when the camcorder is not in use.

2. Avoid using the unit . . .

- ... in places subject to excessive humidity or dust.
- ... in places subject to soot or steam such as near a cooking stove.
- ... in places subject to excessive shock or vibration.
- ... near a television set.
- ... near appliances generating strong magnetic or electric fields (speakers, broadcasting antennas, etc.).
- ... in places subject to extremely high (over 40°C) extremely low (under 0°C) temperatures.

3. DO NOT leave the unit . . .

- ... in places of over 50°C.
- ... in places where humidity is extremely low (below 35%) or extremely high (above 80%).
- ... in direct sunlight.
- ... in a closed car in summer.
- ... near a heater.

4. To protect the unit, DO NOT . . .

- ... allow it to become wet.
- ... drop the unit or strike it against hard objects.
- ... subject it to shock or excessive vibration during transportation.
- ... keep the lens directed at extremely bright objects for long periods.
- ... expose the lens to direct sunlight.
- ... carry it by holding the LCD monitor or the viewfinder.
- ... swing it excessively when using the shoulder strap or the grip.

5. Dirty heads can cause the following problems:

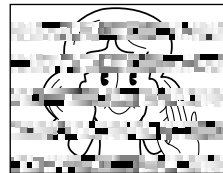

- No picture during playback.
- Blocks of noise appear during playback.
- During recording or playback, the Head Clog Warning indicator "⊗" appears.
- Recording cannot be performed properly.

In such cases, use an optional cleaning cassette. Insert it and play back. If the cassette is used more than once consecutively, damage to the video heads may result. After the camcorder plays back for about 20 seconds, it stops automatically. Also refer to the cleaning cassette's instructions. If, after using the cleaning cassette, the problems still exist, consult your nearest JVC dealer. Mechanical moving parts used to move the video heads and video tape tend to become dirty and worn out over time. In order to maintain a clear picture at all times, periodic check-ups are recommended after using the unit for about 1,000 hours. For periodic check-ups please consult your nearest JVC dealer.

About moisture condensation . . .

- You have observed that pouring a cold liquid into a glass will cause drops of water to form on the glass outer surface. This same phenomenon occurs on the head drum of a camcorder when it is moved from a cool place to a warm place, after heating a cold room, under extremely humid conditions or in a place directly subjected to the cool air from an air conditioner.
- Moisture on the head drum can cause severe damage to the video tape, and can lead to internal damage to the camcorder itself.

Serious malfunctioning

If malfunctioning occurs, stop using the unit immediately and consult your local JVC dealer.

The camcorder is a microcomputer-controlled device. External noise and interference (from a TV, a radio, etc.) might prevent it from functioning properly. In such cases, first disconnect its power supply unit (battery pack, AC Adapter, etc.) and wait a few minutes and then re-connect it and proceed as usual from the beginning.

Camcorder**General**

| | |
|---------------------------------------|---|
| Power supply | : DC 11.0 V $\overline{\text{---}}$ (Using AC Adapter) DC 7.2 V $\overline{\text{---}}$ (Using battery pack) |
| Power consumption | |
| LCD monitor off, viewfinder on | : Approx. 4.3 W |
| LCD monitor on, viewfinder off | : Approx. 5.3 W |
| Dimensions (W x H x D) | : 79 mm x 89 mm x 167 mm (with the LCD monitor closed and the viewfinder pushed down) |
| Weight | : Approx. 550 g |
| Operating temperature | : 0°C to 40°C |
| Operating humidity | : 35% to 80% |
| Storage temperature | : -20°C to 50°C |
| Pickup | : 1/4" CCD |
| Lens | : F 1.8, f = 3.6 mm to 36 mm, 10:1 power zoom lens |
| Filter diameter | : \varnothing 37 mm |
| LCD monitor | : 2.5" diagonally measured, LCD panel/TFT active matrix system |
| Viewfinder | : Electronic viewfinder with 0.24" black/white LCD |
| Speaker | : Monaural |

Digital Video Camera

| | |
|--|---|
| Format | : DV format (SD mode) |
| Signal format | : PAL standard |
| Recording/Playback format | : Video: Digital component recording Audio: PCM digital recording, 32 kHz 4-channel (12-bit), 48 kHz 2-channel (16-bit) |
| Cassette | : Mini DV cassette |
| Tape speed | : SP: 18.8 mm/s LP: 12.5 mm/s |
| Maximum recording time (using 80 min. cassette) | : SP: 80 min. LP: 120 min. |

Connectors

S-Video

Output : Y:1 V (p-p), 75 Ω , analogue
C:0.29 V (p-p), 75 Ω , analogue

AV

Video output : 1 V (p-p), 75 Ω , analogue
Audio output : 300 mV (rms), 1 k Ω , analogue, stereo

DV

Output : 4-pin, IEEE 1394 compliant

PC : \varnothing 2.5 mm, 3-pole

JLIP : \varnothing 3.5 mm, 4-pole

AC Adapter







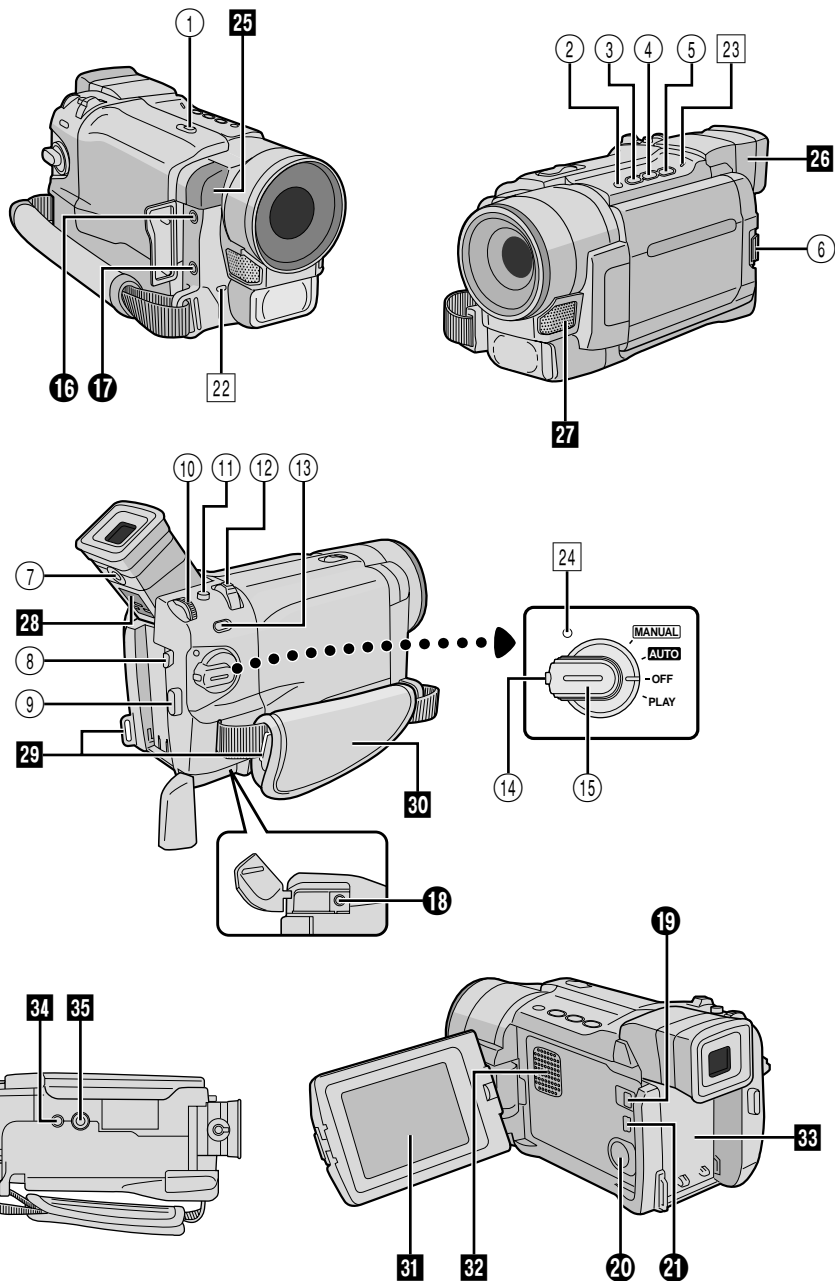













Power requirement : AC 110 V to 240 V \sim , 50 Hz/60 Hz

Output : DC 11 V $\overline{\text{---}}$, 1 A

Specifications shown are for SP mode unless otherwise indicated. E & O.E. Design and specifications subject to change without notice.









Controls



- ① OPEN/EJECT Switch  pg. 12
- ② • Stop Button [■]  pg. 19
- BACKLIGHT Button  pg. 30
- ③ • Rewind Button [◀◀]  pg. 19
- NIGHT Button  pg. 24
- ④ Play/Pause Button [▶/⏸]  pg. 19
- ⑤ Fast-Forward Button [▶▶]  pg. 19
- ⑥ Monitor Open Button [PUSH OPEN]  pg. 15
- ⑦ Dioptre Adjustment Control  pg. 10
- ⑧ Battery Release Button
[BATT. RELEASE]  pg. 8
- ⑨ Recording Start/Stop Button  pg. 15
- ⑩ • MENU Wheel [+ , - , PUSH]  pg. 32
- LCD Monitor BRIGHT (Brightness)
Control [+ , -]  pg. 15
- ⑪ Snapshot Button
[SNAPSHOT]  pg. 28
- ⑫ • Power Zoom Lever [T/W]  pg. 17
- Speaker Volume Control [VOL.]  pg. 19
- ⑬ • FOCUS Button  pg. 29
- BLANK Button  pg. 22
- ⑭ Lock Button  pg. 16
- ⑮ Power Switch
[**AUTO** , **MANUAL** , PLAY , OFF]  pg. 16

Connectors











The connectors 16 to 18 are located beneath a cover.

- 16 Audio/Video Output Connector
[AV]  pg. 20, 38, 44
- 17 J Terminal [JLIP (Joint Level Interface
Protocol)]  pg. 44
- You can also connect to a JLIP-compatible
camcorder or VCR to control it from the computer
using the optional Software HS-V16KITE.
- 18 DC Input Connector  pg. 8, 9
- 19 Digital Video Connector [DV OUT]
(i.Link*)  pg. 39, 50
- * i.Link refers to the IEEE1394-1995 industry
specification and extensions thereof. The  logo
is used for products compliant with the i.Link
standard.
- 20 S-Video Output Connector
[S-VIDEO]  pg. 20, 38, 44
- 21 PC Connector  pg. 50

Indicators

- 22 Tally Lamp  pg. 15, 34
- 23 CHARGE Lamp  pg. 8
- 24 Power Lamp  pg. 15, 16

Other Parts

- 25 • Remote Sensor  pg. 40
- Camera Sensor
Be careful not to cover this area, a sensor
necessary for shooting is built-in here.
- 26 Viewfinder  pg. 10
- 27 Stereo Microphone  pg. 48
- 28 Viewfinder Cleaning Hatch  pg. 57
- 29 Shoulder Strap Eyelets  pg. 10
- 30 Grip Strap  pg. 10
- 31 LCD Monitor  pg. 15, 16
- 32 Speaker  pg. 19
- 33 Battery Pack Mount  pg. 8
- 34 Stud Hole  pg. 10
- 35 Tripod Mounting Socket  pg. 10

LCD Monitor/Viewfinder Indications During Recording

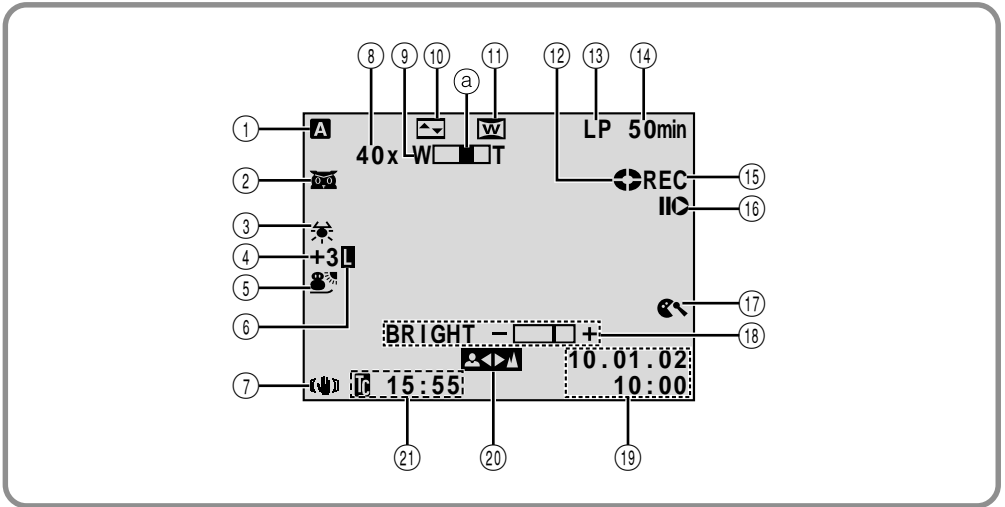





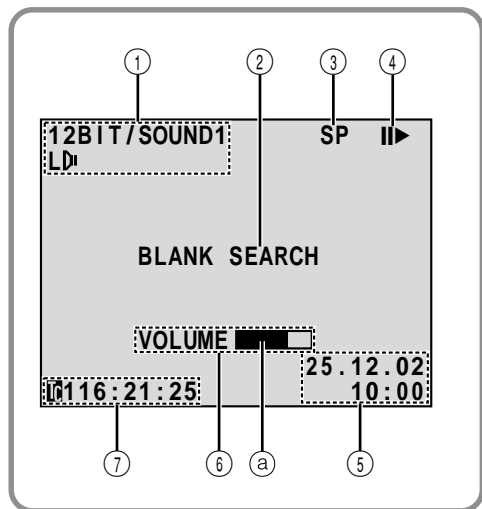



- ① Appears when the Power Switch is set to "AUTO". (☞ pg. 16)
- ② • : Appears when Night-Scope is engaged. (☞ pg. 24)
 - : Appears when "GAIN UP" is set to "AUTO" and the shutter speed is being automatically adjusted. (☞ pg. 33)
- ③ Appears when the white balance is adjusted. (☞ pg. 31)
- ④ • "±": Appears when the exposure is adjusted. (☞ pg. 30)
 - : Appears when backlight compensation is used. (☞ pg. 30)
- ⑤ Displays the selected Program AE with special effects. (☞ pg. 24)
- ⑥ Appears when the iris is locked. (☞ pg. 30)
- ⑦ Appears when Digital Image Stabilizer ("DIS") is engaged. (☞ pg. 33)
- ⑧ Approximate zoom ratio: Appears during zooming. (☞ pg. 17)
- ⑨ Appears during zooming.
 - ⓐ Zoom level indicator (☞ pg. 17)
- ⑩ Displays the selected Fade/Wipe effect. (☞ pg. 26, 27)
- ⑪ Appears when in the Squeeze or Cinema mode. (☞ pg. 34)
- ⑫ Rotates while the tape is running. (☞ pg. 15)
- ⑬ Displays the recording mode (SP or LP). (☞ pg. 13)
- ⑭ Displays the tape remaining time. (☞ pg. 15)
- ⑮ • "REC" appears during recording.
 - "PAUSE" appears during Record-Standby mode. (☞ pg. 15)
 - "PHOTO" appears when taking a Snapshot. (☞ pg. 28)
- ⑯ Appears when the Insert Editing () or Insert Editing Pause () mode is engaged. (☞ pg. 49)
- ⑰ Appears when the wind cut mode is engaged to cut down on noise created by wind. (☞ pg. 34)
- ⑱ • BRIGHT : Displays the brightness of the LCD monitor. (☞ pg. 15)
 - SOUND : Displays the sound mode for approx. 5 seconds after turning on the camcorder. (☞ pg. 33)
- ⑲ Displays the date/time. (☞ pg. 11)
- ⑳ Appears when the focus is adjusted manually. (☞ pg. 29)
- ㉑ Displays the Time Code. (☞ pg. 18, 35)

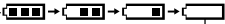



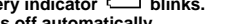





















































LCD Monitor/Viewfinder Indications During Playback



- ① Displays the sound mode. (☞ pg. 36, 37)
- ② Displays the Blank Search mode. (☞ pg. 22)
- ③ Displays the tape speed. (☞ pg. 13)
- ④ Appears while a tape is running.
 - ▶ : Playback
 - ▶▶ : Fast-Forward/Shuttle search
 - ◀◀ : Rewind/Shuttle search
 - || : Pause
 - ||▶ : Forward slow-motion
 - ◀|| : Reverse slow-motion
 - : Audio Dubbing
 - ||● : Audio Dubbing Pause
- ⑤ Displays the date/time. (☞ pg. 36, 37)
- ⑥ • BRIGHT : Displays the brightness of the LCD monitor. (☞ pg. 15)
 - VOLUME : Displays the speaker volume. (☞ pg. 19)
- a) The level indicator moves.
- ⑦ Displays the time code. (☞ pg. 36, 37)

Warning Indications

| Indications | Function |
|---|---|
|  | <p>Displays the battery remaining power.</p> <p>Remaining power level: high  →  →  → </p> <p>Remaining power level: exhausted </p> <p>As the battery power comes close to nil, the battery indicator  blinks. When the battery power is exhausted, power turns off automatically.</p> |
|  | <p>Appears when no tape is loaded. (☞ pg. 12)</p> |
| <p>CHECK TAPE'S ERASE PROTECTION TAB</p> | <p>Appears when the erase protection tab is set to "SAVE" while the Power Switch is set to "AUTO" or "MANUAL". (☞ pg. 12)</p> |
| <p> HEAD CLEANING REQUIRED USE CLEANING CASSETTE</p> | <p>Appears if dirt is detected on the heads during recording or playback. Use an optional cleaning cassette. (☞ pg. 59)</p> |
| <p> CONDENSATION OPERATION PAUSED PLEASE WAIT</p> | <p>Appears if condensation occurs. When this indication is displayed, wait more than 1 hour until condensation disappears.</p> |
| <p>TAPE!</p> | <p>Appears if a tape is not loaded when the Recording Start/Stop Button or SNAP-SHOT Button is pressed while the Power Switch is set to "AUTO" or "MANUAL".</p> |
| <p>TAPE END</p> | <p>Appears when the tape ends during recording or playback. (☞ pg. 52)</p> |
| <p>DIFFERENT FORMATTED TAPE</p> | <p>Appears if a tape in another format is loaded.</p> |
| <p>SET DATE/TIME!</p> | <ul style="list-style-type: none"> ● Appears when the date/time is not set. (☞ pg. 11) ● Appears when the built-in clock battery runs out and the previously set date/time is erased. Consult your nearest JVC dealer for replacement. |
| <p>LENS COVER</p> | <p>Appears for 5 seconds after power is turned on if the lens cap is attached.</p> |
| <p>A. DUB ERROR!</p> | <p>Appears if Audio Dubbing is attempted on a blank portion of a tape. (☞ pg. 48)</p> |
| <p>A. DUB ERROR! <CANNOT DUB ON A LP RECORDED TAPE> <CANNOT DUB ON A 16BIT RECORDING> <CHECK TAPE'S ERASE PROTECTION TAB></p> | <ul style="list-style-type: none"> ● Appears if Audio Dubbing is attempted on a tape recorded in the LP mode. (☞ pg. 48) ● Appears if Audio Dubbing is attempted on a tape recorded in 16-bit audio. (☞ pg. 48) ● Appears if A. DUB (⊕) on the remote control is pressed when the erase protection tab is set to "SAVE". (☞ pg. 48) |
| <p>INSERT ERROR!</p> | <p>Appears if Insert Editing is attempted on a blank portion of a tape. (☞ pg. 49)</p> |
| <p>INSERT ERROR! <CANNOT EDIT ON A LP RECORDED TAPE> <CHECK TAPE'S ERASE PROTECTION TAB></p> | <ul style="list-style-type: none"> ● Appears if Insert Editing is attempted on a tape recorded in the LP mode. (☞ pg. 49) ● Appears if INSERT (C) on the remote control is pressed when the erase protection tab is set to "SAVE". (☞ pg. 49) |
| <p>E01, E02 or E06 UNIT IN SAFEGUARD MODE REMOVE AND REATTACH BATTERY</p> | <p>The error indications (E01, E02 or E06) show what type of malfunction has occurred. When an error indication appears, the camcorder turns off automatically. Remove the power supply (battery, etc.) and wait a few minutes for the indication to clear. When it does, you can resume using the camcorder. If the indication remains, consult your nearest JVC dealer.</p> |
| <p>E03 or E04 UNIT IN SAFEGUARD MODE EJECT AND REINSERT TAPE</p> | <p>The error indications (E03 or E04) show what type of malfunction has occurred. When an error indication appears, the camcorder turns off automatically. Eject the cassette once and re-insert it, then check if the indication clears. When it does, you can resume using the camcorder. If the indication remains, consult your nearest JVC dealer.</p> |

- A**
- AC Adapter  pg. 8, 9
 - Audio Dubbing  pg. 48
 - Auto Date  pg. 35
 - Auto Focus  pg. 29
 - Auto Shut off  pg. 15, 19
- B**
- Backlight Compensation  pg. 30
 - Battery Low  pg. 66
 - Battery Pack  pg. 8, 9, 58
 - Beep  pg. 34
 - Blank Search  pg. 22
 - Brighten The LCD Monitor  pg. 15
- C**
- Channels (Left/Right)  pg. 37
 - Charge The Battery Pack  pg. 8
 - Cinema  pg. 34
 - Classic Film  pg. 25
 - Clean The Camcorder  pg. 57
 - Connections  pg. 8, 9, 20, 21, 38, 44, 50
- D**
- Darken The LCD Monitor  pg. 15
 - Date/Time Display  pg. 35 – 37
 - Date/Time Settings  pg. 11
 - Demonstration Mode  pg. 6, 35
 - Digital Zoom  pg. 17, 33
 - DIS (Digital Image Stabiliser)  pg. 33
 - Dioptré Adjustment  pg. 10
 - Dubbing  pg. 38, 39
- E**
- Erase Protection  pg. 12
 - Exposure Control  pg. 30
- F**
- Fade-In/Out  pg. 26, 27
 - Fast-Forward The Tape  pg. 19
 - Frame-By-Frame Playback  pg. 19
- G**
- Gain Up  pg. 33
 - Grip Adjustment  pg. 10
- I**
- Icons  pg. 33 – 35
 - Insert Editing  pg. 49
 - Iris  pg. 30
 - Iris Lock  pg. 30
- J**
- Journalistic Shooting  pg. 16
- L**
- LCD monitor/Viewfinder Indications  pg. 64 – 66
 - Load A Tape  pg. 12
- M**
- Manual Focus  pg. 29
 - Menu Screen, CAMERA  pg. 33
 - Menu Screen, DISPLAY  pg. 35, 36
 - Menu Screen, MANUAL  pg. 33, 34
 - Menu Screen, SYSTEM  pg. 34 – 36
 - Menu Screen, VIDEO  pg. 36
 - Monotone  pg. 25
 - Motor Drive Mode  pg. 28
- N**
- Night-Scope  pg. 24
- P**
- Playback Zoom  pg. 42
 - Power Switch Position  pg. 16
 - Programme AE With Special Effects  pg. 24, 25
 - Provided Accessories  pg. 5
- R**
- Random Assemble Editing  pg. 43 – 47
 - Record-Standby  pg. 15
 - Recording Mode  pg. 13
 - Remote Control  pg. 40
 - Reset  pg. 35
 - Rewind The Tape  pg. 19

CONTINUED ON NEXT PAGE

S

| | | |
|-----------------------------------|---|----------------|
| Self-Recording | ☞ | pg. 16 |
| Sepia | ☞ | pg. 25 |
| Set Remote Control/VCR Code | ☞ | pg. 43 |
| Shuttle Search | ☞ | pg. 19 |
| Shutter Speed | ☞ | pg. 25 |
| Slow Shutter | ☞ | pg. 25 |
| Snapshot | ☞ | pg. 28 |
| Snapshot Mode | ☞ | pg. 28 |
| Snow | ☞ | pg. 25 |
| Sound Mode | ☞ | pg. 33, 36, 37 |
| Speaker Volume | ☞ | pg. 19 |
| Specifications | ☞ | pg. 60, 61 |
| Sports | ☞ | pg. 25 |
| Spotlight | ☞ | pg. 25 |
| Squeeze | ☞ | pg. 34 |
| Still Playback | ☞ | pg. 19 |
| Strobe | ☞ | pg. 25 |

T

| | | |
|-----------------------|---|-----------------|
| Tally | ☞ | pg. 34 |
| Tele Macro | ☞ | pg. 34 |
| Time Code | ☞ | pg. 18, 35 – 37 |
| Tripod Mounting | ☞ | pg. 10 |
| Twilight | ☞ | pg. 25 |

U

| | | |
|---------------------|---|--------|
| Unload A Tape | ☞ | pg. 12 |
|---------------------|---|--------|

W

| | | |
|---------------------|---|------------|
| White Balance | ☞ | pg. 31 |
| Wide Mode | ☞ | pg. 34 |
| Wind Cut | ☞ | pg. 34 |
| Wipe In/Out | ☞ | pg. 26, 27 |

Z

| | | |
|---------------|---|--------|
| Zooming | ☞ | pg. 17 |
|---------------|---|--------|

See previous page as well.

JVC

VICTOR COMPANY OF JAPAN, LIMITED