

JVC®

ENGLISH

DIGITAL VIDEO CAMERA

GR-DV3000

Please visit our Homepage on the World Wide Web and answer our Consumer Survey (in English only):

<http://www.jvc-victor.co.jp/english/index-e.html>

For Accessories:

<http://www.jvc-victor.co.jp/english/accessory/>

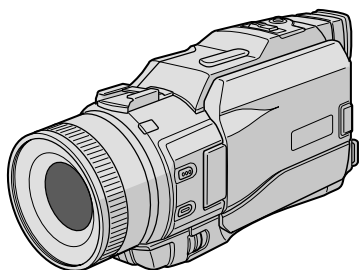

Mini DV PAL

DSC
DIGITAL
STILL CAMERA

INSTRUCTIONS

CONTENTS

AUTOMATIC DEMONSTRATION	7
GETTING STARTED	8 – 17
BASIC RECORDING	18 – 24
Recording On Tape	18
Recording On Memory Card	21
Recording On Tape And Memory Card	22
BASIC PLAYBACK	25 – 27
Playback From Tape	25
Playback From Memory Card	26
USING MENUS FOR DETAILED ADJUSTMENT	28 – 33
ADVANCED FEATURES	34 – 53
CONNECTIONS	54 – 57
Basic Connections	54
Advanced Connections	56
DUBBING	58 – 61
Dubbing To A VCR	58
Dubbing From A VCR	59
Dubbing To Or From A Video Unit Equipped With A DV Connector	60
Dubbing Still Images Recorded On A Tape To A Memory Card	61
USING THE REMOTE CONTROL UNIT	62 – 73
Slow-Motion Playback, Frame-By-Frame Playback and Playback Zoom	64
Playback Special Effects	65
Random Assemble Editing	66
For More Accurate Editing	70
Insert Editing	71
Audio Dubbing	72
TROUBLESHOOTING	74 – 79
USER MAINTENANCE	80
INDEX	81 – 88
Jack Box	81
Controls, Connectors And Indicators	82
Indications	84
CAUTIONS	89 – 91
TERMS	92 – 93
SPECIFICATIONS	94 – 95

LYT0972-001A

EN

Dear Customer,

Thank you for purchasing this digital video camera. Before use, please read the safety information and precautions contained in the following pages to ensure safe use of this product.

Using This Instruction Manual

- All major sections and subsections are listed in the Table Of Contents on the cover page.
- Notes appear after most subsections. Be sure to read these as well.
- Basic and advanced features/operation are separated for easier reference.

It is recommended that you . . .

- refer to the Index (☞ pgs. 81 – 88) and familiarize yourself with button locations, etc. before use.
- read thoroughly the Safety Precautions. They contain extremely important information regarding the safe use of this product.

You are recommended to carefully read the cautions on pages 89 through 91 before use.

SAFETY PRECAUTIONS

WARNING:

TO PREVENT FIRE OR SHOCK HAZARD, DO NOT EXPOSE THIS UNIT TO RAIN OR MOISTURE.

**Caution: (applies to Jack Box)**

To reduce the risk of fire, do not remove cover. No user-serviceable parts inside. Refer servicing to qualified service person.

CAUTIONS:

- If you notice smoke or a peculiar smell coming from the camcorder or AC adapter/charger, shut it down and unplug it immediately. Continue using the camcorder or AC adapter/charger under these conditions could lead to fire or electric shock. Contact your JVC dealer. Do not attempt to repair the malfunction yourself.
- To prevent shock, do not open the cabinet. No user serviceable parts inside. Refer servicing to qualified personnel.
- When you are not using the AC Power Adapter/Charger for a long period of time, it is recommended that you disconnect the power cord from AC outlet.

NOTES:

- The rating plate (serial number plate) and safety caution are on the bottom and/or the back of the main unit.
- The rating plate (serial number plate) of the AC Power Adapter/Charger is on its bottom.

This camcorder is designed to be used with PAL-type colour television signals. It cannot be used for playback with a television of a different standard. However, live recording and LCD monitor/ viewfinder playback are possible anywhere. Use the JVC BN-V408U/V416U/V428U battery packs and, to recharge them, the provided multi-voltage AC Power Adapter/Charger. (An appropriate conversion adapter may be necessary to accommodate different designs of AC outlets in different countries.)

When the equipment is installed in a cabinet or on a shelf, make sure that it has sufficient space on all sides to allow for ventilation (10 cm or more on both sides, on top and at the rear).

Do not block the ventilation holes.

(If the ventilation holes are blocked by a newspaper, or cloth etc. the heat may not be able to get out.)

No naked flame sources, such as lighted candles, should be placed on the apparatus.

When discarding batteries, environmental problems must be considered and the local rules or laws governing the disposal of these batteries must be followed strictly.

The apparatus shall not be exposed to dripping or splashing.

Do not use this equipment in a bathroom or places with water.

Also do not place any containers filled with water or liquids (such as cosmetics or medicines, flower vases, potted plants, cups etc.) on top of this unit.

(If water or liquid is allowed to enter this equipment, fire or electric shock may be caused.)

Do not point the lens or the viewfinder directly into the sun. This can cause eye injuries, as well as lead to the malfunctioning of internal circuitry. There is also a risk of fire or electric shock.

CAUTION!

The following notes concern possible physical damage to the camcorder and to the user.

When carrying, be sure to always securely attach and use the provided shoulder strap. Carrying or holding the camcorder by the viewfinder and/or the LCD monitor can result in dropping the unit, or in a malfunction.

Take care not to get your finger caught in the cassette holder cover. Do not let children operate the camcorder, as they are particularly susceptible to this type of injury.

Do not use a tripod on unsteady or unlevel surfaces. It could tip over, causing serious damage to the camcorder.

CAUTION!

Attaching the Jack Box to the camcorder with cables (S-Video, Editing, DC, etc.) connected, then leaving it on top of the TV is not recommended, as tripping on the cables will cause the camcorder to fall, resulting in damage.

Attach only the optional JVC VL-V3U Video Light, VL-F3U Video Flash or MZ-V3U Stereo Zoom Microphone to the camcorder's Info-Shoe.

Mini **DV** PAL  **MultiMediaCard**

- This camcorder is designed exclusively for the digital video cassette, SD Memory Card and MultiMediaCard. Only cassettes marked "Mini DV" and memory cards marked "SD" or "MultiMediaCard" can be used with this unit.

Before recording an important scene . . .

.... make sure you only use cassettes with the Mini DV mark ^{Mini}DV.

.... make sure you only use memory cards with the mark **SD** or *MultiMediaCard*.

.... remember that this camcorder is not compatible with other digital video formats.

.... remember that this camcorder is intended for private consumer use only. Any commercial use without proper permission is prohibited. (Even if you record an event such as a show, performance or exhibition for personal enjoyment, it is strongly recommended that you obtain permission beforehand.)

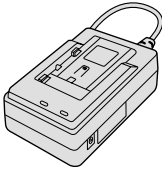

AC Power Adapter/Charger
AA-V40EA, AA-V40A,
AA-V40SH or AA-V40ED

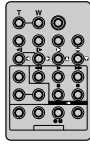

Remote Control Unit
RM-V717U

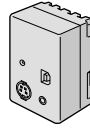

Jack Box
CU-V504U

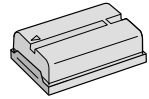

Battery Pack
BN-V408U

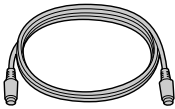

S-Video cable

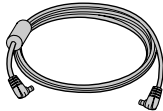

DC Cord

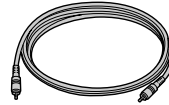

Editing Cable



Audio/Video Cable
(ø3.5 mini-plug to
RCA plug)



Audio Cable
(for connection
of optional
headphones)



Lens Hood
(Already attached
to the camcorder
☞ pg. 5)



Lens Cap
(☞ pg. 5 for
attachment)

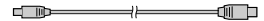

USB Cable

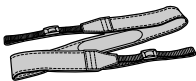

Shoulder Strap

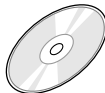

CD-ROM



AAA (R03) Battery x 2
(for remote control unit)

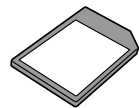

Memory Card (8 MB)
(Already inserted in
the camcorder)

NOTE:

In order to maintain optimum performance of the camcorder, provided cables may be equipped with one or more core filter. If a cable has only one core filter, the end that is closest to the filter should be connected to the camcorder.

How To Detach/Attach The Lens Hood

The provided lens hood helps block out glare when shooting under bright sunlight, the same way professional photographers do.

To detach:
Turn the lens hood counterclockwise.

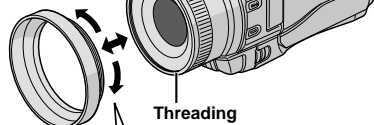

To attach:
Align the lens hood with the camcorder's lens and screw it in clockwise.

How To Attach The Lens Cap

To protect the lens, attach the provided lens cap to the camcorder as shown in the illustration.

NOTE:

To confirm the lens cap is on correctly make sure the cap is flush to the camera.

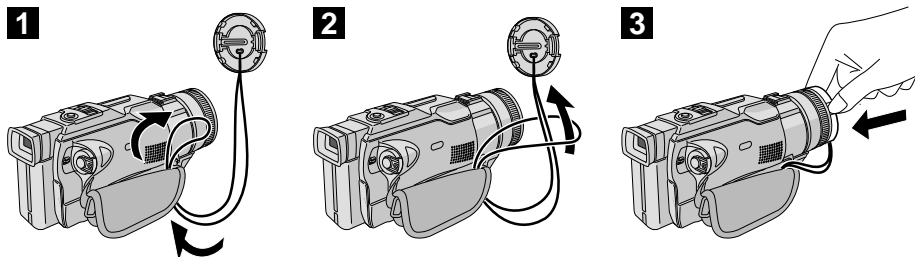

The lens cap can be attached/
removed even with the lens
hood attached to the camcorder.

How To Use Audio Cables

When using an optional headphones, connect to the provided Audio cable (with a core filter attached), then connect the Audio cable to the camcorder. The core filter reduces interference.

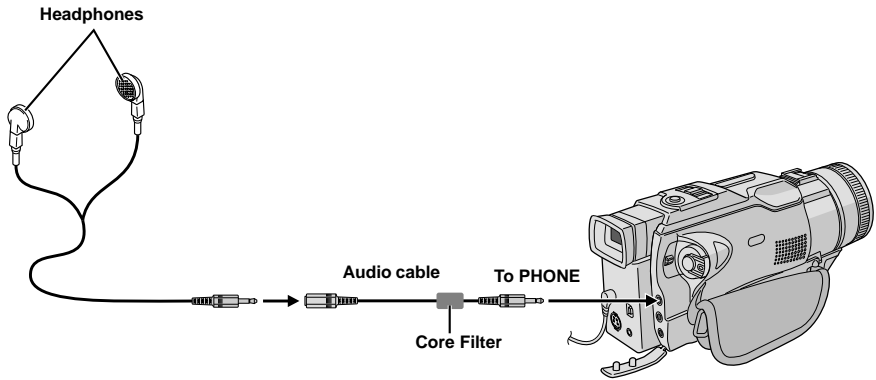

AUTOMATIC DEMONSTRATION

Automatic Demonstration takes place when “DEMO MODE” is set to “ON” (factory-preset).

- Automatic Demonstration starts when there is no operation for about 3 minutes after the Power Switch is set to “**A**” or “**M**” and no cassette is in the camcorder.
- Performing any operation during the demonstration stops the demonstration temporarily. If no operation is performed for more than 3 minutes after that, the demonstration will resume.
- “DEMO MODE” remains “ON” even if the camcorder power is turned off.
- To cancel Automatic Demonstration:
 1. Set the Power Switch to “**M**” while pressing down the Lock Button located on the switch and press the **MENU** wheel in. The Menu Screen appears.
 2. Rotate the **MENU** wheel to select “**SYSTEM**” and press it. The SYSTEM Menu appears.
 3. Rotate the **MENU** wheel to select “DEMO MODE” and press it. The Sub Menu appears.
 4. Rotate the **MENU** wheel to select “OFF” and press it.
 5. Rotate the **MENU** wheel to select “**RETURN**”, and press it twice. The normal screen appears.

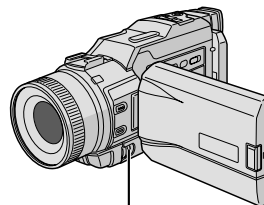

MENU Wheel

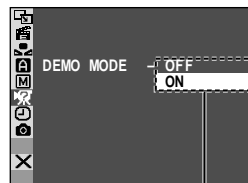

Sub Menu

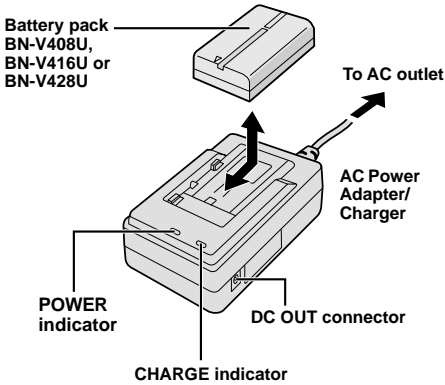

Battery pack	Fully charging time
BN-V408U	approx. 1 hr. 30 min.
BN-V416U (optional)	approx. 2 hrs.
BN-V428U (optional)	approx. 3 hrs. 20 min.

NOTES:

- If the protective cap is attached to the battery pack, remove it first.
- Perform charging where the temperature is between 10°C and 35°C. 20°C to 25°C is the ideal temperature range for charging. If the environment is too cold, charging may be incomplete.
- Charging times noted above are for a fully discharged battery pack.
- Charging time varies according to the ambient temperature and the status of the battery pack.
- To avoid interference with reception, do not use the AC Power Adapter/Charger near a radio.
- If you connect the camcorder's DC cord to the adapter during battery charging, power is supplied to the camcorder and charging stops.
- Since the AC Power Adapter/Charger processes electricity internally, it becomes warm during use. Be sure to use it only in well-ventilated areas.
- When charging the battery pack for the first time or after a long storage period, the CHARGE indicator may not light. In this case, remove the battery pack from the AC Power Adapter/Charger, then try charging again.
- If the battery operation time remains extremely short even after having been fully charged, the battery is worn out and needs to be replaced. Please purchase a new one.

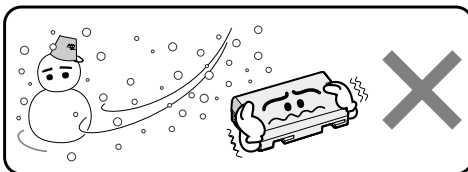

Lithium-ion is vulnerable in colder temperatures.

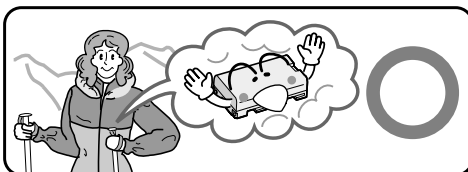

Power

This camcorder's 2-way power supply system lets you choose the most appropriate source of power. Do not use provided power supply units with other equipment.

CHARGING THE BATTERY PACK

- 1** Make sure you unplug the camcorder's DC cord from the AC Power Adapter/Charger. Plug the AC Adapter/Charger's power cord into an AC outlet. The POWER indicator lights.
- 2** Attach the battery pack with the $\oplus \ominus$ mark aligned with the corresponding marks on the AC Power Adapter/Charger. The CHARGE indicator begins blinking to indicate charging has started.
- 3** When the CHARGE indicator stops blinking but stays lit, charging is finished. Slide the battery and lift off. Remember to unplug the AC Adapter/Charger's power cord from the AC outlet.

About Batteries

DANGER! Do not attempt to take the batteries apart, or expose them to flame or excessive heat, as it may cause a fire or explosion.

WARNING! Do not allow the battery or its terminals to come in contact with metals, as this can result in a short circuit and possibly start a fire.

The Benefits Of Lithium-Ion Batteries

Lithium-ion battery packs are small but have a large power capacity. However, when one is exposed to cold temperatures (below 10°C), its usage time becomes shorter and it may cease to function. If this happens, place the battery pack in your pocket or other warm, protected place for a short time, then re-attach it to the camcorder. As long as the battery pack itself is not cold, it should not affect performance.

(If you're using a heating pad, make sure the battery pack does not come in direct contact with it.)

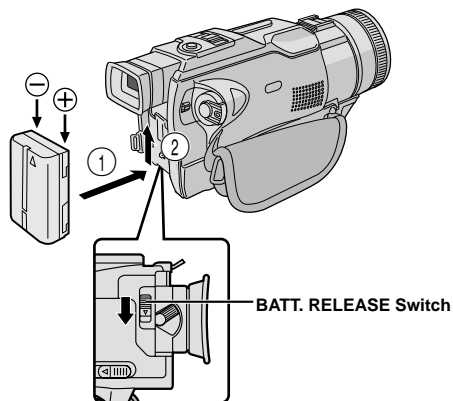

ATTENTION

Before detaching the power source, make sure that the camcorder's power is turned off. Failure to do so can result in a camcorder malfunction.

INFORMATION

The extended-use battery pack kit is a set composed of a battery pack and AC Power Adapter/Charger:

VU-V840 KIT: BN-V840U battery pack & AA-V15 AC Power Adapter/Charger

VU-V856 KIT: BN-V856U battery pack & AA-V80 AC Power Adapter/Charger

Read the kit's instruction manual before using.

Neither BN-V840U nor BN-V856U can be charged by using the AC Power Adapter/Charger provided with this camcorder. Use only the AA-V15 AC Power Adapter/Charger for BN-V840U battery pack and only AA-V80 AC Power Adapter/Charger for BN-V856U battery pack.

USING THE BATTERY PACK

- 1** With the arrow on the battery pack pointing upward, push the battery pack slightly against the battery pack mount ①.
 - 2** Slide up the battery pack until it locks in place ②.
- If the battery pack is attached with its ⊕ ⊖ mark set in the wrong direction, a malfunction may occur.

To Detach The Battery Pack . . .

..... slide the battery pack down slightly while sliding down **BATT. RELEASE** to detach it.

Approximate recording time

Battery pack	LCD monitor on/ Viewfinder off	LCD monitor off/ Viewfinder on
BN-V408U	1 hr. 5 min.	1 hr. 15 min.
BN-V416U (optional)	2 hrs. 10 min.	2 hrs. 30 min.
BN-V428U (optional)	3 hrs. 50 min.	4 hrs. 20 min.
BN-V840U (optional)	5 hrs. 20 min.	6 hrs. 10 min.
BN-V856U (optional)	7 hrs. 30 min.	8 hrs. 40 min.

NOTES:

- Recording time is reduced significantly under the following conditions:
 - Zoom or Record-Standby mode is engaged repeatedly.
 - The LCD monitor is used repeatedly.
 - The playback mode is engaged repeatedly.
- Before extended use, it is recommended that you prepare enough battery packs to cover 3 times the planned shooting time.

USING AC POWER

Use the AC Power Adapter/Charger (connect as shown in the illustration).

NOTES:

- The provided AC Power Adapter/Charger features automatic voltage selection in the AC range from 110 V to 240 V.
- For other notes, pg. 8.

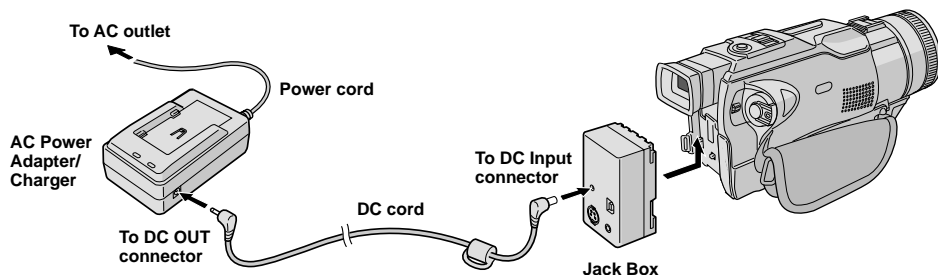

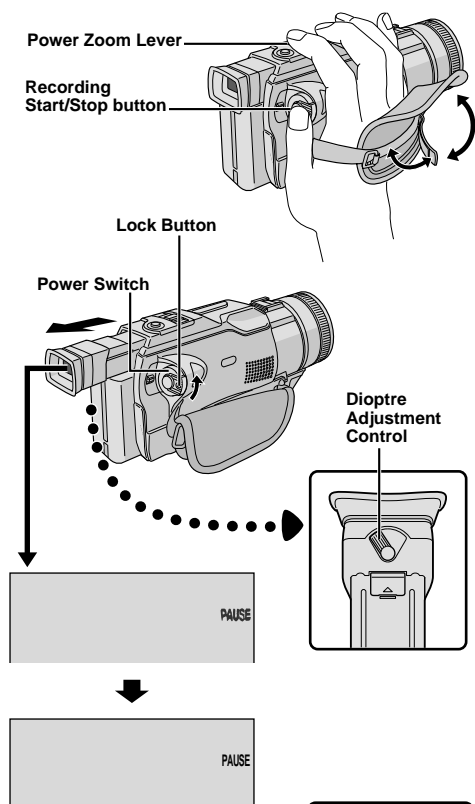

Grip Adjustment

- 1** Separate the Velcro strip.
- 2** Pass your right hand through the loop and grasp the grip.
- 3** Adjust your thumb and fingers through the grip, to easily operate the Recording Start/Stop button and Power Switch and Power Zoom Lever. Be sure to fasten the Velcro strip to your preference.

Viewfinder Adjustment

- 1** Set the Power Switch to "A" or "M" while pressing down the Lock Button located on the switch.
- 2** Pull out the viewfinder fully and adjust it manually for best viewability.
- 3** Turn the Dioptre Adjustment Control until the indications in the viewfinder are clearly focused.

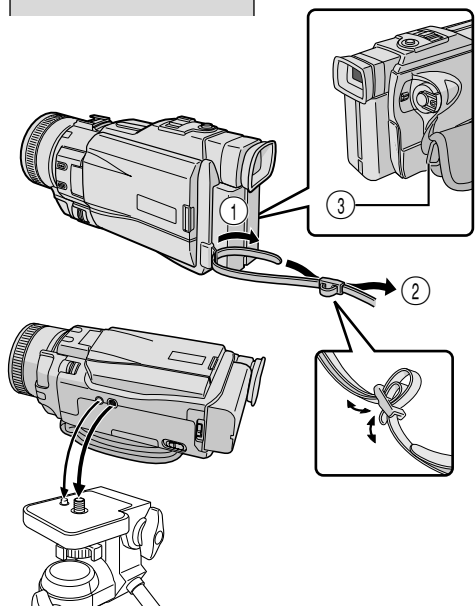

Shoulder Strap Attachment

- 1** Following the illustration, thread the strap through the eyelet ①, then fold it back and thread it through the buckle ②. Repeat the procedure to attach the other end of the strap to the other eyelet ③ located under the Grip Strap. Confirm the strap is not twisted.

Tripod Mounting

CAUTION

When attaching the camcorder to a tripod, extend its legs to stabilise the camcorder. It is not advised to use small sized tripods. This may cause damage to the unit by falling over.

- 1** To attach the camcorder to a tripod, align the direction stud and screw to the mounting socket and stud hole on the camcorder. Then tighten the screw clockwise. Some tripods are not equipped with studs.

Date/Time Settings

The date/time is recorded onto the tape at all times, but its display can be turned on or off during playback (▶ pg. 31, 32).

1 Set the Power Switch to “**M**” while pressing down the Lock Button located on the switch, and open the LCD monitor fully or pull out the viewfinder fully. The power lamp lights and the camcorder is turned on.

2 Press the **MENU** wheel in. The Menu Screen appears.

3 Rotate the **MENU** wheel to select “**DISPLAY**”. Press it and the DISPLAY Menu appears.

4 Rotate the **MENU** wheel to select “**CLOCK ADJ.**”. Press it and “day” is highlighted. Rotate the **MENU** wheel to input the day. Press it. Repeat to input the month, year, hour and minute. Rotate the **MENU** wheel to select “**RETURN**”, and press it twice. The Menu Screen closes.

NOTE:

Even if you select “**CLOCK ADJ.**”, if the parameter is not highlighted the camcorder’s internal clock continues to operate. Once you move the highlight bar to the first date/time parameter (day), the clock stops. When you finish setting the minute and press the **MENU** wheel, the date and time begin operation from the date and time you just set.

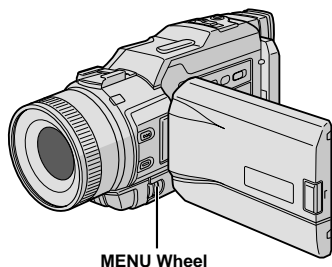
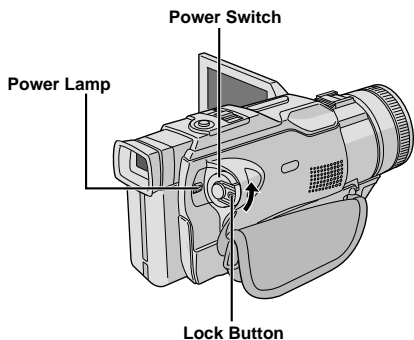

Display

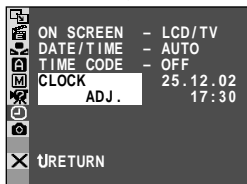
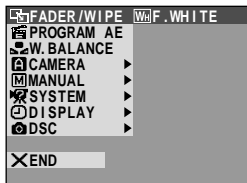

DISPLAY Menu

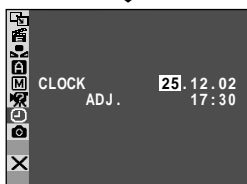

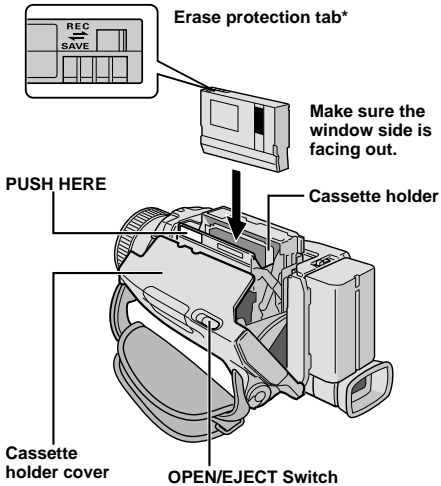

Loading/Unloading A Cassette

The camcorder needs to be powered up to load or eject a cassette.

1 Slide and hold **OPEN/EJECT** in the direction of the arrow then pull the cassette holder cover open until it locks. The cassette holder opens automatically.

- Do not touch internal components.

2 Insert or remove a tape and press "PUSH HERE" to close the cassette holder.

- Once the cassette holder is closed, it recedes automatically. Wait until it recedes completely before closing the cassette holder cover.
- When the battery's charge is low, you may not be able to close the cassette holder cover. Do not apply force. Replace the battery with a fully charged one before continuing.

3 Close the cassette holder cover firmly until it locks into place.

Approximate recording time

Tape	Recording mode	
	SP	LP
30 min.	30 min.	45 min.
60 min.	60 min.	90 min.
80 min.	80 min.	120 min.

* To Protect Valuable Recordings . . .

... slide the erase protection tab on the back of the tape in the direction of "SAVE". This prevents the tape from being recorded over. To record on this tape, slide the tab back to "REC" before loading it.

Be sure to press only the section labeled "PUSH HERE" to close the cassette holder; touching other parts may cause your finger to get caught in the cassette holder, resulting in injury or product damage.

NOTES:

- It takes a few seconds for the cassette holder to open. Do not apply force.
- If you wait a few seconds and the cassette holder does not open, close the cassette holder cover and try again. If the cassette holder still does not open, turn the camcorder off then on again.
- If the tape does not load properly, open the cassette holder cover fully and remove the cassette. A few minutes later, insert it again.
- When the camcorder is suddenly moved from a cold place to a warm environment, wait a short time before opening the cassette holder cover.
- Closing the cassette holder cover before the cassette holder comes out may cause damage to the camcorder.
- Even when the camcorder is switched off, a cassette can be loaded or unloaded. After the cassette holder is closed with the camcorder switched off, however, it may not recede. It is recommended to turn the power on before loading or unloading.
- When resuming recording, once you open the cassette holder cover a blank portion will be recorded on the tape or a previously recorded scene will be erased (recorded over) regardless of whether the cassette holder came out or not. See page 23 for information about recording from the middle of a tape.

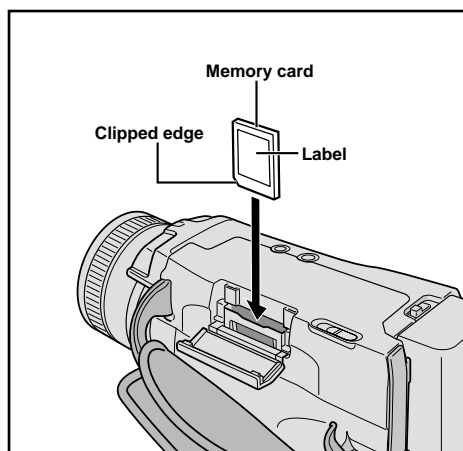
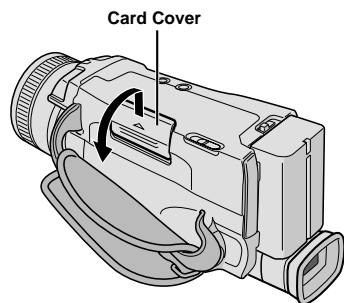

Loading A Memory Card

The provided memory card is already inserted in the camcorder when you receive the camcorder.

- 1** Make sure the camcorder's power is off.
- 2** Open the card cover (**MEMORY CARD**).
- 3** Insert the memory card clipped edge first.
 - Do not touch the terminal on the reverse side of the label.
- 4** To close the card cover, push it until you hear a click.

To Unload A Memory Card . . .

..... In step 3 push the memory card, which then comes out of the camcorder automatically. Pull it out and close the card cover.

NOTES:

- Be sure to use only SD Memory Cards marked "**SD**." or MultiMediaCards marked "*MultiMediaCard*".
- Some brands of memory cards are not compatible with this camcorder. Before purchasing a memory card, consult its manufacturer or dealer.
- Before using a new memory card, it is necessary to **FORMAT** the card. ☞ pg. 51.

ATTENTION

Do not insert/remove the memory card while the camcorder is turned on, as this may cause the memory card to be corrupted or cause the camcorder to become unable to recognize whether or not the card is installed.

To Protect Valuable Files (available only for SD Memory Card) . . .

Write/erase
protection tab

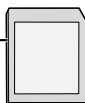

..... slide the write/erase protection tab on the side of the memory card in the direction of "LOCK". This prevents the memory card from being recorded over. To record on this memory card, slide the tab back to the position opposite to "LOCK" before loading it.

To turn on the camcorder, first set the Power Switch to any operation mode except "OFF" while pressing down the Lock Button located on the switch, then pull out the viewfinder fully or open the LCD monitor fully.

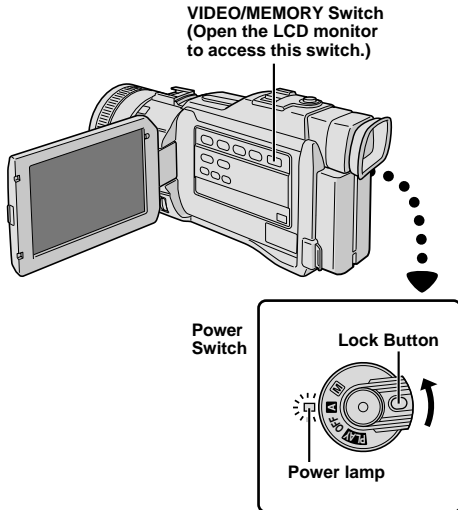

When the Power Switch is set to "A", "A" appears. When set to "M" or "PLAY", there is no indication.

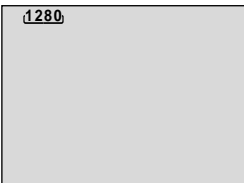

When the Power Switch is set to "A" or "M" and the VIDEO/MEMORY Switch is set to "MEMORY", the currently selected image size appears. When set to "VIDEO", there is no indication.

Operation Mode

Choose the appropriate operation mode according to your preference using the Power Switch and VIDEO/MEMORY Switch.

Power Switch Position	
M (Manual):	Allows you to set various recording functions using the Menus. If you want more creative capabilities than Full Auto recording, try this mode.
A (Full Auto):	Allows you to record using NO special effects or manual adjustments. Suitable for standard recording.
OFF:	Allows you to switch off the camcorder.
PLAY :	Allows you to play back a recording on the tape, to access data stored on the memory card or to transfer a still image recorded on the tape or memory card to a computer.

VIDEO/MEMORY Switch Position	
VIDEO:	<ul style="list-style-type: none"> Allows you to record on a tape or play back a tape. Approx. 6 seconds of a still image can also be recorded on a tape (pg. 20). If "REC SELECT" is set to "▶ [VIDEO] / ▶ [MEMORY]" in the DSC Menu Screen, still images are recorded on the memory card as well. Zoom magnification over 10X is available (pg. 22, 29).
MEMORY:	<p>Allows you to record on a memory card or access data stored on a memory card.</p> <p>File size (still image) : 640 x 480 pixels, 1024 x 768 pixels, 1280 x 960 pixels or 1600 x 1200 pixels.</p> <p>File size (moving image): 160 x 120 pixels or 240 x 176 pixels.</p>

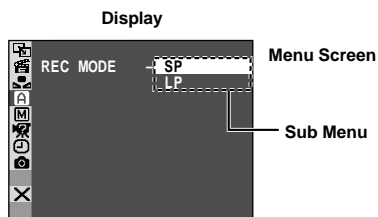
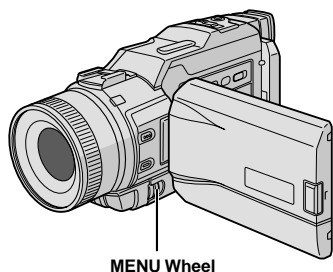
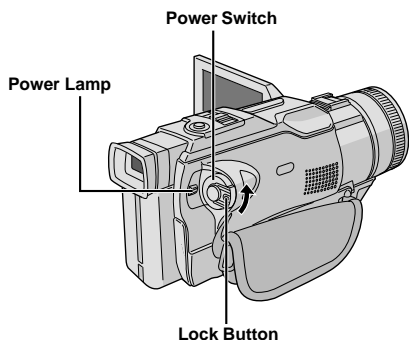

Recording Mode Setting

Set the tape recording mode depending on your preference.

1 Set the Power Switch to “**M**” while pressing down the Lock Button located on the switch, and open the LCD monitor fully or pull out the viewfinder fully. The power lamp lights and the camcorder is turned on.

2 Press the **MENU** wheel in. The Menu Screen appears.

3 Rotate the **MENU** wheel to select “**CAMERA**” and press it. The CAMERA Menu appears.

4 Rotate the **MENU** wheel to select “REC MODE” and press it. The Sub Menu appears. Select “SP” or “LP” by rotating the **MENU** wheel and press it. Rotate the **MENU** wheel to select “**RETURN**”, and press it twice. The Menu Screen closes.

- Audio Dubbing (pg. 72) and Insert Editing (pg. 71) are possible on tapes recorded in the SP mode.
- “LP” (Long Play) is more economical, providing 1.5 times the recording time.

NOTES:

- If the recording mode is switched during recording, the playback picture will be blurred at the switching point.
- It is recommended that tapes recorded in the LP mode on this camcorder be played back on this camcorder.
- During playback of a tape recorded on another camcorder, blocks of noise may appear or there may be momentary pauses in the sound.

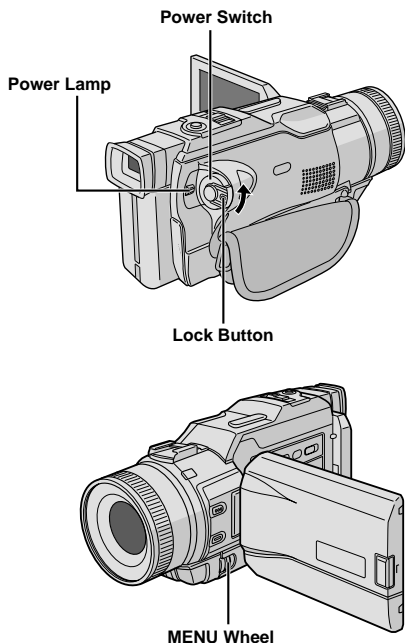

Display



Menu Screen

Picture Quality/Image Size Setting

The Picture Quality/Image Size can be selected to best match your needs. Refer to the chart on page 17 for your selection.

- 1** Set the Power Switch to "[M]" while pressing down the Lock Button located on the switch, and open the LCD monitor fully or pull out the viewfinder fully. The power lamp lights and the camcorder turns on.
- 2** Press the **MENU** wheel in. The Menu Screen appears.
- 3** Rotate the **MENU** wheel to select "[DSC]" and press it. The DSC Menu appears.
- 4** Rotate the **MENU** wheel to select "QUALITY" and press it. The Sub Menu appears. Rotate the **MENU** wheel to select the desired mode and press it.
- 5** Rotate the **MENU** wheel to select "IMAGE SIZE" and press it. The Sub Menu appears. Rotate the **MENU** wheel to select the desired mode and press it.
- 6** Rotate the **MENU** wheel to select "[RETURN]", and press it twice. The Menu Screen closes.

NOTES:

- With images shot in the 1600 X 1200 mode, the shutter speed is applicable only up to 1/500 in the "SPORTS" mode (pg. 39).
- Changing the Image Size can only be made if the **VIDEO/MEMORY** switch is in the **MEMORY** position.

STORAGE CAPACITY

The number of storable images depends on the selected picture quality and size as well as the composition of the subjects in the images.

Approximate number of storable images

IMAGE SIZE	QUALITY	SD Memory Card (optional)			
		8 MB*	16 MB	32 MB	64 MB
640 x 480	FINE	32	98	205	405
	STANDARD	110	295	625	1215
1024 x 768	FINE	14	46	98	190
	STANDARD	46	145	310	605
1280 x 960	FINE	9	28	62	120
	STANDARD	30	98	205	405
1600 x 1200	FINE	6	18	40	78
	STANDARD	20	62	130	260

* Since sound effects (🔊 pg. 45) and titles (📄 pg. 48) are pre-stored in the provided 8 MB memory card, the number of storable images will be less than the figure indicated here.

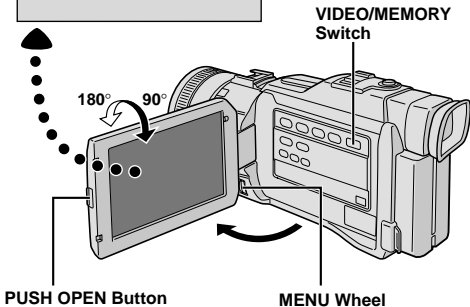
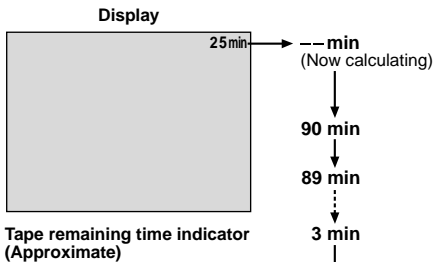
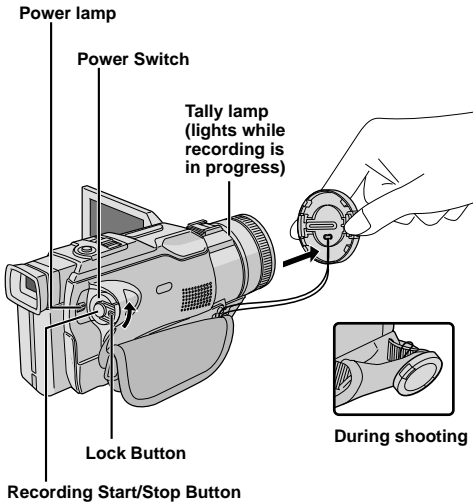

NOTE:

You should already have performed the procedures listed below. If not, do so before continuing.

- Power (☞ pg. 8)
- Grip Adjustment (☞ pg. 10)
- Viewfinder Adjustment (☞ pg. 10)
- Load A Cassette (☞ pg. 12)
- Recording Mode Setting (☞ pg. 15)

1 Press in the tabs on the lens cap to remove it. Press **PUSH OPEN**, open the LCD monitor and set the **VIDEO/MEMORY** Switch to "VIDEO".

2 Set the Power Switch to "A" or "M" while pressing down the Lock Button located on the switch.

Shooting while using the viewfinder: Make sure the LCD monitor is closed and locked. Pull out the viewfinder fully.

- Be sure to pull out the viewfinder until you hear a click, otherwise it may be pushed back in during use.

Shooting while using the LCD monitor: Make sure the LCD monitor is fully open and the viewfinder is pushed back in. Tilt the LCD monitor upward/downward for best viewability.

- The power lamp lights and the camcorder enters the Record-Standby mode. "PAUSE" is displayed.

3 Press the Recording Start/Stop Button. "REC" appears while recording is in progress.

To Stop Recording . . .





..... press the Recording Start/Stop Button. The camcorder re-enters the Record-Standby mode.

To Adjust The Brightness Of The Display

..... rotate the **MENU** wheel until the bright level indicator on the display moves and the appropriate brightness is reached.

- When using the viewfinder, it is also possible to adjust the brightness in this same manner.

NOTES:

- When you use the LCD monitor outdoors in direct sunlight, the LCD monitor may be difficult to see. If this happens, use the viewfinder instead.
- The image will not appear simultaneously in the LCD monitor and the viewfinder except during Interface Shooting. It will appear in the viewfinder when the LCD monitor is in the lock position, and it will appear on the LCD monitor when fully extended.
- The cassette holder cannot be opened unless a power supply is attached.
- There may be a delay after you open the cassette holder cover until the cassette holder opens. Do not use force.
- Once the cassette holder is closed, it recedes automatically. Wait until it recedes completely before closing the cassette holder cover.
- When the Recording Start/Stop button is pressed, it may take a few seconds before actual recording starts. “” starts rotating when the camcorder actually starts recording.
- The time required to calculate and display the remaining tape length, and the accuracy of the calculation, may vary according to the type of tape used.
- “TAPE END” appears when the tape reaches its end, and the power goes off automatically if left in this condition for 5 minutes. “TAPE END” also appears when a cassette at its end is loaded.
- If the Record-Standby mode continues for 5 minutes, the camcorder’s power shuts off automatically. To turn the camcorder on again, push back and pull out the viewfinder again or close and re-open the LCD monitor.
- When a blank portion is left between recorded scenes on the tape, the time code is interrupted and errors may occur when editing the tape. To avoid this, refer to “Recording from the middle of a tape” ( pg. 23).
- During recording, sound is not heard from the speaker. To hear the sound, connect optional headphones to the PHONE connector. The sound volume is at the level it was adjusted to during playback ( pg. 25).
- To turn the tally lamp or beep sounds off,  pg. 28, 30.

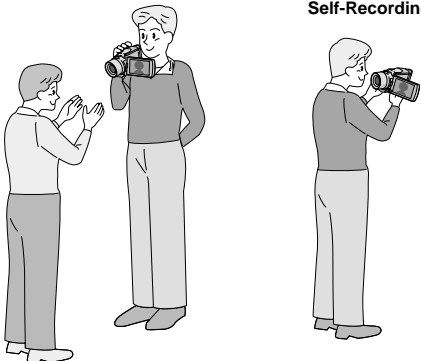
**Self-Recording****JOURNALISTIC SHOOTING**

In some situations, different shooting angles may provide more dramatic results. Hold the camcorder in the desired position and tilt the LCD monitor in the most convenient direction. It can rotate 270° (90° downward, 180° upward).

INTERFACE SHOOTING







The person you shoot can view himself/herself in the LCD monitor, and you can even shoot yourself while viewing your own image in the LCD monitor.

Open the LCD monitor and tilt it upward to 180° so that it faces forward. When the LCD monitor is tilted upward to an angle of over approx. 105°, the monitor image is inverted vertically. If the viewfinder is pulled out at that time, it also switches on.

Point the lens toward the subject (yourself when self-recording) and start recording.

During Interface Shooting, the monitor image and indications do not appear inverted as they would when viewing a mirror.

NOTES:

- During Interface Shooting, the “Tape Running” indicator and warning indications ( pg. 87, 88) are the only ones that are shown; they appear reversed in the display as they would when viewing a mirror, but are not reversed in the recording.
- The tape remaining indicator does not appear during interface shooting. However, when the remaining time reaches 2 minutes, the indicator appears showing the remaining time:  (blinking)  (blinking)  (blinking)  (blinking)  (blinking)  (blinking)

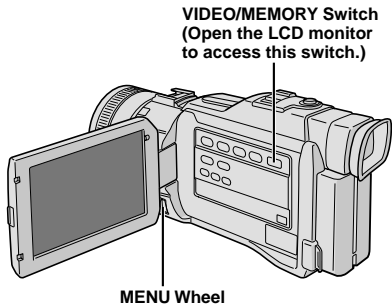
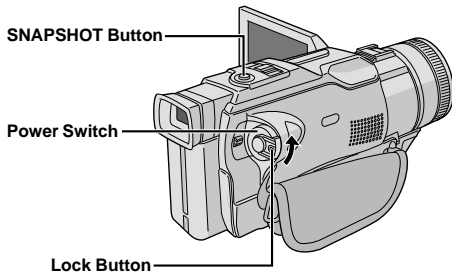

Display

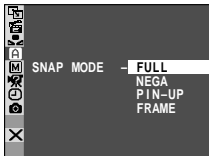

Menu Screen



FULL
Snapshot mode with no
frame*



NEGA
Nega mode*



PIN-UP
Pin-Up mode



FRAME
Snapshot mode with
frame*

Snapshot (For Tape Recording)

This feature lets you record still images that look like photographs onto a tape.

SNAPSHOT MODE SELECTION

- 1 Set the **VIDEO/MEMORY** Switch to "VIDEO", then set the Power Switch to "M" while pressing down the Lock Button located on the switch. Pull out the viewfinder fully or open the LCD monitor fully.
- 2 Press the **MENU** wheel in. The Menu Screen appears.
- 3 Rotate the **MENU** wheel to select "CAMERA". Press it and the CAMERA Menu appears.
- 4 Rotate the **MENU** wheel to select "SNAP MODE", then press it.
- 5 Rotate the **MENU** wheel to select the desired Snapshot mode, then press it. Rotate the **MENU** wheel to select "RETURN" and press it twice. The Menu Screen closes.

SNAPSHOT RECORDING

- 1 Press **SNAPSHOT**.

If you press during Record-Standby . . .

..... "PHOTO" appears and a still image will be recorded for approx. 6 seconds, then the camcorder re-enters the Record-Standby mode.

If you press during Recording . . .

..... "PHOTO" appears and a still image will be recorded for approx. 6 seconds, then the normal recording resumes.

Motor Drive Mode

Keeping **SNAPSHOT** pressed provides an effect similar to serial photography. (Interval between still images: approx. 1 second)

NOTES:

- To remove the shutter sound, "BEEP" on pg. 30.
- If Snapshot recording is not possible, "PHOTO" blinks when **SNAPSHOT** is pressed.
- If Programme AE with special effects (pg. 38) is engaged, certain modes of Programme AE with special effects are disabled during Snapshot recording. In such a case, the icon blinks.
- If **SNAPSHOT** is pressed when "DIS" is set to "ON" (pg. 29), the Stabiliser will be disabled.
- To dub images recorded on a tape to a memory card, pg. 61.
- The Motor Drive mode is disabled when "REC SELECT" is set to "CO" / "M" in the Menu Screen (pg. 31).
- If "REC SELECT" is set to "CO" / "M" in the DSC Menu Screen, still images are recorded on the memory card as well (640 x 480 pixels).
- During playback as well, all snapshot modes except Nega mode are available when "CO" / "M COPY" is set to "OFF" in the Menu Screen (pg. 32).
- When a headphone set is connected to the PHONE connector, the shutter sound is not heard from the speaker, however it is recorded onto the tape.

* There is the sound effect of a shutter closing.

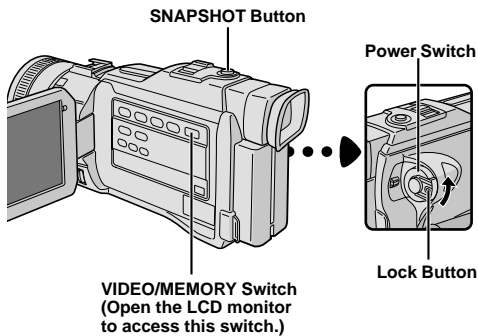

Basic Shooting (Snapshot)

You can use your camcorder as a Digital Still Camera for taking snapshots.

NOTE:

You should already have performed the procedures listed below. If not, do so before continuing.

- Power (☞ pg. 8)
- Grip Adjustment (☞ pg. 10)
- Viewfinder Adjustment (☞ pg. 10)
- Loading A Memory Card (☞ pg. 13)
- Picture Quality/Image Size Setting (☞ pg. 16)

1 Set the **VIDEO/MEMORY Switch** to “MEMORY”, then set the Power Switch to “A” or “M” while pressing down the Lock Button located on the switch. Open the LCD monitor fully or pull out the viewfinder fully.

2 Press **SNAPSHOT**.

The image is recorded on the memory card.

- To check how the image looks before recording it on the memory card, press **SNAPSHOT** halfway and hold. “A” appears and stops blinking when the captured image is focused. To cancel it, release **SNAPSHOT**. To record it on the memory card, press **SNAPSHOT** fully.
- Still images are recorded in the snapshot mode with no frame.

To Delete Unwanted Still Images . . .

..... when unwanted still images are stored in the memory card or its memory is full, refer to “Deleting Files” (☞ pg. 50) and delete unwanted still images.

To Remove The Shutter Sound . . .

..... when you do not want to hear the shutter sound, set “BEEP” to “OFF” in the Menu Screen (☞ pg. 28, 30). The sound is no longer heard from the speaker.

NOTES:

- Even if “DIS” is set to “ON” (☞ pg. 29), the Stabiliser will be disabled.
- If Snapshot recording is not possible, “PHOTO” blinks when **SNAPSHOT** is pressed.
- If Programme AE with special effects (☞ pg. 38) is engaged, certain modes of Programme AE with special effects are disabled during Snapshot recording. In such a case, the icon blinks.
- If shooting is not performed for approx. 5 minutes when the Power Switch is set to “A” or “M” and power is supplied from the battery pack, the camcorder shuts off automatically to save power. To perform shooting again, close the LCD monitor and re-open it. When using the viewfinder, push back it in and pull it out again.
- The Motor Drive mode (☞ pg. 20) is disabled when the **VIDEO/MEMORY Switch** is set to “MEMORY”.
- When a headphone set is connected to the PHONE connector, the shutter sound is not heard from the speaker.
- Still images taken are compliant to DCF (Design rule for Camera File system). They do not have any compatibility with devices which are not compliant to DCF.

Image Size

Displays the image file size: 1600 (1600 x 1200), 1280 (1280 x 960), 1024 (1024 x 768) or 640 (640 x 480) (☞ pg. 16).

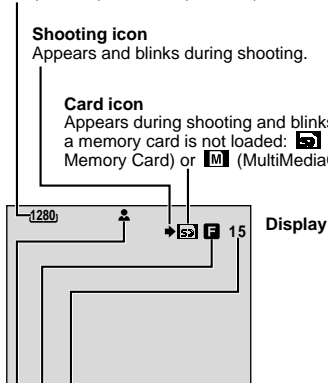

Shooting icon

Appears and blinks during shooting.

Card icon

Appears during shooting and blinks when a memory card is not loaded: (SD Memory Card) or (MultiMediaCard).

Remaining number of shots

Displays the remaining number of shots that can be stored. The number increases or decreases depending on the Picture Quality/Image Size, etc.

Picture Quality

Displays the quality of image: F (Fine) or S (Standard) (in order of quality) (☞ pg. 16).

Focus icon

Blinks while the focus is being adjusted and stops blinking when the focus is locked.



Snapshot mode with no frame

There is the sound of a shutter closing.

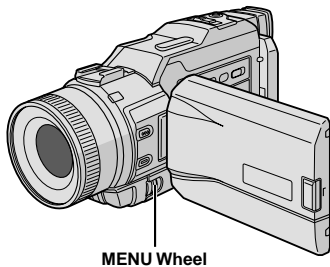
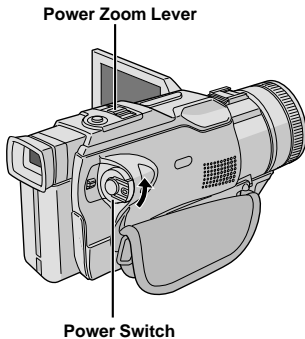
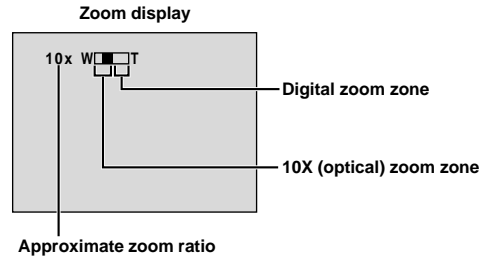
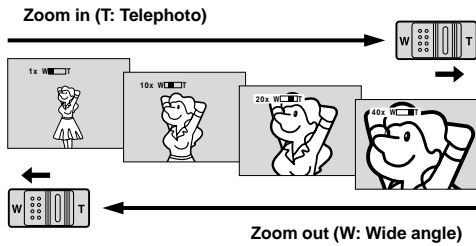

FEATURE: Zooming

PURPOSE:

To produce the zoom in/out effect, or an instantaneous change in image magnification.

OPERATION:

Zoom In

Slide the Power Zoom Lever towards "T".

Zoom Out

Slide the Power Zoom Lever towards "W".

■ The further you slide the Power Zoom Lever, the quicker the zoom action.

NOTES:

- Focusing may become unstable during Zooming. In this case, set the zoom while in Record-Standby, lock the focus by using the manual focus (☞ pg. 24), then zoom in or out in Record mode.
- Zooming is possible to a maximum of 300X, or it can be switched to 10X magnification using the optical zoom (☞ pg. 29).
- Zoom magnification of over 10X is done through Digital image processing, and is therefore called Digital Zoom.
- During Digital zoom, the quality of image may suffer.
- Digital zoom cannot be used when the VIDEO/MEMORY Switch is set to "MEMORY" (☞ pg. 14).
- Macro shooting (as close as approx. 5 cm to the subject) is possible when the Power Zoom Lever is set all the way to "W". Also see "TELE MACRO" in the Menu Screen on page 30.

NOTE: Recording From The Middle Of A Tape

Time Code

During recording, a time code is recorded on the tape. This code is to confirm the location of the recorded scene on the tape during playback.

If recording starts from a blank portion, the time code begins counting from "00:00:00" (minute:second:frame). If recording starts from the end of a previously recorded scene, the time code continues from the last time code number.

To perform Random Assemble Editing (☞ pg. 66 – 70), time code is necessary. If during recording a blank portion is left partway through the tape, the time code is interrupted. When recording is resumed, the time code starts counting up again from "00:00:00". This means the camcorder may record the same time codes as those existing in a previously recorded scene. To prevent this, perform "Recording From The Middle of A Tape" below in the following cases;

- When shooting again after playing back a recorded tape.
- When power shuts off during shooting.
- When a tape is removed and re-inserted during shooting.
- When shooting using a partially recorded tape.
- When shooting on a blank portion located partway through the tape.
- When shooting again after shooting a scene then opening/closing the cassette holder cover.

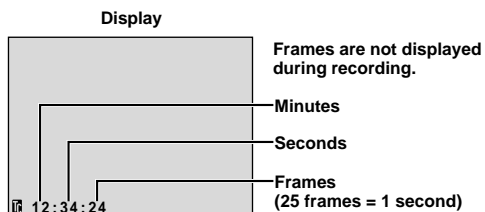

Recording From The Middle Of A Tape

1. Play back a tape or use Blank Search (☞ pg. 44) to find the spot at which you want to start recording, then engage the Still Playback mode (☞ pg. 25).
2. Set the Power Switch to "A" or "M" while pressing down the Lock Button located on the switch, then start recording.

NOTES:

- The time code cannot be reset.
- During fast-forwarding and rewinding, the time code indication does not move smoothly.
- The time code is displayed only when "TIME CODE" is set to "ON" (☞ pg. 31, 32).

When a blank portion is recorded on a tape

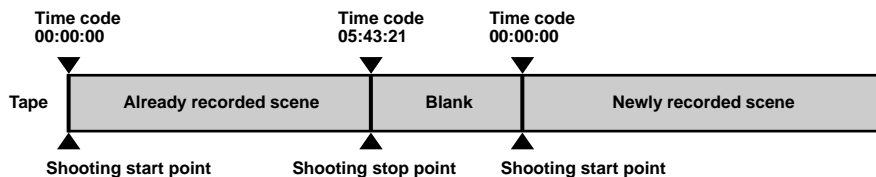

Proper recording

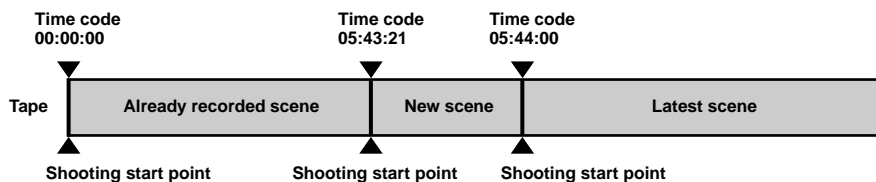

Focus detection zone

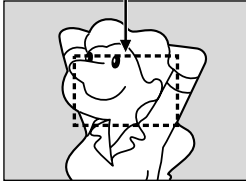

While focusing on a further subject

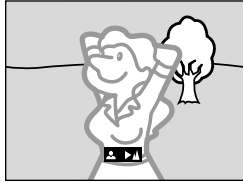

While focusing on a nearer subject

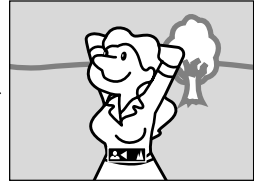
**FEATURE: Auto Focus****PURPOSE:**

The camcorder's Full Range AF system offers continuous shooting ability from close-up (as close as approx. 5 cm to the subject) to infinity.

However, correct focus may not be obtainable in the situations listed below (in these cases use manual focusing):

- When two subjects overlap in the same scene.
- When illumination is low.*
- When the subject has no contrast (difference in brightness and darkness), such as a flat, one-colour wall, or a clear, blue sky.*
- When a dark object is barely visible in the viewfinder.*
- When the scene contains minute patterns or identical patterns that are regularly repeated.
- When the scene is affected by sunbeams or light reflecting off the surface of a body of water.
- When shooting a scene with a high-contrast background.

* The following low-contrast warnings appear blinking: ▲, ◀, ▶ and 👤

NOTES:

- If the lens is smeared or blurred, accurate focusing is not possible. Keep the lens clean, wiping with a piece of soft cloth if it gets dirty. When condensation occurs, wipe with a soft cloth or wait for it to dry naturally.
- When shooting a subject close to the lens, zoom out first (⏪ pg. 22). If zoomed-in in the auto focus mode, the camcorder may automatically zoom out depending on the distance between the camcorder and the subject. This will not occur when "TELE MACRO" (⏪ pg. 30) is activated.

FEATURE: Manual Focus**PURPOSE:**

To obtain correct focus.

OPERATION:

- 1) If you are using the viewfinder, you should already have made the necessary viewfinder adjustments (⏪ pg. 10).
- 2) Set the Power Switch to "📷" while pressing down the Lock Button located on the switch, then press **FOCUS** (⏪ pgs. 82 and 83, Ⓜ FOCUS Button). The manual focus indicator appears.
- 3) To focus on a farther subject, rotate the Focus Ring clockwise. "▶" appears and blinks.
To focus on a nearer subject, rotate the Focus Ring counterclockwise. "◀" appears and blinks.

To reset to Auto Focus, press **FOCUS** or set the Power Switch to "📷".

NOTES:

- Be sure to focus the lens in the maximum telephoto position when you use the Manual Focus mode. If you focus in on a subject in the wide-angle position, sharply focused images cannot be obtained when zoomed up because the depth-of-field is reduced at longer focal lengths.
- When the focus level cannot be adjusted any further or closer, "▲" or "👤" will blink.

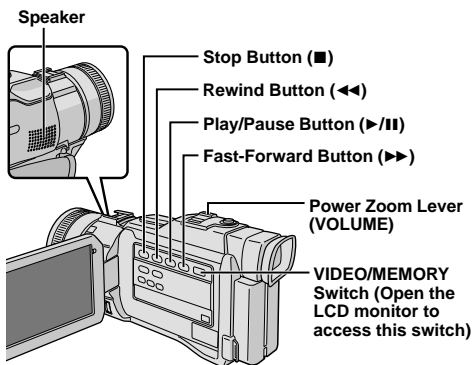

- 1** Load a tape (☞ pg. 12).
- 2** Set the **VIDEO/MEMORY** Switch to "VIDEO", then set the Power Switch to "PLAY" while pressing down the Lock Button located on the switch. To start playback, press ▶/||.
 - To stop playback, press ■.
 - Press ◀◀ to rewind, or ▶▶ to fast-forward the tape during Stop mode.

To Control The Speaker Volume . . .
 slide the Power Zoom Lever (**VOLUME**) towards "+" to turn up the volume, or towards "-" to turn down the volume.

NOTES:

- If Stop mode continues for 5 minutes when power is supplied from a battery, the camcorder shuts off automatically. To turn on again, set the Power Switch to "OFF", then to "PLAY".
- The playback picture can be viewed in the LCD monitor, viewfinder or on a connected TV (☞ pg. 54).
- You can also view the playback picture on the LCD monitor with it flipped over and pushed against the camera body.
- LCD monitor/viewfinder indications:
 - When power is supplied from a battery: the "☐" battery pack remaining power indicator is displayed. When power is supplied through the DC cord: "☐" does not appear.
 - During Stop mode, none of the indications are displayed.
- When a cable is connected to the AV or PHONE connector, the sound is not heard from the speaker.

Still Playback: Pauses during playback.

- 1) Press ▶/|| during playback.
 - 2) To resume normal playback, press ▶/|| again.
- If still playback continues for more than about 3 minutes, the camcorder's Stop mode is automatically engaged. After 5 minutes in the Stop mode, the camcorder's power is automatically turned off.
 - When ▶/|| is pressed, the image may not pause immediately while the camcorder stabilises the still image.

Shuttle Search: Allows high-speed search in either direction.

- 1) Press ▶▶ for forward or ◀◀ for reverse search during playback.
 - 2) To resume normal playback, press ▶/||.
- During playback, press and hold ◀◀ or ▶▶. The search continues as long as you hold the button. Once you release it, normal playback resumes.
 - A slight mosaic effect appears on screen during Shuttle Search. This is not a malfunction.

Frame-By-Frame Playback: Allows frame-by-frame search.

- 1) Engage Still Playback.
 - 2) Rotate the **MENU** wheel towards "▲" for forward Frame-By-Frame Playback, or towards "▼" for reverse Frame-By-Frame Playback during Still Playback.
- To resume normal playback, press ▶/||.
 - You can also use the provided remote control for Frame-By-Frame Playback (☞ pg. 64).

Slow-Motion Playback, Playback Zoom and Playback Special Effects

Available only with the remote control (provided) (☞ pg. 64, 65).

ATTENTION

During Shuttle Search, parts of the picture may not be clearly visible, particularly on the left side of the screen.



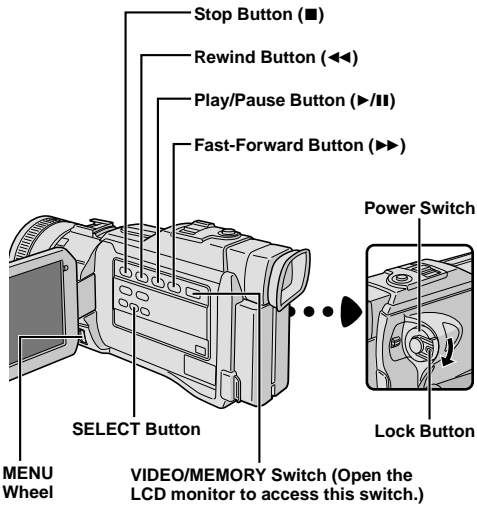

[For Normal Playback: IMAGE]

To display the next image

To display the previous image

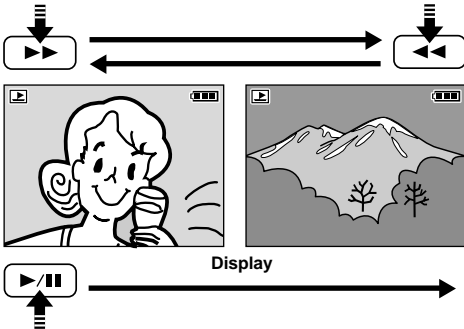

[For Auto Playback: IMAGE]

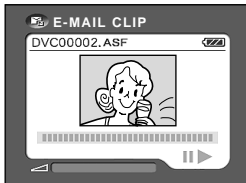

Normal Playback:
E-MAIL CLIP

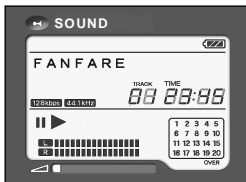

Normal Playback:
SOUND

Normal Playback

- 1 Load a memory card (pg. 13).
- 2 Set the **VIDEO/MEMORY** Switch to "MEMORY", then set the Power Switch to "**PLAY**" while pressing down the Lock Button located on the switch.
 - A stored file is displayed.
- 3 Press **SELECT**. The MEMORY SELECT Screen appears. Rotate the **MENU** wheel to select the type of file: **IMAGE**, **E-MAIL CLIP** (pg. 46), **SOUND** (pg. 45) or **TITLE** (pg. 48). Then press the **MENU** wheel in. The selected type of file is displayed.

4 If you are viewing an IMAGE file . . .

Press ▶▶ to display the next image, or press ◀◀ to display the previous image.

If you are viewing an E-MAIL CLIP file . . .

Press ▶/|| to play back the displayed video clip. To stop video clip playback, press ■.

If you are listening to a SOUND file . . .

Press **D.SOUND** to play back the displayed sound effect.

- Pressing **INFO** gives you details on the displayed file (pg. 27, "Viewing File Information").
- You can also overview several files at a time (pg. 27, Index Playback).
- You can turn off the on-screen playback display (pg. 27, "Removing On-Screen Display").

Auto Playback

You can run through all the files stored on the memory card automatically.

NOTE:

Auto Playback does not work with video clips.

- 1 Perform steps 1 and 2 above.
- 2 Press ▶/||.
 - If you press ◀◀ during Auto Playback, files are displayed in descending order.
 - If you press ▶▶ during Auto Playback, files are displayed in ascending order.

3 To end Auto Playback, press ■.

NOTE:

Even if you shoot a new image after playing back a low-numbered one, this will not overwrite an existing image, because new images are automatically stored after the last-recorded one.

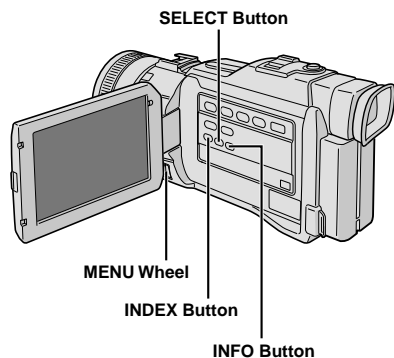

Selected file

Index number



Index Screen: IMAGE



Info Screen: IMAGE

Operation mode indicator

Battery indicator



Playback Screen



Menu Screen

Index Playback

You can view several different files stored on the memory card at a time. This browsing capability makes it easy to locate a particular file you want.

- 1 Perform steps 1 through 3 of "Normal Playback".
- 2 Press **INDEX**. The Index Screen appears.
- 3 Rotate the **MENU** wheel to move the frame to the desired file.
 - Pressing **▶▶** displays the next page and **◀◀** displays the previous page.
 - Pressing **INFO** gives you details on the currently selected file (☞ "Viewing File Information").
- 4 Press the **MENU** wheel in. The selected file is displayed.
 - Pressing **INFO** gives you details on the displayed file (☞ "Viewing File Information").

Viewing File Information

You can get the relevant file information by pressing the **INFO** button during normal playback or Index playback.

- DCF : Folder and file number (IMAGE files only)
- FOLDER : Folder name (☞ pg. 51)
- FILE : File name (☞ pg. 51)
- DATE : Date the file was made
- SIZE : Image size (except SOUND files)
(☞ pg. 16, 46)
- QUALITY : Picture quality (IMAGE files only)
(☞ pg. 16)
- TIME : Playback time (E-MAIL CLIP/SOUND files only) (☞ pg. 46)
- PROTECT : When set to ON, the file is protected from accidental erasure (☞ pg. 49).
- Press **INFO** again to close the Info Screen.

NOTE:

With images shot with another device or processed on a PC, "QUALITY: ---" will be displayed.

Removing On-Screen Display

- 1 Perform steps 1 and 2 of "Normal Playback" (☞ pg. 26).
- 2 Press **SELECT**. The MEMORY SELECT Screen appears. Rotate the **MENU** wheel to select IMAGE or TITLE, then press it.
 - A stored IMAGE (📷) or TITLE (💬) file is displayed.
- 3 Press the **MENU** wheel in. The Menu Screen appears. Rotate the **MENU** wheel to select "DISPLAY", then press it.
- 4 Rotate the **MENU** wheel to select "OFF", then press it. The operation mode indicator and battery indicator (🔋) disappear.
 - To display the indicators again, select "ON" in step 4.

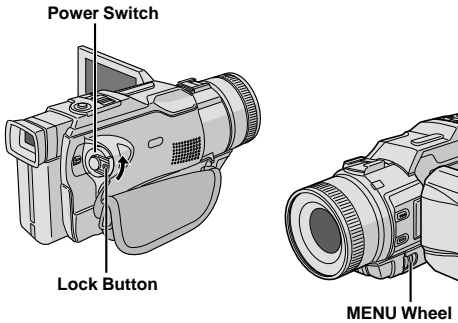

For Recording Menu

This camcorder is equipped with an easy-to-use, on-screen menu system that simplifies many of the more detailed camcorder settings (pg. 29 – 31).

- 1** Set the Power Switch to “**M**” while pressing down the Lock Button located on the switch, then pull out the viewfinder fully or open the LCD monitor fully.
- 2** Press the **MENU** wheel in. The Menu Screen appears.
- 3** Rotate the **MENU** wheel to select the desired function menu, and press it. The selected function menu appears.
- 4** Function menu setting depends on the function.

If you have selected “**FADER/WIPE**”, “**PROGRAM AE**” or “**W. BALANCE**” ...
..... see pg. 29.

If you have selected “**CAMERA**”, “**MANUAL**”, “**SYSTEM**”, “**DISPLAY**” or “**DSC**” ...
..... go to step 5.





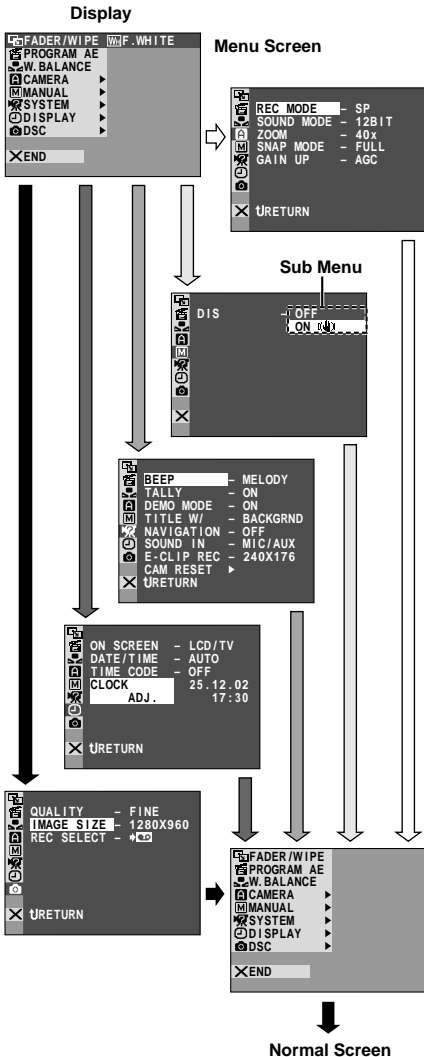









- 5** Rotate the **MENU** wheel to select the desired function and press it. The Sub Menu appears. Then, rotate the **MENU** wheel to select the parameter, and press it. Selection is complete.

- 6** Rotate the **MENU** wheel to select “**RETURN**” and press it twice. The Menu Screen closes.
 - The **X** icon represents “END”.



Normal Screen

Menu Screen Explanations

 FADER/WIPE		Refer to "Fade/Wipe Effects" ( pg. 36, 37).	
 PROGRAM AE		Refer to "Programme AE With Special Effects" ( pg. 38, 39).	
 W.BALANCE		Refer to "White Balance Adjustment" and "Manual White Balance Operation" ( pg. 41).	
CAMERA	REC MODE	Allows you to set the tape recording mode (SP or LP) depending on your preference ( pg. 15).	
	SOUND MODE	12BIT	Enables tape recording of stereo sound on four separate channels, and is recommended for use when performing audio dubbing. (Equivalent to the 32 kHz mode of previous models)
		16BIT	Enables tape recording of stereo sound on two separate channels. (Equivalent to the 48 kHz mode of previous models)
	ZOOM	10X	When set to "10X" while using digital zoom, the zoom magnification will reset to 10X since digital zoom will be disengaged.
		40X	Allows you to use the Digital Zoom. By digitally processing and magnifying images, zooming is possible from 10X (the optical zoom limit), to a maximum of 40X digital magnification.
		300X	Allows you to use the Digital Zoom. By digitally processing and magnifying images, zooming is possible from 10X (the optical zoom limit), to a maximum of 300X digital magnification.
	SNAP MODE		Refer to "Snapshot (For Tape Recording)" ( pg. 20).
GAIN UP	OFF	Allows you to shoot dark scenes with no picture brightness adjustment.	
	AGC	The overall appearance may be grainy, but the image is bright.	
MANUAL	DIS	OFF	To compensate for unstable images caused by camera-shake, particularly at high magnification. NOTES: <ul style="list-style-type: none"> ● Accurate stabilisation may not be possible if hand shake is excessive, or under the following conditions: <ul style="list-style-type: none"> • When shooting subjects with vertical or horizontal stripes. • When shooting dark or dim subjects. • When shooting subjects with excessive backlighting. • When shooting scenes with movement in various directions. • When shooting scenes with low-contrast backgrounds. ● Switch off this mode when recording with the camcorder on a tripod. ● The " " indicator blinks or goes out if the Stabiliser cannot be used.
		ON 	
	SELF-TIMER		Refer to "Self-Timer" ( pg. 34).
	 5S	OFF	Refer to "5-Second Recording" ( pg. 35).
		5S	
		Anim.	Allows you to record a few frames only. By using an inanimate object and changing its position between shots, you can record the subject as though it is moving ( pg. 35).
	TELE MACRO	OFF	Usually the distance to a subject where the lens is in focus depends on the zoom magnification. Unless there is a distance more than 1m to the subject, the lens is out of focus at the maximum telephoto setting. When set to "ON", you can shoot a subject as large as possible at a distance of approx. 60 cm. <ul style="list-style-type: none"> • Depending on the zoom position, the lens may go out of focus.
		ON	

NOTES:

- Settings made in the "**CAMERA**" Menu remain effective whether the Power Switch is set to "**CAMERA**" or "**MANUAL**". However, the menu settings can be changed only when the Power Switch is set to "**MANUAL**".
- The "**MANUAL**" settings are effective only when the Power Switch is set to "**MANUAL**".

 : Factory-preset







CONTINUED ON NEXT PAGE

Menu Screen Explanations (cont.)

MANUAL	WIDE MODE	OFF	Records with no change in the screen ratio. For playback on a TV with a normal screen ratio.
		CINEMA <input type="checkbox"/>	Inserts black bands at the top and bottom of the screen. During playback on wide-screen TVs, the black bands at the top and bottom of the screen are cut and the screen ratio becomes 16:9. <input type="checkbox"/> appears. When using this mode, refer to your wide-screen TV's instruction manual. During playback/recording on 4:3 TVs/LCD monitor/viewfinder, black bands are inserted at the top and bottom of the screen and the image appears like a letterboxed 16:9 movie. • "CINEMA" mode is effective only when the VIDEO/MEMORY Switch is set to "VIDEO" (☞ pg. 14).
		SQUEEZE <input checked="" type="checkbox"/>	For playback on TVs with an aspect ratio of 16:9. Naturally expands the image to fit the screen without distortion. <input checked="" type="checkbox"/> appears. When using this mode, refer to your wide-screen TV's instruction manual. During playback/recording on 4:3 TVs/LCD monitor/viewfinder, the image is elongated vertically. • "SQUEEZE" mode is effective only when the VIDEO/MEMORY Switch is set to "VIDEO" (☞ pg. 14).
		D.WIDE <input checked="" type="checkbox"/>	" <input checked="" type="checkbox"/>
	WIND CUT	OFF	Disengages the function which cuts down on noise created by wind.
		ON <input checked="" type="checkbox"/>	Helps cut down on noise created by wind. " <input checked="" type="checkbox"/>
SYSTEM	BEEP	OFF	Even though not heard while shooting, shutter sound is recorded on the tape.
		BEEP	The beep sounds when the power is turned on or off, and at the beginning and end of recording. Also to activate the shutter sound effect (☞ pg. 20, 21).
		MELODY	Instead of a beep, a melody sounds when any operation is performed. It also activates the shutter sound effect (☞ pg. 20, 21).
	TALLY	OFF	The tally lamp remains off at all times.
		ON	The tally lamp comes on to signal the start of recording.
	DEMO MODE	OFF	Automatic demonstration will not take place.
		ON	Demonstrates certain functions such as Programme AE with special effects, etc., and can be used to confirm how these functions operate. Demonstration starts in the following cases: • When the Menu Screen is closed after "DEMO MODE" is turned "ON". • With "DEMO MODE" set to "ON", if there is no operation for about 3 minutes after the Power Switch is set to "A" or "M". Performing any operation during the demonstration stops the demonstration temporarily. If no operation is performed for more than 3 minutes after that, the demonstration will resume. NOTES: • If a tape is in the camcorder, the demonstration cannot be turned on. • "DEMO MODE" remains "ON" even if the camcorder power is turned off. • If "DEMO MODE" remains "ON", some functions will not be available. After viewing demo, set to "OFF".

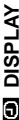
 : Factory-preset
NOTES:

- The " MANUAL" settings are effective only when the Power Switch is set to "".
- " SYSTEM" functions which are set when the Power Switch is set to "" are also applied when the Power Switch is set to "PLAY" (☞ pg. 32).

	TITLE W/		Refer to "Title Impose" (☞ pg. 48).
	NAVIGATION		Refer to "NAVIGATION Function" (☞ pg. 42).
	SOUND IN		Refer to "Audio Dubbing Using Digital Sound Effects" (☞ pg. 73).
	E-CLIP REC		Refer to "E-Mail Clip Recording" (☞ pg. 46).
	CAM RESET	CANCEL	Does not reset all settings to the factory-preset.
		EXECUTE	Resets all settings to the factory-preset.
	ON SCREEN	LCD	Keeps the camcorder's display (except the date, time and time code) from appearing on the connected TV screen.
		LCD/TV	Makes the camcorder's display appear on screen when the camcorder is connected to a TV.
	DATE/TIME	OFF	The date/time does not appear.
		AUTO	Displays the date/time for approx. 5 seconds in the following cases: <ul style="list-style-type: none"> • When the Power Switch is set from "OFF" to "A" or "M". • When tape playback starts. The camcorder displays the date/time when scenes are recorded. • When the date is changed during tape playback.
		ON	The date/time is always displayed.
	TIME CODE	OFF	Time code is not displayed.
		ON	Time code is displayed on the camcorder and on the connected TV. Frame numbers are not displayed during recording.
CLOCK ADJ.		Allows you to set the current date and time (☞ pg. 11).	
	QUALITY		Refer to "Picture Quality/Image Size Setting" (☞ pg. 16).
	IMAGE SIZE		
	REC SELECT		When Snapshot recording is performed with the VIDEO/MEMORY Switch set to "VIDEO", still images are recorded only onto the tape.
		 / 	When Snapshot recording is performed with the VIDEO/MEMORY Switch set to "VIDEO", still images are recorded not only onto the tape but also on the memory card (640 X 480 pixels). In this mode, the "SNAP MODE" selection in the CAMERA Menu is also applicable to memory card recording.

 : Factory-preset

NOTES:

- "SYSTEM" and "DISPLAY" functions which are set when the Power Switch is set to "M" are also applied when the Power Switch is set to "PLAY" (☞ pg. 32). "CLOCK ADJ." only appears when the Power Switch is set to "M".
- Settings made in the "DISPLAY" Menu remain effective even when the Power Switch is set to "A". However, the menu settings can be changed only when the Power Switch is set to "M".
- The date indication can also be turned on/off by pressing the **DISPLAY** Button on the remote control (provided) (☞ pg. 55, 58, 67).

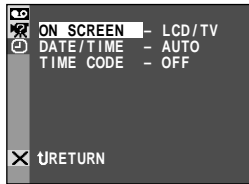
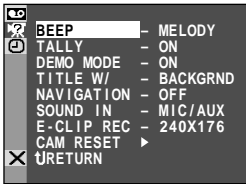
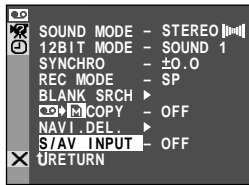
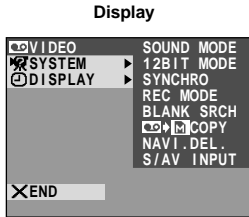
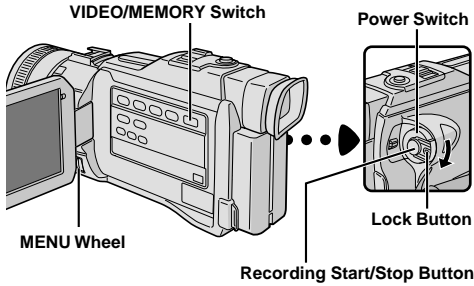

For Playback Menu

The following procedure applies to all except Synchro Comp (☞ pg. 70).

- 1** Set the VIDEO/MEMORY Switch to "VIDEO", then set the Power Switch to "PLAY" while pressing down the Lock Button located on the switch.
- 2** Press the MENU wheel in. The Menu Screen appears.
- 3** Rotate the MENU wheel to select the desired function menu, and press it. The selected function menu appears.
- 4** Rotate the MENU wheel to select the desired function, and press it to display the Sub Menu.
- 5** Rotate the MENU wheel to select the desired parameter and press it. Selection is complete.
- 6** Rotate the MENU wheel to select "RETURN" and press it twice to close the Menu Screen.

Menu Screen Explanations



VIDEO	SOUND MODE	☞ pg. 33.
	12BIT MODE	☞ pg. 33.
	SYNCHRO	☞ pg. 70.
	REC MODE	Allows you to set the tape recording mode (SP or LP) depending on your preference (☞ pg. 15). It is recommended you use "REC MODE" in the "VIDEO" Menu when using this camcorder as a recorder during dubbing (☞ pg. 59, 60).
	BLANK SRCH	Helps find a blank portion of tape when you want to record from the middle of a tape (☞ pg. 44).
	COPY	IMAGE: Enables dubbing of images recorded on a tape to a memory card (☞ pg. 61). OFF: Enables snapshots to be taken during tape playback. NAVIGATION: Enables thumbnail images to be made manually during tape playback (☞ pg. 43).
	NAVI.DEL.	☞ pg. 43.
SYSTEM	S/AV INPUT	ON: Enables audio/video signal input from the AV and S-VIDEO connectors (☞ pg. 59). OFF: Enables audio/video signal output to a TV, VCR, etc. via the AV and S-VIDEO connectors (☞ pg. 54, 58).
	DISPLAY	Each setting is linked with "DISPLAY" or "SYSTEM", which appears when the Power Switch is set to "M" (☞ pg. 30, 31). The parameters are the same as in the description on pg. 30, 31.

NOTES:

- The date indication can also be turned on/off by pressing DISPLAY on the remote control (provided).
- "REC MODE" can be set when the Power Switch is set to "PLAY" or "M" (☞ pg. 15, 29).
- When "S/AV INPUT" is set to "ON", camcorder playback cannot be viewed on the AV output.

Playback Sound

During tape playback, the camcorder detects the sound mode in which the recording was made, and plays the sound back. Select the type of sound to accompany your playback picture. According to the menu access explanation on pg. 32, select "SOUND MODE" or "12BIT MODE" from the Menu Screen and set it to the desired parameter.

SOUND MODE	STEREO 	Sound is output on both "L" and "R" channels in stereo.
	SOUND L 	Sound from the "L" channel is output in stereo.
	SOUND R 	Sound from the "R" channel is output in stereo.
12BIT MODE	MIX	Original and dubbed sounds are combined and output in stereo on both "L" and "R" channels in stereo.
	SOUND 1	Original sound is output on both "L" and "R" channels in stereo.
	SOUND 2	Dubbed sound is output on both "L" and "R" channels in stereo.

 : Factory-preset

NOTES:

- The "SOUND MODE" setting is available for both 12-bit and 16-bit sound. (In previous models' functions, "12-bit" is called "32 kHz" and "16-bit" is called "48 kHz".)
- The camcorder cannot detect the sound mode in which the recording was made during fast-forward or rewind. During playback the sound mode is displayed in the upper left corner.

Display

ON SCREEN setting:
For playback sound, tape speed and tape running.

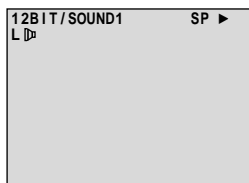

DATE/TIME setting:
For date/time.

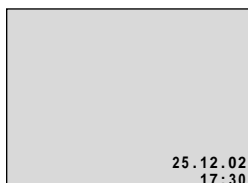

TIME CODE setting:
For time code.

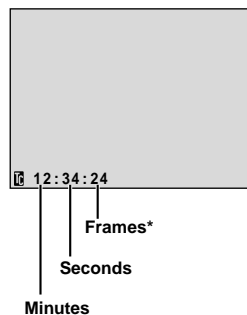

*25 frames = 1 second

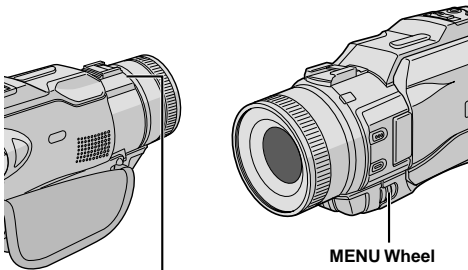
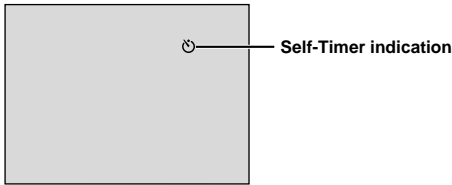
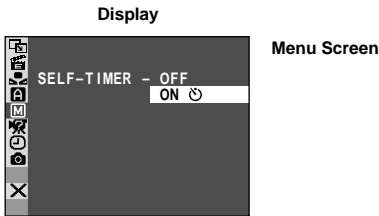
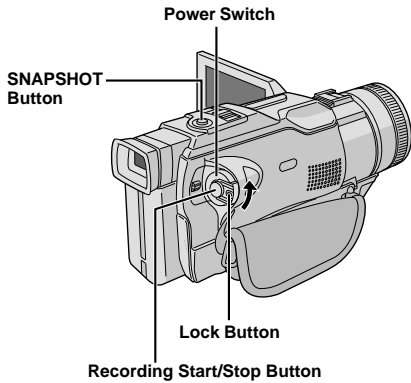

When the Recording Start/Stop Button or SNAPSHOT is pressed, the tally lamp changes as shown:

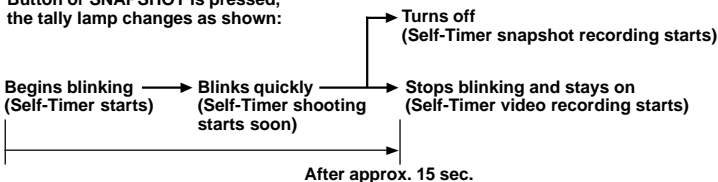

Self-Timer

Once the camcorder is set, the camcorder operator can become part of the scene in a more natural way, adding the final touch to a memorable picture.

- 1** Set the Power Switch to "M" while pressing down the Lock Button located on the switch. Pull out the viewfinder fully or open the LCD monitor fully.
 - You can tilt the LCD monitor upward to 180° so that it faces forward and view yourself while self-recording with the viewfinder pushed back.
- 2** Press the MENU wheel in. The Menu Screen appears.
- 3** Rotate the MENU wheel to select "M MANUAL", and press it.
- 4** Rotate the MENU wheel to select "SELF-TIMER", and press it. The Sub Menu appears. Rotate the MENU wheel to select "ON ☺", and press it. Selection is complete. Rotate the MENU wheel to select "RETURN", and press it twice to close the Menu Screen.

5 To engage the Self-Timer for video recording, press the Recording Start/Stop Button. After 15 seconds, the beep sounds and video recording starts. To stop Self-Timer recording, press the Recording Start/Stop Button again. The camcorder re-enters Record-Standby mode.

OR

Press SNAPSHOT. After 15 seconds, the beep sounds and snapshot recording starts. After that, the camcorder re-enters Record-Standby mode.

6 To end Self-Timer recording, select "OFF" in step 4.

NOTE:

If "BEEP" and "TALLY" are set to "OFF" (pg. 30), the beep does not sound and the tally lamp does not light.

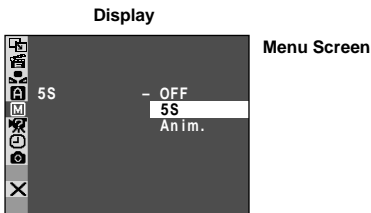
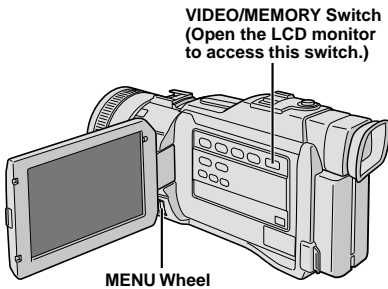
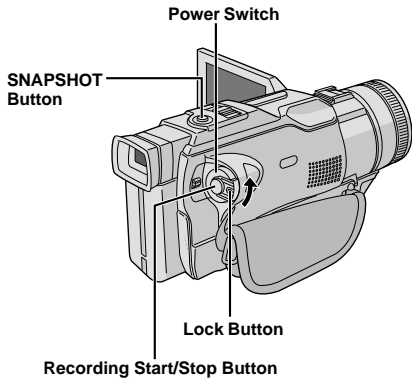

5-Second Recording

Record a vacation or an important event in 5-second clips to keep the action moving. This function is available only for tape recording.

1 Set the **VIDEO/MEMORY** Switch to "VIDEO", then set the Power Switch to "M" while pressing down the Lock Button located on the switch. Pull out the viewfinder fully or open the LCD monitor fully.

2 Press the **MENU** wheel in. The Menu Screen appears.

3 Rotate the **MENU** wheel to select "M MANUAL", and press it. The MANUAL Menu appears.

4 Rotate the **MENU** wheel to select "5S", and press it. The Sub Menu appears.

5 Rotate the **MENU** wheel to select "5S", and press it. Selection is complete. Rotate the **MENU** wheel to select "RETURN", and press it twice to close the Menu Screen.

• "5S" appears.

6 Press the Recording Start/Stop Button. The tally lamp lights and beep sounds to indicate the start of recording, and after 5 seconds the camcorder enters Record-Standby mode.

• Even if you press the Recording Start/Stop Button again within 5 seconds after recording starts, Record-Standby mode is not engaged.

7 To exit the 5S mode, select "OFF" in step 5.

To Take A Snapshot In The 5-Second Recording Mode . . .

..... Instead of pressing the Recording Start/Stop Button in step 6, select the desired Snapshot mode in the Menu Screen, then press **SNAPSHOT**. The camcorder records a 5-second still (pg. 20). When "5S" is set to "Anim." (pg. 29) this function is not available.

NOTE:

When "5S" is set to "Anim." in the Menu Screen the 5-second recording mode is not available. Animation recording of a few frames only is taken instead (pg. 29).

IMPORTANT

Some Fade/Wipe Effects cannot be used with certain modes of Programme AE with special effects (see pg. 38, 39). If an unusable Fade/Wipe Effect is selected, its indicator blinks or goes out.

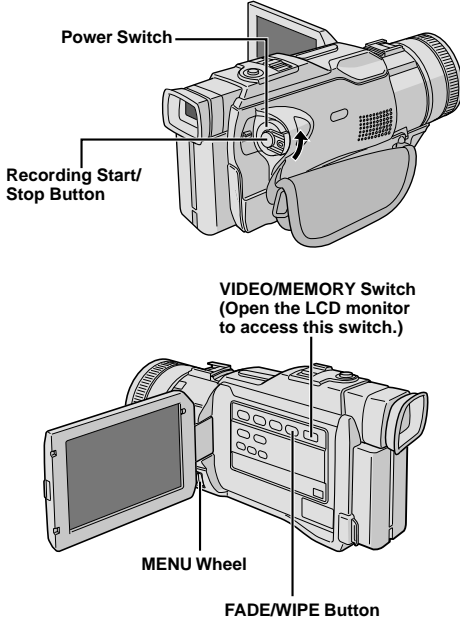
**To Deactivate The Selected Effect . . .**

..... press **FADE/WIPE** again in step 6 so that the effect indicator disappears.

Fade/Wipe Effects

These effects let you make pro-style scene transitions. Use them to spice up the transition from one scene to the next.

Fade or Wipe works when tape recording is started or when you stop recording.

1 Set the **VIDEO/MEMORY** Switch to "VIDEO" and set the Power Switch to "M" while pressing down the Lock Button located on the switch. Pull out the viewfinder fully or open the LCD monitor fully.

2 Press the **MENU** wheel in. The Menu Screen appears.

3 Rotate the **MENU** wheel to select "FADER/WIPE", then press it. Rotate the **MENU** wheel to select the desired function, then press it. Selection is complete.

4 Press the **MENU** wheel in again. The Menu Screen closes.

5 **To activate the Fade-in or Wipe-in . . .**

..... Press **FADE/WIPE** during Record-Standby mode so that the selected effect indicator appears.

To activate the Fade-out or Wipe-out . . .









..... Press **FADE/WIPE** during recording so that the selected effect indicator appears.

6 Press the Recording Start/Stop Button to activate the Fade-in/out or Wipe-in/out.

NOTES:

- Once a Fade/Wipe Effect is executed, the effect is deactivated and its indicator goes out. To use the same effect again, press **FADE/WIPE** as required. To use a different effect, start from step 3.
- You can extend the length of a Fade or Wipe by pressing and holding the Recording Start/Stop Button.
- The sound at the end of the last recorded scene is not stored.

Fader And Wipe Menu

Menu	Effect
 FADER — WHITE	Fade in or out with a white screen.
 FADER — BLACK	Fade in or out with a black screen.
 FADER — B.W	Fade in to a colour screen from a black and white screen, or fade out from colour to black and white.
 WIPE — CORNER	Wipe in on a black screen from the upper right to the lower left corner, or wipe out from lower left to upper right, leaving a black screen.
 WIPE — WINDOW	The scene starts in the centre of a black screen and wipes in toward the corners, or comes in from the corners, gradually wiping out to the centre.
 WIPE — SLIDE	Wipe in from right to left, or wipe out from left to right.
 WIPE — DOOR	Wipe in as the two halves of a black screen open to the left and right, revealing the scene, or wipe out and the black screen reappears from left and right to cover the scene.
 WIPE — SCROLL	The scene wipes in from the bottom to the top of a black screen, or wipes out from top to bottom, leaving a black screen.
 WIPE — SHUTTER	Wipe in from the centre of a black screen toward the top and bottom, or wipe out from the top and bottom toward the centre leaving a black screen.

NOTES:

- During Night-Scope, the following functions or settings cannot be activated and its indicator blinks or goes out:
 - Some modes of "Programme AE With Special Effects" (☞ pg. 38, 39).
 - "GAIN UP" in the CAMERA Menu (☞ pg. 29).
 - "DIS" in the MANUAL Menu (☞ pg. 29).
- During Night-Scope, it may be difficult to bring the camcorder into focus. To prevent this, use of manual focus and/or a tripod is recommended.

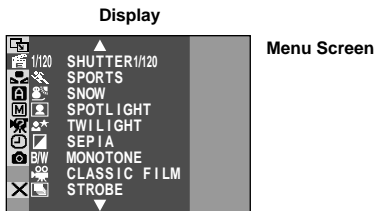
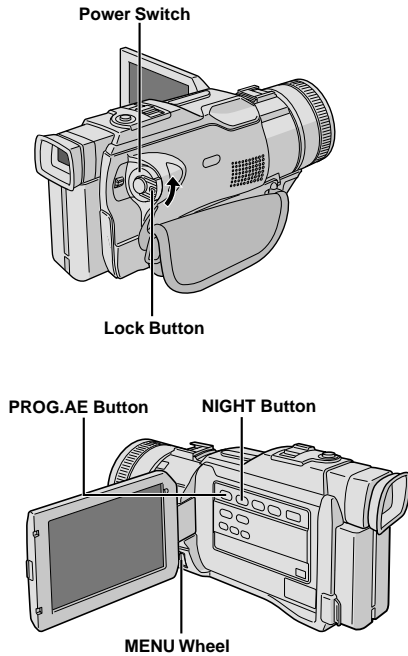
**Night-Scope**

Makes dark subjects or areas even brighter than they would be under good natural lighting. Although the recorded image is not grainy, it may look as if it is strobing due to the slow shutter speed.

1 Set the Power Switch to "M" while pressing down the Lock Button located on the switch. Pull out the viewfinder fully or open the LCD monitor fully.

2 Press **NIGHT** so that the Night-Scope indicator "NS" appears.

- The shutter speed is automatically adjusted to provide up to 30 times sensitivity.
- "A" appears beside "NS" while the shutter speed is being automatically adjusted.

To Deactivate Night-Scope . . .

..... press **NIGHT** again so that the Night-Scope indicator disappears.

Programme AE With Special Effects

1 Set the Power Switch to "M" while pressing down the Lock Button located on the switch. Pull out the viewfinder fully or open the LCD monitor fully.

2 Press **MENU** wheel in. The Menu Screen appears.

3 Rotate the **MENU** wheel to select "PROGRAM AE", then press it.

4 Rotate the **MENU** wheel to select the desired mode (☞ pg. 39), then press it. Selection is complete.

5 Press the **MENU** wheel in again. The Menu Screen closes.

6 Press **PROG.AE** so that the selected effect indicator appears.

To Deactivate The Selected Mode . . .

..... press **PROG.AE** again so that the effect indicator disappears.

NOTES:

- Programme AE with special effects can be changed during recording or during Record-Standby.
- Some modes of Programme AE special effects cannot be used during Night-Scope.

IMPORTANT

Some modes of Programme AE with special effects cannot be used with certain Fade/Wipe Effects (☞ pg. 37). If an unusable mode is selected, its indicator blinks or goes out.

SHUTTER

1/50 –The shutter speed is fixed at 1/50th of a second. Black bands that usually appear when shooting a TV screen become narrower.

1/120 –The shutter speed is fixed at 1/120th of a second. The flickering that occurs when shooting under a fluorescent light or mercury-vapour lamp is reduced.



 **SPORTS**
(Variable
Shutter Speed:
1/250 – 1/4000)*¹

This setting allows fast-moving images to be captured one frame at a time, for vivid, stable slow-motion playback. The faster the shutter speed, the darker the picture becomes. Use the shutter function under good lighting conditions.

**SNOW**

Compensates for subjects that may otherwise appear too dark when shooting in extremely bright surroundings such as in the snow.

**SPOTLIGHT**

Compensates for subjects that may otherwise appear too bright when shooting under extremely strong direct lighting such as spotlights.

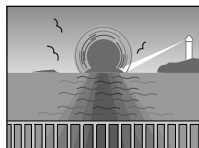

 **TWILIGHT**

Makes evening scenes look more natural. White Balance (pg. 41) is initially set to , but can be changed to your desired setting. When Twilight is chosen, the camcorder automatically adjusts the focus from approx. 10 m to infinity. From less than 10 m, adjust the focus manually.

 **SEPIA**

Recorded scenes have a brownish tint like old photos. Combine this with the Cinema mode for a classic look.

B/W MONOTONE

Like black and white films, your footage is shot in B/W. Used together with the Cinema mode, it enhances the “classic film” effect.



 **CLASSIC FILM**^{*2}

Gives recorded scenes a strobe effect.



 **STROBE**^{*2}

Your recording looks like a series of consecutive snapshots.

 **MIRROR**^{*2}

Creates a mirror image on the left half of the screen, juxtaposed to the normal image on the other half.

*¹ With images shot in the 1600 x 1200 mode, the shutter speed is applicable only up to 1/500 (pg. 16).

*² Available when the VIDEO/MEMORY Switch is set to “VIDEO”.

Exposure Control

Manual exposure adjustment is recommended in the following situations:

- When shooting using reverse lighting or when the background is too bright.
- When shooting on a reflective natural background such as at the beach or when skiing.
- When the background is overly dark or the subject light.

1 Set the Power Switch to “**M**” while pressing down the Lock Button located on the switch, then pull out the viewfinder fully or open the LCD monitor fully.

2 Press **EXPOSURE**. The exposure control indicator appear.



3 Rotate the **MENU** wheel towards “▲” to brighten the image, or towards “▼” to darken the image. (maximum ±6)

4 Press the **MENU** wheel in. Exposure adjustment is complete.

To Return To Automatic Exposure Control . . .



..... press **EXPOSURE** or set the Power Switch to “**A**”.

To Brighten The Subject Quickly . . .

..... press **BACKLIGHT**.  is displayed and the subject is brightened. If pressed again,  disappears and the brightness returns to the previous level.

- +3 exposure has the same effect as the **BACKLIGHT** Button.
- Using **BACKLIGHT** may cause the light around the subject to become too bright and the subject to become white.
- Backlight compensations is also available when the Power Switch is set to “**A**”.

NOTE:

Backlight, spotlight ( pg. 39) compensation and “SNOW” ( pg. 39) have no effect when the manual Exposure Control mode is engaged.

Iris Lock

Use this function in the following situations:

- When shooting a moving subject.
- When the distance to the subject changes (so its size in the LCD monitor or the viewfinder changes), such as when the subject is backing away.
- When shooting on a reflective natural background such as at the beach or when skiing.
- When shooting objects under a spotlight.
- When zooming.

When the subject is close, keep the iris locked. Even when the subject moves away from you, the image will not darken or brighten.

Before the following steps, perform steps 1 and 2 of “Exposure Control”.

3 Adjust zoom so that the subject fills the LCD monitor or the viewfinder, then press and hold the **MENU** wheel for over 2 seconds. The exposure control indicator and “**L**” appear. Press the **MENU** wheel in. “**L**” changes to “**L**” and the iris is locked.

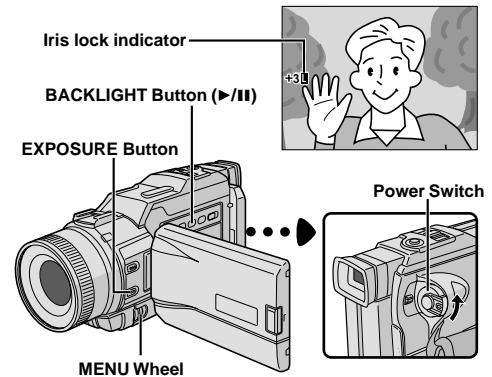

To Return To Automatic Iris Control . . .

..... press **EXPOSURE** so that the exposure control indicator and “**L**” disappear. Or, set the Power Switch to “**A**”.

To Lock The Exposure Control And The Iris . . .

..... after step 2 of “Exposure Control”, adjust the exposure rotating the **MENU** wheel. Then lock the iris in step 3 of “Iris Lock”. For automatic locking, press **EXPOSURE** again in step 2. The iris becomes automatic after about 2 seconds.

Iris

Like the pupil of the human eye, it contracts in well-lit environments to keep too much light from entering, and dilates in dim environments to allow in more light.

White Balance Adjustment

A term that refers to the correctness of colour reproduction under various lighting. If the white balance is correct, all other colours will be accurately reproduced.

The white balance is usually adjusted automatically. However, more advanced camcorder operators control this function manually to achieve a more professional colour/tint reproduction.

1 Set the Power Switch to “**M**” while pressing down the Lock Button located on the switch, then pull out the viewfinder fully or open the LCD monitor fully.

2 Press the **MENU** wheel in. The Menu Screen appears.

3 Rotate the **MENU** wheel to select “**MWB** W.BALANCE”, then press it. The W.BALANCE Menu appears.

4 Rotate the the **MENU** wheel to select the desired mode.

“**AUTO**” White balance is adjusted automatically (factory preset).

“**MWB**” White balance is set manually.

“**FINE**” Outdoors on a sunny day.

“**CLOUD**” Outdoors on a cloudy day.

“**HALOGEN**” ... A video light or similar type of lighting is used.

5 Press the **MENU** wheel in. Selection is complete. Press the **MENU** wheel in again. The Menu Screen closes and the selected mode indicator except “**AUTO**” appears.

To Return To Automatic White Balance . . .

..... select “**AUTO**” in step 4. Or, set the Power Switch to “**A**”.

NOTE:

White balance cannot be used when Sepia or Monotone (pg. 39) is activated.

Manual White Balance Operation

Perform Manual White Balance when shooting under various types of lighting.

1 Follow steps 1 through 4 of the white balance adjustment, and select “**MWB**”.

2 Hold a sheet of plain white paper in front of the subject. Adjust zoom or position yourself so that the white paper fills the screen.

3 Press the **MENU** wheel in until  begins blinking rapidly.

When the setting is completed,  resumes normal blinking.

4 Press the **MENU** wheel in. The Menu Screen closes and the Manual White Balance indicator  is displayed.

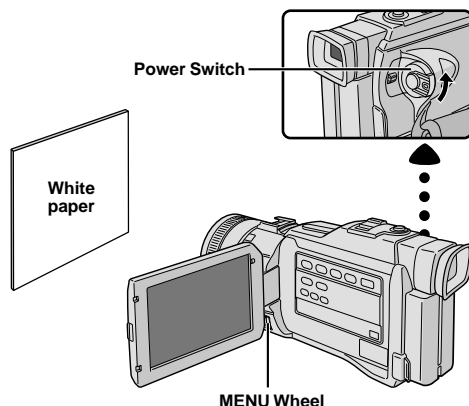

NOTES:

- In step 2, it may be difficult to focus on the white paper. In such a case, adjust focus manually (pg. 24).
- A subject can be shot under various types of lighting conditions indoors (natural, fluorescent, candlelight, etc.). Because the colour temperature is different depending on the light source, the subject tint will differ depending on the white balance settings. Use this function for a more natural result.
- Once you adjust white balance manually, the setting is retained even if the power is turned off or the battery removed.

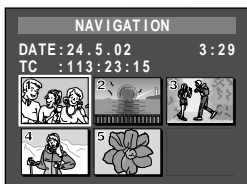
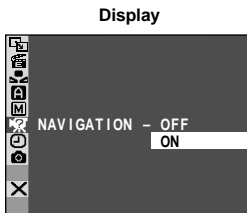
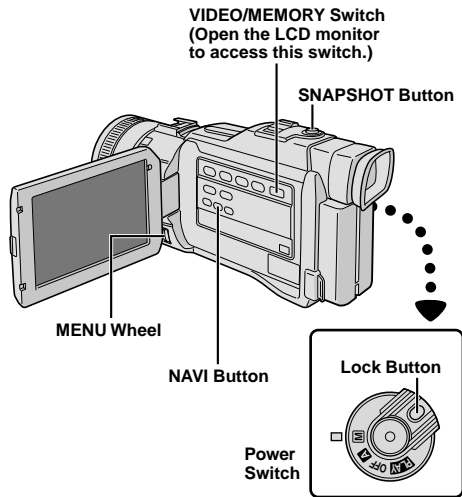

CAUTION

Do not remove the memory card or perform any other operation (such as turning off the camcorder) during deletion. Also, be sure to use the provided AC Power Adapter/Charger, as the memory card may be corrupted if the battery becomes exhausted during deletion. If the memory card becomes corrupted, initialise it. (pg. 51)

NAVIGATION Function

The NAVIGATION Function helps you check tape contents by making thumbnail images on a memory card.

TO MAKE THUMBNAIL IMAGES DURING TAPE RECORDING

- 1 Load a memory card (pg. 13) and cassette (pg. 12). Set the VIDEO/MEMORY Switch to "VIDEO", then set the Power Switch to "M" while pressing down the Lock Button.
- 2 Press the MENU wheel in. The Menu Screen appears. Rotate the MENU wheel to select "SYSTEM" and press it.
- 3 Rotate the MENU wheel to select "NAVIGATION" and press it. The Sub Menu appears. Select "ON" by rotating the MENU wheel and press it.
- 4 Rotate the MENU wheel to select "RETURN" and press it twice. The Menu Screen closes.
 - "||| |||" appears blinking on the screen. Wait until it stops blinking. If it does not stop blinking after a while, check if a memory card is loaded.
- 5 Press the Recording Start/Stop Button to start tape recording.
 - The image of the point where recording is started is captured.
 - If the Recording Start/Stop button is pressed before "||| |||" stops blinking, the image of the point where the loaded memory card is recognized is captured.
 - If the recording time is over 1 minute, " " appears and the captured image is stored on the memory card as a thumbnail image.
- 6 Press the Recording Start/Stop Button to stop tape recording.

NOTE:

The remaining number of storable thumbnail images also appears on the screen when it reaches 10 or less. If "REC SELECT" is set to "G/M" in the Menu Screen, the number shows how many 640 x 480 pixel images can be stored.

TO FIND SCENES ON TAPE USING THUMBNAIL IMAGES (NAVIGATION SEARCH)

- 1 Load a memory card (pg. 13) and cassette (pg. 12). Set the VIDEO/MEMORY Switch to "VIDEO", then set the Power Switch to "PLAY" while pressing down the Lock Button.
- 2 Press NAVI. The loaded tape's NAVIGATION thumbnail image screen appears.
 - Press ►► to display the next page, or press ◀◀ to display the previous page.
- 3 Rotate the MENU wheel to select desired image and press it.
 - "NAVIGATION SEARCH" appears blinking and the camcorder starts searching the tape for the relevant point of the selected thumbnail image.

To cancel NAVIGATION Search midway ...

..... press ►/II, ►►, ◀◀ or ■.

IMPORTANT

- Be sure to always use the same tape and memory card together as they were during recording; otherwise, the camcorder cannot recognize Tape and Memory Card IDs to perform NAVIGATION function properly.
- Check if an appropriate tape and memory card are loaded when the following messages appear: "NO ID ON TAPE OR CARD", "UNABLE TO USE NAVIGATION", "THIS MEMORY CARD IS NOT COMPATIBLE".
- If you change the memory card while shooting on one tape, two memory cards will share the tape's thumbnail images. We recommend that you use one memory card for one tape.
- NAVIGATION Search does not work if the current position is at a blank portion on the tape. Also, do not leave a blank portion partway through the tape when shooting; otherwise, NAVIGATION function does not work properly.
- Before shooting newly over a recorded tape, be sure to delete all thumbnail images of the previous recording from the relevant memory card.
- If you copy thumbnail images from one memory card to another via a PC, NAVIGATION Search does not work with the copied memory card.

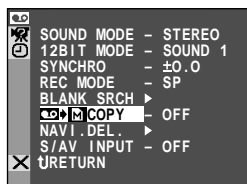
Display**Menu Screen****NAVIGATION Screen**

When "IMAGE SEL." is selected.

TO ADD THUMBNAIL IMAGES DURING TAPE PLAYBACK

- 1 Perform step 1 of "TO FIND SCENES ON TAPE USING THUMBNAIL IMAGES (NAVIGATION SEARCH)".
- 2 Press the **MENU** wheel in. The Menu Screen appears. Rotate the **MENU** wheel to select "**VIDEO**" and press it.
- 3 Rotate the **MENU** wheel to select "**VIDEO** → **M COPY**" and press it. The Sub Menu appears. Select "NAVIGATION" by rotating the **MENU** wheel and press it.
- 4 Rotate the **MENU** wheel to select "**RETURN**" and press it twice. The Menu Screen closes.
- 5 Press **▶/II** to start tape playback.
- 6 Press **SNAPSHOT** at the desired point.
 - "**□**" appears and the image of the point where **SNAPSHOT** is pressed is stored on the memory card as a thumbnail image.

TO DELETE THUMBNAIL IMAGES

- 1 Load a memory card (see pg. 13). Set the **VIDEO/MEMORY** Switch to "VIDEO", then set the Power Switch to "**PLAY**" while pressing down the Lock Button.
- 2 Press the **MENU** wheel in. The Menu Screen appears. Rotate the **MENU** wheel to select "**VIDEO**" and press it. Rotate the **MENU** wheel to select "NAVI.DEL." and press it. The Sub Menu appears.
- 3 By rotating the **MENU** wheel . . .
 - select "IMAGE SEL." to delete the currently displayed thumbnail image.
 - select "TAPE SEL." to delete all thumbnail images for the tape which contains the currently displayed image.
 - select "ALL." to delete all thumbnail images stored on the memory card at once.
 Then, press the **MENU** wheel in. The NAVIGATION screen appears.
- 4 Rotate the **MENU** wheel to select "EXECUTE", then press it.
 - To cancel deletion, select "RETURN". Press **▶▶** to display the next image, or **◀◀** to display the previous image.
 - Thumbnail images cannot be deleted during tape playback.

NOTE:

Once images are deleted, they cannot be restored. Check images before deleting.

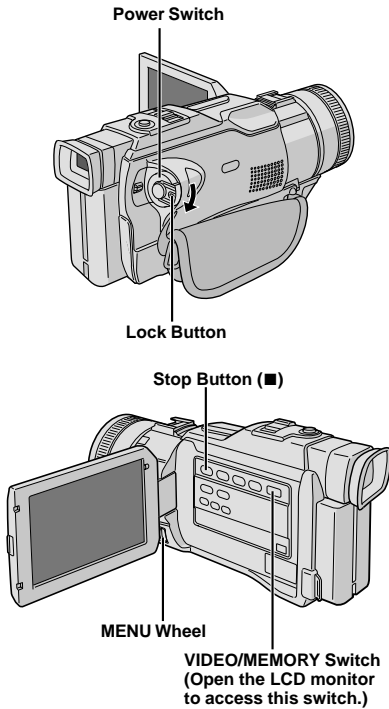

Display



Blank Search

Helps you find where you should start recording in the middle of a tape to avoid time code interruption (▶ pg. 23).

1 Load a tape (▶ pg. 12). Set the **VIDEO/MEMORY Switch** to "VIDEO" and set the Power Switch to "**PLAY**" while pressing down the Lock Button located on the switch.

2 Press the **MENU** wheel in. The Menu Screen appears.

3 Rotate the **MENU** wheel to select "VIDEO", then press it. The VIDEO menu appears.

4 Rotate the **MENU** wheel to select "BLANK SRCH", then press it. The Sub Menu appears.

5 Rotate the **MENU** wheel to select "EXECUTE", then press it.

- "BLANK SEARCH" appears blinking and the camcorder automatically starts reverse or forward shuttle search, then stops at the spot which is about 3 seconds of tape before the beginning of the detected blank portion.

To cancel Blank Search midway . . .

..... press ■.

NOTES:

- In step 5, if the current position is at a blank portion the camcorder searches in the reverse direction, and if the current position is at a recorded portion the camcorder searches in the forward direction.
- Blank Search does not work if "HEAD CLEANING REQUIRED. USE CLEANING CASSETTE" has appeared with the tape.
- If the beginning or end of the tape is reached during Blank Search, the camcorder stops automatically.
- A blank portion which is shorter than 5 seconds of tape cannot be detected.
- The detected blank portion may be located between recorded scenes. Before you start recording, make sure there is no recorded scene after the blank portion.

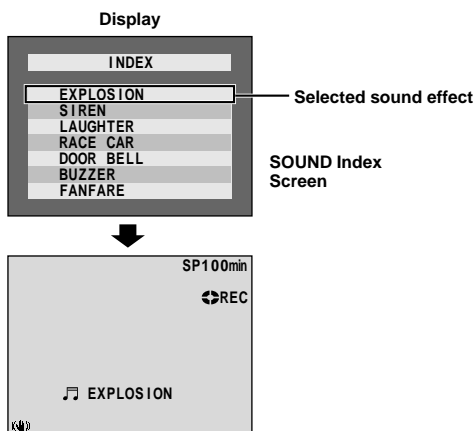
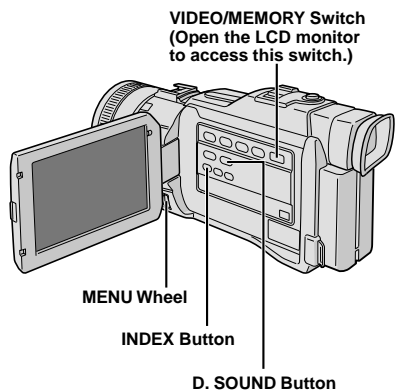

You can download sound data available at our Web Site (see below for URL) and transfer them from your PC to the memory card to create more sound effects.

<http://www.jvc-victor.co.jp/english/download/d-sound/index.html>

- Use the PC Card Adapter CU-VPD60U, Floppy Disk Adapter CU-VFSD50U or USB Reader/Writer CU-VUSD70U to transfer sound data from a PC to the memory card.
- Sound data should be copied into the memory card's DCSD¥100JVCGR folder.
- The file names should be in numerical sequence starting from DVC00001.mp3. If you are using the provided memory card, file names should be from DVC00013.mp3 since 12 sound effects are pre-stored as DVC00001.mp3 through DVC00012.mp3.

Digital Sound Effects

12 sound effects (EXPLOSION, SIREN, LAUGHTER, RACE CAR, DOOR BELL, BUZZER, FANFARE, APPLAUSE, CHEERS, BOING, SCREAM and JEERS) pre-stored on the provided memory card can be dubbed onto a tape.

SOUND EFFECT MODE SELECTION

- 1 Load the provided memory card (☞ pg. 13) and a cassette (☞ pg. 12).
- 2 Set the **VIDEO/MEMORY** Switch to "VIDEO", then set the Power Switch to "A" or "M" while pressing down the Lock Button located on the switch.
- 3 Press **INDEX** twice. The SOUND Index Screen appears.
- 4 Rotate the **MENU** wheel to select the desired sound effect.
- 5 Press the **MENU** wheel in. The selection is complete.
 - Pressing **D. SOUND** starts playback of the currently selected sound effect so you can check it without recording it onto the tape. Press **D. SOUND** again to stop the sound effect playback.

SOUND EFFECT RECORDING

- 6 Press **D. SOUND** during recording. The selected sound effect indication with a "♪" mark appears blinking and the sound effect is recorded onto the tape.
 - The sound effect cannot be heard from the speaker during recording. Use a headphone set to hear the sound effect.

To cancel recording the sound effect midway . . .
 press **D. SOUND** again. The camcorder stops recording the sound effect and the sound effect indication disappears.

NOTES:

- You can delete unwanted sound effects (☞ pg. 50, "Deleting Files") or protect important ones from accidental erasure (☞ pg. 49, "Protecting Files").
- Sound effects can also be used for Audio Dubbing (☞ pg. 73).
- Sound effects created on a PC can be transferred to a memory card by copying them into the memory card's sound folder with the specified file name. For details, refer to the instruction manual of the provided software.

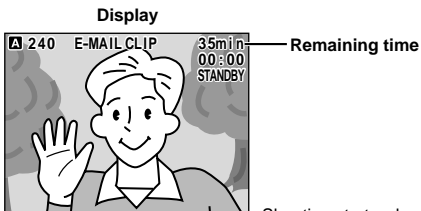
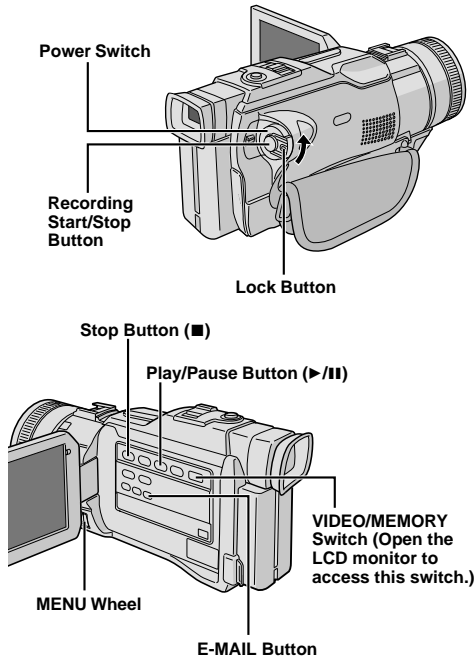

Shooting starts when the Recording Start/Stop Button is pressed



Shooting stops when the Recording Start/Stop Button is pressed again



Recording is complete

E-Mail Clip Recording

You can make video clips from real-time camera image or recorded video footage and store them in a memory card as files which can be conveniently sent via e-mail.

TO MAKE VIDEO CLIPS FROM REAL-TIME CAMERA IMAGE

- 1 Load a memory card (see pg. 13). Set the **VIDEO/MEMORY** Switch to "MEMORY", then set the Power Switch to "M" while pressing down the Lock button located on the switch.
- 2 Press the **MENU** wheel in. The Menu Screen appears. Rotate the **MENU** wheel to select "E-CLIP SYSTEM", then press it.
- 3 Rotate the **MENU** wheel to select "E-CLIP REC", then press it. Rotate the **MENU** wheel to select the desired image size, then press it.
- 4 Rotate the **MENU** wheel to select "RETURN" and press it twice. The Menu Screen closes.
- 5 Press **E-MAIL**. The camcorder enters the E-Mail Clip Record-Standby mode.
- 6 Press the Recording Start/Stop Button to start shooting.
- 7 Press the Recording Start/Stop Button to stop shooting. "COMPLETED" is displayed, then the camcorder re-enters the E-Mail Clip Record-Standby mode.
- 8 Press **E-MAIL** to end E-Mail Clip Recording. The normal screen reappears.

Approximate recording time

SD Memory Card	Image Size	
	240 x 176	160 x 120
32 MB	12 min. 20 sec.	33 min. 20 sec.
16 MB	5 min. 40 sec.	15 min. 40 sec.
8 MB	2 min. 30 sec.	7 min. 00 sec.

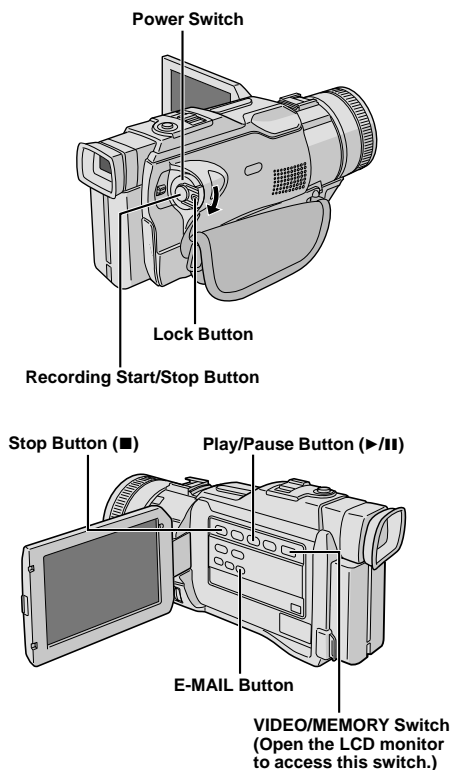

TO MAKE VIDEO CLIPS FROM RECORDED VIDEO FOOTAGE

- 1** Load a memory card (☞ pg. 13) and cassette (☞ pg. 12). Set the **VIDEO/MEMORY Switch** to "VIDEO", then set the Power Switch to "**PLAY**" while pressing down the Lock Button located on the switch.
- 2** Select the image size (☞ pg. 46, steps 2 through 4 of "TO MAKE VIDEO CLIPS FROM REAL-TIME CAMERA IMAGE").
- 3** Press ▶/|| to start tape playback.
- 4** Press **E-MAIL**. "E-MAIL CLIP STANDBY" appears and the camcorder enters the E-Mail Clip Record-Standby mode.
- 5** Press the Recording Start/Stop Button to start E-Mail Clip Recording.
- 6** Press the Recording Start/Stop Button to stop E-Mail Clip Recording. "COMPLETED" is displayed, then the camcorder re-enters the E-Mail Clip Record-Standby mode.
- 7** Press **E-MAIL** to end E-Mail Clip Recording. The normal screen reappears.

To cancel E-Mail Clip Recording . . .

..... after step 4, press **E-MAIL** again or press ■ to stop tape playback.

To view video clips stored on a memory card . . .

..... ☞ pg. 26, 27.

NOTES:

- Playback operation cannot be performed during E-Mail Clip Recording.
- If the end of the tape is reached in step 4, the E-Mail Clip Record-Standby mode will be automatically cancelled.
- The video clip files made with this camcorder are MPEG4 compliant, however, some MPEG4 files made with other devices may not be played back with this camcorder.
- You can delete unwanted video clips (☞ pg. 50, "Deleting Files") or protect important ones from accidental erasure (☞ pg. 49, "Protecting Files").
- TITLE and TITLE Index screen (☞ pg. 48) cannot be used during E-Mail Clip recording.
- Video noise may appear while viewing video clips in the LCD monitor or viewfinder, however, this noise is not present in the actual video clips stored on the memory card.
- You can also view video clips on your PC by using Windows® Media Player. Refer to the instructions of the PC and software.

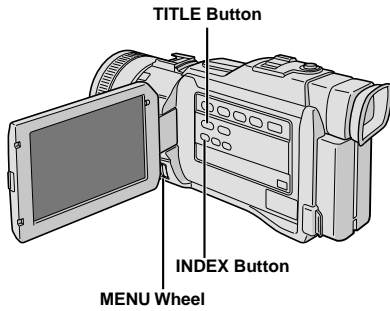

Display

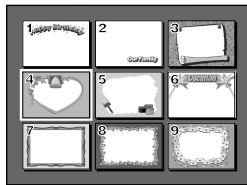

Title Index Screen

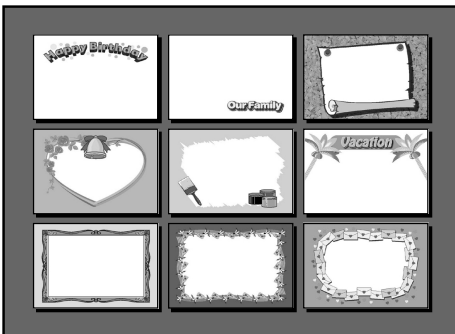
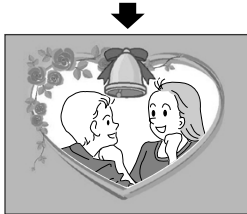

Title Impose

A selection of titles/frames stored on the provided memory card can be superimposed.

TITLE SELECTION

- 1** Load the provided memory card (☞ pg. 13). Set the Power Switch to "M" while pressing down the Lock button located on the switch.
- 2** Press **INDEX** so that the Title Index screen appears.
- 3** Rotate the **MENU** wheel to select the desired title, then press it.
- 4** Press the **MENU** wheel in. The Menu Screen appears. Rotate the **MENU** wheel to select "SYSTEM" and press it.
- 5** Rotate the **MENU** wheel to select "TITLE W/" and press it. The Sub Menu appears. Select the desired mode by rotating the **MENU** wheel and press it.
 - BACKGRND** : Superimposes the title/frame over images.
 - IMAGE** : Superimposes the title/frame with its white background.
- 6** Rotate the **MENU** wheel to select "RETURN" and press it twice. Selection is complete.

TITLE RECORDING

- 7** Press **TITLE** during recording. The selected title/frame is recorded.
 - Press **TITLE** again to turn off the title/frame.

NOTES:

- Title Impose can also be used for dubbing.
- You can delete unwanted titles/frames (☞ pg. 50, "Deleting Files") or protect important ones from accidental erasure (☞ pg. 49, "Protecting Files").
- A title/frame created on a PC can be transferred to a memory card using the provided software. Transferred titles/frames are displayed from Title Index number 10, and they can be used together with the titles/frames on the provided memory card. For details on creating/transferring titles/frames, refer to the software instructions.

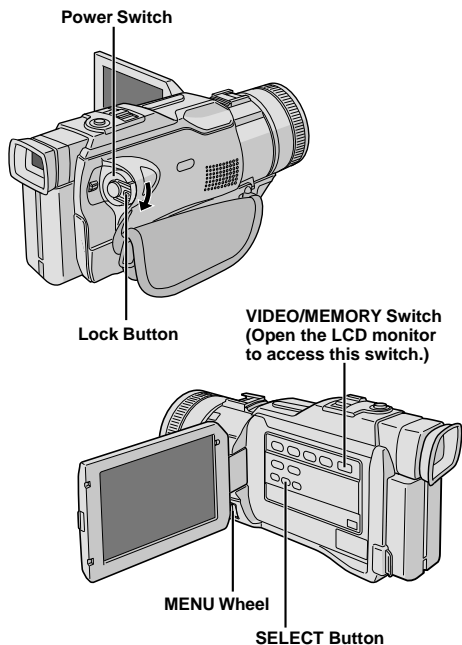

Display

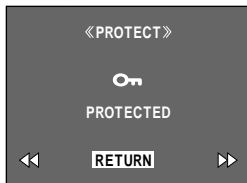
Menu
ScreenPROTECT
Screen

Protecting Files

The Protect mode helps prevent the accidental erasure of files.

- 1 Load a memory card (pg. 13).
- 2 Set the **VIDEO/MEMORY** Switch to “MEMORY”, then set the Power Switch to “**PLAY**” while pressing down the Lock Button located on the switch.
 - A stored file is displayed.

If you want to select another type of file
... go to step 3.

If not ... go to step 4.

- 3 Press **SELECT**. The MEMORY SELECT Screen appears. Rotate the **MENU** wheel to select the type of file: IMAGE, E-MAIL CLIP (pg. 46), SOUND (pg. 45) or TITLE (pg. 48). Then press the **MENU** wheel in. The selected type of file is displayed.

- 4 Press the **MENU** wheel in. The Menu Screen appears. Rotate the **MENU** wheel to select “**PROTECT**”, then press it.

- 5 Rotate the **MENU** wheel to select the desired mode.
 - CURRENT : Protects the currently displayed file.
 - PROT.ALL : Protects all files stored on the memory card.

- 6 Press the **MENU** wheel in. The PROTECT Screen appears.
 - If you selected “CURRENT” in step 5, press ◀◀ or ▶▶ to select the desired file.

- 7 Rotate the **MENU** wheel to select “EXECUTE” and press it.
 - To cancel protection, select “RETURN”.

NOTES:

- If the “**ON**” mark appears, the currently displayed file is protected.
- When the memory is initialised or corrupted, even protected files are deleted. If you do not want to lose important files, transfer them to a PC and save them.

TO REMOVE PROTECTION

Before doing the following, perform steps 1 through 4 above.

- 5 Rotate the **MENU** wheel to select the desired mode.
 - CURRENT : Removes protection from the currently displayed file.
 - CANC.ALL : Removes protection from all files stored on the memory card.

- 6 Press the **MENU** wheel in. The PROTECT Screen appears.
 - If you selected “CURRENT”, press ◀◀ or ▶▶ to select the desired file.

- 7 Rotate the **MENU** wheel to select “EXECUTE” and press it.
 - To cancel selection, select “RETURN”.

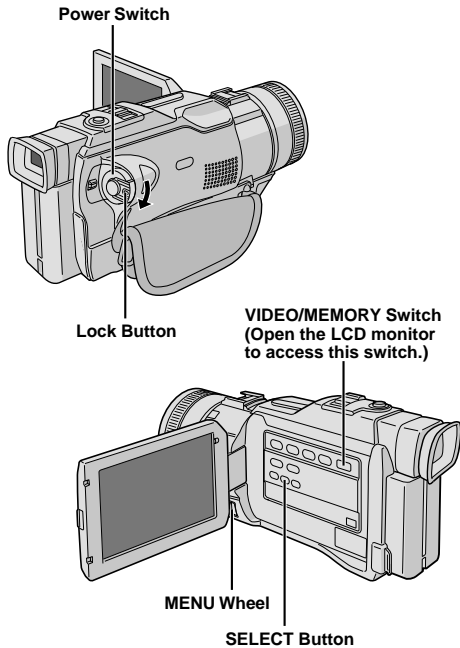

Display



Menu Screen

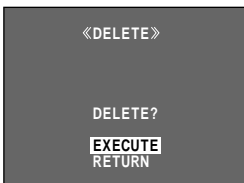

DELETE Screen

CAUTION

Do not remove the memory card or perform any other operation (such as turning off the camcorder) during deletion. Also, be sure to use the provided AC Power Adapter/Charger, as the memory card may be corrupted if the battery becomes exhausted during deletion. If the memory card becomes corrupted, initialise it. (pg. 51)

Deleting Files

Previously stored files can be deleted either one at a time or all at once.

- 1 Load a memory card (pg. 13).
- 2 Set the VIDEO/MEMORY Switch to "MEMORY", then set the Power Switch to "PLAY" while pressing down the Lock Button located on the switch.
 - A stored file is displayed.

If you want to select another type of file
... go to step 3.

If not ... go to step 4.

- 3 Press SELECT. The MEMORY SELECT Screen appears. Rotate the MENU wheel to select the type of file: IMAGE, E-MAIL CLIP (pg. 46), SOUND (pg. 45) or TITLE (pg. 48). Then press the MENU wheel in. The selected type of file is displayed.

- 4 Press the MENU wheel in. The Menu Screen appears. Rotate the MENU wheel to select "DELETE", then press it.

- 5 Rotate the MENU wheel to select the desired mode.

CURRENT : Deletes the currently displayed file.

ALL : Deletes all files stored on the memory card.

- 6 Press the MENU wheel in. The DELETE Screen appears.

- If you selected "CURRENT" in step 5, press ◀ or ▶ to select the desired file.

- 7 Rotate the MENU wheel to select "EXECUTE" and press it.

- If the "On" mark appears, the selected file is protected and cannot be deleted (pg. 49).
- To cancel deletion, select "RETURN".

NOTES:

- Protected files (pg. 49) cannot be deleted with the above operation. To delete them, remove protection first.
- Once files are deleted, they cannot be restored. Check files before deleting.

Folder and File names

Each time shooting takes place, a file name is made using a number which is larger by one than the largest number of the file names which are in use. Even if you delete an IMAGE file with a number in the middle of range, the number will not be used for a new shot; a gap will remain in the numerical sequence. If the file name reaches DVC09999, a new folder (such as "101JVCGR") will be made and the file name will start again from DVC00001.

Making A New Folder

New still pictures you are going to take can be separated from previously shot pictures by resetting the file name to DVC00001; these new pictures will be stored in a new folder.

- 1 Set the **VIDEO/MEMORY** Switch to "MEMORY", then set the Power Switch to "**PLAY**" while pressing down the Lock Button located on the switch.
 - A stored file is displayed.
- 2 Make sure an IMAGE file is displayed (pg. 26); if not, press **SELECT** to access the MEMORY SELECT Screen. Rotate the **MENU** wheel to select "IMAGE", then press it.
- 3 Press the **MENU** wheel in. The Menu Screen appears. Rotate the **MENU** wheel to select "NO. RESET", then press it. The NO. RESET Screen appears.
- 4 Rotate the **MENU** wheel to select "EXECUTE", then press it. The new folder (such as "101JVCGR") will be made and the file name of the next shot starts from DVC00001.

Initialising A Memory Card

You can initialise a memory card anytime. **After initialising, all files and data stored on the memory card, including those which have been protected, are cleared.**

- 1 Perform step 1 of "Making A New Folder" above.
- 2 Press the **MENU** wheel in. The Menu Screen appears. Rotate the **MENU** wheel to select "FORMAT" and press it. The FORMAT Screen appears.
- 3 Rotate the **MENU** wheel to select "EXECUTE" and press it. The memory card is initialised. When initialisation is finished, "NO IMAGES STORED", "NO E-MAIL CLIP STORED", "NO SOUND FILES" or "NO TITLE FILES" appears.
 - To cancel initialisation, rotate the **MENU** wheel to select "RETURN" and press it.

CAUTION

Do not perform any other operation (such as turning off the camcorder) during initialisation. Also, be sure to use the provided AC Power Adapter/Charger, as the memory card may be corrupted if the battery becomes exhausted during initialisation. If the memory card becomes corrupted initialise it.

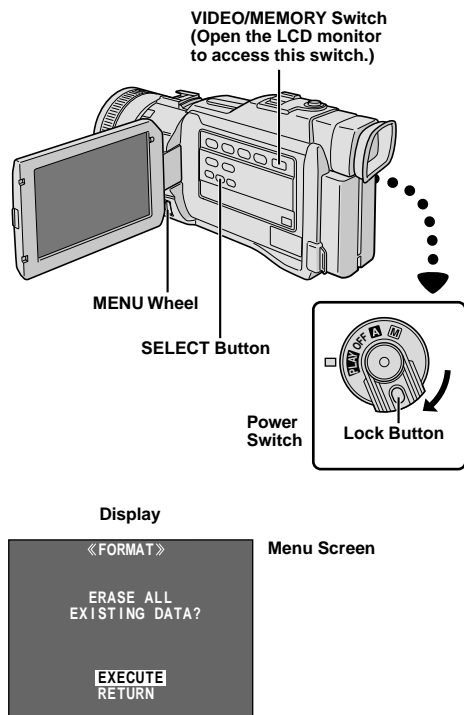

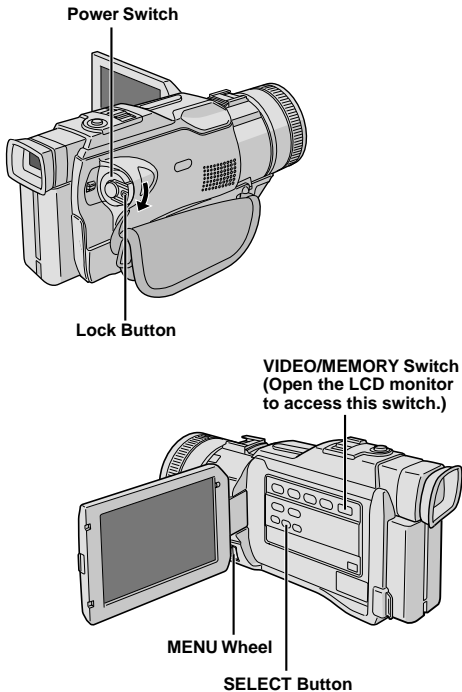

Setting Print Information (DPOF Setting)

This camcorder is compatible with the DPOF (Digital Print Order Format) standard in order to support future systems such as automatic printing, which records information about the still images you wish to print (such as the number of prints to make). There are 2 print information settings available: "To print all still images (one print for each)" explained below and "To print by selecting still images and no. of prints" (pg. 53).

TO PRINT ALL STILL IMAGES (ONE PRINT FOR EACH)

- 1** Set the **VIDEO/MEMORY** switch to "MEMORY", then set the Power Switch to "**PLAY**", while pressing down the Lock Button located on the switch. Open the LCD monitor fully or pull out the viewfinder fully.
 - A stored file is displayed.
- 2** Make sure an **IMAGE** file is displayed (pg. 26); if not, press **SELECT** to access the **MEMORY SELECT** Screen. Rotate the **MENU** wheel to select "IMAGE" and press it.
- 3** Press the **MENU** wheel in. The Menu Screen appears.
- 4** Rotate the **MENU** wheel to select "DPOF" and press it. The Sub Menu appears.
- 5** Rotate the **MENU** wheel to select "ALL 1" and press it. Selection is complete. The DPOF Screen appears.
- 6** Rotate the **MENU** wheel to select "EXECUTE" and press it. The normal playback screen appears.
 - To cancel selection, rotate the **MENU** wheel to select "RETURN" and press it.

To Reset The Setting . . .

..... select "RESET" in step 5. The setting is reset to 0 for all still images.

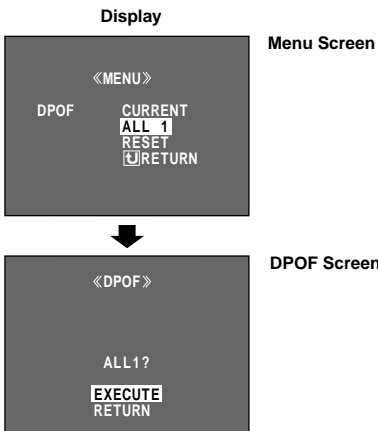

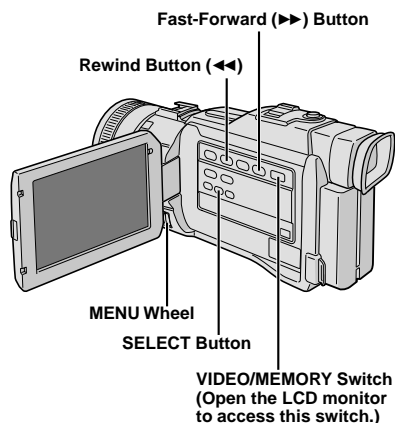

TO PRINT BY SELECTING STILL IMAGES AND NO. OF PRINTS

- 1** Perform steps 1 through 4 on pg. 52.
- 2** Rotate the **MENU** wheel to select "CURRENT" and press it. Selection is complete. The DPOF Screen appears.
- 3** While "«" and "»" are displayed on the screen, press « or » so that the image you wish to print appears.
- 4** Rotate the **MENU** wheel to move the highlight bar to the SHEETS number indication and press it.
- 5** Select the number of prints by rotating the **MENU** wheel and press it.
Repeat steps 3 through 5 for the desired number of prints.
 - The number of prints can be set up to 15.
 - To correct the number of prints, select the image again and change the number.
- 6** Rotate the **MENU** wheel to select "RETURN" and press it. Selection is complete. "SAVE?" appears.
 - If you did not change any settings in step 3 through 5, the Menu Screen reappears.
- 7** Rotate the **MENU** wheel to select "EXECUTE", then press it to save the setting you have just made.
 - To cancel selection, rotate the **MENU** wheel to select "CANCEL" and press it.

To Reset The No. Of Prints . . .

..... select "RESET" in step 5 on pg. 52. The number of prints is reset to 0 for all still images.

CAUTION

While performing the above, never disconnect power, as this may cause the memory to be corrupted. For safety, all buttons including the Power Switch are disabled in step 6.

NOTES:

- "BATTERY LOW" appears if the battery remaining power is too low.
- If you load a memory card already set as shown above in a printer compatible with DPOF, it will make prints of the selected still images automatically.
- To print images recorded on a tape, first dub them to a memory card (pg. 61).

These are some basic types of connections. When making the connections, refer also to your VCR and TV instruction manuals.

A. Connection to a TV or VCR equipped with an S-VIDEO IN and A/V input connectors

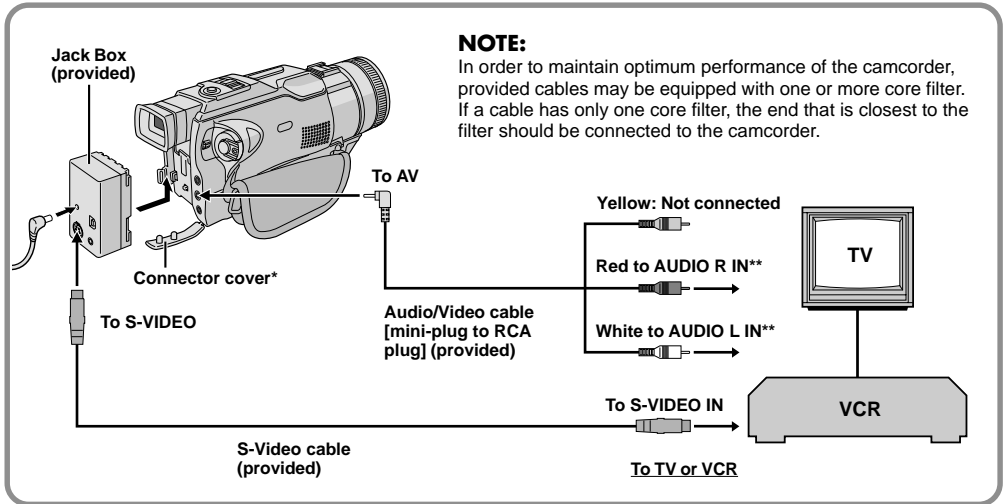

* When connecting the cables, open this cover.

** The Audio cable is not required for watching still images only.

B. Connection to a TV or VCR equipped only with A/V input connectors

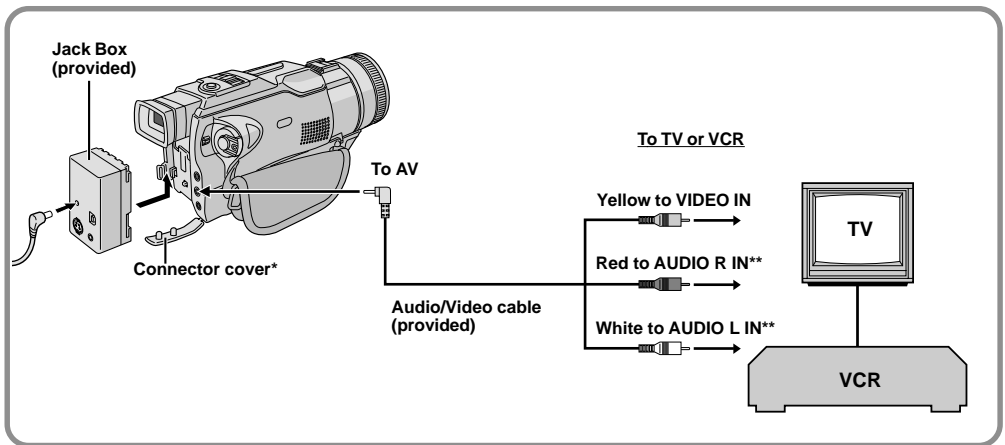

* When connecting the cables, open this cover.

** The Audio cable is not required for watching still images only.

- 1** Make sure all units are turned off.
 - 2** Connect the camcorder to a TV or VCR as shown in the illustration (☞ pg. 54).
- If using a VCR . . . go to step 3.**
If not . . . go to step 4.
- 3** Connect the VCR output to the TV input, referring to your VCR's instruction manual.
 - 4** Turn on the camcorder, the VCR and the TV.
 - 5** Set the VCR to its AUX input mode, and set the TV to its VIDEO mode.

To choose whether or not the following displays appear on the connected TV . . .

- Date/Time
 - set "DATE/TIME" to "AUTO", "ON" or "OFF" in the Menu Screen (☞ pg. 32).
 - Or, press **DISPLAY** on the remote control to turn on/off the date indication.
- Time Code
 - set "TIME CODE" to "ON" or "OFF" in the Menu Screen (☞ pg. 32).
- Playback Sound Mode, Tape Speed And Tape Running Displays for tape playback
 - set "ON SCREEN" to "LCD" or "LCD/TV" in the Menu Screen (☞ pg. 32).

NOTES:

- **It is recommended to use the AC Power Adapter/Charger as the power supply instead of the battery pack (☞ pg. 9).**
- To monitor the picture and sound from the camcorder without inserting a tape or memory card, set the camcorder's Power Switch to "A" or "M", then set your TV to the appropriate input mode.
- Make sure you adjust the TV sound volume to its minimum level to avoid a sudden burst of sound when the camcorder is turned on.
- If you have a TV or speakers that are not specially shielded, do not place the speakers adjacent to the TV as interference will occur in the camcorder playback picture.
- If no image is displayed or no sound is heard from the TV, set "S/AV INPUT" to "OFF" in the Menu Screen (☞ pg. 32).
- When a cable is connected to the AV or PHONE connector, the sound is not heard from the speaker.

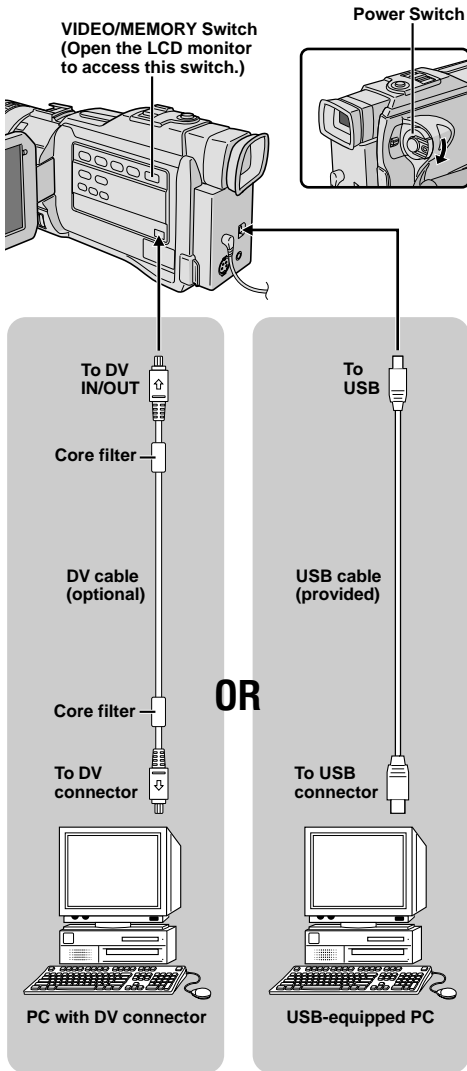

Connection To A Personal Computer

This camcorder can transfer still images to a PC via DV or USB connection as shown in the illustration.

- 1** Make sure the camcorder and PC are turned off.
- 2** Connect the camcorder to your PC using the appropriate cable as shown in the illustration.
- 3** If you are using the USB connection, set the VIDEO/MEMORY switch to "MEMORY".

- 4** Turn the camcorder's Power Switch to "**PLAY**" while pressing down the Lock Button located on the switch and turn on the PC.

- Refer to the instruction manual of the software on how to transfer a still image to the PC.
- If the PC connected to the camcorder via the USB cable is not powered on, the camcorder does not enter the USB mode.

- 5** When finished, turn off the PC first, then the camcorder.

NOTES:

- In order to maintain optimum performance of the camcorder, provided cables may be equipped with one or more core filter. If a cable has only one core filter, the end that is closest to the filter should be connected to the camcorder.
- **It is recommended to use the AC Power Adapter/Charger as the power supply instead of the battery pack** (▶ pg. 9).
- **Never connect the USB cable and the DV cable simultaneously to the camcorder. Connect only the cable you wish to use to the camcorder.**
- The date/time information cannot be captured into the PC.
- Refer to the instruction manuals of the PC and provided Software.
- The still images can also be transferred to a PC with a DV connector-equipped capture board.
- **When using a DV cable, be sure to use the optional JVC VC-VDV206U or VC-VDV204U DV cable depending on the type of DV connector (4 or 6 pins) on the PC, or use the DV cable provided with the capture board.**
- The system may not work properly depending on the PC or capture board you are using.

"ACCESSING FILES" appears on the LCD monitor while the PC is accessing data in the camcorder or the camcorder is transferring a file to the PC. **Never disconnect the USB cable while "ACCESSING FILES" is displayed on the LCD monitor since this can result in product damage.**

Using The Camcorder As A WebCam

This camcorder can be used as a WebCam via USB connection.

- 1** Make sure all necessary software (provided) are installed in your PC and all units are turned off.
- 2** Connect the camcorder to your PC using the USB cable.
- 3** Set the **VIDEO/MEMORY** Switch to "MEMORY" and set the Power Switch to "**A**" or "**M**", then turn on the PC.
 - "Web CAMERA" appears on the screen.
 - If the PC is not powered on, the camcorder does not enter the Web Camera mode.
- 4** When finished, turn off the PC first, then the camcorder. Disconnect the USB cable from the camcorder and PC.

NOTES:

- In order to maintain optimum performance of the camcorder, provided cables may be equipped with one or more core filter. If a cable has only one core filter, the end that is closest to the filter should be connected to the camcorder.
- **It is recommended to use the AC Power Adapter/Charger as the power supply instead of the battery pack (pg. 9).**
- Use the provided software PIXELA ImageMixer to capture video in real-time.
- You can also use the camcorder for webconference by using Windows® Microsoft Netmeeting and signing up for Microsoft Hotmail.
- In the Web Camera mode, the following buttons cannot be operated: **TITLE**, **E-MAIL**, **SNAPSHOT**, the Recording Start/Stop button.

Refer to the instruction manuals of the PC and provided Software.

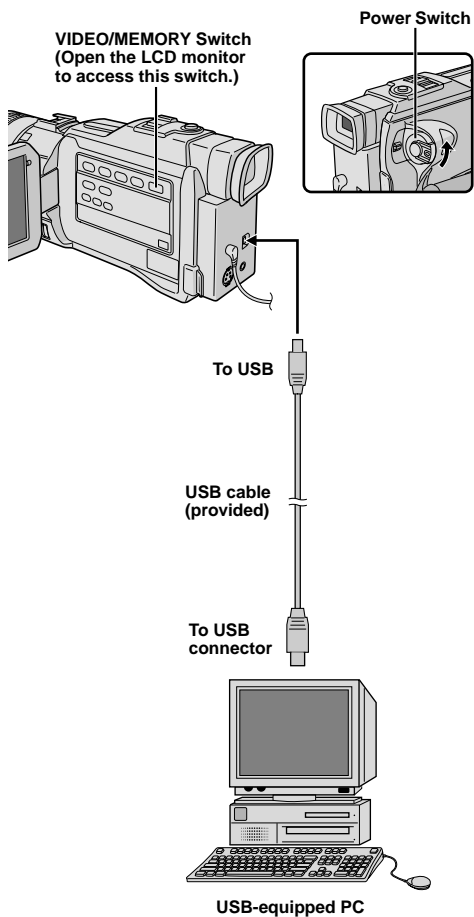

Display

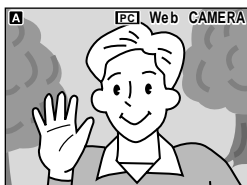

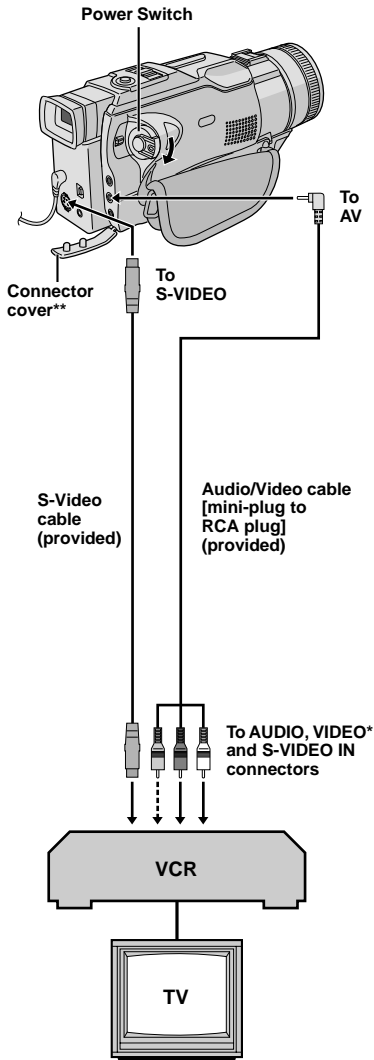

Dubbing To A VCR

[To use this camcorder as a player]

- 1** Following the illustration, connect the camcorder and the VCR. Also refer to pg. 54 and 55.
- 2** Set the **VIDEO/MEMORY** Switch to "VIDEO", then set the camcorder's Power Switch to "**PLAY**" while pressing down the Lock Button located on the switch, turn on the VCR's power, and insert the appropriate cassettes in the camcorder and the VCR.
- 3** Set "S/AV INPUT" to "OFF" in the Menu Screen (☞ pg. 32).
- 4** Engage the VCR's AUX and Record-Pause modes.
- 5** Engage the camcorder's Play mode to find a spot just before the edit-in point. Once it is reached, press ►/II on the camcorder.
- 6** Press ►/II on the camcorder and engage the VCR's Record mode.
- 7** Engage the VCR's Record-Pause mode and press ►/II on the camcorder.
- 8** Repeat steps 5 through 7 for additional editing, then stop the VCR and camcorder when finished.

NOTES:

- As the camcorder starts to play your footage it will appear on your TV. This will confirm the connections and the AUX channel for dubbing purposes.
- You can use Title Impose (☞ pg. 48), Playback Zoom (☞ pg. 64) or Playback Special Effects (☞ pg. 65) in step 6.
- Before you start dubbing, make sure that the indications do not appear on the connected TV. If they do, they are being recorded onto the new tape.

To choose whether or not the following displays appear on the connected TV . . .

- Date/Time
..... set "DATE/TIME" to "AUTO", "ON" or "OFF" in the Menu Screen (☞ pg. 32).
Or, press **DISPLAY** on the remote control to turn on/off the date indication.
- Time Code
..... set "TIME CODE" to "ON" or "OFF" in the Menu Screen (☞ pg. 32).
- Playback Sound Mode, Tape Speed And Tape Running Displays
..... set "ON SCREEN" to "LCD" or "LCD/TV" in the Menu Screen (☞ pg. 32).
- In order to maintain optimum performance of the camcorder, provided cables may be equipped with one or more core filter. If a cable has only one core filter, the end that is closest to the filter should be connected to the camcorder.

* Connect when an S-Video cable is not used.

** When connecting the cables, open this cover.

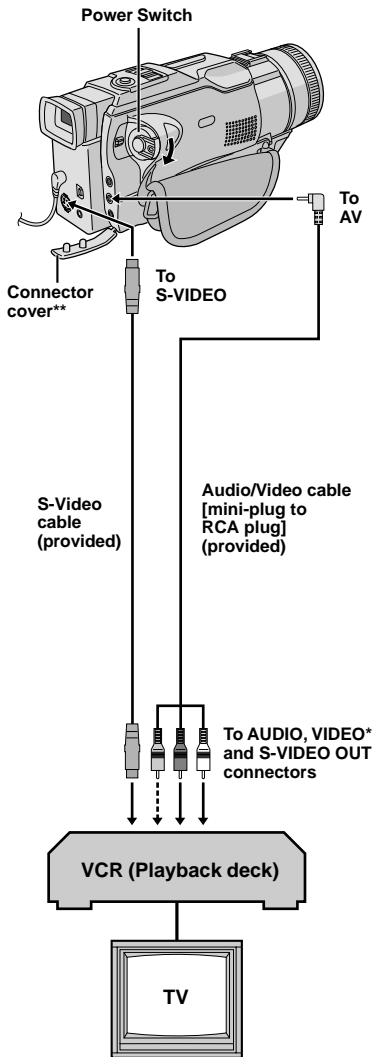

Dubbing From A VCR

[To Use This Camcorder As A Recorder]

- 1** Make sure all units are turned off, then connect the camcorder and the VCR as shown in the illustration. Also refer to pg. 54 and 55.
- 2** Set "SOUND MODE" to "12 BIT" or "16 BIT" and "REC MODE" to "SP" or "LP" in the Menu Screen depending on your preference (☞ pg. 32).
- 3** Set the camcorder's Power Switch to "PLAY" while pressing down the Lock Button located on the switch. Turn on the VCR's power and insert the appropriate cassettes in the camcorder and the VCR.
- 4** Set "S/AV INPUT" to "ON" in the Menu Screen to engage the analogue input mode (☞ pg. 32).
- 5** Press the Recording Start/Stop Button on the camcorder to engage the Record-Pause mode. "AV.IN" appears on the screen.
- 6** Engage the VCR's Play mode, then engage the Still Playback mode when you have found a spot just before the edit-in point.
- 7** Press the Recording Start/Stop Button on the camcorder to engage the Record mode. ⏪ rotates on the screen. Engage the VCR's Play mode.
- 8** To stop dubbing, press the Recording Start/Stop Button on the camcorder so that ⏪ stops rotating, then engage the VCR's Stop mode.
- 9** Repeat steps 6 through 8 for additional editing.
- 10** Set "S/AV INPUT" back to "OFF" in the Menu Screen to disengage the analogue input mode (☞ pg. 32).

NOTES:

- It is recommended to use the AC Power Adapter/Charger as the power supply instead of the battery pack (☞ pg. 9).
- Analogue signals can be converted to digital signals with this procedure.
- It is also possible to dub from another camcorder.

* Connect when an S-Video cable is not used.

** When connecting the cables, open this cover.

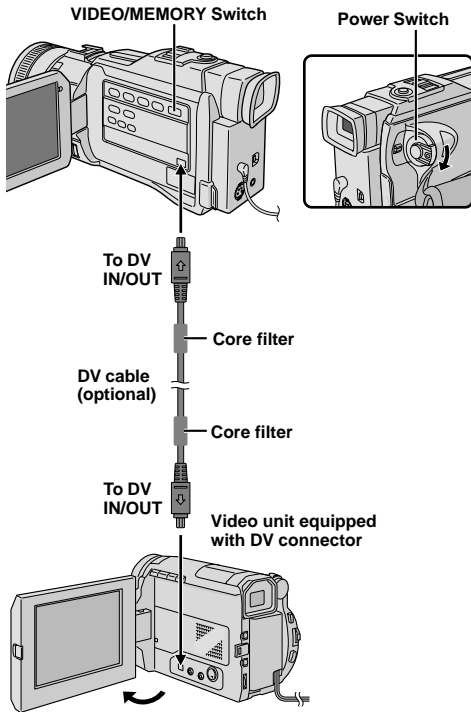

Dubbing To Or From A Video Unit Equipped With A DV Connector (Digital Dubbing)

It is also possible to copy recorded scenes from this camcorder onto another video unit equipped with a DV connector. Since a digital signal is sent, there is little if any image or sound deterioration.

[To use this camcorder as a player]

- 1** Make sure all units are turned off. Connect this camcorder to a video unit equipped with a DV input connector using a DV cable as shown in the illustration.
- 2** Set this camcorder's **VIDEO/MEMORY** Switch to "VIDEO", then the Power Switch to "**PLAY**" while pressing down the Lock Button located on the switch, turn on the video unit's power, and insert the appropriate cassettes in this camcorder and the video unit.
- 3** Press **▶** to play back the source tape.
- 4** While watching the playback on the monitor, engage the DV connector-equipped video unit's record mode from the spot on the source tape you want to begin recording.

NOTES:

- It is recommended to use the AC Power Adapter/Charger as the power supply instead of the battery pack (☞ pg. 9).
- If the remote control is used when both the player and recorder are JVC video units, both units will perform the same operation. To prevent this from happening, press the buttons on both units.
- If a blank portion or disturbed image is played back on the player during dubbing, the dubbing may stop so that an unusual image is not dubbed.
- Even though the DV cable is connected correctly, sometimes the image may not appear in step 4. If this occurs, turn off the power and make connections again.
- If "Title Impose" (☞ pg. 48), "Playback Zoom" (☞ pg. 64), "Playback Special Effects" (☞ pg. 65) or "Snapshot" is attempted during playback, only the original playback image recorded on the tape is output from the DV IN/OUT connector.
- When using a DV cable, be sure to use the optional JVC VC-VDV204U DV cable.

[To Use This Camcorder As A Recorder]

1. Set this camcorder's **VIDEO/MEMORY** Switch to "VIDEO", then the Power Switch to "**PLAY**" while pressing down the Lock Button located on the switch.
2. Set "REC MODE" to "SP" or "LP" in the Menu Screen (☞ pg. 32).
3. Connect the DV cable as shown in the illustration and load a cassette to record on.
4. Press the Recording Start/Stop button to engage the Record-Pause mode. "**DV.IN**" appears on the screen.
5. Press the Recording Start/Stop button to start recording. **▶** rotates.
6. Press the Recording Start/Stop button again to engage the Record-Pause mode. **▶** stops rotating.

NOTE:

Digital Dubbing is performed in the sound mode recorded on the original tape, regardless of the current "SOUND MODE" setting (☞ pg. 29).

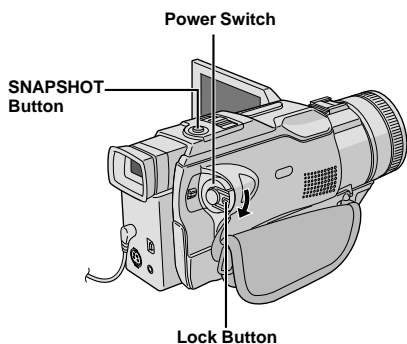

Dubbing Still Images Recorded On A Tape To A Memory Card

Still images can be dubbed from a tape to a memory card.

- 1** Load a memory card (☞ pg. 13) and cassette (☞ pg. 12).
- 2** Set the **VIDEO/MEMORY** Switch to "VIDEO", then set the Power Switch to "PLAY" while pressing down the Lock Button.
- 3** Press the **MENU** wheel in. The Menu Screen appears. Rotate it to select "VIDEO" and press it. The VIDEO Menu appears.
- 4** Rotate the **MENU** wheel to select "VIDEO → M COPY" and press it. The Sub Menu appears. Rotate it to select "IMAGE" and press it. Selection is complete.
- 5** Rotate the **MENU** wheel to select "RETURN" and press it twice. The normal playback screen reappears.
- 6** To select a video image to be dubbed, start playback by pressing ►/II. At the moment you find the image you wish to dub, press it again to engage Still Playback.
- 7** To start dubbing, press **SNAPSHOT**. The selected image is stored on the memory card.
 - "►" blinks during dubbing.

NOTES:

- If **SNAPSHOT** is pressed in step 7 when a memory card is not loaded, the message "COPYING FAILED" is displayed.
- If an image recorded on the tape using the **WIDE** mode (☞ pg. 30) is dubbed to a memory card, the **WIDE** mode identifying signal is not dubbed with it.
- To use Playback Special Effects with a video image you wish to dub, perform up to step 7 using the remote control (provided) (☞ pg. 65).
- Images are dubbed in 640 x 480 pixels.

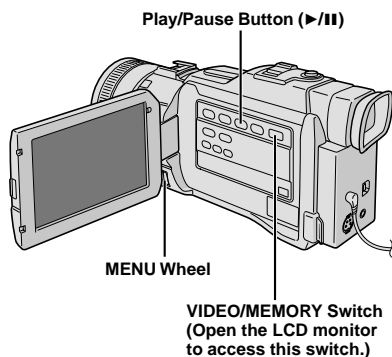
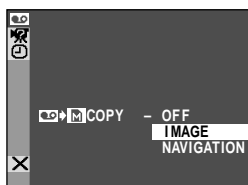

Display

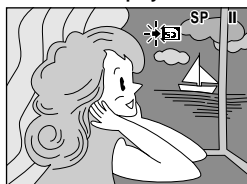

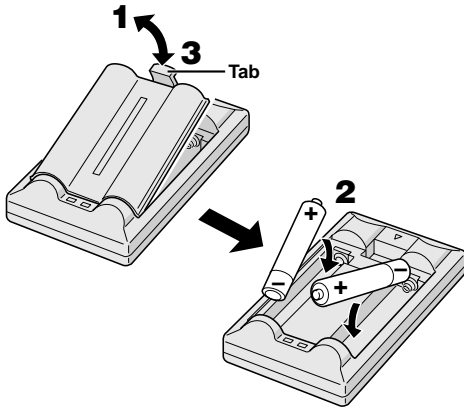

Insert the minus (-) end first.

The Full-Function Remote Control Unit can operate this camcorder from a distance as well as the basic operations (Playback, Stop, Pause, Fast-Forward and Rewind) of your VCR. It also makes additional playback functions possible.

Installing The Batteries

The remote control uses two "AAA (R03)" size batteries. See "General Battery Precautions" (pg. 89).

- 1** Remove the battery compartment cover while pushing up the tab as illustrated.
- 2** Insert two "AAA (R03)" size batteries in the correct direction.
- 3** Re-attach the battery compartment cover.

Infrared beam transmitting window
(pg. 63)

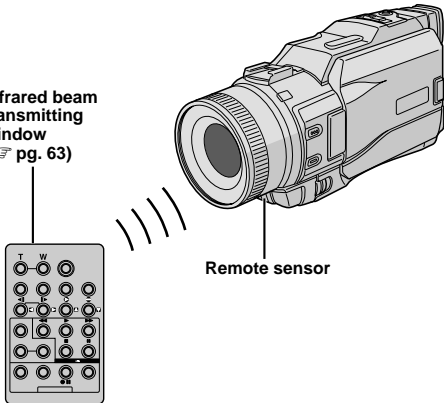

When using the remote control, be sure to point it at the remote sensor. The transmitted beam's approximate effective area for indoor use is 5 m.

The transmitted beam may not be effective or may cause incorrect operation outdoors or when the remote sensor is directly exposed to sunlight or powerful lighting.

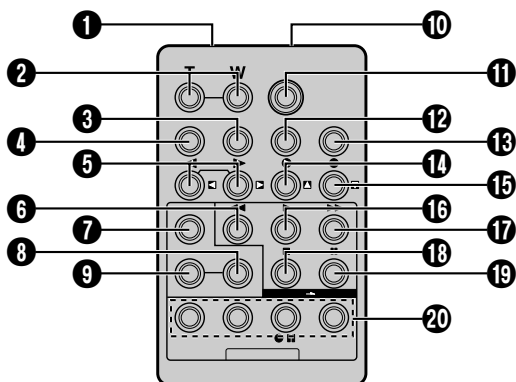

Buttons	Functions	
	With the camcorder's Power Switch set to the camera position ("A" or "M").	With the camcorder's Power Switch set to "PLAY".
① Infrared beam transmitting window	Transmits the beam signal.	
② Zoom (T/W) Buttons	Zoom in/out (☞ pg. 22)	Zoom in/out (☞ pg. 64)
③ DISPLAY Button	—	☞ pg. 67
④ SHIFT Button	—	☞ pg. 64, 66
⑤ SLOW Rewind/Forward Buttons Left/Right Buttons	— —	☞ pg. 64 ☞ pg. 64
⑥ REW Button	—	<ul style="list-style-type: none"> •Rewind/Reverse Shuttle Search on the tape (☞ pg. 25) •Displays previous page/file on the memory card (☞ pg. 26, 27)
⑦ FADE/WIPE Button	—	☞ pg. 68
⑧ EFFECT ON/OFF Button	—	☞ pg. 65
⑨ EFFECT Button	—	☞ pg. 65
⑩ PAUSE IN Connector	—	☞ pg. 67
⑪ START/STOP Button	Functions the same as the Recording Start/Stop Button on the camcorder.	
⑫ MBR SET Button	—	☞ pg. 66
⑬ SNAPSHOT Button	Functions the same as SNAPSHOT on the camcorder.	
⑭ Up Button INSERT Button	— —	☞ pg. 64 ☞ pg. 71
⑮ Down Button A. DUB Button	— —	☞ pg. 64 ☞ pg. 72
⑯ PLAY Button	—	<ul style="list-style-type: none"> •Starts Playback of the tape (☞ pg. 25) •Starts Auto Playback of the memory card (☞ pg. 26)
⑰ FF Button	—	<ul style="list-style-type: none"> •Forward/Forward Shuttle Search on the tape (☞ pg. 25) •Displays next page/file on the memory card (☞ pg. 26, 27)
⑱ STOP Button	—	<ul style="list-style-type: none"> •Stops the tape (☞ pg. 25) •Stops Auto Playback (☞ pg. 26)
⑲ PAUSE Button	—	Pauses the tape (☞ pg. 64)
⑳ R.A.EDIT Buttons	—	☞ pg. 66 – 70

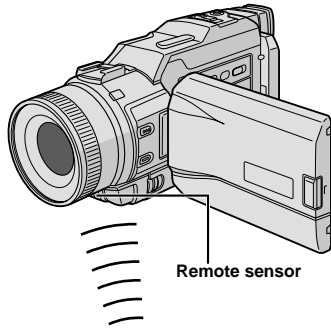

Remote sensor

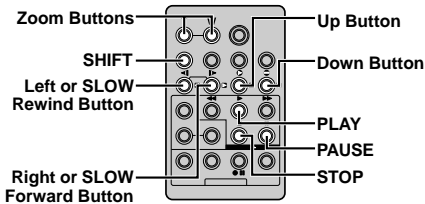

Normal playback

Press T



To move image, press **▶** (Right) while keeping **SHIFT** held down.

FEATURE: Slow-Motion Playback

PURPOSE:

To allow slow-speed search in either direction during tape playback.

OPERATION:

- 1) To change from normal to Slow-Motion Playback, press **SLOW** (**◀** or **▶**) more than approx. 2 seconds. After approx. 5 minutes (approx. 20 seconds with an 80-minute cassette) in Slow Rewind or approx. 5 minutes in Slow Forward, normal playback resumes.
 - To stop Slow-Motion Playback, press **PLAY** (**▶**).

NOTES:

- You can also engage Slow-Motion Playback from Still Playback by pressing **SLOW** more than approx. 2 seconds.
- During Slow-Motion Playback, due to digital image processing, the picture may take on a mosaic effect.
- After **SLOW** (**◀** or **▶**) is pressed and held, the still image may be displayed for a few seconds, followed by a blue screen for a few seconds. This is not a malfunction.
- There may be a small margin between the slow-motion playback start point you chose and the actual start point for Slow-Motion Playback.
- During Slow-Motion Playback, there will be disturbances in video and the picture may seem unstable, especially with steady images. This is not a malfunction.
- During Slow-Motion Playback, press **PAUSE** (**||**) to pause playback.

FEATURE: Frame-By-Frame Playback

PURPOSE:

To allow frame-by-frame search during tape playback.

OPERATION:

- 1) To change from normal to Frame-By-Frame Playback, press **SLOW** (**▶**) repeatedly for forward or **SLOW** (**◀**) repeatedly for reverse. Each time it is pressed, the frame is played back.

NOTE:

You can also engage Frame-By-Frame Playback from Still Playback by pressing **SLOW** (**◀** or **▶**) repeatedly.

FEATURE: Playback Zoom

PURPOSE:

To magnify the recorded image up to 30X at any time during playback.

OPERATION:

- 1) Press **PLAY** (**▶**) to find the scene of interest.
- 2) Press the Zoom Buttons (**T/W**) on the remote control. Make sure the remote control is pointed at the camcorder's remote sensor. Pressing **T** zooms in.
- 3) You can move the image on screen around to find a particular portion of the picture. While holding down **SHIFT**, press **◀** (Left), **▶** (Right), **▲** (Up) and **▼** (Down).
 - To end zoom, press and hold **W** until magnification returns to normal. Or, press **STOP** (**■**) and then press **PLAY** (**▶**).

NOTES:

- Zoom can also be used during slow-motion and still playback.
- Due to digital image processing, the quality of the image may suffer.

PLAYBACK EFFECT

- OFF
- 1 CLASSIC FILM
- 2 MONOTONE
- 3 SEPIA
- 4 STROBE

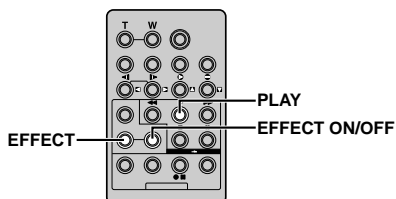
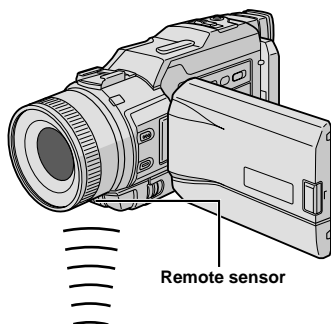
PLAYBACK EFFECT
Select MenuFEATURE: **Playback Special Effects****PURPOSE:**

To allow you to add creative effects to the tape playback image.

OPERATION:

- 1) To start playback, press **PLAY** (▶).
- 2) Point the remote control at the camcorder's remote sensor and press **EFFECT**. The **PLAYBACK EFFECT Select Menu** appears.
- 3) Move the highlight bar to the desired effect by pressing **EFFECT**. The selected function is activated and after 2 seconds the menu disappears.
 - To deactivate the selected effect, press **EFFECT ON/OFF** on the remote control. Pressing it again re-activates the selected effect.
 - To change the selected effect, repeat from step 2 above.

NOTE:

The effects that can be used during playback are Classic Film, Monotone, Sepia and Strobe. The effects work the same in playback as they did in recording. Refer to page 39 for more information.

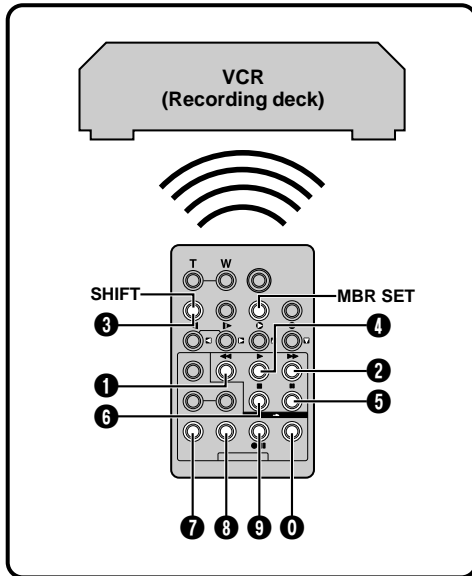

Random Assemble Editing [R.A.Edit]

Create edited videos easily using your camcorder as the source player. You can select up to 8 "cuts" for automatic editing, in any order you like. R.A.Edit is more easily performed when the MBR (Multi-Brand Remote) is set to operate with your brand of VCR (see VCR CODE LIST), but can also be performed by operating the VCR manually.

Before operation, make sure the batteries are installed in the remote control (☞ pg. 62).

SET REMOTE/VCR CODE

1 Turn off the power to the VCR and point the remote towards the VCR's infrared sensor. Then, referring to the VCR CODE LIST, press and hold **MBR SET**, and enter the brand code. The code is automatically set once you release **MBR SET**, and the VCR's power comes on.

2 Make sure the VCR's power is on. Then, while holding **SHIFT**, press the button on the remote for the desired function. The functions the remote can control are PLAY, STOP, PAUSE, FF, REW and VCR REC STBY (you do not need to press **SHIFT** for this one).

You are now ready to try Random Assemble Editing.

VCR CODE LIST

VCR BRAND NAME	BRAND CODE	VCR BRAND NAME	BRAND CODE
AKAI	6 2	PHILIPS	1 9
	6 4		9 5
	7 7		1 1
BLAUPUNKT	1 3		9 4
			9 1
DAEWOO	1 8		9 6
FERGUSON	9 7		1 2
	9 8		3 3
	3 2		7 2
GRUNDIG	1 4		SAMSUNG
	3 4	SANYO	3 6
HITACHI	6 6		3 5
	6 3	SELECO, REX	9 1
JVC A B C	9 1		9 6
	9 6	SHARP	1 5
	9 3		1 0
LG/GOLDSTAR	1 1	SONY	6 5
MITSUBISHI	6 7		6 0
	6 8		3 9
NEC	3 7		3 1
	3 8	THOMSON, TELEFUNKEN, SABA, NORDMENDE	9 1
PANASONIC	1 3		9 6
	1 7		9 7
	1 1	TOSHIBA	3 2
	9 4		6 9
	1 8		6 1

IMPORTANT

Although the MBR is compatible with JVC VCRs and those of many other makers, it may not work with yours or may offer limited functions.

NOTES:

- If the VCR's power does not come on in step 1, try another code from the VCR CODE LIST.
- Some brands of VCR do not come on automatically. In this case, turn the power on manually and try step 2.
- If the remote control is not able to control the VCR, use the controls on the VCR.
- When the remote control's batteries run out, the VCR brand you have set will be erased. In that case, replace the old battery with a new one to reset the VCR brand.

MAKE CONNECTIONS

Also refer to pg. 54 and 55.

1 **A** A JVC VCR equipped with a remote pause connector . . .

..... connect the editing cable to the Remote PAUSE connector.

B A JVC VCR not equipped with a remote pause connector but equipped with an R.A.EDIT connector . . .

..... connect the editing cable to the R.A.EDIT connector.

C A VCR other than above . . .

..... connect the editing cable to the remote control's PAUSE IN connector.

2 Insert a recorded tape into the camcorder. Set the VIDEO/MEMORY Switch to "VIDEO", then set the Power Switch to "PLAY" while pressing down the Lock Button located on the switch.

3 Turn the VCR power on, insert a recordable tape and engage the AUX mode (refer to the VCR's instructions).

NOTES:

- Before Random Assemble Editing, make sure the indications do not appear on the TV monitor. If they do, they will be recorded onto the new tape.

To choose whether or not the following displays appear on the connected TV . . .

- Date/Time
 - set "DATE/TIME" to "AUTO", "ON" or "OFF" in the Menu Screen (☞ pg. 32).
 - Or, press **DISPLAY** on the remote control to turn on/off the date indication.
- Time Code
 - set "TIME CODE" to "ON" or "OFF" in the Menu Screen (☞ pg. 32).
- Playback Sound Mode, Tape Speed And Tape Running Displays
 - set "ON SCREEN" to "LCD" or "LCD/TV" in the Menu Screen (☞ pg. 32).
- In order to maintain optimum performance of the camcorder, provided cables may be equipped with one or more core filter. If a cable has only one core filter, the end that is closest to the filter should be connected to the camcorder.
- Make sure to set "S/AV INPUT" to "OFF" in the Menu Screen (☞ pg. 32).
- When editing on a VCR equipped with a DV input connector, an optional DV cable can be connected instead of an S-Video cable and audio/video cable.

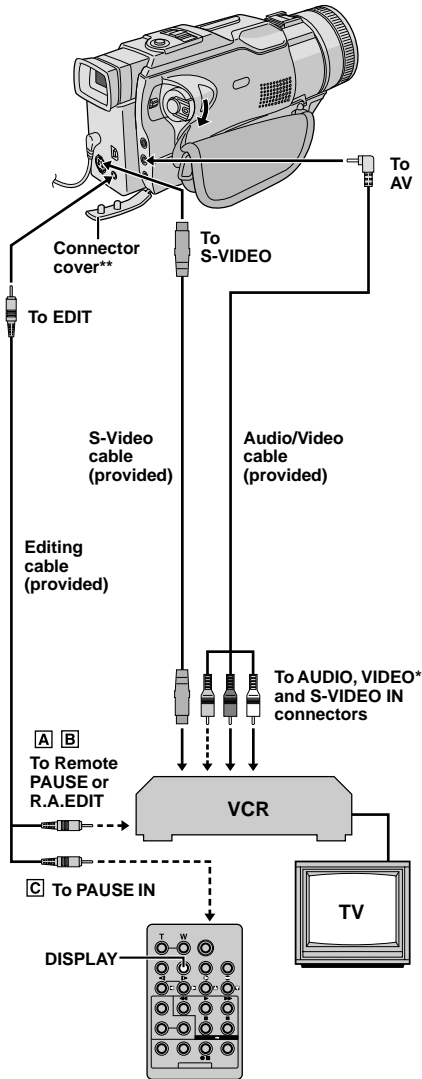

* Connect when an S-Video cable is not used.

** When connecting cables, open this cover.

Programme

	IN	OUT	MODE
1	---	---	---
2	---	---	---
3	---	---	---
4	---	---	---
5	---	---	---
6	---	---	---
7	---	---	---
8	---	---	---
TIME CODE			---
TOTAL			00:00

Random Assemble Editing Menu

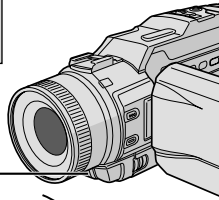

Remote sensor

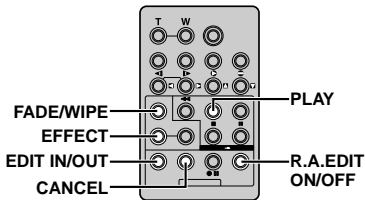

Fader And Wipe Menu (available only for Random Assemble Editing)

You can also use the fade/wipe effects on page 37.

DISSOLVE

The new scene gradually appears as the old one gradually disappears.

WIPE — CORNER

The new scene wipes in over the previous one from the upper right corner to the lower left corner.

WIPE — WINDOW

The next scene gradually wipes in from the centre of the screen toward the corners, covering the previous scene.

WIPE — SLIDE

The next scene gradually wipes in over the previous one from right to left.

WIPE — DOOR

The previous scene wipes out from the centre to the right and left, like a door being pushed open to reveal the next scene.

WIPE — SCROLL

The new scene wipes in over the last one from the bottom of the screen to the top.

WIPE — SHUTTER

The new scene wipes in over the previous one from the centre toward the top and bottom of the screen.

SELECT SCENES

4 Point the remote control at the camcorder's remote sensor. Press **PLAY** (▶) and then press **R.A.EDIT ON/OFF** on the remote control. The Random Assemble Editing Menu appears.

5 If using a Fade/Wipe at the beginning of the scene, press **FADE/WIPE** on the remote control.

- Cycle through the effects by pressing repeatedly, and stop when the one you want is displayed.
- You cannot use a Picture Wipe/Dissolve at the beginning of Programme 1.

6 At the beginning of the scene, press **EDIT IN/OUT** on the remote control. The Edit-In position appears in the Random Assemble Editing Menu.

7 At the end of the scene, press **EDIT IN/OUT**. The Edit-Out position appears in the Random Assemble Editing Menu.

8 If using a Fade/Wipe at the end of the scene, press **FADE/WIPE**.

- Cycle through the effects by pressing repeatedly, and stop when the one you want is displayed.
- If you select a Fade/Wipe effect for an Edit-Out point, the effect is automatically applied to the following Edit-In point.
- You cannot use a Picture Wipe/Dissolve at the end of the last scene.
- When you use Fade/Wipe effects, that time is included in the total time (this does not apply to Picture Wipe/Dissolve).

9 If using Playback Special Effects, press **EFFECT** (pg. 65).

10 Repeat steps **6** through **9** to register additional scenes.

- To change previously registered points, press **CANCEL** on the remote control. The registered points disappear, one at a time, from the most recently registered point.
- If you are not using Fade/Wipe or Programme AE with special effects, repeat steps **6** and **7** only.

NOTES:

- When choosing a scene, set Edit-In and Edit-Out points so that there is a relatively large difference between them.
- If the search time for an in-point exceeds 5 minutes, the recording deck's Record-Standby mode will be cancelled and editing will not take place.
- If there are blank portions before or after the Edit-In and Edit-Out points, a blue screen may be included in the edited version.
- Since time codes register time only as accurately as seconds, the time code total time may not match the total programme time exactly.
- Turning off the camcorder's power erases all registered Edit-In and Edit-Out points.
- If you select Sepia or Monotone mode from Programme AE with special effects, you cannot use the Dissolve or Black & White Fader. In this case the Dissolve or Black & White indicator begins blinking. Once the next Edit-In point is registered, the effect is turned off. To combine these effects, use Sepia or Monotone during recording, then use the Dissolve or Black & White Fader during Random Assemble Editing.
- It is not possible to use Fade/Wipe effects and Programme AE with special effects during Random Assemble Editing using a DV cable.

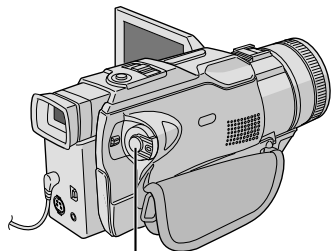

Recording Start/Stop Button

	IN	OUT	MODE
1	00:25	02:05	-- --
2	07:18	08:31	-- --
3	03:33	05:53	[] BW
4	09:30	13:15	[] []
5	15:55	16:29	[] []
6			
7			
8			
TIME CODE		16:30	
TOTAL		9:39	

Random Assemble Editing Menu

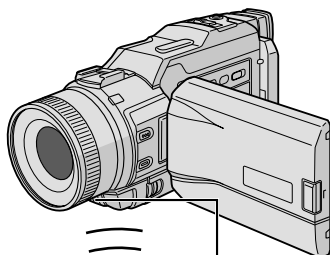

Remote Sensor

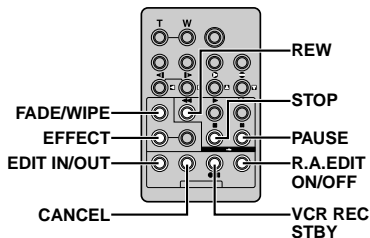

AUTOMATIC EDITING TO VCR

11 Rewind the tape in the camcorder to the beginning of the scene you want to edit and press **PAUSE (II)**.

12 Point the remote control towards the VCR's remote sensor and press **VCR REC STBY (●II)**, or manually engage the VCR's Record-Pause mode.

13 Press the Recording Start/Stop Button on the camcorder. Editing proceeds as programmed, right through to the end of the last registered scene.

- When dubbing is complete, the camcorder enters the Pause mode, and the VCR enters its Record-Pause mode.
- If you do not register an Edit-Out point, the tape will be dubbed all the way to the end automatically.
- If you operate the camcorder during automatic editing, the VCR will enter its Record-Pause mode and automatic editing will stop.

14 Engage the Stop modes for the camcorder and the VCR.

To make the R.A.Edit counter display disappear, press **R.A.EDIT ON/OFF** on the remote control.

NOTES:

- Pressing **R.A.EDIT ON/OFF** on the remote control clears all settings registered during Random Assemble Editing.
- When the editing cable is connected to the remote control's Pause In connector during dubbing, make sure the remote control is pointed at the VCR's sensor, and the path between the two is unobstructed.
- Random Assemble Editing may not function properly when using a tape including several duplicated time codes (see pg. 23).

CONTINUED ON NEXT PAGE

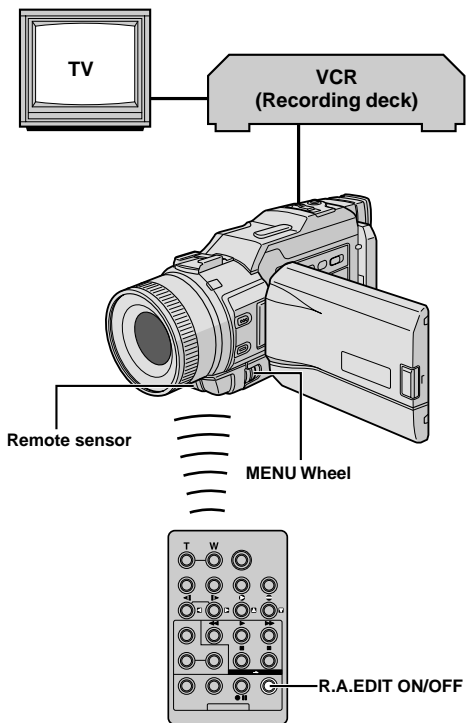
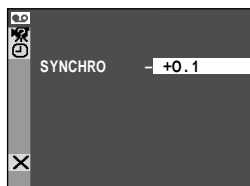
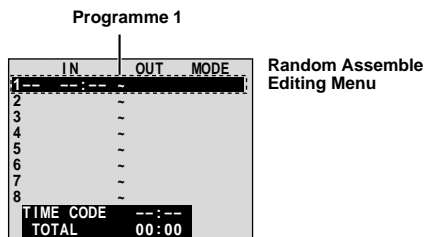

For More Accurate Editing

Some VCRs make the transition from Record-Pause to Record mode faster than others. Even if you begin editing for the camcorder and the VCR at exactly the same time, you may lose scenes you wanted, or find that you have recorded scenes you did not want. For a cleanly edited tape, confirm and adjust the timing of the camcorder against your VCR.

DIAGNOSING VCR/CAMCORDER TIMING

- 1 Play back the tape in the camcorder, then point the remote control at the camcorder's remote sensor and press **R.A.EDIT ON/OFF**. The Random Assemble Editing Menu appears.
- 2 Perform Random Assemble Editing on Programme 1 only. In order to check VCR and camcorder timing, select the beginning of a scene transition as your Edit-In point.
- 3 Play back the dubbed scene.
 - If any images from the scene prior to the transition you chose for your Edit-In point were recorded, that means your VCR moves too quickly from Record-Pause to Record mode.
 - If the scene you tried to dub starts in progress, the VCR is slow to start recording.

ADJUSTMENT OF VCR/CAMCORDER TIMING

- 4 Point the remote control at the camcorder's remote sensor and press **R.A.EDIT ON/OFF** to make the Random Assemble Editing menu disappear, then press the **MENU** wheel in. The Menu Screen appears.
- 5 Rotate the **MENU** wheel to select "**VIDEO**" and press it. The VIDEO Menu appears. Then, rotate it to "SYNCHRO" and press it. The value for "SYNCHRO" is highlighted.
- 6 Based on the diagnostics performed, you can now advance the VCR's record timing by rotating the **MENU** wheel towards "▲". You can also delay the VCR's record timing by rotating the **MENU** wheel towards "▼". The adjustment range is from -1.3 to +1.3 seconds, in 0.1-second increments. Press the **MENU** wheel in to finish the setting.
- 7 Rotate the **MENU** wheel to select "**RETURN**" and press it twice. Now perform Random Assemble Editing beginning with step 4 on page 68.

NOTES:

- Before performing actual Random Assemble Editing, do a few Random Assemble Editing trial runs to check whether the value you have input is appropriate or not, and make adjustments accordingly.
- Depending on the recorder, there may be situations where the timing difference cannot be fully corrected.

Display



Power Switch

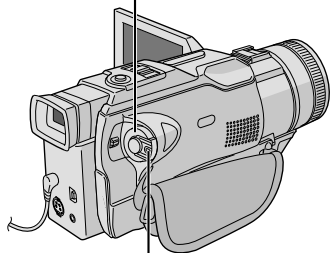

Lock Button

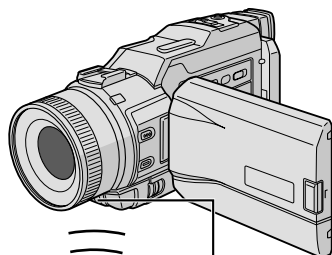

Remote sensor

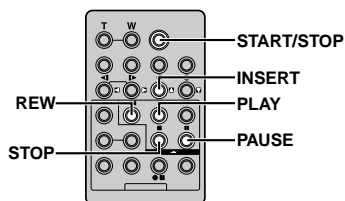

Insert Editing

You can record a new scene into a previously recorded tape, replacing a section of the original recording with minimal picture distortion at the in and outpoints. The original audio remains unchanged.

NOTES:

- Before performing the following steps, make sure that "TIME CODE" is set to "ON" in the Menu Screen (☞ pg. 31, 33).
- Insert Editing is not possible on a tape recorded in the LP mode or on a blank portion of a tape.
- To perform Insert Editing while watching in the television, make connections (☞ pg. 54).

1 Play back the tape, locate the Edit-Out point and press **PAUSE (II)**. Confirm the time code at this point (☞ pg. 31, 33).

2 Press **REW (◀)** until the Edit-In point is located, then press **PAUSE (II)**.

3 Press and hold **INSERT (C)** on the remote control, then press **PAUSE (II)**. "IIC" and the Time Code (min.:sec.) appear and the camcorder enters Insert-Pause mode.

4 Press **START/STOP** to begin editing.

- Confirm the insert at the time code you checked in step 1.
- To pause editing, press **START/STOP**. Press it again to resume editing.

5 To end Insert Editing, press **START/STOP**, then **STOP (■)**.

NOTES:

- Programme AE with special effects (☞ pg. 38, 39) can be used to spice up the scenes being edited during Insert Editing.
- During Insert Editing, the date and time information changes.
- If you perform Insert Editing onto a blank space on the tape, the audio and video may be disrupted. Make sure you only edit recorded areas.
- During Insert Editing, when the tape moves to scenes recorded in the LP mode or a blank portion, Insert Editing stops (☞ pg. 87, 88).
- If a memory card is loaded and "NAVIGATION" is set to "ON", a NAVIGATION thumbnail image is stored in the memory card (☞ pg. 42).

Display



Audio Dub Standby mode

Power Switch

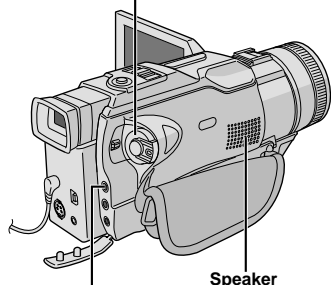
PHONE
(headphone)
connector*

Speaker

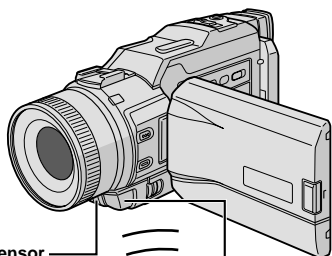

Remote sensor

Stereo microphone

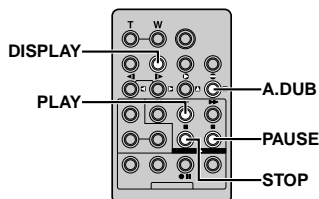

Audio Dubbing

The audio track can be customized only when recorded in the 12-bit mode (☞ pg. 29).

NOTES:

- Audio Dubbing is not possible on a tape recorded in 16-bit audio, on a tape recorded in the LP mode or on a blank portion of a tape.
- To perform Audio Dubbing while watching on the television, make connections (☞ pg. 54).

1 Play back the tape to locate the point where editing will start, then press **PAUSE** (⏸).

2 While holding **A.DUB** (⏸) on the remote control, press **PAUSE** (⏸). "⏸" appears.

3 Press **PLAY** (▶), then begin "narrating". Speak into the microphone.

- To pause dubbing, press **PAUSE** (⏸).

4 To end Audio Dubbing, press **PAUSE** (⏸), then **STOP** (■).

To hear the dubbed sound during playback . . .

..... set "12BIT MODE" to "SOUND 2" or "MIX" in the Menu Screen (☞ pg. 32, 33).

NOTES:

- Sound is not heard from the speaker during Audio Dubbing. To hear sound, connect optional headphones to the PHONE connector.
- When editing onto a tape that was recorded at 12-bit, the old and new soundtracks are recorded separately.
- If you dub onto a blank space on the tape, the sound may be disrupted. Make sure you only edit recorded areas.
- If feedback or howling occurs during TV playback, move the camcorder's microphone away from the TV, or turn down the TV's volume.
- If you change from 12-bit to 16-bit in mid-recording and then use the tape for Audio Dubbing, it is not effective from the point where 16-bit recording began.
- During Audio Dubbing, when the tape moves to scenes recorded in the LP mode, scenes recorded in 16-bit audio or a blank portion, Audio Dubbing stops (☞ pg. 87).
- To perform Audio Dubbing with a video unit connected to the camcorder's AV connector, first set "S/AV INPUT" to "ON", then "SOUND IN" to "MIC/AUX" in the Menu Screen (☞ pg. 32). You can hear sound from the video unit using optional headphones.
- If "SOUND IN" is set to "D.SOUND" in the Menu Screen, Digital Sound Effect will be dubbed instead of the microphone input (☞ pg. 73).

* Located beneath the cover.

Display

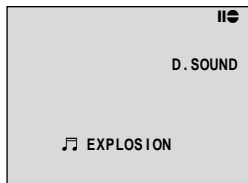

Audio Dub Standby mode

Power Switch

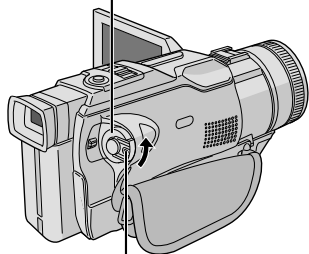

Lock Button

D. SOUND Button

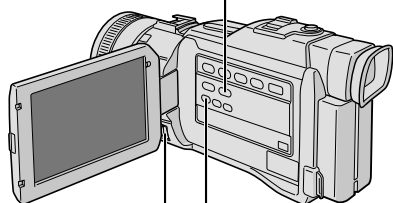

INDEX Button

MENU Wheel

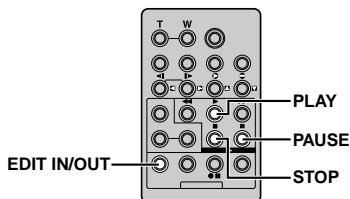

Audio Dubbing Using Digital Sound Effects

- 1** Load the provided memory card (☞ pg. 13) and perform step 1 and 2 of page 72.
- 2** Press the **MENU** wheel in. The Menu Screen appears.
- 3** Rotate the **MENU** wheel to select "**SYSTEM**", and press it.
- 4** Rotate the **MENU** wheel to select "SOUND IN", and press it. Rotate the **MENU** wheel to select "D.SOUND" and press it.
- 5** Press the **MENU** wheel in twice.
- 6** Press **INDEX** to display the SOUND Index Screen (☞ pg. 27, 45), then use the **MENU** wheel to select the desired sound effect.
- 7** Press **PLAY** (▶) to begin Audio Dubbing, then press **D.SOUND** where you want to use the sound effect.
 - The displayed sound effect blinks while it is being dubbed.
 - To stop dubbing the sound effect midway, press **D. SOUND** again.
- 8** Press **STOP** (■) to end Audio Dubbing.

NOTES:

- Be sure to set "SOUND IN" back to "MIC" after Audio Dubbing.
- The dubbed sound effect is recorded on SOUND 2 (☞ pg. 33).
- If you press **PAUSE** (⏸) to pause dubbing in step 7 the selected sound effect indication remains displayed.
- If you press **STOP** (■) to end Audio Dubbing in step 8 the selected sound effect continues to be heard from the connected headphones (optional); press **D. SOUND** to stop the sound effect.

If, after following the steps in the chart below, the problem still exists, please consult your nearest JVC dealer.

The camcorder is a microcomputer-controlled device. External noise and interference (from a TV, a radio, etc.) might prevent it from functioning properly. In such cases, first disconnect its power supply unit (battery pack, AC Power Adapter/Battery Charger, etc.) and wait a few minutes; and then re-connect it and proceed as usual from the beginning.

SYMPTOM	POSSIBLE CAUSES	CORRECTIVE ACTION
1 No power is supplied.	<ul style="list-style-type: none"> • The power is not connected properly. • The battery is dead. • The LCD monitor is not open fully or the viewfinder is not pulled out when recording. 	<ul style="list-style-type: none"> • Connect the AC Power Adapter/Charger securely (☞ pg. 9). • Replace the dead battery with a fully charged one (☞ pg. 8, 9). • Open the LCD monitor fully or pull out the viewfinder.
2 "SET DATE/TIME!" appears.	<ul style="list-style-type: none"> • The date/time is not set. • The built-in clock battery has run out and the previously set date/time has been erased. 	<ul style="list-style-type: none"> • Set the date/time (☞ pg. 11). • Consult your nearest JVC dealer for replacement.
3 Recording cannot be performed.	<p>— For Tape Recording —</p> <ul style="list-style-type: none"> • The tape's erase protection tab is set to "SAVE". • The Power Switch is set to "PLAY" or "OFF". • The VIDEO/MEMORY Switch is set to "MEMORY". • "TAPE END" appears. • The cassette holder cover is open. <p>— For Memory Card Recording —</p> <ul style="list-style-type: none"> • The VIDEO/MEMORY Switch is set to "VIDEO". 	<ul style="list-style-type: none"> • Set the tape's erase protection tab to "REC" (☞ pg. 12). • Set the Power Switch to "A" or "M" (☞ pg. 17). • Set the VIDEO/MEMORY Switch to "VIDEO". • Replace with new cassette (☞ pg. 12). • Close the cassette holder cover. • Set the VIDEO/MEMORY Switch to "MEMORY".
4 There is no picture.	<ul style="list-style-type: none"> • The camcorder is not getting power, or some other malfunction exists. 	<ul style="list-style-type: none"> • Turn the camcorder's power off and on again (☞ pg. 14).
5 Some functions are not available using the MENU wheel.	<ul style="list-style-type: none"> • The Power Switch is set to "A". 	<ul style="list-style-type: none"> • Set the Power Switch to "M" (☞ pg. 14).
6 The focus does not adjust automatically.	<ul style="list-style-type: none"> • Focus is set to the Manual mode. • The recording was done in a dark place, or the contrast was low. • The lens is dirty or covered with condensation. 	<ul style="list-style-type: none"> • Set Focus to the Auto mode (☞ pg. 24). • Clean the lens and check the focus again (☞ pg. 80).

SYMPTOM	POSSIBLE CAUSES	CORRECTIVE ACTION
7 The cassette will not load properly.	<ul style="list-style-type: none"> • The cassette is in the wrong position. • The battery's charge is low. 	<ul style="list-style-type: none"> • Set it in the right position (☞ pg. 12). • Install a fully charged battery (☞ pg. 8, 9).
8 The memory card will not load properly.	<ul style="list-style-type: none"> • The memory card is in the wrong position. 	<ul style="list-style-type: none"> • Set it in the right position (☞ pg. 13).
9 In the 5-Second mode, recording ends before 5 seconds have elapsed.	<ul style="list-style-type: none"> • The 5-Second mode is set to "Anim." in the Menu Screen. 	<ul style="list-style-type: none"> • Select "5S" in the Menu Screen (☞ pg. 35).
10 Snapshot mode cannot be used.	<ul style="list-style-type: none"> • The Squeeze mode is selected. 	<ul style="list-style-type: none"> • Disengage the Squeeze mode (☞ pg. 30).
11 The colour of Snapshot looks strange.	<ul style="list-style-type: none"> • The light source or the subject does not include white. Or there are various different light sources behind the subject. • The Sepia or Monotone mode is activated. 	<ul style="list-style-type: none"> • Find a white subject and compose your shot so that it also appears in the frame (☞ pg. 20, 21). • Turn off Sepia and Monotone (☞ pg. 38, 39).
12 The image taken using Snapshot is too dark.	<ul style="list-style-type: none"> • Shooting was performed under backlit conditions. 	<ul style="list-style-type: none"> • Press the BACKLIGHT Button (☞ pg. 40).
13 The image taken using Snapshot is too bright.	<ul style="list-style-type: none"> • The subject is too bright. 	<ul style="list-style-type: none"> • Set "PROGRAM AE" to "SPOT-LIGHT" in the Menu Screen (☞ pg. 38).
14 Digital Zoom does not work.	<ul style="list-style-type: none"> • 10X optical zoom is selected. • The VIDEO/MEMORY Switch is set to "MEMORY". 	<ul style="list-style-type: none"> • Set "ZOOM" to "40X" or "300X" in the Menu Screen (☞ pg. 29). • Set the VIDEO/MEMORY Switch to "VIDEO" (☞ pg. 14, 22).
15 Programme AE with special effects and Fade/Wipe Effects do not work.	<ul style="list-style-type: none"> • The Power Switch is set to "A". 	<ul style="list-style-type: none"> • Set the Power Switch to "M" (☞ pg. 36, 38).
16 The Black & White Fader does not work.	<ul style="list-style-type: none"> • The Sepia or Monotone mode is activated. 	<ul style="list-style-type: none"> • Turn off Sepia and Monotone (☞ pg. 36, 38).
17 During R.A.Edit, the Dissolve function does not work.	<ul style="list-style-type: none"> • The Sepia or Monotone mode of Programme AE with special effects is activated. • The previously selected mode of Programme AE with special effects was changed after the last selected scene for editing was registered. 	<ul style="list-style-type: none"> • Turn off Sepia or Monotone before adding Dissolve to a scene transition (☞ pg. 38, 68). • Make sure you have selected the mode of Programme AE with special effects you want before starting editing (☞ pg. 38, 68).

CONTINUED ON NEXT PAGE

SYMPTOM	POSSIBLE CAUSES	CORRECTIVE ACTION
18 During R.A.Edit, the Picture Wipe and Dissolve functions do not work.	<ul style="list-style-type: none"> • The last selected editing scene is ending. • At the end of the last selected scene for editing, the Power switch was set to "OFF". • The power is off. 	<ul style="list-style-type: none"> • Select Picture Wipe or Dissolve before beginning editing. The effects are then automatically activated (☞ pg. 68). • Do not turn off the camcorder's power after setting Edit-In and Edit-Out points, as they will all be erased (☞ pg. 68). • The camcorder automatically shuts off after 5 minutes have elapsed in the Pause mode. Make sure you continue operations within 5 minutes after engaging Pause mode (☞ pg. 68).
19 Scene transition does not go as expected.	<ul style="list-style-type: none"> • When using "Picture Wipe/Dissolve" (☞ pg. 68), there is a delay of a fraction of a second between the previous record stop-point and the Dissolve start-point. This is normal, but this slight delay becomes especially noticeable when shooting fast-moving subject or during rapid panning. 	<p style="text-align: center;">_____</p>
20 White Balance cannot be activated.	<ul style="list-style-type: none"> • The Sepia or Monotone mode is activated. 	<ul style="list-style-type: none"> • Turn off Sepia or Monotone before setting White Balance (☞ pg. 39, 41).
21 When shooting a subject illuminated by bright light, vertical lines appear.	<ul style="list-style-type: none"> • This is a result of exceedingly high contrast, and is not a malfunction. 	<p style="text-align: center;">_____</p>
22 When the screen is under direct sunlight during shooting, the screen becomes red or black for an instant.	<ul style="list-style-type: none"> • This is not a malfunction. 	<p style="text-align: center;">_____</p>
23 During recording, the date/time does not appear.	<ul style="list-style-type: none"> • "DATE/TIME" is set to "OFF" in the Menu Screen. • Interface Shooting is performed. 	<ul style="list-style-type: none"> • Set "DATE/TIME" to "ON" in the Menu Screen (☞ pg. 31). • During Interface Shooting, the date/time does not appear (☞ pg. 19).
24 Files stored on the memory card cannot be deleted.	<ul style="list-style-type: none"> • Files stored on the memory card are protected. 	<ul style="list-style-type: none"> • Remove protection from the files stored on the memory card and delete them (☞ pg. 49, 50).

SYMPTOM	POSSIBLE CAUSES	CORRECTIVE ACTION
25 Time code does not appear.	<ul style="list-style-type: none"> • "TIME CODE" is set to "OFF" in the Menu Screen. 	<ul style="list-style-type: none"> • Set "TIME CODE" to "ON" in the Menu Screen (☞ pg. 31, 32).
26 Images on the LCD monitor appear dark or whitish.	<ul style="list-style-type: none"> • In places subject to low temperature, images become dark due to the characteristics of the LCD monitor. When this happens, the displayed colours differ from those that are actually recorded. This is not a defect of the camcorder. • When the LCD monitor's fluorescent light reaches the end of its service life, images on the LCD monitor become dark. Consult your nearest JVC dealer. 	<ul style="list-style-type: none"> • Adjust the brightness and angle of the LCD monitor (☞ pg. 18, 19).
27 The rear of the LCD monitor is hot.	<ul style="list-style-type: none"> • The light used to illuminate the LCD monitor causes it to become hot. 	<ul style="list-style-type: none"> • Close the LCD monitor to turn it off or set the Power Switch to "OFF", and let the unit cool down.
28 The indicators and the image colour on the LCD monitor are not clear.	<ul style="list-style-type: none"> • This may occur when the surface or the edge of the LCD monitor is pressed. 	<p style="text-align: center;">—————</p>
29 The LCD monitor or viewfinder indications blink.	<ul style="list-style-type: none"> • Certain Fade/Wipe effects, certain modes of Programme AE with special effects, "DIS" and other functions that cannot be used together are selected at the same time. 	<ul style="list-style-type: none"> • Re-read the sections covering Fade/Wipe effects, Programme AE with special effects and "DIS" (☞ pg. 29, 36 – 39).
30 Coloured bright spots appear all over the LCD monitor or the viewfinder.	<ul style="list-style-type: none"> • The LCD monitor and the viewfinder are made with high-precision technology. However, black spots or bright spots of light (red, green or blue) may appear constantly on the LCD monitor or the viewfinder. These spots are not recorded on the tape. This is not due to any defect of the unit. (Effective dots: more than 99.99 %) 	<p style="text-align: center;">—————</p>

CONTINUED ON NEXT PAGE

SYMPTOM	POSSIBLE CAUSES	CORRECTIVE ACTION
31 During recording, sound cannot be heard.	<ul style="list-style-type: none"> • The optional headphones are not connected to the headphone connector. • The sound volume of the headphone connector was not adjusted appropriately. The sound volume at this point is the same as the level it was adjusted to during playback. 	<ul style="list-style-type: none"> • Connect the optional headphones to the headphone connector (☞ pg. 82, 83). • Adjust the sound volume during playback (☞ pg. 25).
32 Play, Rewind and Fast-Forward functions do not work.	<ul style="list-style-type: none"> • The Power Switch is set to “A” or “M”. 	<ul style="list-style-type: none"> • Set the Power Switch to “PLAY” (☞ pg. 25).
33 A memory card cannot be played back.	<ul style="list-style-type: none"> • The Power Switch is set to “A” or “M”. • The VIDEO/MEMORY Switch is set to “VIDEO”. 	<ul style="list-style-type: none"> • Set the Power Switch to “PLAY” (☞ pg. 26). • Set the VIDEO/MEMORY Switch to “MEMORY”.
34 The tape is moving, but there is no picture.	<ul style="list-style-type: none"> • Your TV has AV input terminals, but is not set to its VIDEO mode. • The cassette holder cover is open. 	<ul style="list-style-type: none"> • Set the TV to the mode or channel appropriate for tape playback (☞ pg. 54, 55). • Close the cassette holder cover (☞ pg. 12).
35 The LCD monitor image is distorted.	<ul style="list-style-type: none"> • During playback of the unrecorded portion, High-speed Search and still playback, LCD monitor indications appear distorted. This is not a defect. 	<p style="text-align: center;">_____</p>
36 Images on the LCD monitor are jittery.	<ul style="list-style-type: none"> • The speaker volume is too great. 	<ul style="list-style-type: none"> • Turn the speaker volume down (☞ pg. 25).
37 There is no playback picture on the connected TV.	<ul style="list-style-type: none"> • Since the analogue input mode is engaged, the camcorder is in the Record-Standby mode. 	<ul style="list-style-type: none"> • Set “S/AV INPUT” to “OFF” in the Menu Screen (☞ pg. 32).
38 Blocks of noise appear during playback, or there is no playback picture and the screen becomes blue.	<p style="text-align: center;">_____</p>	<ul style="list-style-type: none"> • Clean the video heads with an optional cleaning cassette (☞ pg. 90).
39 The LCD monitor, the viewfinder and the lens have become dirty (ex. fingerprints).	<p style="text-align: center;">_____</p>	<ul style="list-style-type: none"> • Wipe them gently with soft cloth. Wiping strongly can cause damage (☞ pg. 80).

SYMPTOM	POSSIBLE CAUSES	CORRECTIVE ACTION
40 An unusual mark appears.	—————	<ul style="list-style-type: none"> • Check the section of the manual that explains LCD monitor/viewfinder indications (☞ pg. 84 – 88).
41 An error indication (E01, E02 or E06) appears.	<ul style="list-style-type: none"> • A malfunction of some kind has occurred. In this case the camcorder's functions become unusable. 	<ul style="list-style-type: none"> • Remove the power supply (battery pack, etc.) and wait a few minutes for the indication to clear. When it does, you can resume using the camcorder. If the indication remains even though you repeat the above two or three times, please consult your nearest JVC dealer. Do not eject the cassette. This will cause damage to the tape.
42 An error indication (E03 or E04) appears.	<ul style="list-style-type: none"> • A malfunction of some kind has occurred. In this case the camcorder's functions become unusable. 	<ul style="list-style-type: none"> • Eject the cassette once and re-insert it, then check if the indication clears. When it does, you can resume using the camcorder. If the indication remains even though you repeat the above two or three times, please consult your nearest JVC dealer.
43 The charger indicator on the AC Power Adapter/Charger does not light.	<ul style="list-style-type: none"> • The temperature of the battery is extremely high/low. • Charging is difficult in places subject to extremely high/low temperatures. 	<ul style="list-style-type: none"> • To protect the battery, it is recommended to charge it in places with a temperature of 10°C to 35°C (☞ pg. 89).
44 Picture does not appear on the LCD monitor.	<ul style="list-style-type: none"> • The viewfinder is pulled out. • The LCD monitor's brightness setting is too dark. 	<ul style="list-style-type: none"> • Push the viewfinder back in. • Adjust the brightness of the LCD monitor (☞ pg. 18). • If the monitor is tilted upward 180 degrees, open the monitor fully (☞ pg. 18).
45 When the image is printed from the printer, a black bar appears at the bottom of the screen.	<ul style="list-style-type: none"> • This is not a malfunction. 	<ul style="list-style-type: none"> • By recording with "DIS" activated (☞ pg. 29) this can be avoided.
46 When the camcorder is connected via the DV connector, the camcorder does not operate.	<ul style="list-style-type: none"> • The DV cable was plugged/unplugged with power turned on. 	<ul style="list-style-type: none"> • Turn the camcorder's power off and on again, then operate it.
47 The memory card cannot be removed from the camcorder.	—————	<ul style="list-style-type: none"> • Push in the memory card a few more times (☞ pg. 13).

After Use

- 1** Turn off the camcorder.
- 2** Slide and hold **OPEN/EJECT** in the direction of the arrow, then pull the cassette holder cover open until it locks. The cassette holder opens automatically. Remove the cassette.
- 3** Press "PUSH HERE" to close the cassette holder.
 - Once the cassette holder is closed, it recedes automatically. Wait until it recedes completely before closing the cassette holder cover.
- 4** Slide **BATT. RELEASE** ① and remove the battery pack ②.

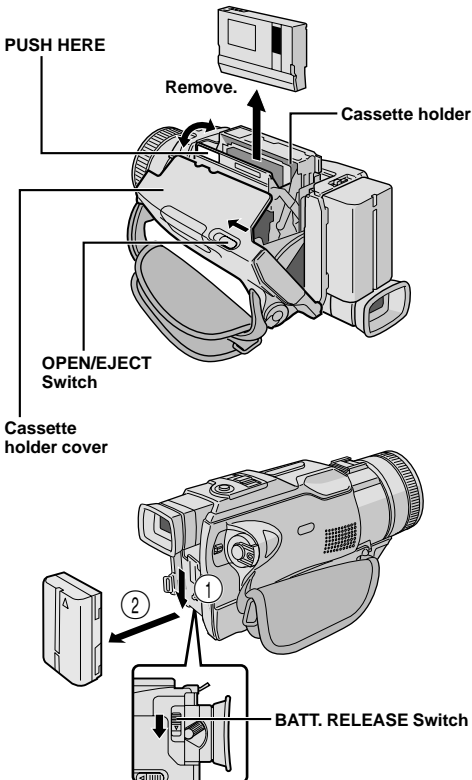

Cleaning The Camcorder

- 1** To clean the exterior, wipe gently with a soft cloth. Put the cloth in diluted mild soap and wring it well to wipe off heavy dirt. Then wipe again with a dry cloth.
- 2** Press **PUSH OPEN** and open the LCD monitor. Wipe gently with a soft cloth. Be careful not to damage the monitor. Close the LCD monitor.
- 3** To clean the lens, blow it with a blower brush, then wipe gently with lens cleaning paper.
- 4** To clean the viewfinder, raise it to the vertical position. Carefully lift the plastic tab on the bottom of the viewfinder, and open the hatch ①.
- 5** Insert a lens blower or soft cloth into the gap at the bottom of the viewfinder and clean the interior of the viewfinder with it ②.
- 6** Close the hatch. Tilt the viewfinder back to the horizontal position and push it back in.

NOTES:

- Avoid using strong cleaning agents such as benzine or alcohol.
- Cleaning should be done only after the battery pack has been removed or other power units have been disconnected.
- Mould may form if the lens is left dirty.
- When using a cleaner or chemically treated cloth refer to the cautions of each product.

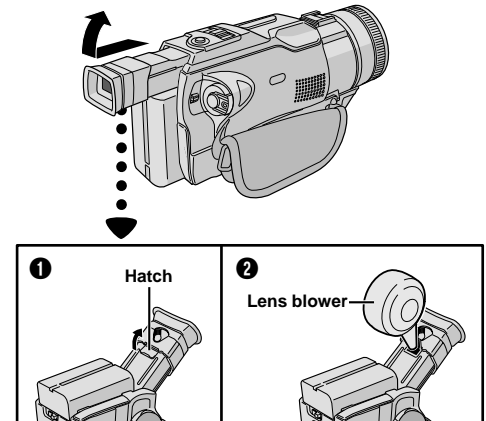

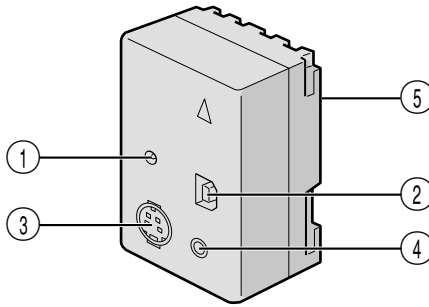

- ① DC Input Connector [DC IN] pg. 9
- ② USB (Universal Serial Bus) Connector pg. 56, 57
- ③ S-Video Input/Output Connector [S-VIDEO] pg. 54, 67
- ④ Edit Connector [EDIT] pg. 67
Connect the editing cable when performing Random Assemble Editing pg. 66 – 70
- ⑤ Multi Connector
The Jack Box can be connected with this camcorder through this connector. Never touch it with your hand or hit it with a hard object; if the pins are damaged, the connectors will become unusable due to contact failure.

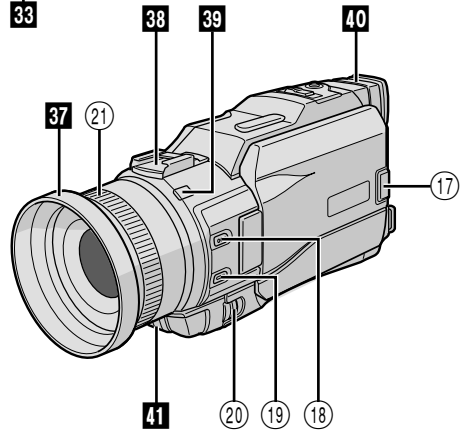
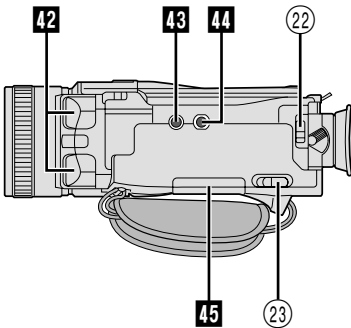
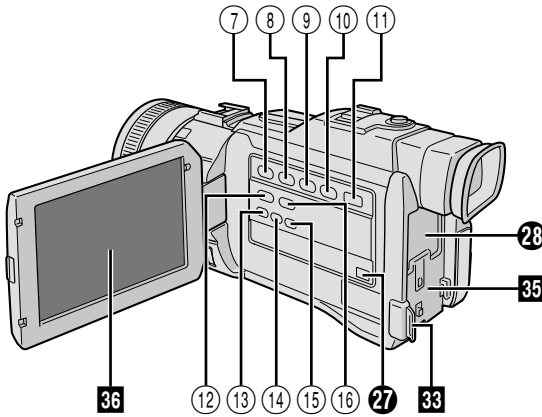
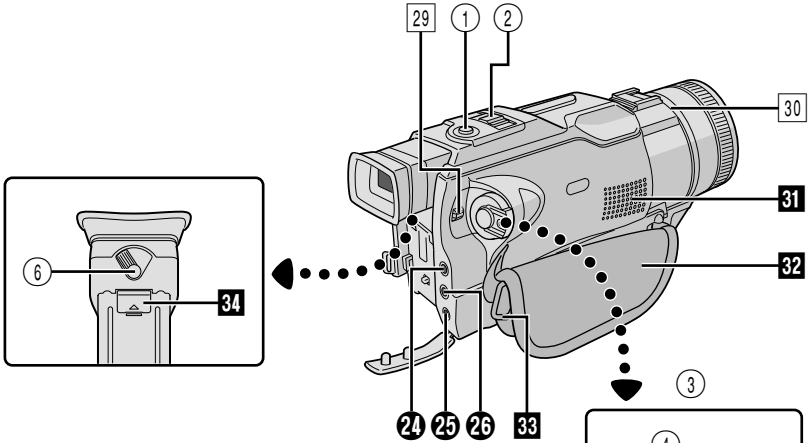

Controls

- ① Snapshot Button
[SNAPSHOT] pg. 20, 21, 61
- ② • Power Zoom Lever [T/W] pg. 22
- Speaker/Headphone Volume Control
[VOLUME] pg. 25
- ③ Power Switch [**A** , **M** , **PLAY** , OFF] pg. 14
- ④ Recording Start/Stop Button pg. 18
- ⑤ Lock Button pg. 14
- ⑥ Dioptre Adjustment Control pg. 10
- ⑦ • Stop Button [**■**] pg. 25
- Programme AE Button [PROG.AE] pg. 38
- ⑧ • Rewind Button [**◀◀**] pg. 25
- NIGHT Button pg. 38
- ⑨ • Play/Pause Button [**▶/||**] pg. 25
- BACKLIGHT Button pg. 40
- ⑩ • Fast-Forward Button [**▶▶**] pg. 25
- FADE/WIPE Button pg. 36
- ⑪ VIDEO/MEMORY Switch
[VIDEO, MEMORY] pg. 14
- ⑫ TITLE Button pg. 48
- ⑬ INDEX Button pg. 27, 45, 48
- ⑭ • NAVI Button pg. 42
- SELECT Button pg. 26, 49 – 53
- ⑮ • E-MAIL Button pg. 46
- INFO Button pg. 27
- ⑯ D. SOUND Button pg. 45
- ⑰ Monitor Open Button [PUSH OPEN] pg. 18
- ⑱ FOCUS Button pg. 24
- ⑲ EXPOSURE Button pg. 40
- ⑳ • MENU Wheel [**▲**, **▼**, PUSH] pg. 28
- LCD Monitor Brightness Control pg. 18
- ㉑ Manual Focus Ring pg. 24
- ㉒ Battery Release Switch
[BATT. RELEASE] pg. 9
- ㉓ OPEN/EJECT Switch pg. 12

Connectors

The connectors ㉔ to ㉖ are located beneath a cover.

- ㉔ Headphone Connector [PHONE] pg. 72
- No sound is output from the speaker when headphones are connected to this connector.

- ㉕ PRINTER Connector
Connect to the optional printer equipped with a PRINT DATA connector. Refer to the separate “FOR OWNERS OF AN OPTIONAL PRINTER” instruction sheet.
- ㉖ Audio/Video Input/Output Connector
[AV] pg. 54, 59, 67
- To connect a cable to the connector ㉗, open the LCD monitor.
- ㉗ Digital Video Connector
[DV IN/OUT] (i.Link*) pg. 56, 58, 60
- *i.Link refers to the IEEE1394-1995 industry specification and extensions thereof. The logo is used for products compliant with the i.Link standard.
- ㉘ Multi Connector
When attaching the Jack Box to the camcorder, this part is connected.

Indicators

- ㉙ Power Lamp pg. 18
- ㉚ Tally Lamp pg. 18

Other Parts

- ㉛ Speaker pg. 42
- ㉜ Grip Strap pg. 10
- ㉝ Shoulder Strap Eyelets pg. 10
- ㉞ Viewfinder Cleaning Hatch pg. 80
- ㉟ Battery Pack Mount pg. 9
- ㊱ LCD Monitor pg. 18, 19
- ㊲ Lens Hood pg. 6
- ㊳ Info-Shoe
Attach the optional video light/flash/zoom microphone.
- ㊴ Camera Sensor
Be careful not to cover this area, a sensor necessary for shooting is built-in here.
- ㊵ Viewfinder pg. 10
- ㊶ Remote Sensor pg. 62
- ㊷ Stereo Microphone pg. 72
- ㊸ Stud Hole pg. 10
- ㊹ Tripod Mounting Socket pg. 10
- ㊺ MEMORY CARD Cover pg. 13

LCD Monitor/Viewfinder Indications During Tape Recording Only

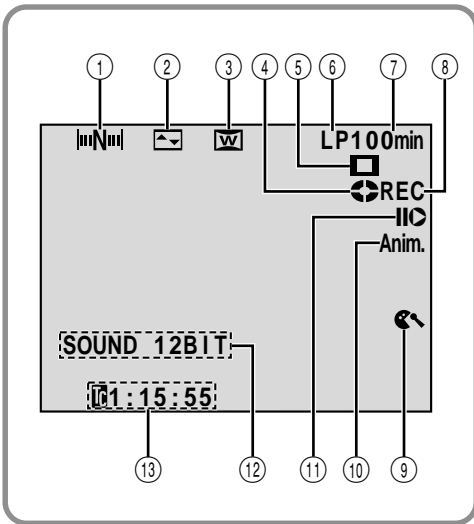

- ① Appears when "NAVIGATION" is set to "ON". (☞ pg. 42)
- ② Displays the selected Fade/Wipe effect. (☞ pg. 36, 37)
- ③ Appears when in the Squeeze or Cinema mode. (☞ pg. 30)
- ④ Rotates while the tape is running. (☞ pg. 18)
- ⑤ Appears while the captured image is being stored as a thumbnail image in the memory card. (☞ pg. 42)
- ⑥ Displays the recording mode (SP or LP). (☞ pg. 15)
- ⑦ Displays the tape remaining time. (☞ pg. 18)
- ⑧ • "REC" appears during recording.
• "PAUSE" appears during Record-Standby mode. (☞ pg. 18)
- ⑨ Appears when the wind cut mode is engaged to cut down on noise created by wind. (☞ pg. 30)
- ⑩ 5S/Anim.: Displays the 5 second recording mode or Animation recording mode. (☞ pg. 29, 35)
- ⑪ Appears when the Insert Editing (▶) or Insert Editing Pause (⏸) mode is engaged. (☞ pg. 71)
- ⑫ Displays the sound mode for approx. 5 seconds after turning on the camcorder. (☞ pg. 29)
- ⑬ Displays the Time Code. (☞ pg. 23, 31)

LCD Monitor/Viewfinder Indications During Memory Card Recording Only

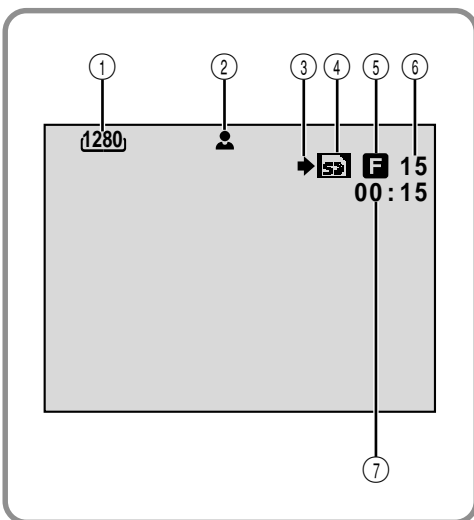

- ① Displays the image size. (☞ pg. 16, 46)
- ② Blinks while the focus is being adjusted and stops blinking when the focus is locked. (☞ pg. 21)
- ③ Appears and blinks during shooting. (☞ pg. 21)
- ④ • Appears during shooting.
• Blinks in white when a memory card is not loaded. (☞ pg. 21)
• Blinks in yellow while the camcorder is reading the data on the memory card such as titles/frames, NAVIGATION thumbnail images, Digital Sound Effects, video clips, still images, etc.
- ⑤ Displays the picture quality. There are 2 modes available: F (Fine) and S (Standard) (in order of quality). (☞ pg. 16)
- ⑥ • Displays the remaining number of shots that can be stored. (☞ pg. 21)
• Displays the remaining number of storable thumbnail images when it reaches 10 or less. (☞ pg. 42, 43)
• Displays the memory card remaining time for E-Mail Clip Recording. (☞ pg. 46)
- ⑦ Displays the E-Mail Clip Recording time. (☞ pg. 46)

LCD Monitor/Viewfinder Indications During Both Tape And Memory Card Recording

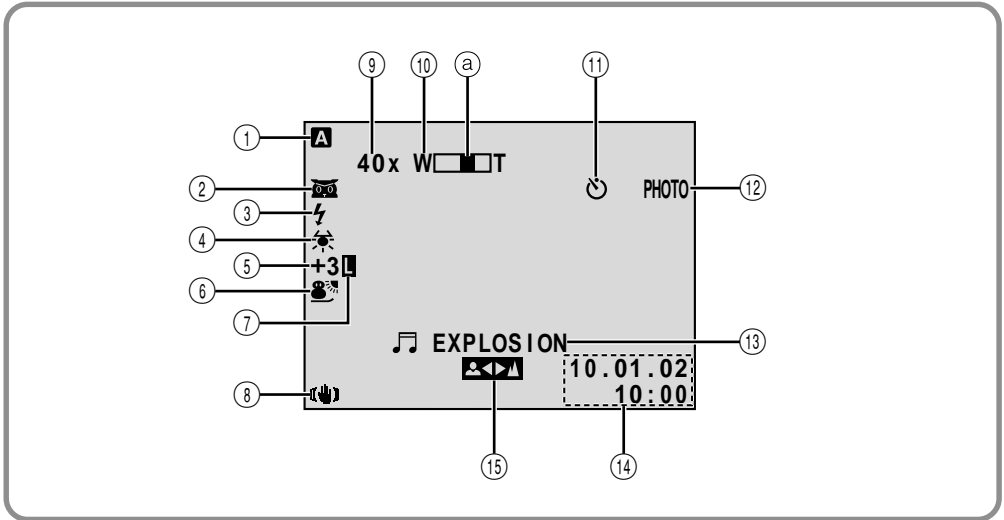

- ① Appears when the Power Switch is set to "A". (☞ pg. 14)
- ② Appears when Night-Scope is engaged. (☞ pg. 38)
- ③ Appears when the optional flash attached to the info-shoe is ready.
- ④ Appears when the white balance is adjusted. (☞ pg. 41)
- ⑤ • "±": Appears when the exposure is adjusted. (☞ pg. 40)
 • : Appears when backlight compensation is used. (☞ pg. 40)
- ⑥ Displays the selected Programme AE with special effects. (☞ pg. 38)
- ⑦ Appears when the iris is locked. (☞ pg. 40)
- ⑧ Appears when Digital Image Stabiliser ("DIS") is engaged. (☞ pg. 29)
- ⑨ Approximate zoom ratio: Appears during zooming. (☞ pg. 22)
- ⑩ Appears during zooming.
 a Zoom level indicator (☞ pg. 22)
- ⑪ Appears during Self-Timer recording. (☞ pg. 34)
- ⑫ Appears when taking a Snapshot. (☞ pg. 20, 21)
- ⑬ • Displays the selected Digital Sound Effect. (☞ pg. 45)
 • BRIGHT: Displays the brightness of the LCD monitor or the viewfinder. (☞ pg. 18)
- ⑭ Displays the date/time. (☞ pg. 11)
- ⑮ Appears when the focus is adjusted manually. (☞ pg. 24)

LCD Monitor/Viewfinder Indications During Tape Playback

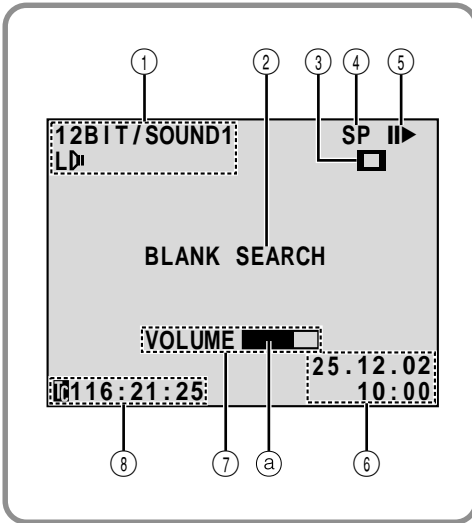





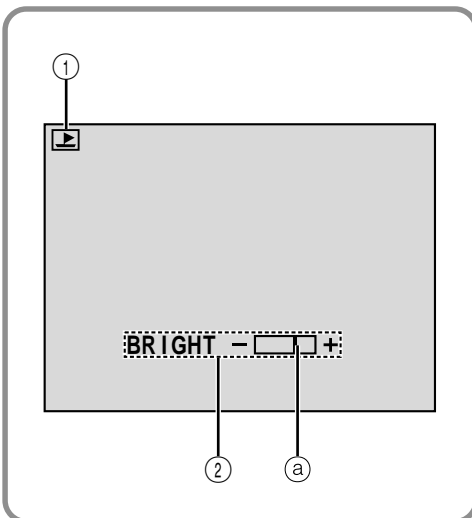

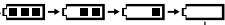

- ① Displays the sound mode. (☞ pg. 32, 33)
- ② Displays the Blank Search mode. (☞ pg. 44)
- ③ Appears while the captured image is being stored as a thumbnail image in the memory card. (☞ pg. 43)
- ④ Displays the tape speed. (☞ pg. 15)
- ⑤ Appears while a tape is running.
 - ▶ : Playback
 - ▶▶ : Fast-Forward/Shuttle search
 - ◀◀ : Rewind/Shuttle search
 - || : Pause
 - ||▶ : Forward slow-motion
 - ◀|| : Reverse slow-motion
 - : Audio Dubbing
 - ||● : Audio Dubbing Pause
- ⑥ Displays the date/time. (☞ pg. 32, 33)
- ⑦ • BRIGHT : Displays the brightness of the LCD monitor or the viewfinder. (☞ pg. 18)
- VOLUME : Displays the speaker or headphone volume. (☞ pg. 25)
 - ⓐ The level indicator moves.
- ⑧ Displays the time code. (☞ pg. 32, 33)

LCD Monitor/Viewfinder Indications During Memory Card Playback



- ① Displays the operation mode. (☞ pg. 27)
- ② Displays the brightness of the LCD monitor or the viewfinder. (☞ pg. 18)
 - ⓐ The level indicator moves.

Warning Indications

Indications	Function
	<p>Displays the battery remaining power.</p> <p>Remaining power level: high  →  →  → </p> <p>Remaining power level: exhausted </p> <p>As the battery power comes close to nil, the battery indicator  blinks. When the battery power is exhausted, power turns off automatically.</p>
	<p>Appears when no tape is loaded. (☞ pg. 12)</p>
<p>CHECK TAPE'S ERASE PROTECTION TAB</p>	<p>Appears when the erase protection tab is set to "SAVE" while the Power Switch is set to "A" or "M" and the VIDEO/MEMORY Switch is set to "VIDEO". (☞ pg. 12)</p>
<p> HEAD CLEANING REQUIRED USE CLEANING CASSETTE</p>	<p>Appears if dirt is detected on the heads during recording or playback. Use an optional cleaning cassette. (☞ pg. 90)</p>
<p> CONDENSATION OPERATION PAUSED PLEASE WAIT</p>	<p>Appears if condensation occurs. When this indication is displayed, wait more than 1 hour until condensation disappears.</p>
<p>TAPE!</p>	<p>Appears if a tape is not loaded when the Recording Start/Stop Button or SNAPSHOT Button is pressed while the Power Switch is set to "A" or "M" and the VIDEO/MEMORY Switch is set to "VIDEO".</p>
<p>TAPE END</p>	<p>Appears when the tape ends during recording or playback. (☞ pg. 19)</p>
<p>DIFFERENT FORMATTED TAPE</p>	<p>Appears if a tape in another format is loaded.</p>
<p>SET DATE/TIME!</p>	<ul style="list-style-type: none"> • Appears when the date/time is not set. (☞ pg. 11) • Appears when the built-in clock battery runs out and the previously set date/time is erased. Consult your nearest JVC dealer for replacement.
<p>LENS CAP</p>	<p>Appears for 5 seconds after power is turned on if the lens cap is attached.</p>
<p>A. DUB ERROR!</p>	<p>Appears if Audio Dubbing is attempted on a blank portion of a tape. (☞ pg. 72)</p>
<p>A. DUB ERROR! <CANNOT DUB ON A LP RECORDED TAPE> <CANNOT DUB ON A 16BIT RECORDING> <CHECK TAPE'S ERASE PROTECTION TAB> <NO SOUND FILES> <MEMORY CARD!></p>	<ul style="list-style-type: none"> • Appears if Audio Dubbing is attempted on a tape recorded in the LP mode. (☞ pg. 72) • Appears if Audio Dubbing is attempted on a tape recorded in 16-bit audio. (☞ pg. 72) • Appears if A. DUB (⊖) on the remote control is pressed when the erase protection tab is set to "SAVE". (☞ pg. 72) • Appears if there are no sound files stored in the memory card when Audio Dubbing is attempted using digital sound effects. (☞ pg. 73) • Appears if a memory card is not loaded when Audio Dubbing is attempted using digital sound effects. (☞ pg. 73)
<p>INSERT ERROR!</p>	<p>Appears if Insert Editing is attempted on a blank portion of a tape. (☞ pg. 71)</p>

CONTINUED ON NEXT PAGE

Indications	Function
INSERT ERROR! <CANNOT EDIT ON A LP RECORDED TAPE> <CHECK TAPE'S ERASE PROTECTION TAB>	<ul style="list-style-type: none"> ● Appears if Insert Editing is attempted on a tape recorded in the LP mode. (pg. 71) ● Appears if INSERT (C) on the remote control is pressed when the erase protection tab is set to "SAVE". (pg. 71)
MEMORY IS FULL	Appears when the memory card's memory is full and shooting is not possible.
COPYING FAILED	<ul style="list-style-type: none"> ● Appears if dubbing of copyguarded signals is attempted while this camcorder is being used as a recorder. ● Appears in the following cases when dubbing from a tape to a memory card: <ul style="list-style-type: none"> – when no memory card is loaded. – when the memory card's memory is full. – when the memory card is not formatted. <p>(pg. 61)</p>
MEMORY CARD!	Appears if there is no memory card loaded when you attempt to record on a memory card or access data on a memory card.
PLEASE FORMAT	Appears when there is a problem with a memory card and its memory is corrupt, or it has not been initialised. Initialise the memory card. (pg. 51)
NO IMAGES STORED	Appears if there are no image files stored on the memory card when you attempt memory card playback.
NO E-MAIL CLIP STORED	Appears if there are no video clip files stored on the memory card when you attempt memory card playback. (pg. 46)
NO SOUND FILES	Appears if there are no sound files stored on the memory card when you attempt to use digital sound effects. (pg. 45)
NO TITLE FILES	<ul style="list-style-type: none"> ● Appears if there are no title/frame files stored on the memory card when you attempt to use titles/frames. ● Appears when you attempt to use titles/frames during tape playback.
CARD ERROR!	Appears when the camcorder does not recognize the loaded memory card. Remove the memory card once and insert it again. Repeat these procedures until no indication appears. If the indication still appears, the memory card is corrupted.
UNSUPPORTED FILES	Appears when a file in a format other than MP3 is selected.
CHECK CARD'S WRITE PROTECTION SWITCH	<ul style="list-style-type: none"> ● Appears when you attempt to record on a copy-protected SD Memory Card. ● Appears when you attempt Memory Card menu operation with a copy-protected SD Memory Card loaded.
E01, E02 or E06 UNIT IN SAFEGUARD MODE REMOVE AND REATTACH BATTERY	The error indications (E01, E02 or E06) show what type of malfunction has occurred. When an error indication appears, the camcorder turns off automatically. Remove the power supply (battery, etc.) and wait a few minutes for the indication to clear. When it does, you can resume using the camcorder. If the indication remains, consult your nearest JVC dealer.
E03 or E04 UNIT IN SAFEGUARD MODE EJECT AND REINSERT TAPE	The error indications (E03 or E04) show what type of malfunction has occurred. When an error indication appears, the camcorder turns off automatically. Eject the cassette once and re-insert it, then check if the indication clears. When it does, you can resume using the camcorder. If the indication remains, consult your nearest JVC dealer.

General Battery Precautions

If the remote control is not functioning even if it is being operated correctly, the batteries are exhausted. Replace them with fresh ones.

Use only the following batteries: AAA (R03) size x 2

Please make note of the following rules for battery use. When misused, the batteries can leak or explode.

1. When replacing batteries, refer to page 62.
2. **Do not** use any different size of batteries from those specified.
3. Be sure to install batteries in the correct direction.
4. **Do not** use rechargeable batteries.
5. **Do not** expose the batteries to excessive heat as they can leak or explode.
6. **Do not** dispose of the batteries in a fire.
7. Remove the batteries from the unit if it is to be stored for an extended period to avoid battery leakage which can cause malfunctions.
8. **Do not** recharge the provided batteries.

Battery Packs

The supplied battery pack is a lithium-ion battery. Before using the supplied battery pack or an optional battery pack, be sure to read the following cautions:

1. **To avoid hazards . . .**
 - ... **do not** burn.
 - ... **do not** short-circuit the terminals. When transporting, make sure the provided battery cap is attached to the battery. If the battery cap is misplaced, carry the battery in a plastic bag.
 - ... **do not** modify or disassemble.
 - ... **do not** expose the battery to temperatures exceeding 60°C, as this may cause the battery to overheat, explode or catch fire.
 - ... use only specified chargers.

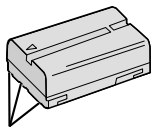

Terminals

2. **To prevent damage and prolong service life . . .**
 - ... **do not** subject to unnecessary shock.
 - ... charge in an environment where temperatures are within the tolerances shown in the chart below. This is a chemical reaction type battery—cooler temperatures impede chemical reaction, while warmer temperatures can prevent complete charging.
 - ... store in a cool, dry place. Extended exposure to high temperatures will increase natural discharge and shorten service life.
 - ... fully charge and then fully discharge the battery every 6 months when storing the battery pack over a long period time.
 - ... remove from charger or powered unit when not in use, as some machines use current even when switched off.

NOTES:

- It is normal for the battery pack to be warm after charging, or after use.
- Temperature Range Specifications**
- | | |
|-----------------|---------------|
| Charging | 10°C to 35°C |
| Operation | 0°C to 40°C |
| Storage | -10°C to 30°C |
- Recharging time is based on room temperature of 20°C.
 - The lower the temperature, the longer recharging takes.

Cassettes

To properly use and store your cassettes, be sure to read the following cautions:

1. **During use . . .**
 - ... make sure the cassette bears the Mini DV mark.
 - ... be aware that recording onto prerecorded tapes automatically erases the previously recorded video and audio signals.
 - ... make sure the cassette is positioned properly when inserting.
 - ... do not load and unload the cassette repeatedly without allowing the tape to run at all. This slackens the tape and can result in damage.
 - ... do not open the front tape cover. This exposes the tape to fingerprints and dust.
2. **Store cassettes . . .**
 - ... away from heaters or other heat sources.
 - ... out of direct sunlight.
 - ... where they won't be subject to unnecessary shock or vibration.
 - ... where they won't be exposed to strong magnetic fields (such as those generated by motors, transformers or magnets).
 - ... vertically, in their original cases.

Memory Cards

To properly use and store your memory cards, be sure to read the following cautions:

1. **During use . . .**
 - ... make sure the memory card bears the SD or MultiMediaCard mark.
 - ... make sure the memory card is positioned properly when inserting.
2. **While the memory card is being accessed (during recording, playback, deletion, initialisation, etc.) . . .**
 - ... never unload the memory card and never turn off the camcorder.
3. **Store memory cards . . .**
 - ... away from heaters or other heat sources.
 - ... out of direct sunlight.
 - ... where they won't be subject to unnecessary shock or vibration.
 - ... where they won't be exposed to strong magnetic fields (such as those generated by motors, transformers or magnets).

LCD Monitor

1. **To prevent damage to the LCD monitor, DO NOT . . .**
 - ... push it strongly or apply any shocks.
 - ... place the camcorder with the LCD monitor on the bottom.
2. **To prolong service life . . .**
 - ... avoid rubbing it with coarse cloth.
3. **Be aware of the following phenomena for LCD monitor use.**

These are not malfunctions:

 - While using the camcorder, the surface around the LCD monitor and/or the back of the LCD monitor may heat up.
 - If you leave power on for a long time, the surface around the LCD monitor becomes hot.

Main Unit

1. **For safety, DO NOT . . .**
 - ... open the camcorder's chassis.
 - ... disassemble or modify the unit.
 - ... short-circuit the terminals of the battery pack. Keep it away from metallic objects when not in use.
 - ... allow inflammables, water or metallic objects to enter the unit.
 - ... remove the battery pack or disconnect the power supply while the power is on.
 - ... leave the battery pack attached when the camcorder is not in use.
2. **Avoid using the unit . . .**
 - ... in places subject to excessive humidity or dust.
 - ... in places subject to soot or steam such as near a cooking stove.

- ... in places subject to excessive shock or vibration.
- ... near a television set.
- ... near appliances generating strong magnetic or electric fields (speakers, broadcasting antennas, etc.).
- ... in places subject to extremely high (over 40°C) or extremely low (under 0°C) temperatures.

3. **DO NOT leave the unit . . .**
 - ... in places of over 50°C.
 - ... in places where humidity is extremely low (below 35%) or extremely high (above 80%).
 - ... in direct sunlight.
 - ... in a closed car in summer.
 - ... near a heater.
4. **To protect the unit, DO NOT . . .**
 - ... allow it to become wet.
 - ... drop the unit or strike it against hard objects.
 - ... subject it to shock or excessive vibration during transportation.
 - ... keep the lens directed at extremely bright objects for long periods.
 - ... expose the lens to direct sunlight.
 - ... carry it by holding the LCD monitor or the viewfinder.
 - ... swing it excessively when using the shoulder strap or the grip.

5. Dirty heads can cause the following problems:

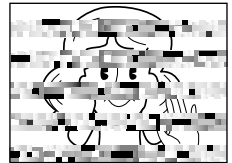

- No picture during playback.
- Blocks of noise appear during playback.
- During recording or playback, the Head Clog Warning indicator "X" appears.
- Recording cannot be performed properly.

In such cases, use an optional cleaning cassette. Insert it and play back. If the cassette is used more than once consecutively, damage to the video heads may result. After the camcorder plays back for about 20 seconds, it stops automatically. Also refer to the cleaning cassette's instructions. If, after using the cleaning cassette, the problems still exist, consult your nearest JVC dealer. Mechanical moving parts used to move the video heads and video tape tend to become dirty and worn out over time. In order to maintain a clear picture at all times, periodic check-ups are recommended after using the unit for about 1,000 hours. For periodic check-ups please consult your nearest JVC dealer.

How to handle a CD-ROM

- Take care not to soil or scratch the mirror surface (opposite to the printed surface). Do not write anything or put a sticker on either the front or back surface. If the CD-ROM gets dirty, gently wipe it with a soft cloth outward from the centre hole using a circular motion.
- Do not use conventional disc cleaners or cleaning spray.
- Do not bend the CD-ROM or touch its mirror surface.
- Do not store your CD-ROM in a dusty, hot or humid environment. Keep it away from direct sunlight.

































































About moisture condensation . . .















































- You have observed that pouring a cold liquid into a glass will cause drops of water to form on the glass' outer surface. This same phenomenon occurs on the head drum of a camcorder when it is moved from a cool place to a warm place, after heating a cold room, under extremely humid conditions or in a place directly subjected to the cool air from an air conditioner.
- Moisture on the head drum can cause severe damage to the video tape, and can lead to internal damage to the camcorder itself.

Serious malfunctioning

If malfunctioning occurs, stop using the unit immediately and consult your local JVC dealer.



The camcorder is a microcomputer-controlled device. External noise and interference (from a TV, a radio, etc.) might prevent it from functioning properly. In such cases, first disconnect its power supply unit (battery pack, AC Power Adapter/ Battery Charger, etc.) and wait a few minutes and then re-connect it and proceed as usual from the beginning.

- A**
- AC Power Adapter/Charger  pg. 8, 9
 - Analogue Input  pg. 32, 59
 - Animation  pg. 29
 - Audio Dubbing  pg. 72
 - Auto Date  pg. 31
 - Auto Focus  pg. 24
 - Auto Playback  pg. 26
 - Auto Shut off  pg. 19, 21, 25
- B**
- Backlight Compensation  pg. 40
 - Battery Low  pg. 87
 - Battery Pack  pg. 8, 9, 89
 - Beep  pg. 30
 - Blank Search  pg. 44
 - Brighten The LCD Monitor  pg. 18
- C**
- Channels (Left/Right)  pg. 33
 - Charge The Battery Pack  pg. 8
 - Cinema  pg. 30
 - Classic Film  pg. 39
 - Clean The Camcorder  pg. 80
 - Connections  pg. 9, 54 – 60, 67
- D**
- Darken The LCD Monitor  pg. 18
 - Date/Time Display  pg. 31 – 33
 - Date/Time Settings  pg. 11
 - Deleting Files  pg. 50
 - Demonstration Mode  pg. 7, 31
 - Digital Sound Effect  pg. 45
 - Digital Zoom  pg. 22, 29
 - DIS (Digital Image Stabiliser)  pg. 29
 - Dioptrre Adjustment  pg. 10
 - DPOF (Digital Print Order Format)  pg. 52
 - Dubbing  pg. 58 – 61
- E**
- E-Mail Clip Recording  pg. 46
 - Erase Protection  pg. 12
 - Exposure Control  pg. 40
- F**
- Fade-In/Out  pg. 36, 37
 - Fast-Forward The Tape  pg. 25
 - 5-second recording mode  pg. 35
 - Frame-By-Frame Playback  pg. 25, 64
- G**
- Gain Up  pg. 29
 - Grip Adjustment  pg. 10
- I**
- Icons  pg. 29 – 32
 - Index Playback  pg. 27
 - Index Screen  pg. 27
 - Initialise A Memory Card  pg. 51
 - Insert Editing  pg. 71
 - Interface Shooting  pg. 19
 - Iris  pg. 40
 - Iris Lock  pg. 40
- J**
- Journalistic Shooting  pg. 19
- L**
- LCD monitor/Viewfinder Indications  pg. 84 – 88
 - Load A Tape  pg. 12
- M**
- Manual Focus  pg. 24
 - Memory Card  pg. 13, 90
 - Menu Screen, CAMERA  pg. 29
 - Menu Screen, DISPLAY  pg. 31, 32
 - Menu Screen, DSC  pg. 16, 31
 - Menu Screen, MANUAL  pg. 29, 30
 - Menu Screen, SYSTEM  pg. 30, 32
 - Menu Screen, VIDEO  pg. 32
 - Monotone  pg. 39
 - Motor Drive Mode  pg. 20
 - MultiMediaCard  pg. 13, 90
- N**
- NAVIGATION function  pg. 42
 - Night-Scope  pg. 38

- P**
- Picture Quality/Image Size  pg. 16
 - Picture Wipe/Dissolve  pg. 68
 - Playback Special Effects  pg. 65
 - Playback Zoom  pg. 64
 - Power Switch Position  pg. 14
 - Programme AE With Special Effects  pg. 38, 39
 - Protecting Files  pg. 49
 - Provided Accessories  pg. 6
- R**
- Random Assemble Editing  pg. 66 – 70
 - Record-Standby  pg. 18
 - Recording Mode  pg. 15
 - Remote Control  pg. 62
 - Reset  pg. 31
 - Rewind The Tape  pg. 25
- S**
- SD Memory Card  pg. 13, 90
 - Self-Recording  pg. 19
 - Self-Timer  pg. 34
 - Sepia  pg. 39
 - Set Remote Control/VCR Code  pg. 66
 - Shuttle Search  pg. 25
 - Shutter Speed  pg. 39
 - Slow-Motion Playback  pg. 25, 64
 - Snapshot  pg. 20, 21
 - Snapshot Mode  pg. 20
 - Snow  pg. 39
 - Sound Mode  pg. 29, 32, 33
 - Speaker Volume  pg. 25
 - Specifications  pg. 94, 95
 - Sports  pg. 39
 - Spotlight  pg. 39
 - Squeeze  pg. 30
 - Still Playback  pg. 25
 - Strobe  pg. 39
- T**
- Tally  pg. 30
 - Tele Macro  pg. 30
 - Time Code  pg. 23, 31 – 33
 - Title Impose  pg. 48
 - Tripod Mounting  pg. 10
 - Twilight  pg. 39
- U**
- Unload A Tape  pg. 12
- V**
- VIDEO/MEMORY Switch Position  pg. 14
- W**
- WebCam  pg. 57
 - White Balance  pg. 41
 - Wide Mode  pg. 30
 - Wind Cut  pg. 30
 - Wipe In/Out  pg. 36, 37
- Z**
- Zooming  pg. 22

Camcorder

General

Power supply	: DC 6.3 V  (Using AC Power Adapter/Charger) DC 7.2 V  (Using battery pack)
Power consumption	
LCD monitor off, viewfinder on	: Approx. 4.3 W
LCD monitor on, viewfinder off	: Approx. 5.4 W
Dimensions (W x H x D)	: 76 mm x 90 mm x 194 mm (with the LCD monitor closed and the viewfinder pushed back in, without the lens hood)
Weight	: Approx. 660 g (without cassette, memory card and battery) Approx. 740 g (incl. cassette, memory card and battery)
Operating temperature	: 0°C to 40°C
Operating humidity	: 35% to 80%
Storage temperature	: -20°C to 50°C
Pickup	: 1/3.6" CCD
Lens	: F 1.2, f = 4.5 mm to 45 mm, 10:1 power zoom lens
Filter diameter	: ø52 mm
LCD monitor	: 3.5" diagonally measured, LCD panel/TFT active matrix system
Viewfinder	: Electronic viewfinder with 0.44" colour LCD
Speaker	: Monaural

Digital Video Camera

Format	: DV format (SD mode)
Signal format	: PAL standard
Recording/Playback format	: Video: Digital component recording Audio: PCM digital recording, 32 kHz 4-channel (12-bit), 48 kHz 2-channel (16-bit)
Cassette	: Mini DV cassette
Tape speed	: SP: 18.8 mm/s LP: 12.5 mm/s
Maximum recording time (using 80 min. cassette)	: SP: 80 min. LP: 120 min.

Digital Still Camera Function

Storage media	: SD Memory Card/MultiMediaCard
Compression system	: Still image : JPEG (compatible) Moving image : MPEG4 (compatible)
File size	: Still image : 4 modes (1600 x 1200 pixels, 1280 x 960 pixels, 1024 x 768 pixels, 640 x 480 pixels) Moving image : 2 modes (240 x 176 pixels, 160 x 120 pixels)
Picture quality	: 2 modes (FINE/STANDARD)
Approximate number of storable images (with the provided memory card [8 MB])	
FINE	: 32 (640 x 480 pixels), 14 (1024 x 768 pixels), 9 (1280 x 960 pixels), 6 (1600 x 1200 pixels)
STANDARD	: 110 (640 x 480 pixels), 46 (1024 x 768 pixels), 30 (1280 x 960 pixels), 20 (1600 x 1200 pixels)

For other memory cards,  pg. 17.

Connectors

AV	
Video output	: 1 V (p-p), 75 Ω , analogue
Video input	: 0.5 V (p-p) – 2.0 V (p-p), 75 Ω , analogue
Audio output	: 300 mV (rms), 1 k Ω , analogue, stereo
Audio input	: 300 mV (rms), 50 k Ω , analogue, stereo
DV	
Input/output	: 4-pin, IEEE 1394 compliant
PHONE	
Headphone output	: \varnothing 3.5 mm, stereo
PRINTER	: For an optional video printer equipped with a PRINT DATA connector

AC Power Adapter/Charger AA-V40EA, AA-V40A, AA-V40SH or AA-V40ED

Power requirement	: AC 110 V to 240 V \sim , 50 Hz/60 Hz
Power consumption	: 23 W
Output	
Charge	: DC 7.2 V $\overline{\text{---}}$, 1.2 A
VTR	: DC 6.3 V $\overline{\text{---}}$, 1.8 A
Dimensions (W x H x D)	: 68 mm x 38 mm x 110 mm
Weight	
AA-V40EA	: Approx. 270 g
AA-V40A/SH/ED	: Approx. 260 g

Jack Box CU-V504U

General

Dimensions (W x H x D)	: 37.5 mm x 18.5 mm x 55 mm
Weight	: Approx. 30 g

Connectors

USB	: TYPE B
S-VIDEO	
Output	: Y: 1 V (p-p), 75 Ω , analogue C: 0.29 V (p-p), 75 Ω , analogue
Input	: Y: 0.8 V (p-p) – 1.2 V (p-p), 75 Ω , analogue C: 0.2 V (p-p) – 0.4 V (p-p), 75 Ω , analogue
EDIT	: \varnothing 3.5 mm, 2-pole

Specifications shown are for SP mode unless otherwise indicated. E & O.E. Design and specifications subject to change without notice.

