

FURUNO

OPERATOR'S MANUAL

AUTOPILOT

MODEL NAVpilot-511

NAV*pilot*



FURUNO ELECTRIC CO., LTD.
NISHINOMIYA, JAPAN

© **FURUNO ELECTRIC CO., LTD.**

9-52 Ashihara-cho,
Nishinomiya, Japan

Telephone : 0798-65-2111
fax : 0798-65-4200

Your Local Agent/Dealer

All rights reserved.

Printed in Japan

FIRST EDITION : JAN. 2004

PUB.No. OME-72501

(HIMA) NAVPILOT-511



* 0 0 0 1 4 8 6 0 3 0 0 *



* O M E 7 2 5 0 1 A 0 0 *



SAFETY INSTRUCTIONS



WARNING



**ELECTRICAL
SHOCK
HAZARD**

Do not open the equipment unless you are well familiar with electrical circuits.

Only qualified personnel should work inside the equipment.

Do not set the course changing speed too high.

The boat will be turned too sharply at the course change, which could create a very dangerous situation.

Do not use the autopilot in the following situation:

- Harbor entrance or narrow channel
- Where vessels change course often, such as a cape or small island

Observe the following cautions when using the autopilot:

- Maintain a vigilant watch
- Watch for drifting of vessel

In an emergency, manually steer the vessel.

The autopilot cannot avoid vessels, etc. automatically.

Do not use the SIMULATION mode on the boat.

The rudder may move. This is special-purpose mode for technicians.



WARNING

Do not use the ORBIT mode in rough sea.

Because the boat turns a 360-degree circle around the waypoint a large wave or strong wind can cause the boat to capsize.

For the figure eight mode, confirm that no objection is in the general vicinity of the waypoint.

The distance from the waypoint to the turning point depends on boat's speed.

Do not use the SIMULATION mode on the boat.

The rudder may move. This is special-purpose mode for technicians.



CAUTION

In case of power failure turn off the autopilot or manually steer the vessel.

Leaving the equipment in the AUTO or NAV mode during power failure will cause wear on the rudder mechanism.

Use the correct fuse.

Use of a wrong fuse can cause fire or damage the equipment.

WARNING LABEL

A warning label is attached to the processor unit. Do not remove the label. If the label is missing or damaged, contact your dealer about replacement.

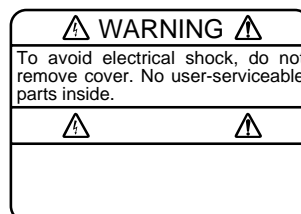

Name: Warning Label (1)
Type: 86-003-1011
Code No.: 100-236-231

TABLE OF CONTENTS

FORWORD	iv
SYSTEM CONFIGURATION	v
1. PRINCIPLE OF THE AUTOPILOT	1-1
Principle of Autopilot.....	1-1
Principle of Operation.....	1-2
2. BASIC OPERATION	2-1
2.1 Operating Controls.....	2-1
2.2 Turning On/Off.....	2-2
2.3 Adjusting Brilliance and Contrast.....	2-3
2.4 Displays.....	2-4
2.4.1 Choosing the display mode.....	2-4
2.4.2 Selecting the data shown on Data Display.....	2-5
3. STEERING MODES	3-1
3.1 STBY Mode.....	3-1
3.2 AUTO Mode.....	3-2
3.2.1 Using the AUTO mode.....	3-2
3.2.2 ADVANCED AUTO mode.....	3-3
3.3 NAV Mode.....	3-4
3.3.1 Starting the NAV mode.....	3-4
3.3.2 Selecting sailing method of NAV mode.....	3-5
3.3.3 Switching waypoint.....	3-6
3.3.4 Selecting the boat's steering behavior after arriving at your destination waypoint.....	3-7
3.4 TURN Mode.....	3-8
3.5 REMOTE Mode.....	3-16
3.6 DODGE Mode.....	3-20
3.6.1 Dodging in STBY mode.....	3-20
3.6.2 Dodging in AUTO or NAV mode.....	3-21
4. MENU OPERATION	4-1
4.1 STBY Mode Menu.....	4-1
4.1.1 Setting parameters.....	4-2
4.1.2 Setting other menu item.....	4-10

5. ALARMS	5-1
5.1 ALARM SETUP Menu.....	5-1
5.1.1 Selecting the alarm buzzer.....	5-2
5.1.2 Selecting the beep pattern	5-2
5.1.3 Setting the watch alarm	5-3
5.1.4 Setting the heading deviation alarm	5-3
5.1.5 Setting the cross-track error limit.....	5-4
5.1.6 Setting the speed alarm	5-5
5.1.7 Setting the depth alarm.....	5-6
5.1.8 Setting the temperature alarm.....	5-7
5.1.9 Setting the trip distance alarm.....	5-7
5.1.10 Clearing the trip distance	5-8
5.2 Alarm Information	5-9
6. MAINTENANCE & TROUBLESHOOTING	6-1
6.1 Preventive Maintenance	6-1
6.2 Replacement of Fuse.....	6-2
6.3 Diagnostics	6-2
6.4 Clearing Memories.....	6-6
6.5 Error Messages	6-7
MENU TREE	MN-1
SPECIFICATIONS	SP-1
INDEX	IN-1

FOREWORD

A Word to the Owner of the NAVpilot-511

Congratulations on your choice of the FURUNO NAVpilot-511 AUTOPILOT.

For over 50 years FURUNO Electric Company has enjoyed an enviable reputation for innovative and dependable marine electronics equipment. This dedication to excellence is furthered by our extensive global network of agents and dealers.

Your autopilot is designed and constructed to meet the rigorous demands of the marine environment. However, no machine can perform its intended function unless installed, operated and maintained properly. Please carefully read and follow the recommended procedures for operation and maintenance.

We would appreciate hearing from you, the end-user, about whether we are achieving our purposes.

Thank you for considering and purchasing FURUNO equipment.

Features

- Self-learning program to continuously improve the steering parameters for safe and expeditious navigation
- Two steering modes – AUTO (Heading Control System) and NAV (Track Control System)
- Dodging from the control unit or remote controller
- Available for solenoid drive and reversible hydraulic
- Max. six control units may be connected (using two ports of the processor unit)
- Menu operation for simplified control
- Display modes: Autopilot/Track control modes with rudder angle, L/L, Highway, Two customized displays, compass rose

SYSTEM CONFIGURATION

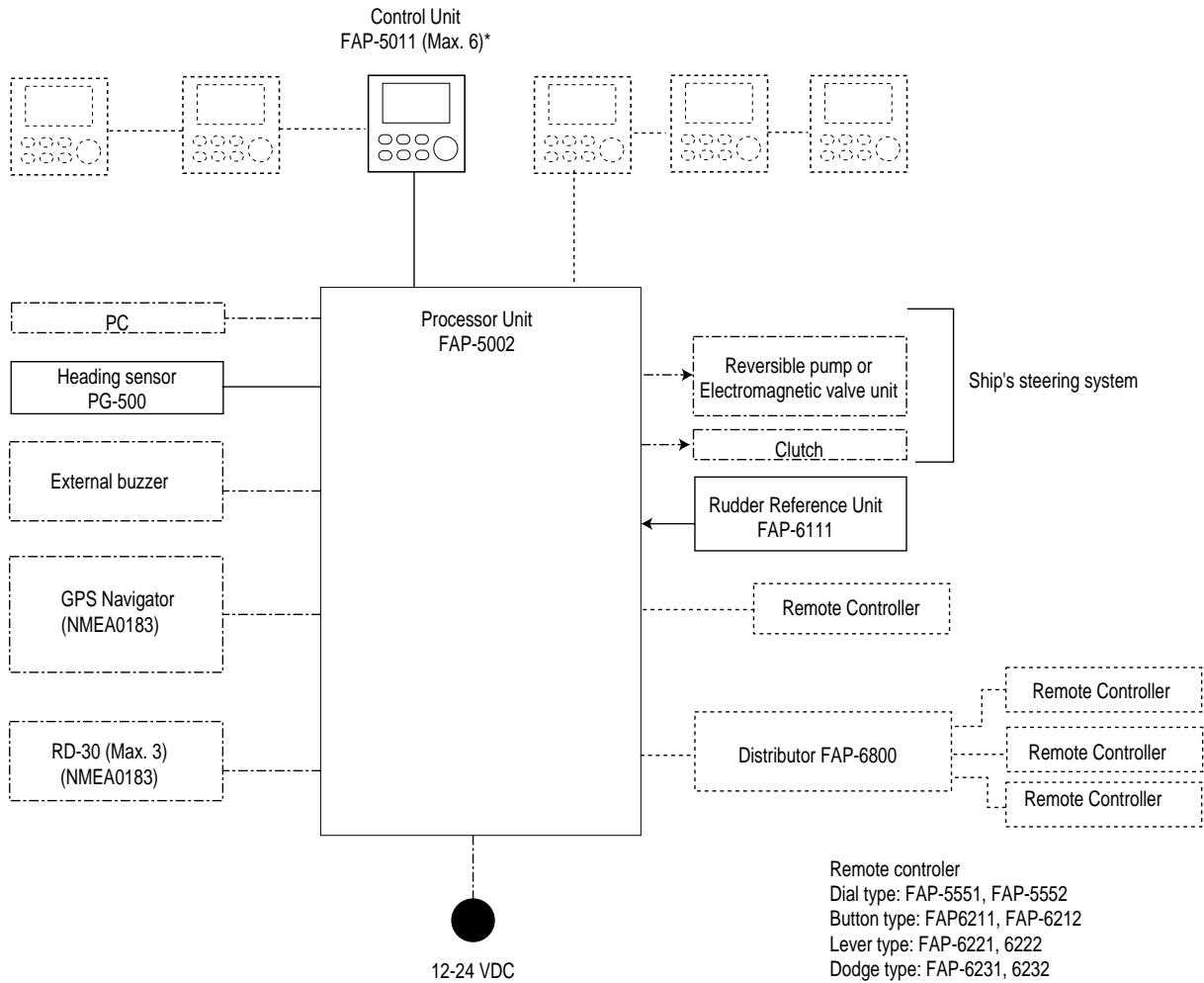

*: Any combination of FAP-5001 and FAP-5011 is available, provided the program no. are;
 FAP-5002: 6454002-02.01 and after
 FAP-5001: 6454001-02.01 and after

———— : Standard supply
 - - - - - : Option
 - · - · - : User supply

System configuration of NAVpilot-500

This page is intentionally left blank.

1. PRINCIPLE OF THE AUTOPILOT

Principle of Autopilot

An autopilot is an automatic device for steering a vessel and maintaining its heading in an intended direction. Boat and ship operators can really appreciate the advantages of the autopilot – It steers the boat for you so that you are free to carry out navigational checks, trim adjustments, etc. or to simply relax and enjoy the ride.

The NAVpilot-511 autopilot utilizes a proportional rate system to steer the boat. This system is similar to the highly accurate and reliable systems used on aircraft, missiles and space vehicles. The proportional rate autopilot provides the necessary course correction to the steering system relative to the speed and amount that the boat moves off course.

Dead band is the area (in degrees) that an autopilot is allowed to drift before correcting the vessel's course. Since your NAVpilot-511's advanced processor does not utilize a dead-band, it will not drift or wander, and will steer the boat reliably and accurately, taking action if even a minute course error occurs.

Because wandering is eliminated, the proportional rate autopilot uses less power and lowers wear and tear on the steering system. Course correction is smooth, and consistent, and the boat will not jerk back and forth at any speed.

Principle of Operation

In the AUTO modes, the heading information from a heading sensor is continuously compared with the course that is set on the autopilot's controller. (in the NAV mode, the course to the waypoint is received from a plotter connected to the NAVpilot-511). With the boat on course, these two signals are equal.

If the boat drifts off course, the difference between the primary heading and the set course will change proportionally and there will be an imbalance at a comparator. The comparator's output will then move up or down depending on whether the course error is to the left or right of the set course.

The rudder will continue to turn the vessel until a balanced condition is obtained at the comparator, at which point the drive to the rudder stops.

The rudder position is determined by a rudder reference unit and continuously monitored by the processor unit.

2. BASIC OPERATION

2.1 Operating Controls

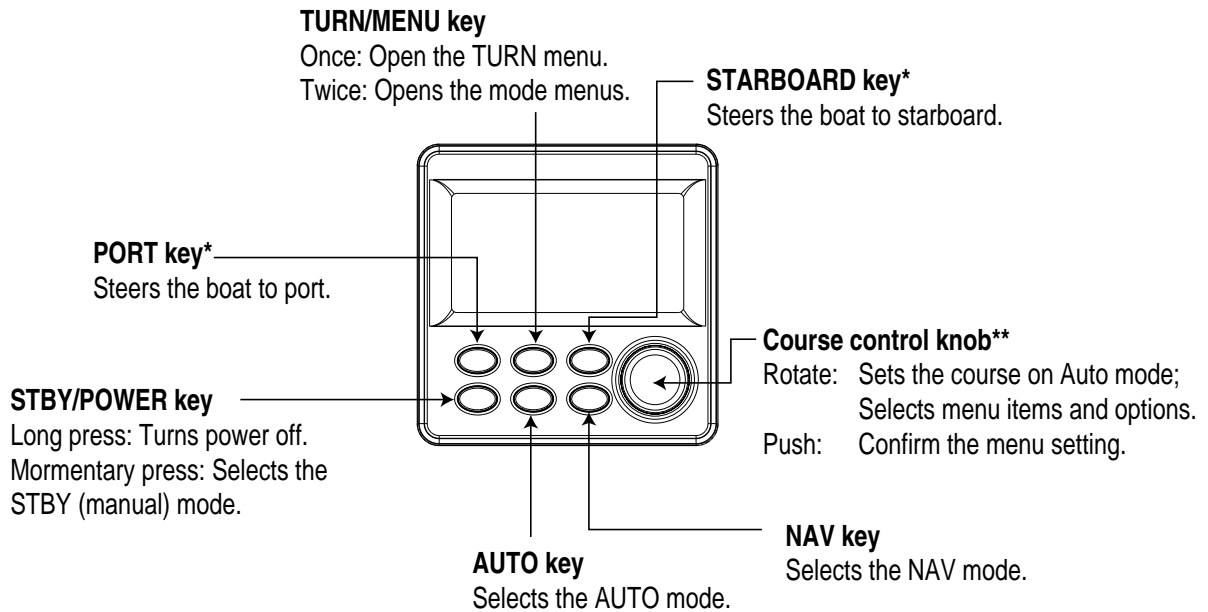

*: This knob is called as "ENTER KNOB" in the menu indications.

** : Deccribed as below in the text.

[◀]: [PORT] key

[▶]: [STBD] key

Control unit, front view

2.2 Turning On/Off

Press the [STBY/POWER] key to turn the unit on. (For PG-500, see Note 2 shown below.) A beep sounds and the equipment proceeds in the sequence shown below, showing product information and startup test results. The startup test checks the ROM, RAM, backed up data and communication between the control unit and processor unit, and also checks for the presence of heading from the sensor and rudder angle information from the rudder angle indicator. If NG appears, an appropriate message will also appear on the screen. If NG is shown, contact your dealer for advice.

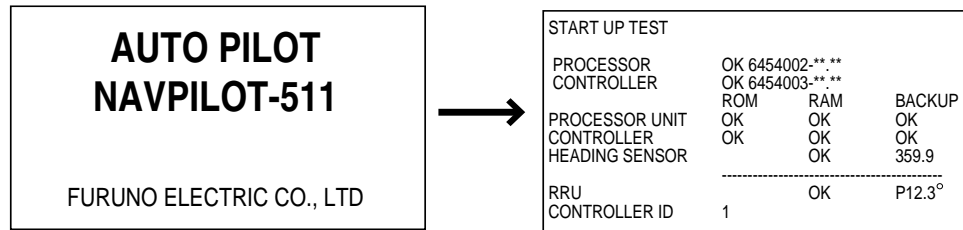

*** : Program version no.

Startup sequence

After the startup test is completed, "STBY" appears on the screen. This means that the equipment may now be operated manually.

Note 1: The first time you turn on the power, you are asked to select Normal, Installation or Simulation mode. Rotate the course control knob to select the appropriate mode, and then press it.

Note 2: When the Integrated Heading Sensor PG-500 is connected, turn on the NAVpilot-511 and wait four minutes before leaving port in order to allow time for the PG-500 heading data to stabilize.

Note 3: The example screens shown in this manual may not match the screens you see on your display. The screen you see depends on your system configuration and equipment settings.

Turning the power off

Press and hold down the [STBY/POWER] key until the screen goes blank.

2.3 Adjusting Brilliance and Contrast

The brilliance and contrast can be adjusted as below:

1. Press the [TURN/MENU] key twice to show the main menu.

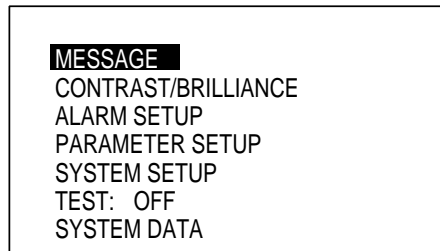

Main menu (ex. STBY mode)

2. Rotate the course control knob to choose "CONTRAST/BRILLIANCE", and then press it.

The CONTRAST/BRILLIANCE window appears.

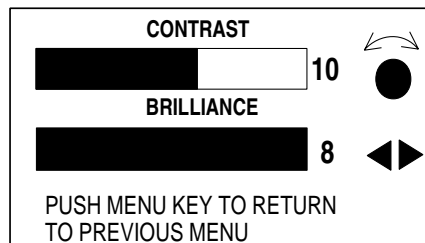

Contrast, brilliance window

3. Rotate the course control knob to adjust display contrast; clockwise to raise the contrast and counter-clockwise to lower it. (16 levels are available.)
4. Press the [PORT] or [STBD] key to adjust display brilliance, [PORT] to lower the brilliance and [STBD] to raise it. (Eight levels are available.)

To close the CONTRAST and BRILL window, press the [TURN/MENU] key twice.

2.4 Displays

2.4.1 Choosing the display mode

There are three types of displays: Normal display 1, Normal display 2, and Data display.

To choose a display mode, press a mode key (AUTO, NAV, STBY). Each time a mode key is pressed the display changes in the sequence shown below.

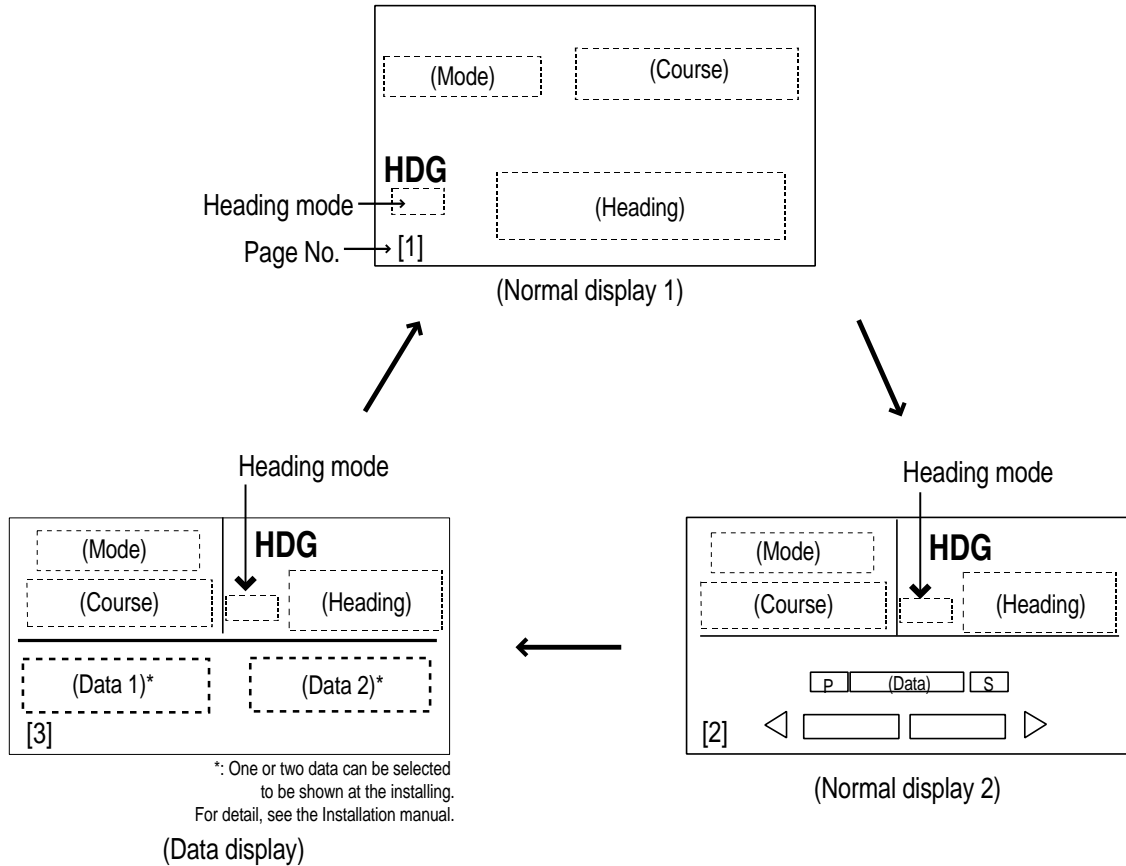

(Data display)

Displays

2.4.2 Selecting the data shown on Data Display

Data Display may be set up to suit your operating needs as below.

Selecting data

In the STBY mode, you can select which data you want to display in the columns shown in the figure below. For Normal Display 2, you may choose which data you want to show on the analog indicator.

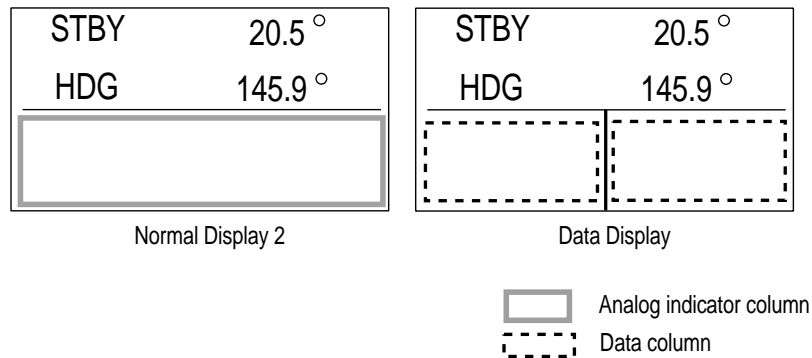

1. Press the [STBY] key to show the STBY mode.
2. Press the [STBY] key several times to show the one of screens shown above, which you want to change the data.
3. Press the course control knob.
4. For two data display, press the [PORT] or [STBD] key to select the column desired.
5. Rotate the course control knob to select the data you want to show.
Available data and analog indicators are listed on the next page.
6. Press the course control knob to finish.

2. BASIC OPERATION

Data available for Normal display 2, Data display and Graphic display

Item	Displayed data
POS	Own ship's position (L/L)
COG	Course over ground
SOG	Speed over ground
STW	Speed through water
TEMP	Water temperature
DPT	Depth
BRG	Bearing to waypoint
RNG	Range to waypoint
WPT	Waypoint position (L/L)
XTE	Cross-track error
TTG	Time-to-Go to Destination
ETA	Estimated Time of Arrival
DATE	Date
TIME	Time
WIND TRUE*	Wind direction and speed (True)
WIND RELATIV**	Wind direction and speed (Relative)
VOLT	Input/output power voltage to the processor unit
TRIP	Trip distance

*True: The Speed and direction (relative to due north)

**Relative: The direction (in relation to ship's bow) and speed of the wind as it appears to those on board, relative to the speed and direction of the boat; combination of the true wind and the wind caused by the boat's movement.

Analog indicator selection

Item	Displayed data
RUDDER ANGLE	Rudder angle
DEVIATION	Deviation of heading
RUDDER/XTE	Rudder angle will appear while in the STBY and AUTO modes, XTE will appear while in the NAV mode.
DEV./XTE	Deviation will appear in the STBY mode and AUTO modes, XTE will be shown while in the NAV mode.

3. STEERING MODES

The NAVpilot-511 system is capable of six primary steering modes: STBY (manual), AUTO, NAV, TURN, REMOTE (FU and NFU) and DODGE.

3.1 STBY Mode

After turning on the power, the equipment goes to the STBY mode. This is a manual steering mode. When sailing into or out of a harbor, steer the vessel in the STBY mode by using the ship's steering wheel (helm).

Press the [STBY] key.

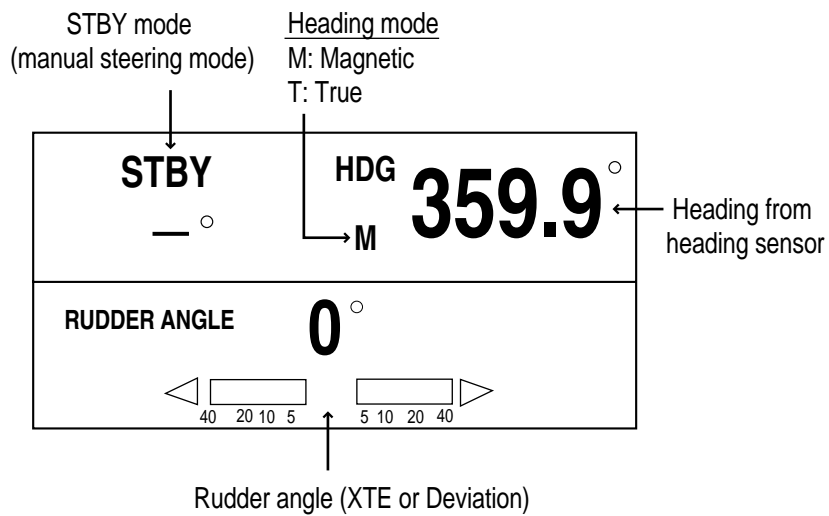

STBY mode display (Ex. Normal Display 2)

3.2 AUTO Mode

3.2.1 Using the AUTO mode

The NAVpilot-511's AUTO mode steers the boat automatically on a course set by the operator.

Note: The AUTO mode will not compensate for the effects of wind or tide, which can push you off course in the athwart ship direction. Use the AUTO mode for short, straight voyages. Otherwise switch to the NAV mode which is described on page 3-4.

1. Direct the boat to the intended course desired.
2. Press the [AUTO] key to activate the Auto mode.

Your boat will automatically maintain the current course at the moment the [AUTO] key is pressed.

Whenever the heading deviates from the set course, the NAVpilot-511 automatically adjusts the rudder to return the boat to the set course.

3. To change or readjust the course setting in the AUTO mode, simply rotate the course control knob to the desired course.
4. Press the [STBY] key to leave AUTO steering in an emergency. You can steer your boat by the helm.

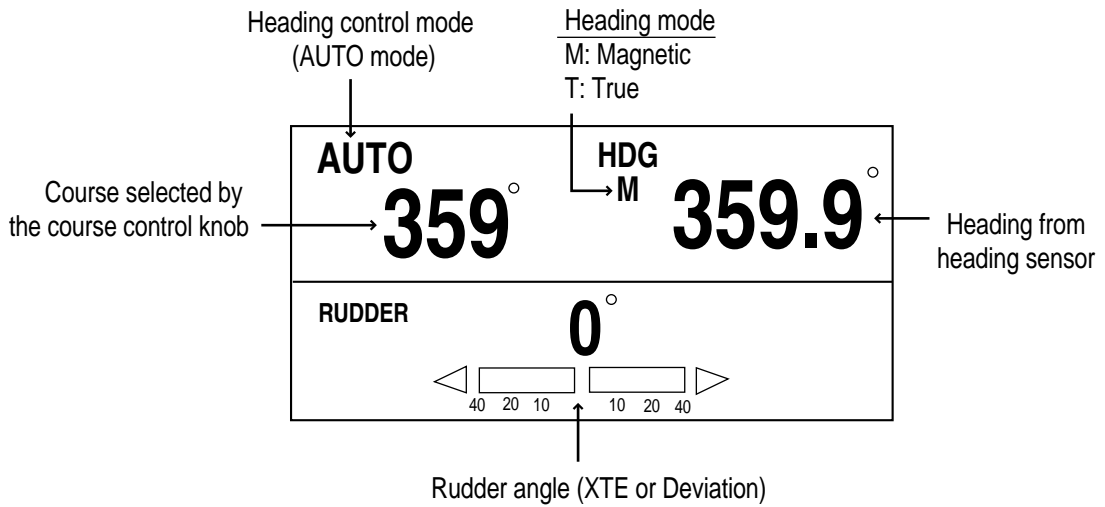

AUTO mode display (Ex. Normal Display 2)

3.2.2 ADVANCED AUTO mode

AUTO mode will maintain a set course, but your vessel's course may be shifted by the effects of current or wind. ADVANCED AUTO mode maintains a set course while compensating for the effects of wind and tide. Note that your NAVpilot-511 must be connected to a (GPS) which outputs own ship's position data (L/L) in NMEA0183 format to the NAVpilot-511.

In the ADVANCED AUTO mode, the NAVpilot-511 will calculate your course based on your present position and heading, and by setting a virtual "waypoint" in its memory to navigate towards. If either tide or wind begins to push you off course, the NAVpilot-511's processor will correct your heading accordingly. In this mode, "AUTO" appears on the display.

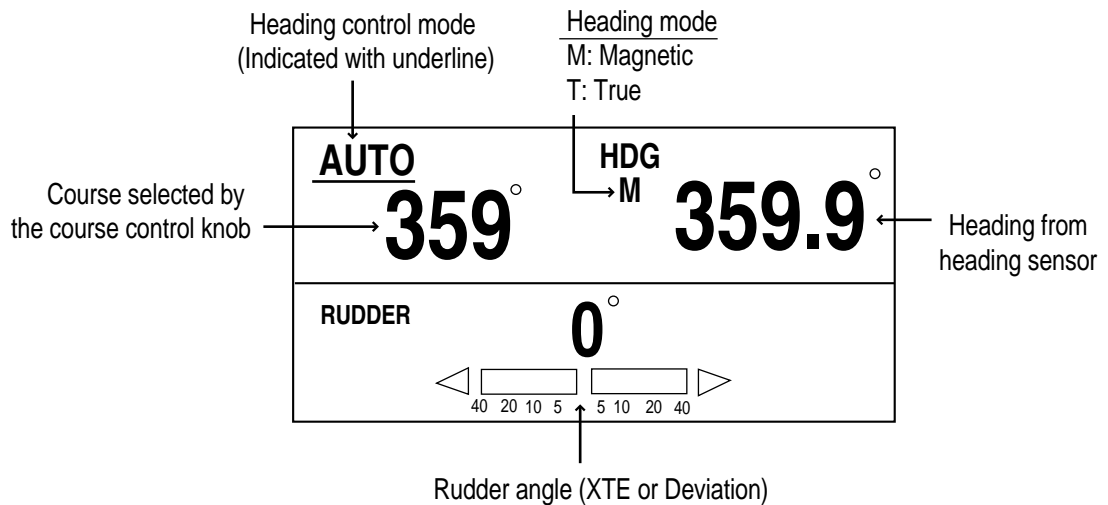

ADVANCED AUTO mode display (Ex. Normal Display 2)

Enabling the ADVANCED AUTO mode

You can select whether to use the ADVANCED AUTO mode or not as follows.

1. In the AUTO mode, press the [TURN/MENU] key twice to show the AUTO mode menu.
2. Rotate the course control knob to select "ADVANCED AUTO", and then press the course control knob to show the advanced auto options window.

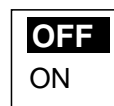

Advanced auto options window

3. Rotate the course control knob to select "ON".
When you want to finish the ADVANCED AUTO mode, select "OFF".
4. Press the course control knob to close the menu.

3.3 NAV Mode

3.3.1 Starting the NAV mode

If a destination waypoint is set on a GPS / Plotter, the NAVpilot-511 can receive this information and guide the boat to the destination waypoint as determined by the plotter. To use the NAV mode, complete the following steps.

Note: It takes 15 seconds to activate the NAV mode after the NAVpilot-511 receives the above information.

1. Set the destination waypoint (or route) on the plotter.
2. Manually steer the boat towards the waypoint.
3. Press the [NAV] key.

You are asked which port is used for the NAV mode PORT 1 or PORT 2 (depending on menu setting) . Press the course control knob to go to the NAV mode..

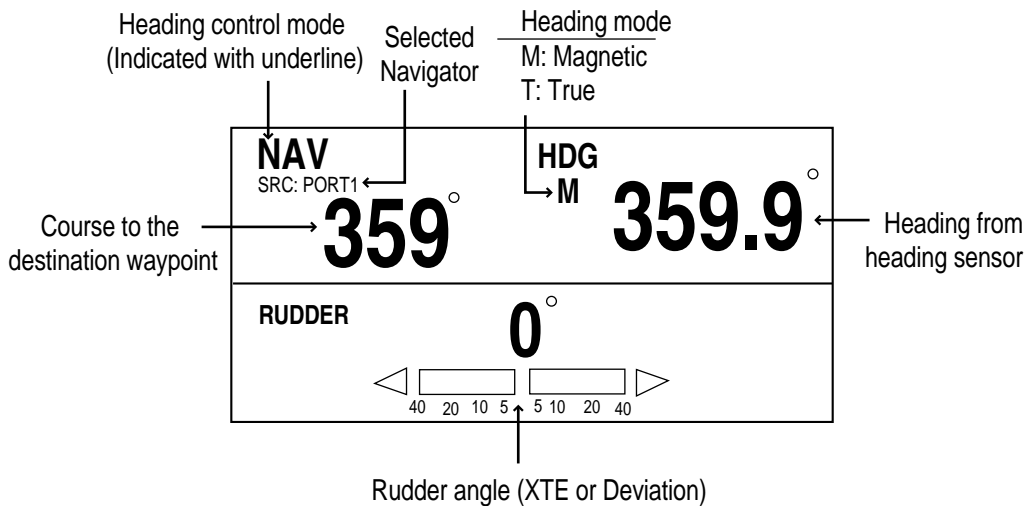

NAV mode display (Ex. Normal Display 2)

Note that while in the NAV mode, the course reading on the NAVpilot-511 will not always be the same as the waypoint direction shown on the plotter.

When you want to navigate a route, make sure that your plotter is navigating towards the nearest or desired waypoint before putting the NAVpilot-511 into the NAV mode.

4. Press the [STBY] key to terminate the NAV mode.

Note: You can switch the source port between PORT 1 and PORT 2 by pressing the [NAV] key more than three seconds.

3.3.2 Selecting sailing method of NAV mode

When your vessel goes off course while navigating between the origin (previous waypoint) and your current destination waypoint because of a remote control command, etc. the NAV mode uses one of two methods to get back on course: COURSE or XTE. (See figure in below.) If COURSE is selected, the NAVpilot-500 will calculate a new course based on your new position after dodging, etc. that will take you directly to your destination waypoint. If XTE is selected, the NAVpilot-511 will use XTE or cross track error to steer the boat towards your ORIGINAL course before dodging. You may select, either COURSE or XTE as shown below.

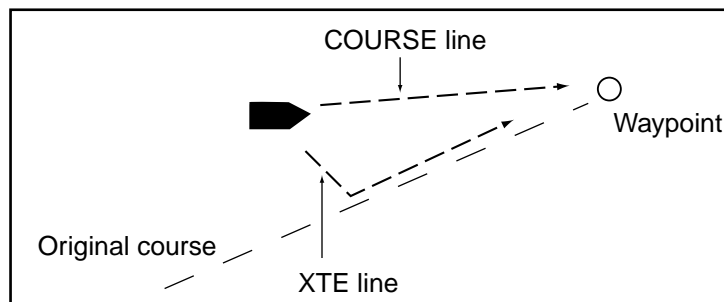

NAV mode, COURSE and XTE

The NAV mode steering method can be selected from the menu.

1. In the NAV mode, press the [TURN/MENU] key twice to show the NAV mode menu.
2. Rotate the course control knob to select "NAV MODE" on the second page, and then press it to show the nav mode options window.



Nav mode options window

3. Rotate the course control knob to select XTE or COURSE as appropriate.
5. Press the course control knob, and then press the [TURN/MENU] keys to close the menu.

3.3.3 Switching waypoint

When you arrive at a waypoint on a route while in the NAV mode, you can switch to the next waypoint automatically or manually. The AUTO setting will automatically switch to the next destination waypoint when your boat is within the arrival alarm area (set on the plotter). The MANUAL setting requires operator confirmation (pressing the course control knob) before switching to the next waypoint. When in MANUAL switching mode, the NAVpilot-511 will sound for five seconds an alarm when the vessel arrives at the destination waypoint.

AUTO: When your boat is within the arrival alarm area, the buzzer sounds for five seconds and the message “WPT WAS CHANGED” appears.

MANUAL: The message “WPT WAS CHANGED. PRESS ANY KEY.” appears when the vessel arrives at the destination waypoint.

1. In the NAV mode, press the [TURN/MENU] key twice to show the NAV mode menu.
2. Rotate the course control knob to select “WAYPOINT SWITCHING” on the second page.
3. Press the course control knob to show the waypoint switching window.



Waypoint switching options window

4. Rotate the course control knob to select AUTO or MANUAL as appropriate.
5. Press the course control knob and [TURN/MENU] key in order to close the menu.

3.3.4 Selecting the boat's steering behavior after arriving at your destination waypoint

The "Fishing mode" can be enabled and set up control your boat's steering behavior after it reaches the last waypoint in a route. For example, the ORBIT setting will steer the vessel in a circular pattern around the final waypoint (fishing spot). The FIGURE EIGHT setting will continually return to the final waypoint in a clover leaf pattern.

For details of each movement, see the next section "3.4 TURN Mode". To enable the fishing mode and set the steering behavior, complete the following steps:

1. Press the [STBY] key and then, [TURN/MENU] key twice to show the STBY menu.
2. Rotate the course control knob to select "PARAMETER SETUP", and then press it to show the parameter setup menu.
3. Rotate the course control knob to select "FISH MODE" on the second page, and then press it.
4. Rotate the course control knob to select ORBIT TO STBD (starboard), ORBIT TO PORT or FIGURE EIGHT.

To disable the fishing mode, select OFF. (The ship continues in the same direction that was active when the boat arrives at the last waypoint.)

5. Press the course control knob, and then press the [TURN/MENU] key twice to close the menu.

3.4 TURN Mode

The [TURN/MENU] key provides the various turning motions depending on the mode in use. There are five different turn type; 180° or 360° turns (for AUTO mode only), ORBIT, SPIRAL and FIGURE EIGHT. All turn type are available in clockwise and counterclockwise direction. To activate the TURN mode:

1. Press the [TURN/MENU] key once to show the TURN menu.

This menu will change based on the mode currently in use.

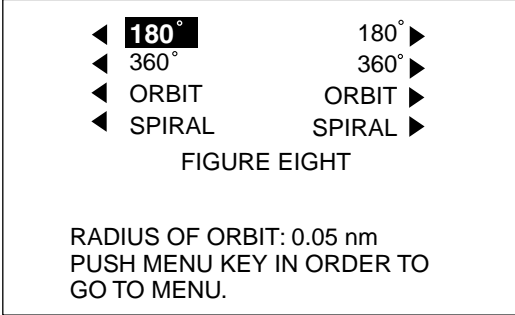
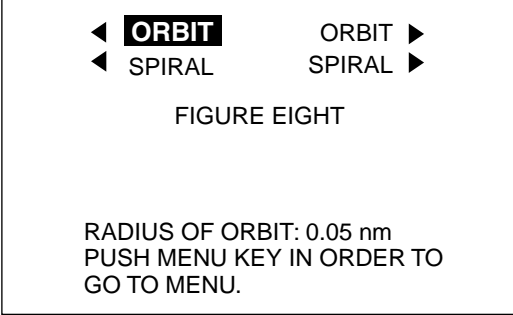
	
AUTO mode	STBY, NAV mode

Turn menu

2. Rotate the course control knob to select a mode.
The arrow next to the mode name shows the direction to turn.
3. Press the course control knob to execute.
Press the [TURN/MENU] key twice to close the TURN menu.

Note: When TLL data is input from a radar or echo sounder connected, the following TURN menu appears. For details, see page 3-15.

RECEIVED EXTERNAL TLL.
CANCEL
NAV

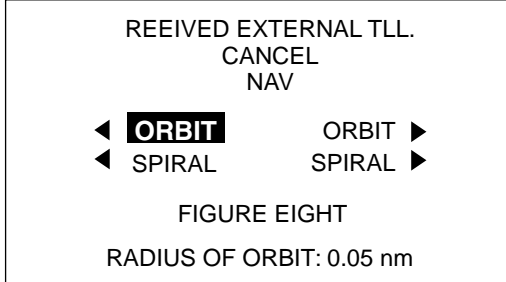

TURN menu (inputting TLL data)

180° TURN (for AUTO mode only)

This function changes the current set course by 180° in the opposite direction. After the 180° turn completely, the message “TURN COMPLETED” appears. Return to the AUTO mode by pressing the course control knob.

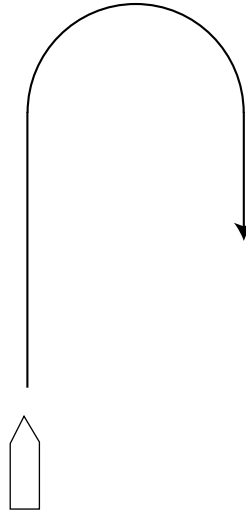

Example of 180° maneuver in turn mode

360° TURN (for AUTO mode only)

This function also provides a continuous turn feature with a constant rate of turn in a circle. This may be used for circling fish, purse seining, etc. After the 360° turn is complete, the message “TURN COMPLETED” appears. Return to the AUTO mode by pressing the course control knob.

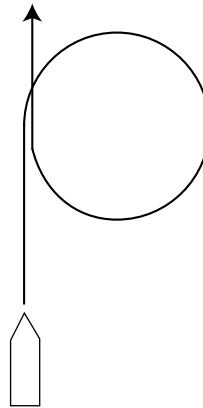

Example of 360° maneuver in turn mode

3. STEERING MODES

ORBIT

When ORBIT is enabled, your boat will orbit around the boat's current position. If ORBIT is enabled while in the NAV mode, the boat orbits around the (last) waypoint. This function requires a plotter or GPS be connected.

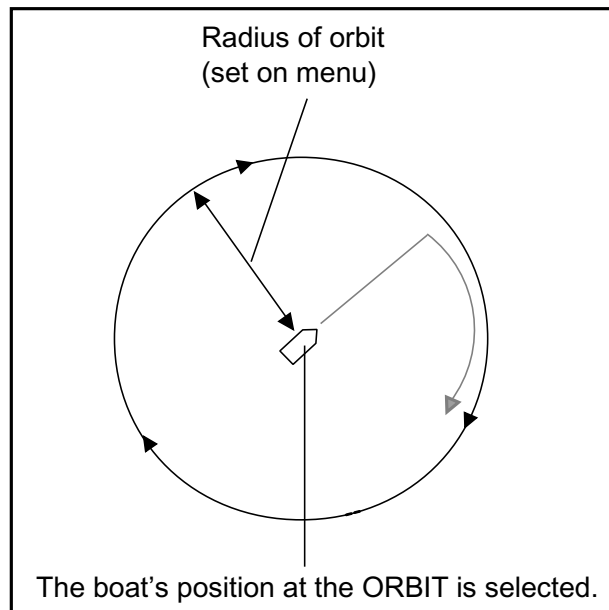

Example of orbit maneuver (ex. clockwise)

To set parameters for ORBIT, operate the autopilot as shown below.

 **WARNING**

Do not use the ORBIT mode in rough sea.

Because the boat turns a 360-degree circle around the waypoint a large wave or strong wind can cause the boat to capsize.

1. Press the [TURN/MENU] key once to show the TURN menu.
2. Rotate the course control knob to select "RADIUS OF ORBIT", and then press it to circumscribe the value with a double rectangle.
3. Rotate the course control knob to set the radius of orbit (Setting range: 0.05 to 9.99 nm), and then press it.

Note: The radius of orbit may be changed while the orbit mode activates.

4. Reduce boat's speed less than 10 kt.

5. Rotate the course control knob to select "◀ORBIT" or "ORBIT▶", and then press it.

The message "START TO TURN BY FISHING MODE" appears, and the boat runs for the distance set at step 3, and then starts making an orbit similar to the figure on the previous page.

If the boat's speed becomes more than 10 kt while orbiting, the message "TOO FAST TO FISHING MODE. PLEASE SLOW DOWN LESS THAN 10 kt. PUSH MENU KEY TO CANCEL AND GO TO AUTO MODE." appears. Reduce boat's speed less than 10 kt. In this case, the boat runs as shown below.

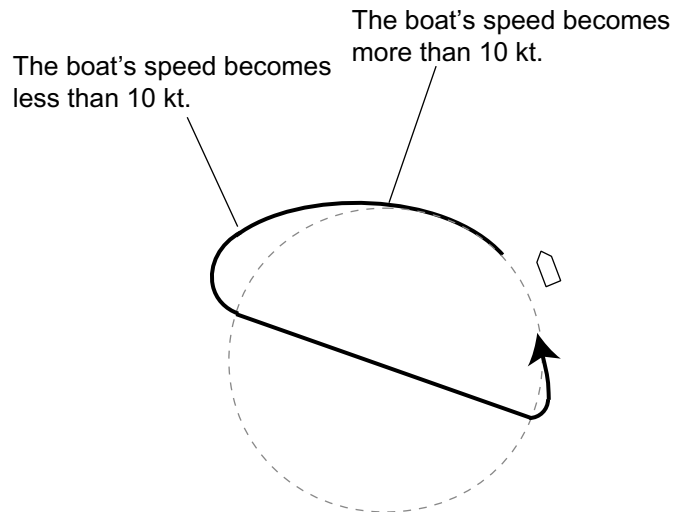

To escape from the ORBIT while it is in use, press [STBY] key.

Note: You can set the radius of orbit also at "PARAMETER SETUP" in the main menu.

3. STEERING MODES

SPIRAL

The boat will spiral in the direction of current heading (STBY), set course (AUTO) or the course to the next waypoint (NAV) that was active at the moment that the SPIRAL mode is selected. The spiral speed can be set in the menu.

In the NAV mode, the boat steers toward the waypoint (s) spirally. Note that the NMEA0183 sentence AAM is required from the plotter, and the arrival alarm range must also be set on the plotter.

Note 1: In the NAV mode, the SPIRAL deactivates the manual waypoint switching. (See paragraph 3.3.3.)

Note 2: If the boat does not enter the arrival alarm area, it may not be switched to the next waypoint. Set the arrival alarm range as large as possible and activate the perpendicular function on the plotter connected.

The boat will continue to orbit until the [AUTO] or [STBY] key is pressed.

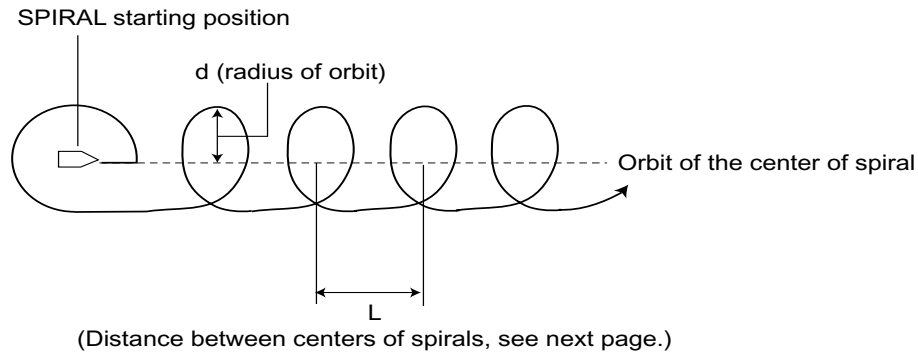

Example of spiral maneuver in turn mode

To execute the spiral, do the following.

1. Press the [TURN/MENU] key twice to show the main menu.
Rotate the course control knob to select "SPIRAL SPEED" on the second page.
For STBY mode;
 - a) Select "PARAMETER SETUP" in the main menu, and then press the course control knob to show the PARAMETER SETUP menu.
 - b) Select "SPIRAL SPEED" in there (on the second page).
2. Press the course control knob.
The current value is circumscribed with a double rectangle.
3. Rotate the course control knob to set the spiral speed. (Setting range: 0.1 to 8.0 kt)
Refer to the formula in below to set the radius of orbit and spiral speed.

$$L \text{ (distance between centers of spiral: nm)} = \frac{6.28 \text{ d (radius of orbit: nm)} \times V_c \text{ (spiral speed: kt)}}{V_s \text{ (ship's speed : kt)}}$$

4. Press the course control knob, and then press [TURN/MENU] key once (twice for STBY mode) to close the menu.
5. Press the [TURN/MENU] key once to show the TURN menu.
6. Rotate the course control knob to select "RADIUS OF ORBIT", and then press it to circumscribe the value with a double rectangle.
7. Rotate the course control knob to set the radius of orbit.
(Setting range: 0.05 to 9.99 nm)
8. Press the course control knob.
9. Reduce boat's speed less than 10 kt.
10. Rotate the [ENTER] knob to select "◀ SPIRAL" or "SPIRAL ▶".
11. Press the course control knob to start the spiral function.

The message "START TO TURN BY FISHING MODE" appears, and the boat runs for the distance set at step 7, and then starts making a spiral similar to the figure on the previous page.

If the boat's speed becomes more than 10 kt while orbiting, the message "TOO FAST TO FISHING MODE. PLEASE SLOW DOWN LESS THAN 10 kt. PUSH MENU KEY TO CANCEL AND GO TO AUTO MODE." appears. Reduce boat's speed less than 10 kt. In this case, the boat runs as shown on page 3-11.

12. To escape from the SPIRAL while it is in use, press [STBY] key.

FIGURE EIGHT

After the boat has traveled the distance "d" set on the TURN menu (or main menu), it starts turning in a figure eight pattern, automatically returning to the position where the figure eight mode was initiated. The "d" is set on menu as RADIUS OF ORBIT.

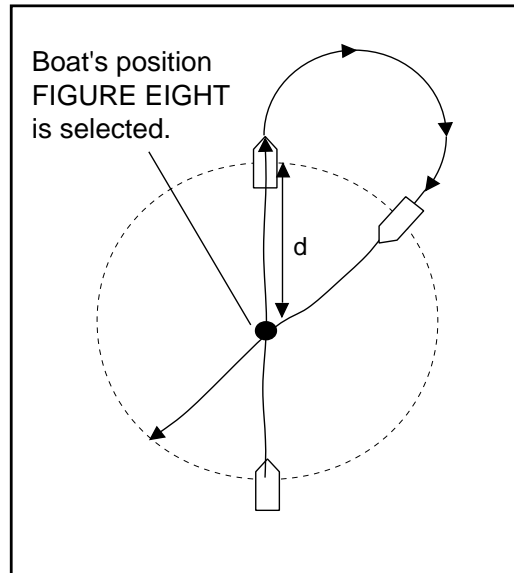

Example of FIGURE EIGHT (in NAV mode)

Note: Reduce boat's speed so that the boat can turn smoothly.

 WARNING
Confirm that no objection is in the general vicinity of the waypoint.
The distance from the waypoint to the turning point may be changed depending on boat's speed.

1. Press the [TURN/MENU] key once to show the TURN menu.
2. Rotate the course control knob to select "RADIUS OF ORBIT", and then press it.
The current value is highlighted.
3. Rotate the course control knob to set the radius for orbit. (Setting range: 0.05 to 9.99 nm.) The radius of orbit may be changed while the figure eight mode activates.
4. Press the course control knob.
5. Rotate the course control knob to select "FIGURE EIGHT".
9. Press the course control knob to start the figure eight motion.
To escape from the FIGURE EIGHT while it is in use, press [STBY] key.

Navigating to TLL point

When TLL (Target Latitude and Longitude) data is input from a radar or echo sounder connected in the STBY, AUTO or NAV mode, the TURN menu appears. Then, you may choose how to progress towards that position, from ORBIT (port direction, starboard direction) or FIGURE EIGHT. (You may also continue current steering mode, by choosing OFF.) Also, you can set the radius of orbit on this menu. For this mode, own ship's position L/L data and waypoint L/L data are required.

ORBIT

The boat makes circles around the TLL point.

SPIRAL

The boat goes to the TLL point spirally. After arriving to the TLL, the boat begins orbiting around there.

FIGURE EIGHT

The boat automatically returns to the TLL position when it goes more than a distance (set on menu) away from the TLL position.

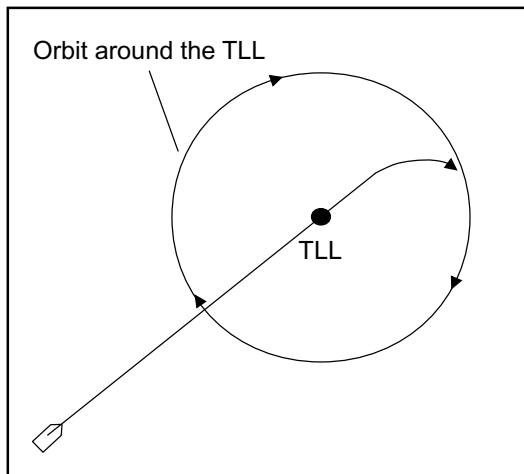

Orbit maneuver

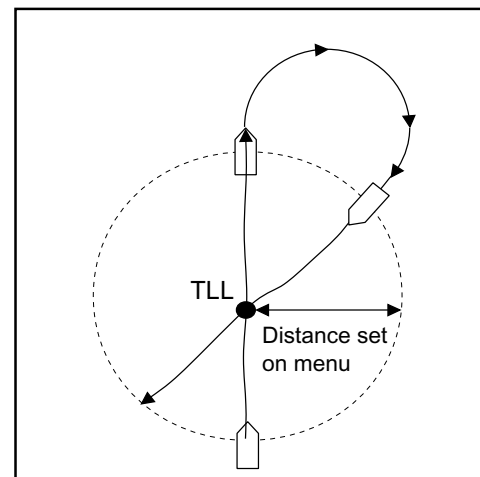
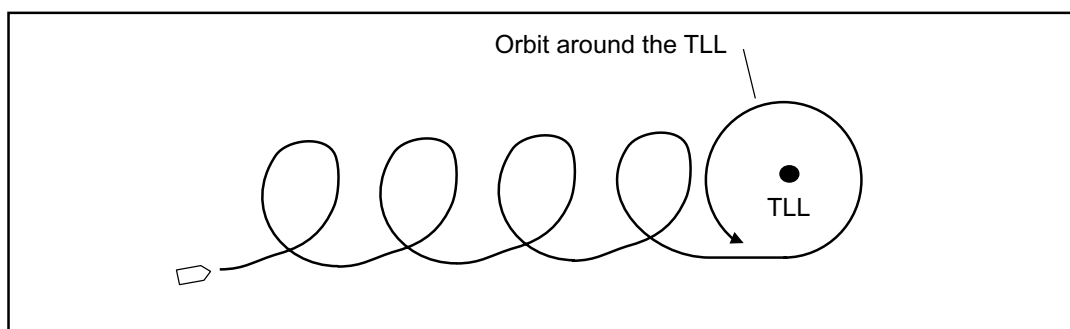

Figure eight maneuver



Spiral maneuver

TLL navigation

3.5 REMOTE Mode

Four types of optional remote controllers may be connected to the NAVpilot-511. These are used to operate the Navpilot-511 from a remote location.

Dial type remote controller (FAP-5551, 5552)

This remote controller can only be used when in the AUTO or NAV mode.

1. Turn on the remote controller switch to show “FU” (Follow-Up) on the control unit. If the remote controller switch is turned on when in the STBY mode, a beep sounds to alert you that remote mode is not available.

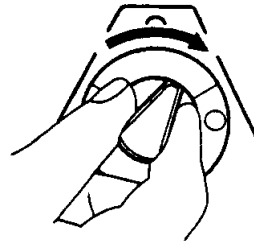

Turning power on (dial type)

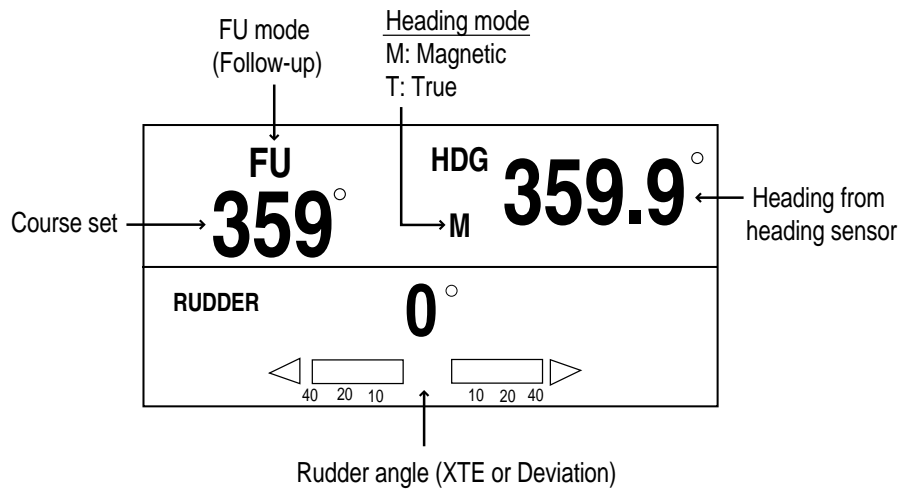

FU (Follow-Up) mode display (dial remote controller)

FU is one of auto steering modes, which outputs an absolute value determined with the course control knob to drive the rudder, thus changing the ship's course at a given rate of change towards a set point..

2. Rotate the dial on the remote controller to set the rudder angle. The angle must be more than 10°, otherwise no steering will occur.

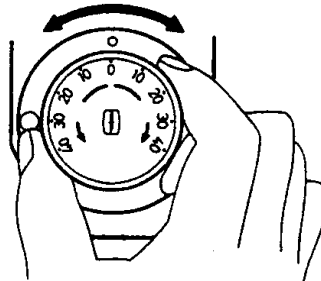

Rotating dial

3. When you terminate the REMOTE mode, turn off the remote controller.

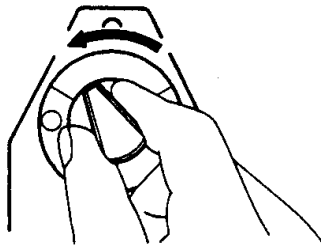

Turning power off (dial type)

Control is returned to the main control unit and the mode that was originally active (AUTO or NAV) is restored. For the NAV mode, the boat will go to the destination waypoint based on the (COURSE or XTE) Nav steering method menu setting See paragraph 3.3.2. for an explanation of this setting.

3. STEERING MODES

Button (FAP-6211, 6212), Lever (FAP-6221, FAP-6222),

Dodge (FAP-6231, 6232) type remote controller

These controllers may be used in the STBY, AUTO and NAV modes.

1. For button and lever type remote controllers, turn on the remote controller power.

The dodge type remote controller doesn't have the power switch, it can be operated by simply pressing the direction buttons.

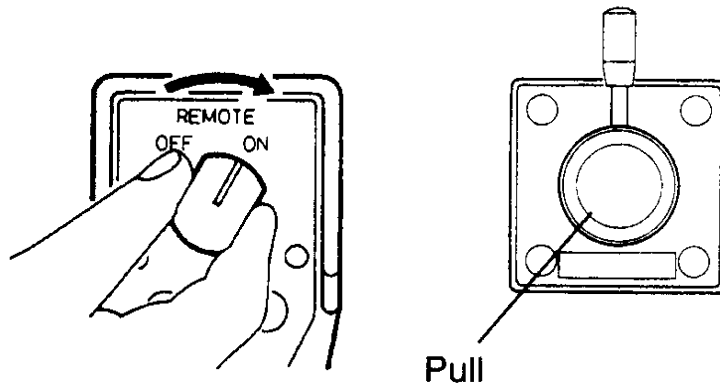

Turning power on, button and lever type remote controllers

The indication "NFU" (No Follow-Up) appears on the control unit. (For dodge type, NFU appears while a direction key on it is pressed.)

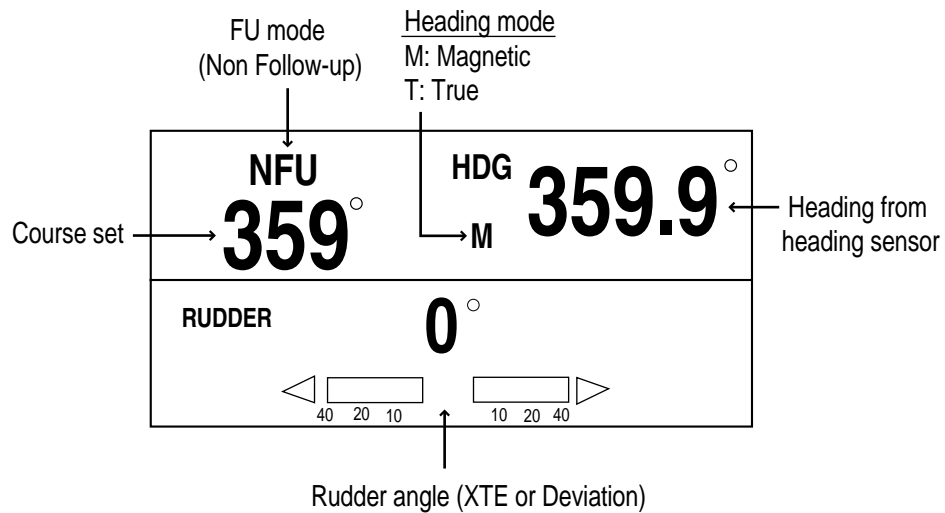

NFU (No Follow-Up) mode display

Non-Follow up (NFU) is a manual steering mode that moves the rudder as long as the button or lever is pressed.

- For button and dodge remote controllers, press the [PORT] or [STBD] key on the remote controller. For the lever type, position the lever for the direction.

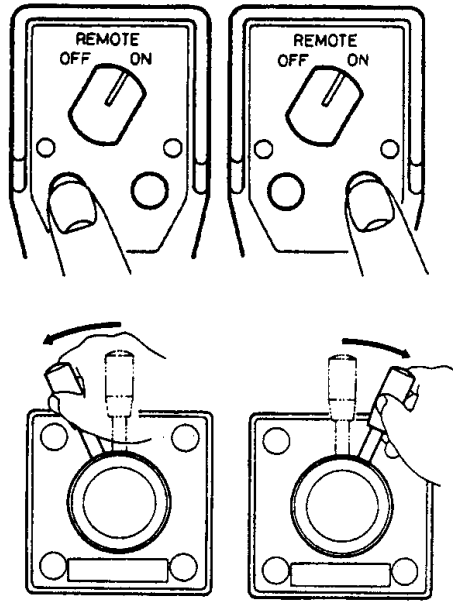

Operating remote controller (ex. button and lever types)

- For the button and lever type remote controllers, turn off the remote controller to terminate the REMOTE mode. (For dodge type remote controller, simply release a key.) Control is returned to the control unit and the previously used mode (STBY, AUTO or NAV) is restored.

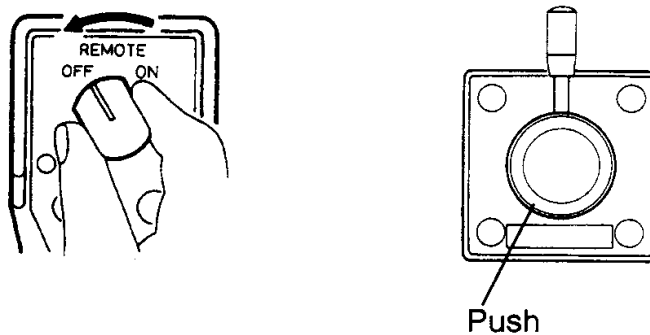

Turning power off, button and lever type remote controllers

3.6 DODGE Mode

The DODGE mode is useful in situations where you need to quickly take control of the helm to avoid an obstruction.

3.6.1 Dodging in STBY mode

1. Press the [PORT] or [STBD] key down to steer appropriately until the boat finishes the turning.

The equipment goes into the DODGE mode while pressing the [PORT] or [STBD] key. In this mode, steering can not be done from other control units or remote controllers. Further the audible alarm sounds when one of the above keys is operated, to alert you to dodge operation. Note also that “DODG” appears on the display.

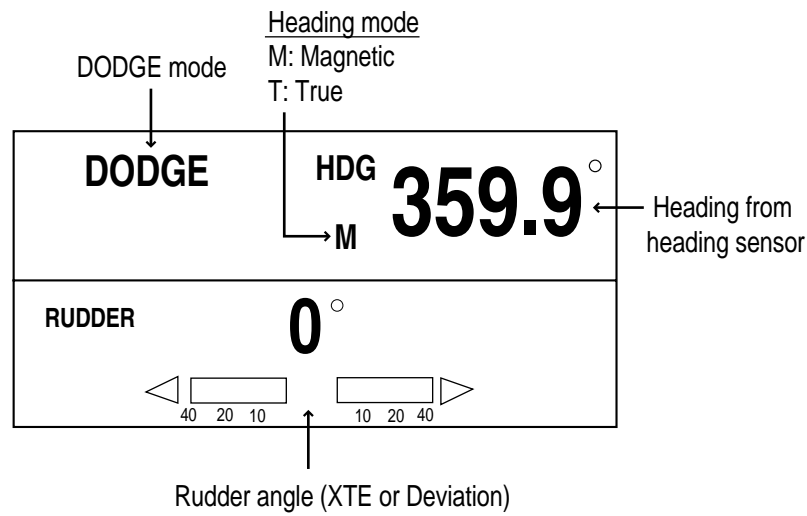

Dodge mode display 1

Note: To move the rudder to 0° point, press the [PORT] and [STBD] keys at the same time.

2. Release the [PORT] or [STBD] key to leave from the DODGE mode.

3.6.2 Dodging in AUTO or NAV mode

1. Press the [PORT] or [STBD] key down to change the course until the boat finishes to avoid the obstruction.

The equipment goes into the DODGE mode and the audible alarm sounds when one of the above keys is operated, to alert you to dodge operation. Note also that "DODG" appears on the display.

Note: Press the [PORT] and [STBD] keys together to fix the course setting value.

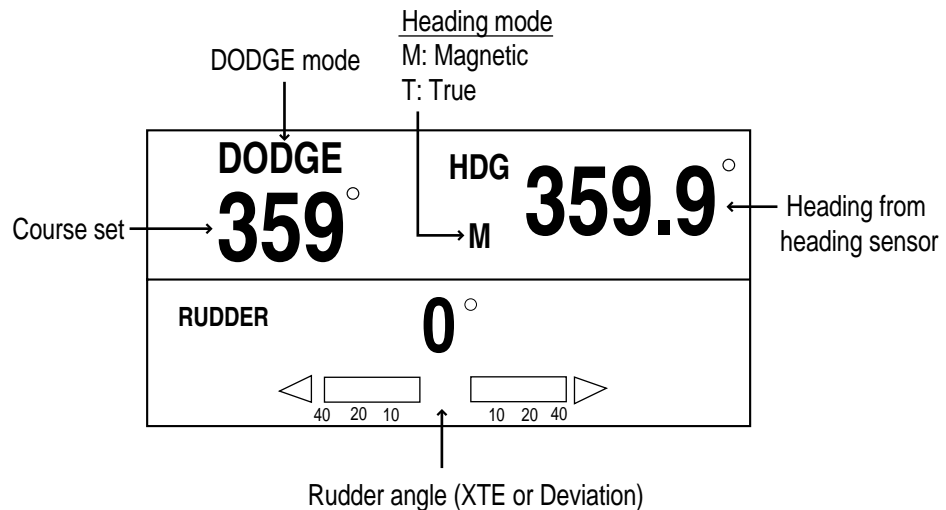

Dodge mode display 2

2. Release the key pressed to return to the previous mode (AUTO or NAV). You can operate the autopilot with the status before the DODGE mode.

3. STEERING MODES

This page is intentionally left blank.

4. MENU OPERATION

Most settings are carried out in the menus. The items shown in each menu depend on the mode in use. For the STBY mode the complete menu is shown. When the menu is accessed while in either the AUTO or NAV modes, only the menu items that are most frequently used in those modes are shown.

The ALARM SETUP menu description is shown on Chapter 5.

4.1 STBY Mode Menu

While in the STBY mode, press the [TURN/MENU] key twice to show the STBY mode menu. This menu shows all of the Navpilot-511's menu items.

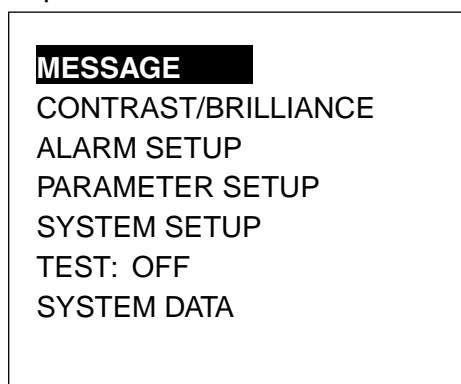

STBY mode menu

4. MENU OPERATION

4.1.1 Setting parameters

The PARAMETER SETUP menu sets various parameters for the control of the NAVpilot-511.

1. In the STBY mode, press the [TURN/MENU] key twice to open the STBY mode menu.
2. Rotate the course control knob to select "PARAMETER SETUP".
3. Press the course control knob to show the PARAMETER SETUP menu.

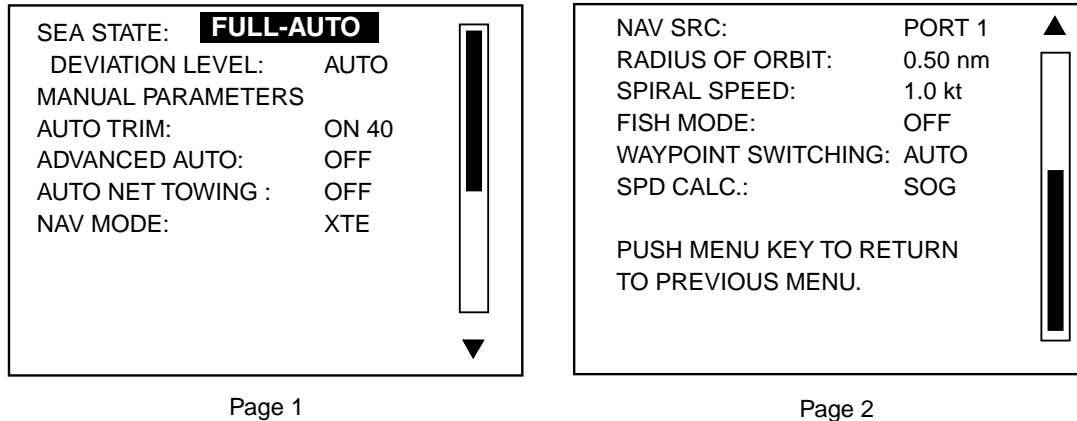

Page 1

Page 2

Parameter setup menu

4. To close the PARAMETER SETUP menu, press the [TURN/MENU] key twice.

Selecting the method of entering the parameter

The NAVpilot-511 has an automatic adjustment feature which sets up the equipment according to ship's characteristics and sea state for optimum performance in the AUTO and NAV modes. In addition, a self-learning algorithm is incorporated: Parameters for rudder ratio, counter rudder and auto trim gains are constantly optimized based on the steering history of your boat, and are stored in memory for future navigation.

You choose how the NAVpilot-511 will steer the vessel, (manual or automatic sea state parameter adjustment) as follows:

1. Rotate the course control knob to select "SEA STATE" from the PARAMETER SETUP menu.
2. Press the course control knob to show the sea state options window.

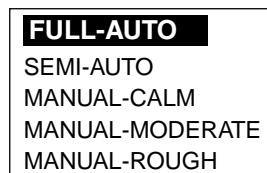

Sea state options window

3. Rotate the course control knob to select FULL-AUTO, SEMI-AUTO, MANUAL-CALM, MANUAL-MODERATE or MANUAL-ROUGH as appropriate, and then press the course control knob.

FULL-AUTO: Auto adjustment and self-learning are on.

SEMI-AUTO: Auto adjustment is on, self-learning is off.

MANUAL-CALM: Self-learning is off, using the parameter selected for calm sea.

MANUAL-MODERATE: Self-learning is off, using the parameters for a typical normal sea state.

MANUAL-ROUGH: Self-learning is off, using preset parameters for a typical rough sea state.

For normal, everyday operation, the FULL-AUTO mode is recommended. However, if you want the NAVpilot-511 to steer the boat based on experience-related parameters, but you don't want the pilot to be in "self-learning" mode, choose the SEMI-AUTO option.

Note that the course keeping quality may be decreased if the sea state is different from the experience-related parameters. This option is provided if you happen to be using the pilot in a situation that you do not anticipate encountering again.

4. When selecting "FULL-AUTO" at step 3, set DEVIATION LEVEL as follows:
 - a) Rotate the course control knob to select "DEVIATION LEVEL".
 - b) Press the course control knob to show the deviation level options window.



Deviation level options window

- c) Rotate the course control knob to select "AUTO" or "LEVEL" as appropriate. For LEVEL, you may set a value between 1 and 9. A lower number keeps the course more exactly, but the rudder may be turned more often. With a higher number, the rudder is fixed, but the course may not be kept as accurately.
 - d) Press the course control knob twice to close the window.

4. MENU OPERATION

Setting parameters manually

When MANUAL-CALM, MODERATE or ROUGH is selected at the previous paragraph, set MANUAL PARAMETERS as below.

You can set three parameters for MANUAL function: Weather, Rudder gain and Counter rudder.

The default manual parameters provide for comfortable steering of a boat 35 feet in length at the speed of 10 kt. When speed is increased to 20 kt, the manual parameters are automatically reduced 66%.

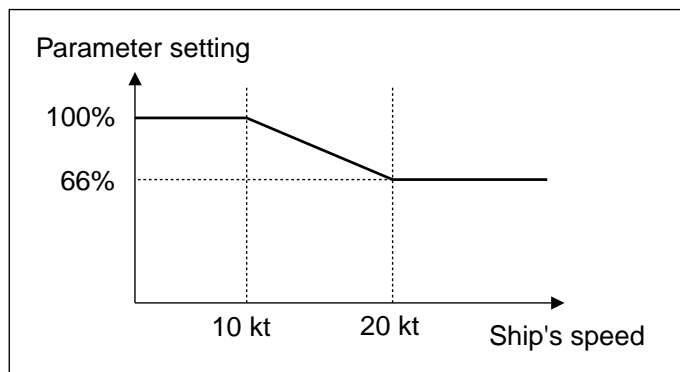

1. Rotate the course control knob to select MANUAL PARAMATERS from the PARAMETER SETUP menu.
2. Press the course control knob to show the following table.

Example of Manual parameter

	SEA STATE		
	CALM	MODERATE	ROUGH
WEATHER	1°	2°	3°
RUDDER GAIN	0.4	0.5	0.6
COUNT RUDDER	0.2	0.3	0.4

Refer to the followings to set parameters:

Boat longer than 35 feet: Set parameters smaller than default parameters.

Boat shorter than 35 feet: Set parameters larger than default parameters.

3. Rotate the course control knob to choose WEATHER-CALM setting, and then press the course control knob.
4. Rotate the course control knob to set value (Setting range: 1° to 10° for weather).
5. Press the course control knob.
6. Set WEATHER-MODERATE, WEATHER-ROUGH and RUDDER GAIN and COUNT RUDDER similarly (Setting range: 0.1 to 2.0 for rudder gain, 0.1 to 4.0 for counter rudder).
7. Press the [MENU] key to close the table.

WEATHER

When the sea is rough, the boat's heading fluctuates to port and starboard. If the rudder is driven very often to maintain the set course, the helm mechanism may wear out. To prevent this, the weather adjustment makes the NAVpilot-511 insensitive to minute course deviations. You may choose a degree between 1° to 10°. Until the course deviation exceeds the selected setting, steering to correct the heading will not be initiated.

The illustration below shows boat's track lines with weather setting 3° and 7°. When 7° is set, for example, the rudder is not driven until the course deviation exceeds 7°. Increasing the setting reduces activation of the steering gear, however the boat tends to zigzag. When the sea is calm, set a smaller value.

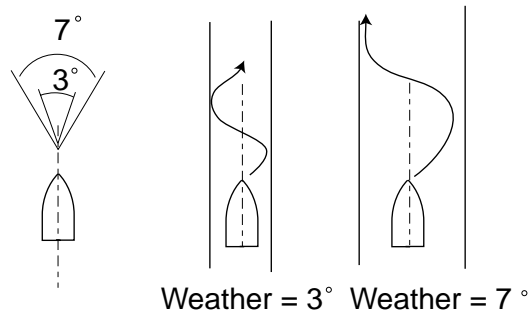

Track line and weather setting value

RUDDER GAIN

When the boat's heading deviates from the set course, the NAVpilot-511 adjusts the rudder to correct it. The rudder angle (number of degrees) which is steered against every degree of course deviation is known as the rudder gain.

The following illustrations show how many degrees the NAVpilot-511 steers the rudder in order to nullify 10 degrees of course deviation with various settings of the rudder gain.

Rudder gain = 0.1

Rudder gain = 0.3

Rudder gain = 0.8

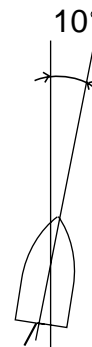
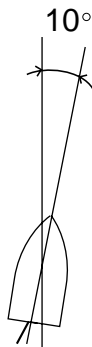

Rudder angle = $10^\circ \times 0.1 = 1^\circ$ Rudder angle = $10^\circ \times 0.3 = 3^\circ$ Rudder angle = $10^\circ \times 0.8 = 8^\circ$

Rudder angle and rudder gain setting

4. MENU OPERATION

Set rudder gain so that the boat does not make frequent yaw. The figure shown below provides general guidelines for setting rudder gain.

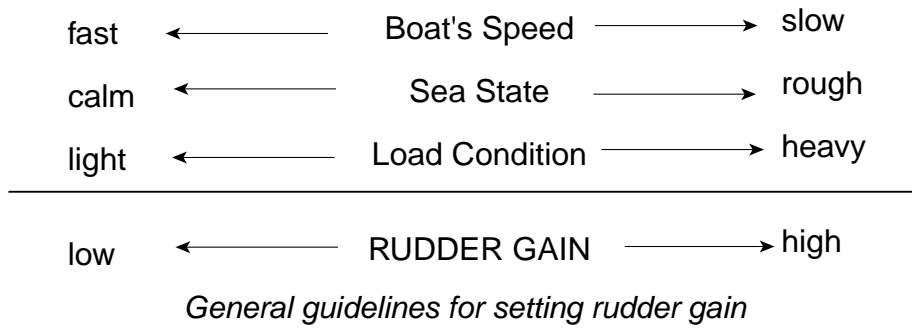

COUNTER RUDDER

If the boat is heavily loaded, the heading could change excessively because of inertia. This phenomenon causes the vessel to “overshoot” the intended course. If this happens, the NAVpilot-511 will steer the rudder to the opposite side and the heading will turn in opposite direction excessively again. In an extreme case the heading oscillates several times until it finally settles in the new course. An adjustment known as “counter rudder” prevents this kind of oscillation.

Counter rudder is usually not required for small boats. When your boat zigzags a lot before settling in the new course, increase the counter rudder setting.

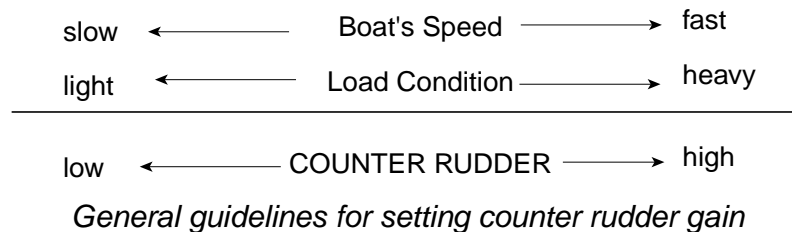
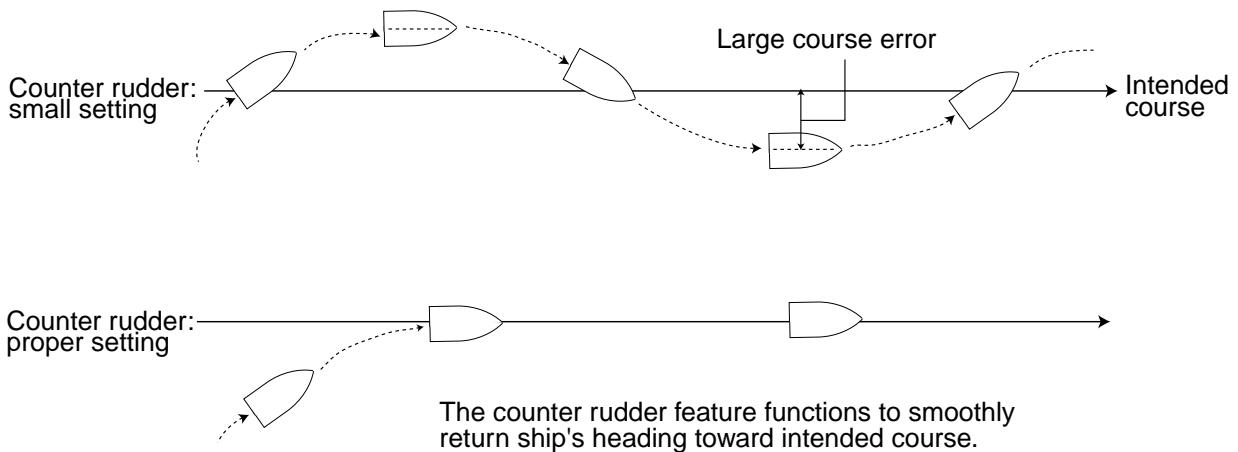

Adjusting the sensitivity in monitoring the boat's trim

The NAVpilot-511 continually monitors the boat's trim in order to keep the trim sensitivity optimum. A lower setting is common because boat's trim usually does not change quickly. A large number changes the trim compensation value more frequently. Too high of a setting may result in the following problems.

- Trim sensitivity is over-affected, resulting that a trim appears in both port and starboard directions alternately.
- Trim compensation mechanism responds to the yawing, resulting in more serious oscillation of ship's heading.

To set the auto trim sensitivity:

1. Rotate the course control knob to select AUTO TRIM from the PARAMETER SETUP menu.
2. Press the course control knob to show the auto trim options window.



Auto trim options window

3. Rotate the course control knob to select "ON".
4. Press the course control knob.
5. Rotate the course control knob to select current value.
6. Press the course control knob and the current value is circumscribed with a double rectangle.
7. Rotate the course control knob to set value (Setting range: 1 to 100, the default setting is calculated automatically depending on the ship's length entered on the DOCK SIDE SETUP menu.)
8. Press the course control knob to finish.

4. MENU OPERATION

When towing the net

When a boat is in tow of the fishing gear, its stern is “dragged” by the net. This causes the boat to stray from its intended course. To keep the boat on course, you need to adjust the trim manually, which can be bothersome. If you do not want to be bothered with trim adjustments, you can enable the automatic towing function to have the trim automatically adjusted. This feature is very valuable for trawlers and purse seiners.

1. Rotate the course control knob to select “AUTO NET TOWING” from the PARAMETER SETUP menu.
2. Press the course control knob to show the net towing options window.



Auto net towing options window

3. Rotate the course control knob to select ON or OFF as appropriate.
4. Press the course control knob to finish.

If the AUTO NET TOWING setting is done on the AUTO mode menu, press the [STBY] key to go into STBY mode and then press the [STBY] key to return to the AUTO mode to activate this function.

Note that you must keep the boat on a straight course before the AUTO mode is selected.

NAV MODE

See the paragraph 3. 3. 2. "Selecting sailing method of NAV mode".

Selecting the navigator connected

When two navigators are connected, you can select one appropriately.

1. Rotate the course control knob to select "NAV SRC" from the PARAMETER SETUP menu.
2. Press the course control knob to show the nav mode data source window.

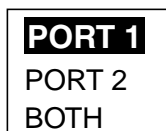

Nav mode data source window (ex. default setting)

3. Rotate the course control knob to select PORT 1*, PORT 2* or BOTH as appropriate. For “BOTH”, Navpilot-511 uses the port input the higher priority data (See the installation manual). If same priority data are input to the port 1 and port 2, the port 1 is used.
4. Press the course control knob to finish.

*: Default set name. These can be changed on the installation menu.

RADIUS OF ORBIT

See the section 3.4 "TURN Mode".

SPIRAL SPEED

See the section 3.4 "TURN Mode".

FISH MODE

See the section 3.4 "TURN Mode".

WAYPOINT SWITCHING

See the section 3.3.3 "Switching waypoint".

Selecting speed format

You can choose speed format among from SOG, STW and MANUAL.

1. Rotate the course control knob to select "SPD CALC."
2. Press the course control key to show the speed calculation window.

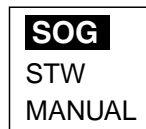

Speed calculation window

3. Rotate the course control knob to select SOG, STW or MANUAL as appropriate.
When selecting MANUAL, enter the speed manually.
4. Press the course control knob to finish.

The NAVpilot-511 controls the boat (for ORBIT, SPIRAL function, etc.) by using the speed selected here. When MANUAL is selected and there is a large difference between actual and entered speeds, the boat may not be controlled correctly. We recommend using of GPS speed.

4. MENU OPERATION

4.1.2 Setting other menu items

The SYSTEM SETUP menu allows you to set various item according to your operating needs.

1. Open the STBY mode menu.
2. Rotate the course control knob to select "SYSTEM SETUP".
3. Press the course control knob to show the SYSTEM SETUP menu.

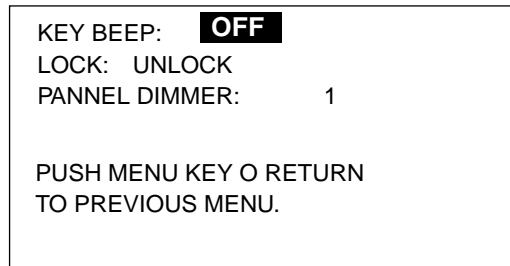

System setup menu

Activating key beep

Turn the key beep on or off.

1. Rotate the course control knob to select "KEY BEEP" on the SYSTEM SETUP menu.
2. Press the course control knob to show the key beep options window.



Key beep options window

3. Rotate the course control knob to select ON or OFF as appropriate.
4. Press the course control knob.

Locking the control unit

The LOCK feature renders the following commands inoperative from the control unit at which the LOCK feature has been actuated.

- Menu operation
- Changing the steering mode
- Course setting
- Waypoint switching

1. Rotate the course control knob to select “LOCK” from the SYSTEM SETUP menu.
2. Press the course control knob to show the lock options window.



Lock options window

3. Rotate the course control knob to select “LOCK” or “UNLOCK” as appropriate.
4. Press the course control knob.

To unlock, press the [STBD] (▶) key while holding the [TURN/MENU] key down.

4. MENU OPERATION

Setting the panel dimmer

You can adjust the control panel dimmer as follows.

1. Rotate the course control knob to select "PANEL DIMMER" from the SYSTEM SETUP menu.
2. Press the course control knob and the current value is circumscribed with a double rectangle.
3. Rotate the course control knob to set value (Setting range: 1 to 8). The higher the number the greater the illumination.
4. Press the course control knob.



5. ALARMS

5.1 ALARM SETUP Menu



The NAVpilot-511 has seven conditions which generate both audio and visual alarms: watch alarm, deviation alarm, XTE (cross-track error) alarm, speed alarm, depth alarm, temp alarm and log trip alarm. You may set up the alarms on the ALARM SETUP menu.

1. Press the [TURN/MENU] key twice to show the mode menu.
2. Rotate the course control knob to select "ALARM SETUP".
3. Press the course control knob to show the ALARM SETUP menu.

Page 1

AUDIO:	INTERNAL BUZZER	
ALARM INTERVAL:	SHORT	
WATCH ALARM:	OFF	
DEVIATION ALARM:	90°	
XTE:	OFF	
SPD:	OFF	
DPT:	OFF	
		

Page 2

TMP:	OFF	
TRIP LOG ALARM:	OFF	
CLEAR TRIP LOG:	NO	
PUSH MENU KEY TO RETURN TO PREVIOUS MENU.		

Alarm setup menu

4. Press the [TURN/MENU] key to close the ALARM SETUP menu.

5.1.1 Selecting the alarm buzzer

You may choose the buzzer from which to output the audio alarm as follows. Use the external buzzer connected to the processor unit if the internal buzzer volume is small.

Note: If “INTERNAL + EXTERNAL” is selected, the external buzzer sounds when turning the NAVpilot-511 off.

1. Rotate the course control knob to select “AUDIO” from the ALARM SETUP menu.
2. Press the course control knob to show the audio alarm options window.

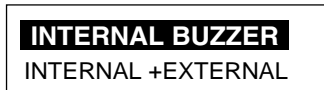

Audio alarm options window

3. Rotate the course control knob to select INTERNAL BUZZER or INTERNAL+EXTERNAL as appropriate.
 INTERNAL BUZZER: Sounds the buzzer in the control unit.
 INTERNAL+EXTERNAL BUZZER: Sounds the control unit buzzer and external buzzer if connected.
4. Press the course control knob.

5.1.2 Selecting the beep pattern

The sound pattern of the audio alarm (WATCH ALARM, DEVIATION ALARM, XTE ALARM, SPEED ALARM, DEPTH ALARM and TEMP ALARM) can be selected as follows.

1. Rotate the course control knob to select “ALARM INTERVAL” from the ALARM SETUP menu.
2. Press the course control knob to show the alarm interval options window.



Alarm interval options window

3. Rotate the course control knob to select SHORT, LONG or CONTINUE as appropriate.

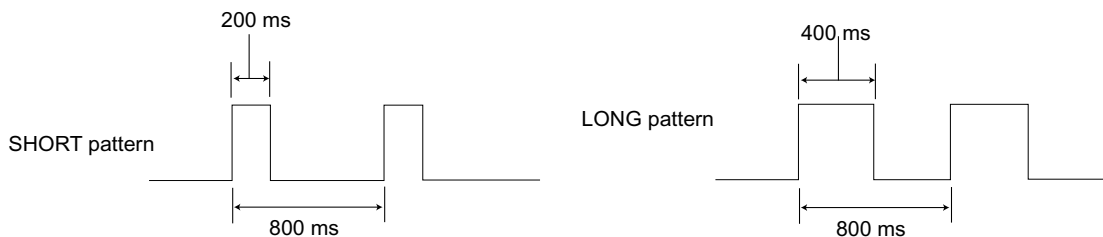

CONTINUE: Beep sounds continuously.

4. Press the course control knob.

5.1.3 Setting the watch alarm

The watch alarm periodically warns the helmsman to check the autopilot when in the AUTO or NAV mode.

1. Rotate the course control knob to select “WATCH ALARM” from the ALARM SETUP menu.
2. Press the course control key to show the watch alarm options window.



Watch alarm options window

3. Rotate the course control knob to select “ON” or “OFF” as appropriate. When selecting “ON”, you can set the time interval (1 to 10 min) at which to be alerted. If the set time passes without operation, the alarm sounds. Further, if three minutes elapse after the watch alarm has sounded, the message “TOUCH ME” appears. Press any key to clear the alarm.
4. Press the course control knob.

5.1.4 Setting the heading deviation alarm

The deviation alarm sounds when the heading deviates more than a limit set than the current heading in the AUTO or NAV mode.

1. Rotate the course control knob to select “DEVIATION ALARM” from the ALARM SETUP menu.
2. Press the course control knob and the current value is circumscribed with a double rectangle.
3. Rotate the course control knob to set the degree of deviation (Setting range: 1 to 90°).
4. Press the course control knob.

5.1.5 Setting the cross-track error limit

When in the NAV mode, the XTE alarm will sound when the course error has exceeded or falls within the range set in the following steps:

1. Rotate the course control knob to select “XTE” from the ALARM SETUP menu.
2. Press the course control knob to show the XTE alarm options window.



XTE alarm options window

3. Rotate the course control knob to select “OFF” or “ON” as appropriate.
OFF: Turn the XTE alarm off.
ON: The alarm is released when exceeding the XTE range is exceeded.
For ON, set the range (0.001 to 9.999 nm/km/sm) using the course control knob.
4. Press the course control knob.

5.1.6 Setting the speed alarm

The speed alarm warns you when your boat's speed is within, outside, over or under the speed range setting.

1. Rotate the course control knob to select "SPD" from the ALARM SETUP menu.
2. Press the course control knob to show the speed alarm options window.

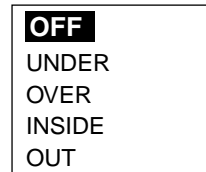

Speed alarm options window

3. Rotate the course control knob to select speed alarm condition.

OFF: Turn the speed alarm off.

UNDER: The alarm is sounded when ship's speed is under the set value.

OVER: The alarm is sounded when the ship's speed is over the set value.

INSIDE: The alarm released when ship's speed is within the range set.

OUT: The alarm is released when ship's speed is outside the range set.

When selecting INSIDE or OUT OF RANGE, set the upper and lower limits, using three digits. For OVER and UNDER, set value (Setting range: 0.0 to 999.9 kt, km/h or mph). This alarm uses the speed set at SPEED CALCULATION on the SYSTEM SETUP menu.

4. Press the course control knob.

5.1.7 Setting the depth alarm

The depth alarm sounds when the bottom is shallower, deeper within or outside the range setting.

Note: To use the depth alarm, depth data from an external sounder is required.

1. Rotate the course control knob to select “DPT” from the ALARM SETUP menu.
2. Press the course control knob to show the depth alarm options window.

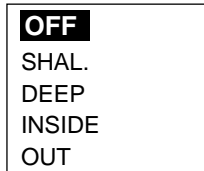

Depth alarm options window

3. Rotate the course control knob to select the condition.
OFF: Turn the depth alarm off.
SHAL. (shallow): The alarm is released when the bottom is shallower than the value set.
DEEP: The alarm is sounded when the bottom is deeper than the value set.
INSIDE: The alarm is sounded when the bottom is within the range set.
OUT: The alarm released when the bottom is outside the range set.
When selecting INSIDE or OUT OF RANGE, set upper and lower limits, using three digits. For SHALLOW or DEEP, set a value (Setting range: 0 to 9999.9 ft/m/FA/PB).
4. Press the course control knob.

5.1.8 Setting the temperature alarm

There are five types of water temperature alarms: UNDER, OVER, INSIDE, OUT and CURRENT RIP. The UNDER and OVER alarms sound when the water temperature is lower or higher than the value set, the INSIDE and OUTSIDE alarms sound when the water temperature is within or outside the range set. For CURRENT RIP, the alarm sounds when the temperature changes over the value set within a minute.

1. Rotate the course control knob to select “TMP” from the ALARM SETUP menu.
2. Press the course control knob to show the temp alarm options window.

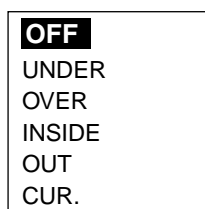

Temp alarm options window

3. Rotate the course control knob to select the water temperature condition.
When selecting the INSIDE, OUT or CUR. (current lip), set the number for upper and lower limits. For UNDER or OVER, set a value (Setting range: 0 to 120°F or -20 to 50°C).
4. Press the course control knob.

5.1.9 Setting the trip distance alarm

The log trip alarm alerts you a defined distance has been reached.

1. Rotate the course control knob to select “TRIP LOG ALARM” from the ALARM SETUP menu.
2. Press the course control knob to show the log trip options window.



Log trip options window

3. Rotate the course control knob to select “ON” or “OFF” as appropriate.
When selecting ON, set appropriate value (Setting range: 0 to 9999 nm/km/sm).
4. Press the course control knob.

5.1.10 Clearing the trip distance

You can reset the trip distance to zero as follows.

1. Rotate the course control knob to select “CLEAR TRIP LOG” from the ALARM SETUP menu.
2. Press the course control knob to show the log trip clear options window.



Log trip clear options window

3. Rotate the course control knob to select “YES” to reset the trip distance.
4. Press the course control knob.

5.2 Alarm Information

When an alarm condition occurs, the buzzer sounds and the “!” icon and alarm type window appears on the screen. Press any key to silence alarm and hide the window. You can see which alarm has been violated on the MESSAGE window. In the example below the deviation alarm has been violated.

1. Press the [TURN/MENU] key twice to show the menu.
2. Rotate the course control knob to select “MESSAGE”, and then press the course control knob to show the message window.

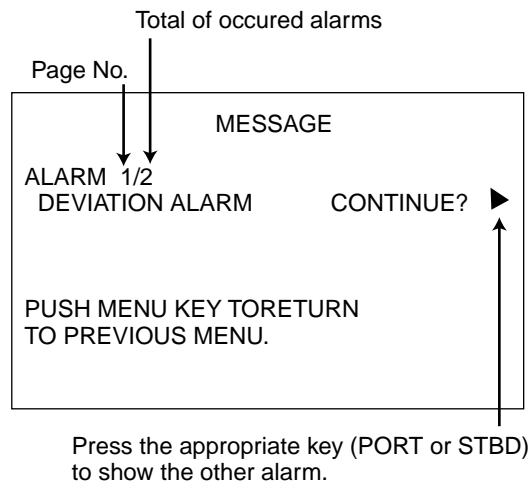

Alarm menu

3. Confirm the alarm message.
4. Press the [TURN/MENU] key twice to finish.

5. ALARMS

Alarm messages

The table below shows the alarm messages, their meanings and priorities.

Alarm messages, their meanings and priorities

Message	Meaning	Priority
DEVIATION ALARM	Deviation alarm has occurred.	1
CROSS TRACK ERROR	XTE alarm has occurred.	2
SPEED ALARM	Speed alarm has occurred.	3
DEPTH ALARM	Depth alarm has occurred.	4
WATER TEMP. ALARM	Temperature alarm has occurred.	5
TRIP ALARM	Log alarm has occurred.	6

6. MAINTENANCE & TROUBLESHOOTING

This chapter provides information necessary for keeping your unit in good working order and remedying simple problems.

WARNING

Do not open the equipment.

Hazardous voltage which can cause electrical shock exists inside the equipment. Only qualified personnel should work inside the equipment.

6.1 Preventive Maintenance

Regular maintenance is important for optimum performance. A maintenance schedule should be established and should at least include the items below.

Maintenance program

Item	Check point	Remedy
Control unit connector	Check for tight connection.	Tighten loosened connectors.
LCD	The LCD will, in time, accumulate a coating of dust which tends to dim the picture.	Wipe the LCD carefully to prevent scratching, using tissue paper and an LCD cleaner. To remove dirt or salt deposits, use an LCD cleaner, wiping slowly with lens paper so as to dissolve the dirt or salt. Change paper frequently so the salt or dirt will not scratch the LCD. Do not use solvents such as thinner, acetone or benzene for cleaning.
Ground terminal	Check for tight connection and corrosion.	Clean or replace ground wire as necessary.

6.2 Replacement of Fuse

The fuse in the processor unit protects the equipment from reverse polarity of the ship's mains and equipment fault. If the fuse blows, the power cannot be turned on.

Contact your dealer about replacement of the fuse.

 CAUTION
<p>Use the proper fuse.</p> <p>Use of a wrong fuse can cause fire or damage the equipment.</p>

Parts Name	Type	Code No.	Remarks
Fuse	FGMB 4A AC125V	000-119-976	Supplied as spare parts

6.3 Diagnostics

The NAVpilot-511 has a diagnostic function which checks the Processor unit, Control unit, Heading sensor, Keyboard, LCD and Rudder for proper operation.

To access a diagnostic function, do the following procedure:

1. Press the [TURN/MENU] key twice to show the menu.
2. Rotate the course control knob to select "TEST".
3. Press the course control knob to show the test options window.

OFF
PROCESSOR UNIT CONTROL UNIT HEADING SENSOR KEYBOARD TEST SCREEN TEST RUDDER TEST

Test options window

4. Rotate the course control knob to select an option.
5. Press the course control knob to start the diagnostic test.
6. Press the [MENU] key to finish.

PROCESSOR UNIT TEST

PROCESSOR UNIT	ID:2097151
ROM: OK	6454002-**. **
RAM: OK	EEPROM: OK
RUDDER ANGLE	OK 1°
BYPASS/CLUTCH	OK
REMOTECONT1	ON
REMOTECONT2	NOT USED
INPUT VOLTAGE	24.8 V
HEADING SENSOR:	--
PORT1/PORT2/RS232	-/- -/-

**. **: Program version no.

CONTROL UNIT TEST

CONTROL UNIT	
ROM: OK	6454003-**. **
RAM: OK	EEPROM: OK
COMMUNICATION:	OK
CONTROLLER ID:	255
CAN ID:	XXXXXXX
PUSH MENU KEY TO RETURN.	

**. **: Program version no.

HEADING SENSOR TEST

This test should be done while turning the connected sensor (PG-500) in a circle at a rate of 60°/min. or more. If the sensor does not rotate, this test terminates after one minute with NG result.

HEADING SENSOR	
ROM: OK	6454101-**. **
RAM: OK	EEPROM: OK
SENSOR: OK	
RATE SENSOR: OK	
TURN MORE THAN 180° IN 60 SECONDS.	
PUSH MENU KEY TO RETURN.	

**. **: Program version no.

KEYBOARD TEST

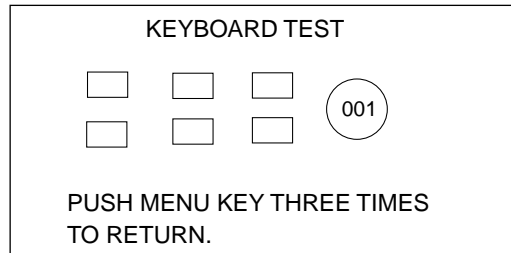

Operate each control on the control unit one by one. A key is functioning properly if its on-screen location lights in black when the key is pressed. For the course control knob, rotate it to show X-Y position; push it to confirm function.

To escape from the KEYBOARD TEST, press the [TURN/MENU] key three times.

SCREEN TEST

Each press of the course control knob changes the screen pattern in the sequence shown below.

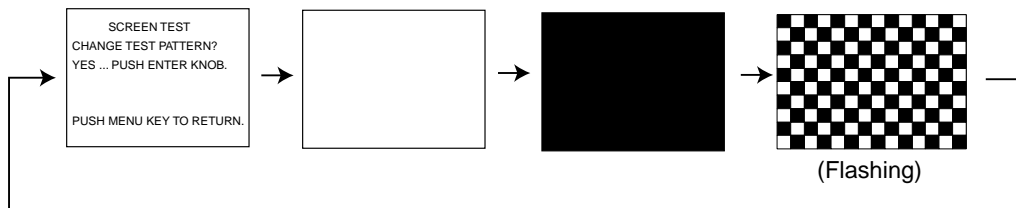

To escape from the SCREEN TEST, press the [MENU] key.

RUDDER SETUP AND AUTO TEST

The rudder test checks the following, and then shows the result of the check.

- Drive type
- The presence or absence of bypass/clutch circuit
- Rudder deadband
- Rudder speed
- Duty

This test should be executed when the boat does not run because of moving the rudder.

When the rudder test is finished, a beep sounds and the message “RUDDER TEST COMPLETED” and the results are shown.

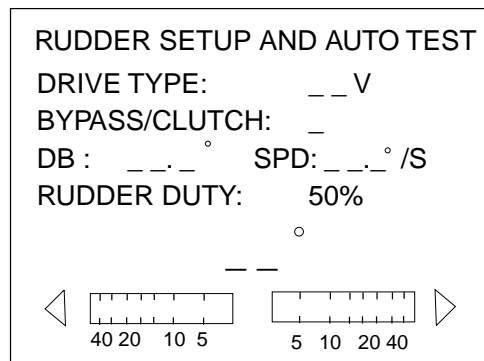
*Rudder test*

DRIVE TYPE: REVERSIBLE or SOLENOID

BYPASS/CLUTCH: EXIST or NON

DB: Shows the rudder deadband

SPD: Rudder speed

RUDDER DUTY: Rate of the rudder movement

SYSTEM DATA

You can confirm the current equipment and drive system status.

1. Press the [TURN/MENU] key twice to show the menu.
2. Rotate the course control knob to select "SYSTEM DATA".
3. Press the course control knob to show the system data screen.

SYSTEM DATA		ID: 1
INPUT VOLTAGE:	24.4 V	
CONTROLLER ID:	1	
DRIVE TYPE:	SOLENOID	
BYPASS/CLUTCH:	NON	
FET TEMP.:	24.6° F	
MOTOR DRIVE CUR.:	0.0 A	
BYPASS/CLUTCH CUR.:	0.0 A	

System data screen

6.4 Clearing Memories

Memories can be cleared to restore the Navpilot-511 to default settings. For details, see the installation manual.

6.5 Error Messages

In addition to alarm messages your equipment displays error messages to alert you of potential equipment trouble.

Error messages

Error message	Meaning	Remedy
COMMUNICATION ERROR	Communication between the control unit and the processor unit is interrupted for more than two seconds.	Check the interconnection cable between control unit and processor unit.
A SUDDEN POWER FAILURE HAS OCCURRED.	Power supply was interrupted for more than two seconds.	Press any key on the control unit.
RUDDER ANGLE ERROR	The rudder angle sent from the rudder reference unit exceeded 55°.	Check the drive motor, bypass valve/clutch.
RUDDER DRIVE ERROR	The rudder did not move more than 3° over 10 seconds after rudder command.	Check the hydraulic system. After the solving problem, do the rudder test.
DRIVE UNIT ERROR. PLEASE TURN OFF AND CHECK DRIVE CIRCUIT.	Current of more than 50 A was detected on the drive circuit without rudder command.	Check the bypass circuit.
DRIVE UNIT IS OVERLOADED. PLEASE TURN OFF AND CHECK DRIVE CIRCUIT.	Overcurrent was detected.	Check the drive circuit.
DRIVE UNIT IS OVERHEATED.	80°C temperature in drive unit was detected.	Check the drive unit system.
BYPASS/CLUTCH IS OVERLOADED.	Current of more than 1.6 A was detected on the bypass/clutch circuit.	Check the bypass/clutch circuit.
DISCONNECT B/C	No current on the bypass/clutch circuit.	
FU REMOTE CONTROLLER ERROR	Command from the FU remote controller exceeded 55°.	Check the remote controller connection.
MISSING HEADING DATA	The heading data from the heading sensor is missing for 600 ms.	Check the heading sensor and interconnection cable..
HEADING DATA ERROR	Heading data with error flag was detected three times continuously.	Check the heading sensor.
MISSING NAV DATA	The navigational data has been interrupted for more than 15 seconds.	Check the navigator.
DEGRADATION OF NAV DATA QUALITY	The navigation data was incomplete.	Check the navigator settings.
PARAMETER ERROR OF NAV MODE	The navigation data included an error flag.	

Continued on next page.

6. MAINTENANCE & TROUBLESHOOTING

Error messages (con't)

INPUT VOLTAGE IS OVER (UNDER) LIMIT	The input power source fluctuated beyond tolerance.	Check ship's mains.
MAGNETIC SENSOR ERROR RATE SENSOR ERROR	The heading data from the heading sensor was wrong.	Check the heading sensor.
NO CALIBRATION	Calibration not yet executed.	Ask your dealer to do the calibration.

MENU TREE

STBY mode menu

[MENU] key

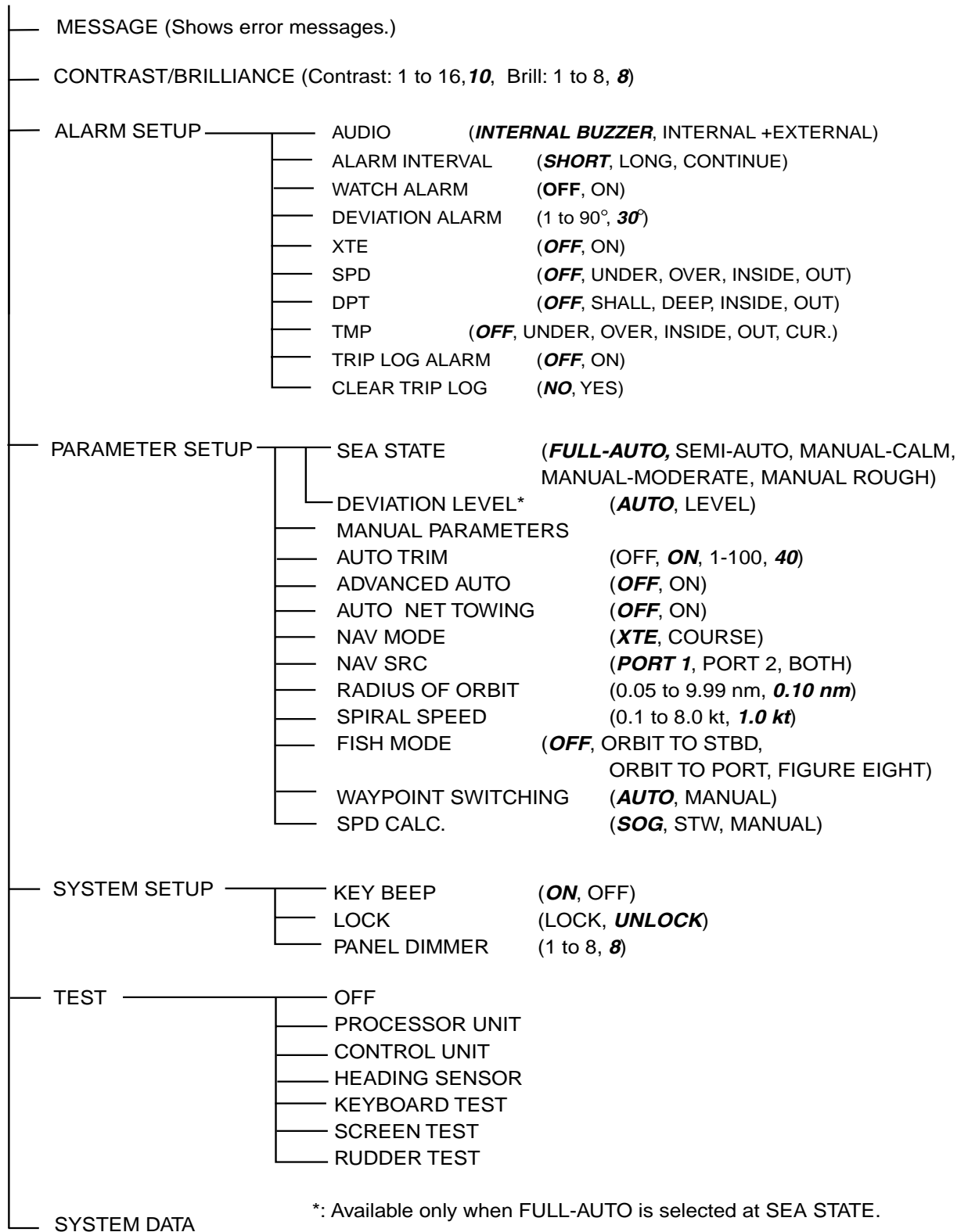

MENU TREE

AUTO mode menu

[MENU] key

—	MESSAGE (Shows error messages.)	
—	CONTRAST/BRILLIANCE (Contrast: 1 to 16, 10 , Brill: 1 to 8, 8)	
—	ALARM SETUP	See page MN-1.
—	ADVANCED AUTO	(OFF , ON)
—	SEA STATE	(FULL-AUTO , SEMI-AUTO, MANUAL-CALM, MANUAL-MODERATE, MANUAL ROUGH)
—	DEVIATION LEVEL*	(AUTO , LEVEL)
—	MANUAL PARAMETERS**	(WHEATHER; 1° to 10°, RUDDER GAIN; 0.1 to 2.0, COUNT RUDDER; 0.1 to 4.0)
—	AUTO TRIM	(OFF, ON , 1-100, 40)
—	AUTO NET TOWING	(OFF , ON)
—	SPD CALC.	(SOG , STW, MANUAL)
—	RADIUS OF ORBIT	(0.05 to 9.99 nm, 0.10 nm)
—	SPIRAL SPEED	(0.1 to 8.0 kt, 1.0 kt)
—	SYSTEM DATA	

*: Available only when FULL-AUTO is selected at SEA STATE.

**: Default settings are depends on ship's length and width entered on installing.

NAV mode menu

[MENU] key

—	MESSAGE (Shows error messages.)	
—	CONTRAST/BRILLIANCE (Contrast: 1 to 16, 10 , Brill: 1 to 8, 8)	
—	ALARM SETUP	See page MN-1.
—	NAV SRC	(PORT 1 , PORT 2, BOTH)
—	SEA STATE	(FULL-AUTO , SEMI-AUTO, MANUAL-CALM, MANUAL-MODERATE, MANUAL ROUGH)
—	DEVIATION LEVEL*	(AUTO , LEVEL)
—	MANUAL PARAMETERS**	(WHEATHER; 1 to 10, RUDDER GAIN; 0.1 to 2.0, COUNT RUDDER; 0.1 to 4.0)
—	AUTO TRIM	(OFF, ON , 1-100, 40)
—	WAYPOINT SWITCHING	(AUTO , MANUAL)
—	NAV MODE	(XTE , COURSE)
—	FISH MODE	(OFF , ORBIT TO STBD, ORBIT TO PORT, FIGURE EIGHT)
—	SPD CALC.	(SOG , STW, MANUAL)
—	RADIUS OF ORBIT	(0.05 to 9.99 nm, 0.10 nm)
—	SPIRAL SPEED	(0.1 to 8.0 kt, 1.0 kt)
—	SYSTEM DATA	

*: Available only when FULL-AUTO is selected at SEA STATE.

**: Default settings are depends on ship's length and width entered on installing.

SPECIFICATIONS OF AUTOPILOT NAVPILOT-511

1 CONTROL UNIT

- | | | |
|-----|-------------|---|
| 1.1 | Display | Monochrome LCD, 42 (W) x 83 (H) mm, 160x80 dots |
| 1.2 | Backlight | Adjustable in 8 steps |
| 1.3 | Contrast | 16 steps |
| 1.4 | Useable Set | 6 sets |

2 PROCESSOR UNIT

- | | | |
|-----|-------------------------|--|
| 2.1 | Rudder Mode | Manual, Auto, Dodge, Remote, Navigation* |
| 2.2 | Weather Adjustment | AUTO/CALM/MODERATE/ROUGH |
| 2.3 | Rudder Angle Ratio | AUTO/0-9 |
| 2.4 | Rudder Angle Equivalent | AUTO/0-9 |
| 2.5 | Rudder Angle Settings | 45° max. |
| 2.6 | Alarm | Bearing deviation, Out of course*, Watch, Ship's speed*,
Water temperature*, Depth*, Log* |
- *: Navigation data required

3 INTERFACE

- | | | |
|-----|-----------------------|--|
| 3.1 | Ports | Navigation data (NMEA): 1, Output (NMEA): 1
Input (NMEA): 1, I/O for Bearing Sensor (NMEA): 1 |
| 3.2 | Input Sentences | IEC 61162-1 ed1/2, IEC 61162-2, NMEA 0183 1.5/2.0/3.0 |
| | Command Bearing | APA, APB, BOD/XTE, RMB |
| | Ship's Location (L/L) | GGA, RMC, RMA, GLL |
| | Ship's Location (LOP) | GLC, GTD, RMA |
| | SOG/COG | VTG, RMC, RMA |
| | STW | VHW |
| | Heading (HDG) | HDT, HDG, HDM |
| | Destination | RMB, WPL |
| | Bearing/distance | RMB, BWC, BWR |
| | Time | RMC, ZDA |
| | Arrival Alarm | AAM, RMB |
| | Cross Track Error | APB, XTE, RMB |
| | Water Depth | DPT, DBT |
| | Water Temperature | MTW |
| | Wind Speed/Bearing | VPW, MWD, MWV |
| 3.3 | Output Sentences | NMEA 0183 1.5/2.0/3.0
GGA, RMA, RMC, GLC, GTD, VTG, VHW, WPL, BWC, BWR, ZDA,
AAM, APB, XTE, DPT, DBT, MTW, VPW, MWD, MWV |
| 3.4 | I/O Control | RS-232C |

FURUNO

5 POWER SUPPLY

3.1 Processor Unit 12-24 VDC: 3.0 A (excluding pump)

6 ENVIRONMENTAL CONDITIONS

4.1 Ambient Temperature -10°C to +55°C

4.2 Relative Humidity 95% at 40°C

6.3 Waterproof Processor unit: IPX2

Control unit, Rudder reference unit, Heading sensor,

Remote controller: IPX5

6.4 Vibration IEC 60945

7 COATING COLOR

5.1 Control Unit N3.0 (Gray)

5.2 Others 2.5GY5/1.5

INDEX

A	
ADVANCED AUTO mode	3-3
ALARM INTERVAL.....	5-2
AUDIO ALARM.....	5-2
AUTO mode.....	3-2
AUTO TRIM.....	4-7
ANALOG INDICATOR BAR.....	2-6
B	
Brilliance	2-3
C	
Contrast	2-3
COUNTER RUDDER	4-6
Course control knob	2-1
D	
Deviation alarm.....	5-3
Distance alarm.....	5-7
DODGE mode	3-20
F	
FIGURE EIGHT	3-7, 3-14
K	
KEY BEEP	4-10
L	
LOCK	4-11
N	
NAV mode.....	3-4
NET TOWING.....	4-8
Normal Display	2-4
O	
ORBIT.....	3-10
P	
PANEL DIMMER.....	4-12
Parameter	4-2
R	
REMOTE mode	3-16
RUDDER GAIN.....	4-5
S	
Sailing method.....	3-5
SEA STATE.....	4-2
Speed alarm.....	5-5
STBY mode	3-1
T	
Temperature alarm	5-7
Tests.....	6-2
TLL.....	3-15
W	
Waypoint.....	3-5, 3-6, 3-7
WATCH ALARM.....	5-3
WEATHER	4-6
X	
XTE alarm.....	5-4