

Basic Operation Guide

Notices.....	2
Introduction.....	4
Printer Parts and Control Panel Functions	5
Printer Parts	5
Control Panel.....	6
Loading Paper	7
Selecting Paper Type.....	7
Loading Paper in the Sheet Feeder	7
Storing Your Printouts	8
Accessing Images to Print	9
Inserting a Memory Card	9
Printing from a Digital Camera.....	10
Printing Photos	11
Printing several photos	11
Printing all photos.....	11
Printing an index sheet of photos.....	11
Camera-selected DPOF photos.....	11
Replacing Ink Cartridges.....	12
Maintenance and Transporting.....	14
Improving Print Quality	14
Cleaning the Printer	15
Transporting the Printer.....	16
Troubleshooting	17
Error Display List.....	17
Problems and Solutions.....	18
Customer Support	20
Appendix.....	21
Ink and Paper	21
Printer Specifications.....	21
Panel Icon List	23

Notices

Safety Instructions

Read all of the instructions in this section before using your printer. Also, be sure to follow all warnings and instructions marked on the printer.

When setting up your printer

- Do not block or cover the vents and openings in the printer.
- Use only the type of power source indicated on the printer's label.
- Use only the power cord that comes with this printer. Use of another cord may result in fire or electric shock.
- Be sure your AC power cord meets the relevant local safety standard.
- Do not use a damaged or frayed power cord.
- If you use an extension cord with the printer, make sure that the total ampere rating of the devices plugged into the extension cord does not exceed the cord's ampere rating. Also, make sure that the total ampere rating of all devices plugged into the wall outlet does not exceed the wall outlet's ampere rating.
- Do not attempt to service the printer yourself.
- Unplug the printer and refer servicing to qualified service personnel under the following conditions:

The power cord or plug is damaged; liquid has entered the printer; the printer has been dropped or the casing damaged; the printer does not operate normally or exhibits a distinct change in performance.

When choosing a place for the printer

- Place the printer on a flat, stable surface that extends beyond the base of the printer in all directions. If you place the printer by the wall, leave more than 10 cm between the back of the printer and the wall. The printer will not operate properly if it is tilted at an angle.
- When storing or transporting the printer, do not tilt it, stand it on its side, or turn it upside down. Otherwise, ink may leak from the cartridges.
- Avoid places subject to rapid changes in temperature and humidity. Also, keep the printer away from direct sunlight, strong light, or heat sources.

- Leave enough room around the printer to allow for sufficient ventilation.
- Place the printer near a wall outlet where the plug can be easily unplugged.

When using the printer

Take care not to spill liquid on the printer.

When using LCD panel

- The LCD panel may contain a few small bright or dark spots. These are normal and do not mean that they are damaged in any way.
- Only use a dry, soft cloth to clean the LCD panel. Do not use liquid or chemical cleansers.
- If the LCD panel on your printer's control panel is damaged, contact your dealer. If the liquid crystal solution gets on your hands, wash them thoroughly with soap and water. If the liquid crystal solution gets into your eyes, flush them immediately with water. If discomfort or vision problems remain after a thorough flushing, see a doctor immediately.

When handling the ink cartridges

- Keep ink cartridges out of the reach of children. Do not allow children to drink from or handle the cartridges.
- Do not shake the ink cartridges; this can cause leakage.
- Be careful when you handle used ink cartridges, as there may be some ink remaining around the ink supply port. If ink gets on your skin, wash the area thoroughly with soap and water. If ink gets into your eyes, flush them immediately with water. If discomfort or vision problems remain after a thorough flushing, see a doctor immediately.
- Do not remove or tear the label on the cartridge; this can cause leakage.
- Install the ink cartridge immediately after you remove it from its package. If you leave a cartridge unpacked for a long time before using it, normal printing may not be possible.
- Do not touch the green IC chip on the back of the cartridge. Doing so may prevent normal operation and printing.

ENERGY STAR® Compliance



As an ENERGY STAR Partner, Epson has determined that this product meets the ENERGY STAR guidelines for energy efficiency.

The International ENERGY STAR Office Equipment Program is a voluntary partnership with the computer and office equipment industry to promote the introduction of energy-efficient personal computers, monitors, printers, fax machines, copiers, scanners, and multifunction devices in an effort to reduce air pollution caused by power generation. Their standards and logos are uniform among participating nations.

Copyrights and Trademarks

No part of this publication may be reproduced, stored in a retrieval system, or transmitted in any form or by any means, electronic, mechanical, photocopying, recording, or otherwise, without the prior written permission of Seiko Epson Corporation. The information contained herein is designed only for use with this Epson printer. Epson is not responsible for any use of this information as applied to other printers.

Neither Seiko Epson Corporation nor its affiliates shall be liable to the purchaser of this product or third parties for damages, losses, costs, or expenses incurred by the purchaser or third parties as a result of accident, misuse, or abuse of this product or unauthorized modifications, repairs, or alterations to this product, or (excluding the U.S.) failure to strictly comply with Seiko Epson Corporation's operating and maintenance instructions.

Seiko Epson Corporation shall not be liable for any damages or problems arising from the use of any options or any consumable products other than those designated as Original Epson Products or Epson Approved Products by Seiko Epson Corporation.

Seiko Epson Corporation shall not be held liable for any damage resulting from electromagnetic interference that occurs from the use of any interface cables other than those designated as Epson Approved Products by Seiko Epson Corporation.

EPSON® is a registered trademark and EPSON STYLUS™ is a trademark of Seiko Epson Corporation.

PRINT Image Matching™ is a trademark of Seiko Epson Corporation. The PRINT Image Matching logo is a trademark of Seiko Epson Corporation.

USB DIRECT-PRINT™ is a trademark of Seiko Epson Corporation. The USB DIRECT-PRINT logo is a trademark of Seiko Epson Corporation.

Microsoft® and Windows® are registered trademarks of Microsoft Corporation.

Apple® and Macintosh® are registered trademarks of Apple Computer, Inc.

DPOF™ is a trademark of CANON INC., Eastman Kodak Company, Fuji Photo Film Co., Ltd. and Matsushita Electric Industrial Co., Ltd.

Zip® is a registered trademark of Iomega Corporation.

SD™ is a trademark.

Memory Stick, Memory Stick Duo, Memory Stick PRO, and Memory Stick PRO Duo are trademarks of Sony Corporation.

xD-Picture Card™ is a trademark of Fuji Photo Film Co., Ltd.

General Notice: Other product names used herein are for identification purposes only and may be trademarks of their respective owners. Epson disclaims any and all rights in those marks.

Copyright © 2005 Seiko Epson Corporation. All rights reserved.

Introduction

After you have set up your printer as described on the *Start Here* sheet, refer to this book to:

- Load paper
- Print photos stored on a memory card
- Print photos from a digital camera or an external storage device.
- Save photos from a memory card to an external device
- Perform routine maintenance
- Solve most problems

This book tells you how to do these things without ever turning on your computer! Of course your printer can do lots more when you connect it to your Windows® or Macintosh® computer.

For complete instructions on using the printer with your computer, see the on-screen *User's Guide*. An icon for the guide was automatically placed on your desktop when you installed the software.

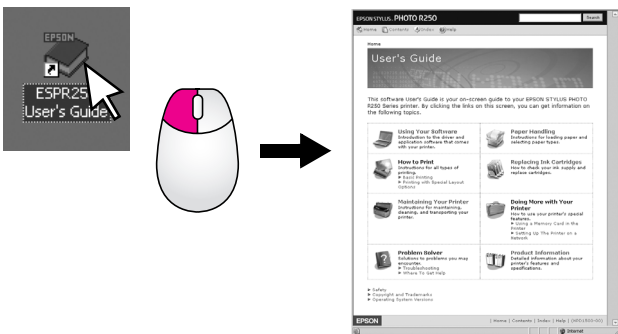



Please follow these guidelines as you read your instructions:

Warning:
Warnings must be followed carefully to avoid bodily injury.

Caution:
Cautions must be observed to avoid damage to your equipment.

Note:
Notes contain important information about your printer.

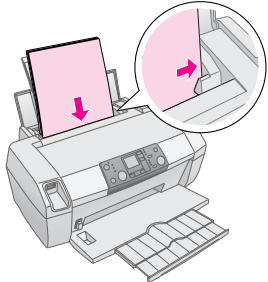
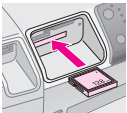
Basic Printing Procedure

<p>1. Load paper</p>	<p>Load paper printable side up, then fit the edge guide to the paper.</p> <p>See “Loading Paper in the Sheet Feeder” on page 7. for details.</p> 
<p>2. Insert a memory card</p>	<p>Insert your memory card to the appropriate slot. See “Inserting a Memory Card” on page 9.</p> 
<p>3. Select Photos</p>	<p>Select the photos you want to print.</p> <p>See “Printing all photos” and “Printing several photos” on page 11.</p>
<p>4. Select Paper Size</p>	<p>Select the paper size on the control panel.</p>
<p>5. Select Paper Type</p>	<p>Select the paper type on the control panel.</p>
<p>6. Print</p>	<p>Press the Start button.</p> 



Printer Parts and Control Panel Functions

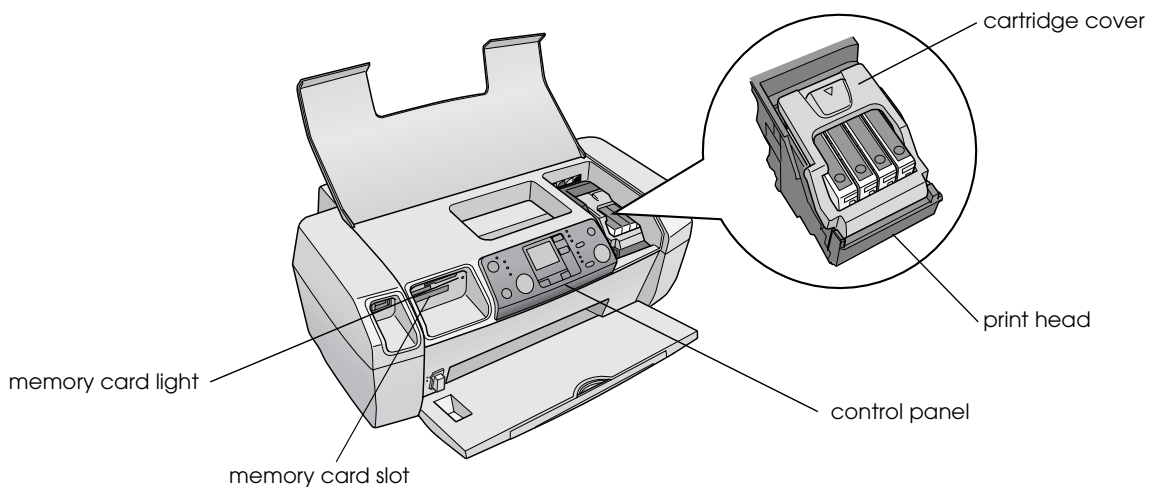
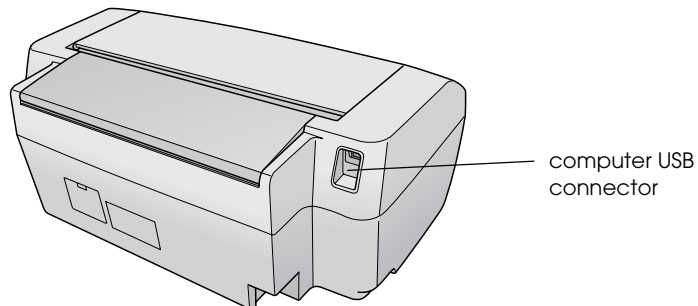
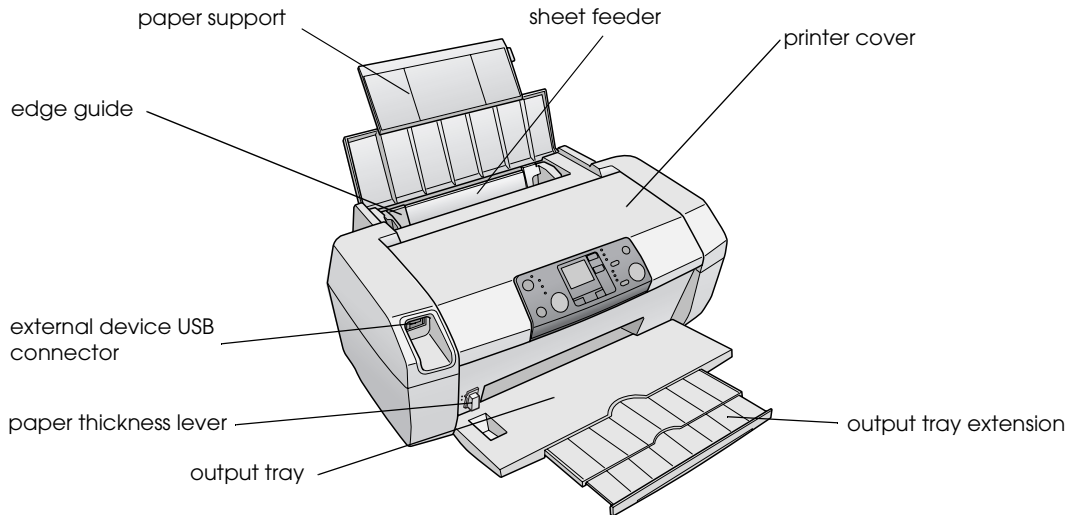

Printer Parts

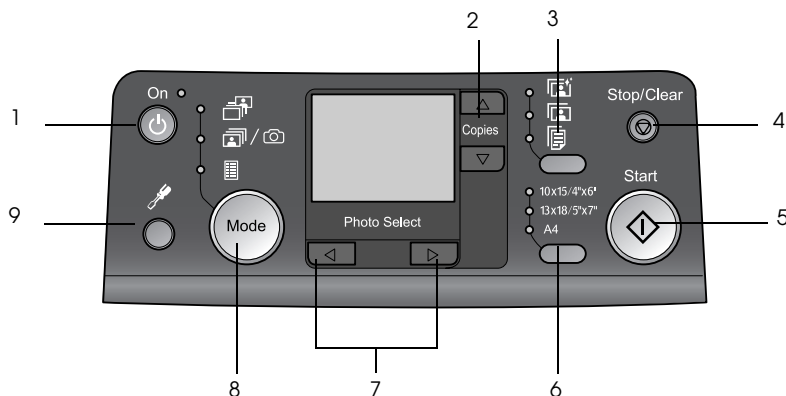

Control Panel



	Button	Function
1	On	Press to turn the printer on and off.
2	▲ ▼ Copies	Press to select the number of copies.
3	Paper type	Press to select the paper type.  Photo Paper: Epson Premium Glossy Photo Paper, Epson Premium Semigloss Photo Paper, Epson Ultra Glossy Photo Paper  Matte Paper: Epson Matte Paper-Heavyweight  Plain Paper: plain paper, Epson Bright White Ink Jet Paper
4	⊞ Stop/Clear	Press to stop printing, eject paper, or clear error status. When not printing, or reset the settings you have made.
5	◇ Start	Press to start printing with the settings made on the control panel. When in paper jam, press to eject the paper.
6	Paper size	Press to select 10 × 15 cm/4" × 6" , 13 × 18 cm/5" × 7" , or A4 , as the size of the paper set in the sheet feeder. You can only print on one of these sizes printing from a memory card directly.
7	◀ ▶ Photo/Options	Press to select the photo you want to print, or to select the setup and utility functions.

8	Mode	Press to print photos from a memory card. Select from the following. (Lights show which mode is selected.)  Print Select: Select this options to choose the photos you want to print.  Print All/PictBridge: Select this option to print all the photos on a memory card, or to print photos using the DPOF information stored on the memory card, or to print photos directly from a digital camera.  Index Sheet: Select this to print an index sheet of photos.
9	Setup	Press to display setup options.

Loading Paper

The type of paper you choose affects the way your printout looks, so be sure to select the correct paper for your job.

Selecting Paper Type

If you are just printing a rough draft of an photos, plain paper is fine. However, for the best results, you will want to use one of Epson's special ink jet papers.

For this paper	Select this Paper Type setting	Loading Capacity
Epson Premium Glossy Photo Paper	Photo Paper	Up to 20 sheets
Epson Premium Semigloss Photo Paper		
Epson Ultra Glossy Photo Paper		
Epson Matte Paper - Heavyweight	Matte Paper	
Plain Paper (Recycled Paper)	Plain Paper	Up to 100 sheets
Epson Bright White Ink Jet Paper		Up to 80 sheets

Loading Paper in the Sheet Feeder

Follow these steps to load paper.

1. Open the paper support, then raise the extension.

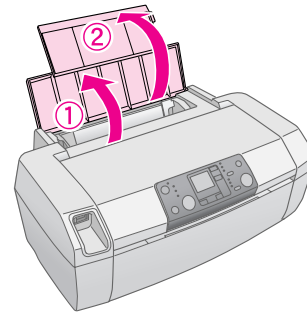

2. Lower the output tray, then slide out the extension.

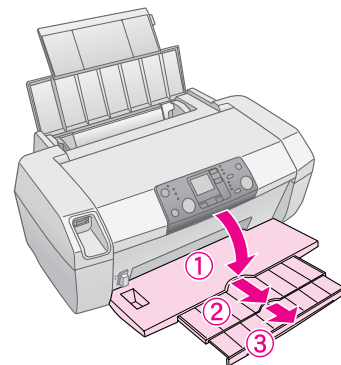

3. Slide the edge guide to the left.

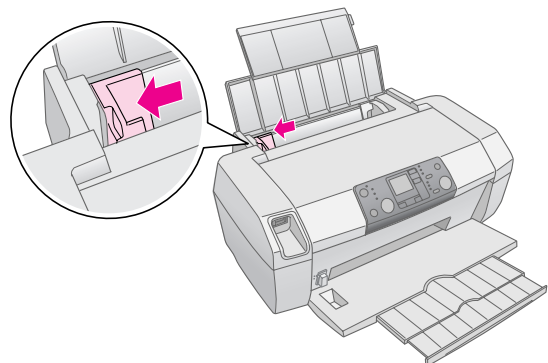

4. Fan a stack of paper, then tap it on a flat surface to even the edges.
5. Load the paper against the right side of the sheet feeder, with the printable side up. The printable side is usually whiter or glossier.

Place the stack of paper behind the tabs and make sure it fits under the \equiv arrow mark inside the left edge guide. Always load paper short edge first, even for landscape printing.

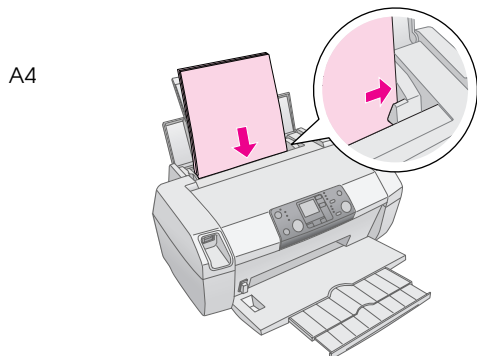

10 × 15 cm (4 × 6 in) and
13 × 18 cm (5 × 7 in)

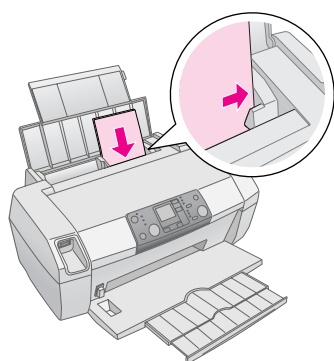

- Slide the edge guide against the left edge of the paper (but not too tightly).

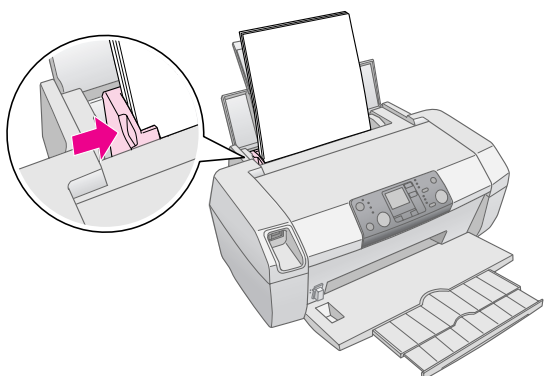

Note:

Leave enough space in front of the printer for the paper to be fully ejected.

Storing Your Printouts

With proper care, photographs from your printer will last for many years. The special Epson inks designed for your printer are formulated to achieve improved light fastness when used with Epson paper and the prints are properly displayed or stored.

As with traditional photos, proper care will minimize color changes and lengthen display life:

- For display, Epson recommends that prints be framed under glass or a protective plastic sleeve to protect them from atmospheric contaminants like humidity, cigarette smoke, and high levels of ozone.
- As with all photographs, keep your prints away from high temperatures and humidity and out of direct sunlight.
- For proper storage, Epson recommends that you keep prints in a photo album or plastic photo storage box in acid-free, archival sleeves commonly available at most camera stores.

Be sure to follow any other storage and display instructions included in the paper package.

Accessing Images to Print

Inserting a Memory Card

Caution:

- ❑ Insert a memory card so that the top of the card faces the right side, as shown in the illustration.
- ❑ Loading a memory card in ways other than those shown here may damage the printer, memory card, or both.
- ❑ Use only one type of memory card at a time. Eject the loaded memory card before inserting another kind of memory card.
- ❑ Close the printer cover when the memory card is in operation to protect the memory card from static electricity. If you touch the memory card when it is inserted in the printer, it may cause the printer to malfunction.
- ❑ Before loading the Memory Stick Duo, Memory Stick PRO Duo, miniSD Card, and MagicGate Memory Stick Duo, attach the adapter provided with it.

Inserting a Memory Card

1. Press the **On** button to turn on your printer.
2. Open the printer cover.

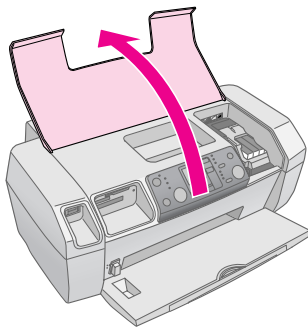

3. Insert the memory card as far as it can go into the appropriate slot as shown below. When it is in, the memory card light comes on.

Type of card	Slot
CompactFlash/ Microdrive	
Memory Stick/ Memory Stick PRO/ Memory Stick Duo*/ Memory Stick PRO Duo*/ MagicGate Memory Stick/ MagicGate Memory Stick Duo*/ SD Card/ miniSD Card*/ MultiMediaCard	
xD- Picture Card/ xD-Picture Card Type M/ SmartMedia	

* Requires an adapter

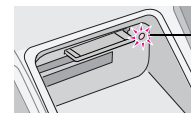

memory card light

4. Close the printer cover.

After a moment, the printer reads and counts the number of images on your card. When it has done, your images are available for printing (see page 11).

Removing a memory card

Make sure the memory card light is not flashing, then pull the card straight out of the slot.

Caution:

Do not remove a card while the memory card light is flashing; you may lose photos on your card.

Printing from a Digital Camera

PictBridge and USB Direct Print let you print your photos by connecting your digital camera directly to your printer.

1. Remove any memory cards from the printer. (If you leave a card inserted, photos will be read from it instead of the card in your camera.)
2. Load the type of paper you want to print on; ➔ page 7
3. Use the printer's control panel to select the paper type and paper size.
4. Connect the USB cable that came with your camera to the external device USB connector on the front of your printer.

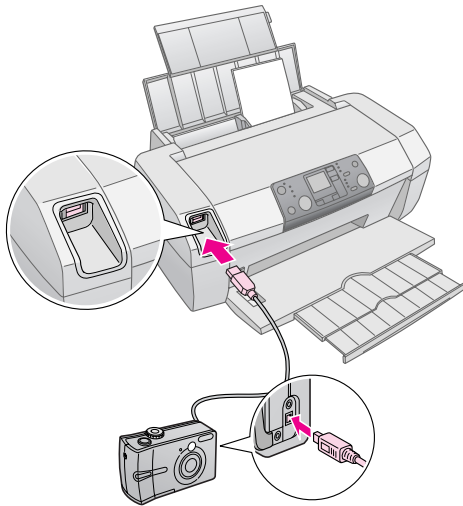

5. Make sure your camera is turned on. After a moment, the printer reads and counts your photos.
6. Use your camera to select the photos you want to print, adjust any necessary settings, and print your photos. See your camera's manual for details.

Note:

- If your camera is not compatible with PictBridge or USB Direct Print, this icon  appears on the LCD screen. Epson cannot guarantee the compatibility of any cameras.
- Some of the settings on your digital camera may not be reflected in the output.

Printing Photos

Printing several photos

1. Press the **Mode** button to select **Print Select**. The following screen appears.



2. Press the ◀ or ▶ **Photo/Options** button to view the photo you want to print.
3. Press the ▲ or ▼ **Copies** button to choose the number of copies to print for that photo (up to 99).



4. Repeat steps 2 and 3 for additional photos.
5. Press the paper type button to select the paper type.
For details, see "Selecting Paper Type" on page 7.
6. Press the paper size button to select the paper size.
7. Press the ◊ **Start** button to print.

Printing all photos

1. Press the **Mode** button to select **Print All/PictBridge**. The following screen appears.



2. Press the paper type button to select the paper type.
For details, see "Selecting Paper Type" on page 7.
3. Press the paper size button to select the paper size.
4. Press the ▲ or ▼ **Copies** button to choose the number of copies to print (up to 99).
5. Press the ◊ **Start** button to print.

Note:

If there is DPOF information on the memory card, you cannot print all of the photos on the card, even if **Print All/PictBridge** is selected. To print all of the photos on the memory card, cancel the DPOF information from your digital camera.

Printing an index sheet of photos

All photos in the memory card will be printed as thumbnails on A4 size paper. 20 photos will be printed on one sheet.

1. Load A4 plain paper to your printer.

Note:

You cannot print Index other than A4 size paper.

2. Press the **Mode** button to select **Index Sheet**. The printer automatically sets the paper type to Plain Paper and the paper size to A4. The following screen appears.

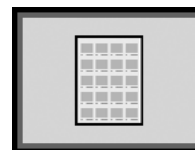

3. Press the ◊ **Start** button to print.

Camera-selected DPOF photos

If your camera supports DPOF (Digital Print Order Format), you can use it to pre-select which photos and how many copies you want to print. See your camera's manual to choose photos for printing with DPOF, then insert your memory card in your printer. The printer automatically reads your pre-selected photos.

1. Load paper and a memory card that contains DPOF data. Once a memory card has been loaded, the DPOF icon appears on the LCD panel and the Copies value becomes the number of copies you selected on your digital camera.



2. Press the ◊ **Start** button to start printing.

Replacing Ink Cartridges

Checking the ink supply

When the ink is low, this icon Δ appears in the upper-left of the LCD panel. Follow these steps to check your ink supply.

1. Press the **Setup** button.
2. Press the \blacktriangleleft or \blacktriangleright button to display **Check Ink Levels** , then press the \diamond **Start** button.

You see a graphic showing the amount of ink available in each cartridge.

Appears when ink is low.

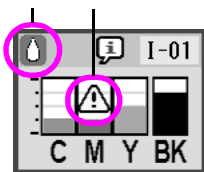

C (Cyan), **M** (Magenta), **Y** (Yellow), and **BK** (Black)

3. When you have done checking the ink levels, press the \diamond **Start** button.

When your ink starts getting low, make sure you have replacement cartridges available. You can not print if a cartridge is empty.

Precautions on ink cartridge replacement

Read all of the instructions in this section before replacing the ink cartridges.



Warning:

If ink gets on your hands, wash them thoroughly with soap and water. If ink gets in your eyes, flush them immediately with water. If you still have discomfort or vision problems, see a doctor immediately.

Caution:

- To avoid damaging the printer, never move the print head by hand.
- When an ink cartridge is empty, you cannot continue printing even if the other cartridges still contain ink.
- Leave the empty cartridge installed in the printer until you have obtained a replacement. Otherwise the ink remaining in the print head nozzles may dry out.
- To ensure good results, use genuine Epson ink cartridges and do not refill them. Other products not manufactured by Epson may cause damage that is not covered by Epson's warranties, and under certain circumstances, may cause erratic printer behavior.
- An IC chip on each ink cartridge accurately monitors the amount of ink used from the cartridge. Even if a cartridge is removed and then inserted again, all of its ink can be used. However, some ink is consumed each time the cartridge is inserted because the automatically checks its reliability.

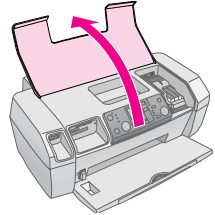
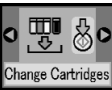
Replacing an ink cartridge

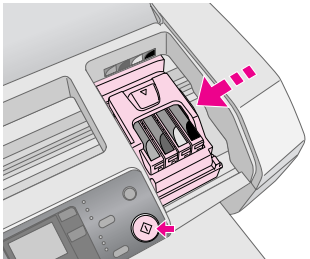
LCD	Steps
	<ol style="list-style-type: none"> 1. Make sure that the printer is on but not printing, then open printer cover. 
	<ol style="list-style-type: none"> 2. Do one of the following: <p>If an ink cartridge is empty: Look at the icon on the LCD panel to find out which cartridge is empty, then press the \diamond Start button.</p> <p>If an ink cartridge ink low: Check the ink levels. Then press the Setup button. Use the \blacktriangleleft or \blacktriangleright button to select Change Cartridges , then press the \diamond Start button. At the confirmation screen, press the \diamond Start button again.</p>
	<ol style="list-style-type: none"> 3. Press the \diamond Start button and open the printer cover. The ink cartridge moves slowly to the replacement position.  <p>Caution: Do not move the print head by hand, as this may damage the printer. Always press the \diamond Start button to move it.</p>

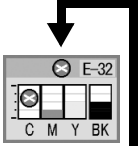
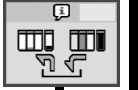
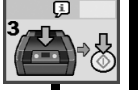
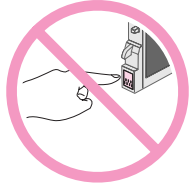
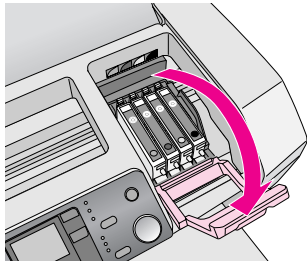
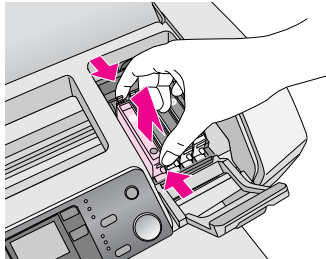
LCD	Steps
  	<p>4. Remove the new ink cartridge from the package.</p> <p>Caution:</p> <ul style="list-style-type: none"> ❑ Be careful not to break the hooks on the side of the ink cartridge when you remove it from the package. ❑ Do not remove or tear the label on the cartridge; otherwise, ink will leak. ❑ Do not touch the green IC chip on the front of the cartridge. This can damage the ink cartridge.  <ul style="list-style-type: none"> ❑ Be sure to always install an ink cartridge into the printer immediately following the removal of the current ink cartridge. If the ink cartridge is not installed promptly, the print head may dry out, rendering it unable to print.
	<p>5. Open the cartridge cover.</p> 
	<p>6. Pinch the sides of the ink cartridge that you want to replace. Lift the cartridge out of the printer and dispose of it properly. Do not take the used cartridge apart or try to refill it.</p> 

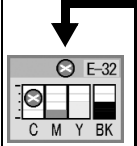
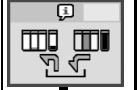
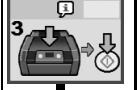
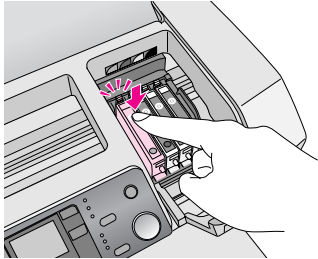
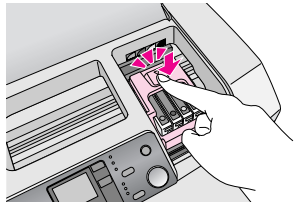
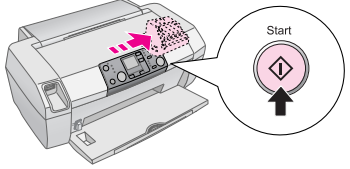
LCD	Steps
  	<p>7. Place the ink cartridge vertically into the cartridge holder. Then, push the ink cartridge down until it clicks into place.</p> 
	<p>8. When you have finished replacing the cartridge, close the cartridge cover and the printer cover.</p> 
	<p>9. Press the Start button. The print head will move and charging of the ink delivery system will begin. When the ink charging process is finished, the print head will return to its home position.</p>  <p>Caution: The On button continues to flash while the printer performs the ink charging operation. Never turn off the printer while this light is flashing. Doing so can result in incomplete charging of ink.</p> <p>Note: If the ink end error occurs after the print head moves to its home position, the ink cartridge may not be installed properly. Press the Stop/Clear button again, and reinstall the ink cartridge until it clicks into place.</p>

Maintenance and Transporting

Improving Print Quality



Cleaning the print head

If your printouts are unexpectedly light or faint, or dots or lines are missing, you may need to clean the print head. This unclogs the nozzles so they can deliver ink properly. Print head cleaning uses ink, so clean it only if quality declines.

⚠ Caution:

When you do not turn on your printer for a long time, the print quality can decline, so turn it on at least once a month to maintain good print quality.

Follow these steps to clean the print head from the printer's control panel:

1. Make sure the printer is turned on but not printing, and the ink low or ink end error is not displayed. If so, you may need to replace an ink cartridge; see page 12 for details.
2. Press the **Setup** button.
3. Press the ◀ or ▶ button to display **Clean Print Head** , then press the ⬠ **Start** button. The printer makes noise and cleaning takes about 30 seconds.
4. When cleaning is done, run a nozzle check to confirm the print head nozzles are clean. Make sure A4 plain paper is loaded in the printer, press the ▶ button to display **Check Ink Nozzles** , then press the ⬠ **Start** button.

⚠ Caution:

Do not turn off the printer or interrupt the cleaning process.

5. Examine the nozzle check pattern you printed. Each staggered horizontal and straight vertical line should be complete, with no gaps in the pattern, as shown below:



- If your printout looks okay, you are done. Press the Ⓞ **Stop/Clear** button to finish.
- If there are any gaps (as shown below), press the ⬠ **Start** button to clean the print head again.



If you do not see any improvement after cleaning three or four times, check the solutions beginning on page 18. You can also turn the printer off and wait overnight—this allows any dried ink to soften—and then try cleaning the print head again.

Aligning the print head

If your printouts contain misaligned vertical lines or horizontal banding, you may need to align the print head.

You can align the print head either from the printer's control panel or using your printer software.

Note:

For the best results, load A4 Epson Photo Quality Ink Jet Paper in the printer whenever you check the print head alignment.

1. Make sure the printer is turned on but not printing, and A4 paper is loaded.
2. Press the **Setup** button.
3. Press the ◀ or ▶ button to display **Align Print Head** , then press the ⬠ **Start** button.
4. The following alignment sheet is printed.

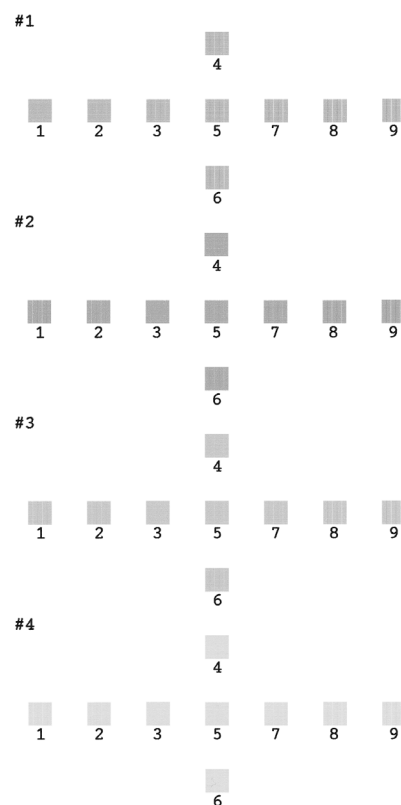

5. Look at the alignment pattern in each set and find the patch which is most evenly printed, with no noticeable streaks or lines.
6. Press the ▲ or ▼ button to highlight the number for the best pattern (1 to 9) in set #1, then press the ⬠ **Start** button.
7. Repeat step 6 to select the best pattern for sets #2, #3, and #4.
8. When you have finished, press the Ⓞ **Stop/Clear** button.

Cleaning the Printer

To keep your printer working at its best, you should clean it several times a year. Follow these steps:

1. Turn off the printer, unplug the power cord, and disconnect the printer cable.
2. Remove all paper, then use a soft brush to clean any dust or dirt from the sheet feeder.
3. Clean the exterior of the printer with a soft, damp cloth.
4. Use a soft, dry cloth to clean the LCD panel. Do not use liquid or chemical cleaners on the LCD panel.
5. If ink has spilled inside the printer, wipe it off only in the area shown below using a soft, damp cloth.

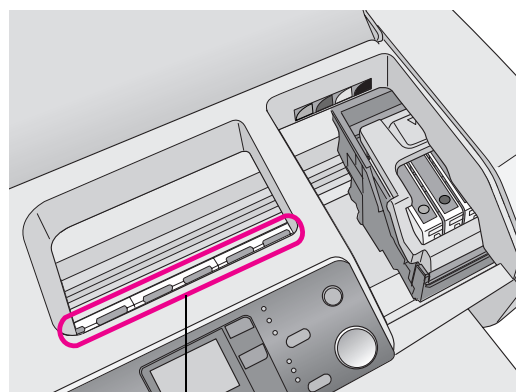

Clean here

⚠ Warning:

Do not touch the gears inside the printer.

⚠ Caution:

- Be careful not to wipe away lubricating grease inside the printer.
- Never use a hard or abrasive brush, or alcohol or thinner for cleaning; they can damage the printer components and case.
- Do not get water on the printer components and do not spray lubricants or oils inside the printer.
- Do not apply grease to the metal parts under the print head carriage.

Transporting the Printer

If you move your printer some distance, you need to prepare it for transportation in its original box or one of a similar size.

Caution:

To avoid damage, always leave the ink cartridges installed when transporting the printer.

1. Turn on the printer, wait until the print head locks in the far right position, then turn off the printer.
2. Unplug the power cord from the electrical outlet. Then disconnect the printer cable from the printer.
3. Remove any memory cards from the printer.
4. Remove any paper from the printer, push down the paper support extension, and close the paper support.
5. Open the printer cover. Secure the ink cartridge holder to the printer with tape as shown, then close the printer cover.

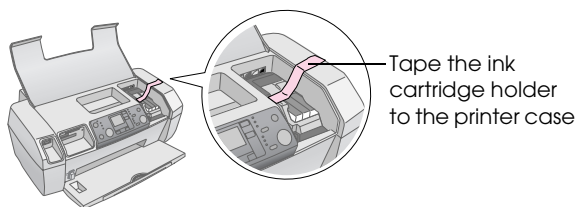

6. Push in the output tray extension and close the output tray.
7. Repack the printer and its attachments in the original box using the protective materials that came with them.

Keep the printer level as you transport it. After transporting the printer, remove the tape securing the print head and test your printer. If you notice a decline in print quality, clean the print head (see page 14); if output is misaligned, align the print head (see page 14).



Troubleshooting



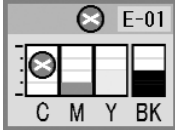
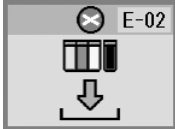
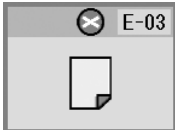
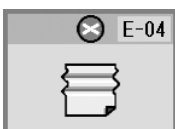
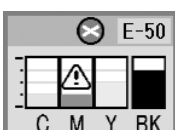

Error Display List

You can diagnose and solve most problems by checking the display on the LCD panel. If you cannot solve the problems by checking the display, use the following table and try the recommended solutions.

Note:

The solutions are for problems that happen when using this product stand alone. Refer to the online User's Guide for detailed solutions for computer-related problems.

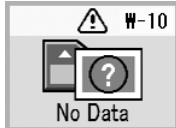
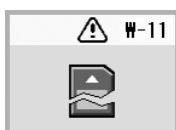
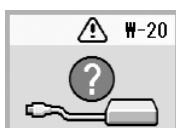
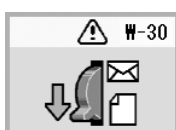
Display	Cause	Solution
	Ink out.	Replace with new ink cartridges. ➔ page 12
	Ink Cartridge is not installed.	Install the ink cartridge.
	No paper is loaded in the sheet feeder.	Load paper in the sheet feeder. Then press Start to continue or Stop/Clear to cancel. ➔ page 7
	Paper is jammed.	Clear paper jam, then press the Start button. ➔ page 19
	There is not enough ink in the cartridges to perform head cleaning.	Replace empty or low ink cartridges. ➔ page 12
	There is a problem with the printer.	Turn the printer off and then back on. If the error does not clear, contact your local authorized service center or contact Epson for a referral. ➔ page 20

	Waste ink pad saturated.	Contact your local authorized service center or contact Epson for a referral. ➔ page 20
	The waste ink pad is nearly saturated.	Contact your local authorized service center or contact Epson for a referral. ➔ page 20
	The memory card does not contain any valid data.	Remove the memory card and see ➔ page 9
	Memory card error.	Remove the memory card and see ➔ page 9
	The connected external device is not recognized	Check the connection and try again.
	Paper thickness lever is set to the wrong position.	Set the paper thickness lever to the correct position and try again.
	No memory card is inserted.	Insert a valid memory card and try again. ➔ page 9

Problems and Solutions

Print Quality Problems

You see banding (light lines) in your printouts or copies

- Make sure that the printable side of the paper is face up in the sheet feeder.
- Run the Head Cleaning utility to clear any clogged ink nozzles.
➔ See “Cleaning the print head” on page 14
- Run the Print Head Alignment utility.
➔ See “Aligning the print head” on page 14
- Use up ink cartridges within six months after opening their package.
- Check the LCD panel. If the Δ ink icon is displayed, replace the appropriate ink cartridges.
➔ See “Replacing Ink Cartridges” on page 12
- Make sure that the Paper Type selected on the control panel is appropriate for the type of paper loaded in the printer.

Your printout is faint or has gaps

- Run the Head Cleaning utility to clear any clogged ink nozzles.
➔ See “Cleaning the print head” on page 14
- Run the Print Head Alignment utility.
➔ See “Aligning the print head” on page 14
- Make sure that the Paper Type selected on the control panel is appropriate for the type of paper loaded in the printer.

You see wrong or missing colors

- Run the Head Cleaning utility.
➔ See “Cleaning the print head” on page 14
- If colors are still incorrect or missing, replace the color ink cartridges. If the problem persists, replace the black ink cartridge.
➔ See “Replacing Ink Cartridges” on page 12
- If you have just replaced an ink cartridge, make sure that the date on the box has not expired. Also, if you have not used the printer for a long time, replace the ink cartridges with new cartridges.
➔ See “Replacing Ink Cartridges” on page 12

Your printout is blurry or smeared

- Make sure that your paper is dry and that the printable side is face up.
- Make sure that the Paper Type setting on the control panel is correct.

- If you are printing on glossy media, place a support sheet (or a sheet of plain paper) beneath the stack, or load only one sheet at a time.
- Do not touch or allow anything to come into contact with the printed side of paper with a shiny finish. After printing documents on glossy media, allow the ink to set for a few hours before handling them.
- Run the Head Cleaning utility.
➔ See “Cleaning the print head” on page 14
- Run the Print Head Alignment utility.
➔ See “Aligning the print head” on page 14
- Feed paper and clean the roller inside.
➔ See “Using Paper Feed/Paper Eject function” on page 19
- If the problem persists, ink may have leaked inside the printer. In this case, wipe the inside of the printer with a soft, clean cloth.
➔ See “Cleaning the Printer” on page 15

Miscellaneous Printout Problems

Blank pages print

Run the Head Cleaning utility to clear any clogged ink nozzles.
➔ See “Cleaning the print head” on page 14

Smudges or blot appear on the printout

Feed paper and clean the roller inside.
➔ See “Using Paper Feed/Paper Eject function” on page 19

Paper Does Not Feed Correctly

Paper does not feed correctly or is jammed

- If paper does not feed, remove it from the sheet feeder. Fan the paper. Load it against the right side, and slide the left edge guide against the paper (but not too tightly). Do not load too many sheets at once (do not go past the \equiv arrow mark on the left edge guide) → page 7 for more information.
- If paper jams frequently, make sure the left edge guide is not pushed too tightly against the paper. Try loading fewer sheets of paper. The stack should never be above the \equiv arrow mark on the left edge guide. → page 7 for more information and follow the instructions that came with your paper.

You may also have pushed the paper down too far into the sheet feeder. Turn the power off and carefully remove the paper. Then reload the paper.

Printer Does Not Print

LCD panel is off

- Press the $\text{\textcircled{I}}$ **On** button to make sure that the printer is on.
- Turn off the printer and make sure that the power cord is securely plugged in.
- Make sure that your outlet works and is not controlled by a wall switch or timer.

LCD panel displays a warning or error message

If the LCD panel displays a warning or error, follow the instructions. See “Error Display List” on page 17 for an explanation of warnings and error messages.

LCD panel came on and then went out

The printer’s voltage may not match the outlet rating. Turn off the printer and unplug it immediately. Then, check the printer labels.

Caution:

If the voltage does not match, DO NOT PLUG YOUR PRINTER BACK IN. Contact your dealer.

Print head carriage problem

If the cartridge cover does not close or the print head carriage does not move to its home position, open the cartridge cover and push the ink cartridges down until they click into place.

Canceling Printing

If you encounter problems while printing, you may need to cancel printing.

To stop printing in progress, press the $\text{\textcircled{I}}$ **Stop/Clear** button. The printer will cancel all print jobs, stop printing, and eject any page that was printing. Depending on the printer’s status, printing may not stop immediately.

Using Paper Feed/Paper Eject function

1. Load several sheets of A4 size paper.
2. Press the **Setup** button to open the Setup menu.
3. Press the \blacktriangleleft or \blacktriangleright button to select **Paper Feed/Eject**.
4. Press the \diamond **Start** button to start to feed and eject the paper.
5. Repeat Step 4 if needed.
6. When you have finished, press the $\text{\textcircled{I}}$ **Stop/Clear** button.

Customer Support

Technical Support Web Site

Go to <http://www.epson.com> and select the Support section of your local EPSON web site for the latest drivers, FAQs, manuals and other downloadables.

Epson's Technical Support Web Site provides help with problems that cannot be solved using the troubleshooting information in your printer documentation. If you have a Web browser and can connect to the Internet, access the site at:

<http://support.epson.net/>

Contacting Customer Support

If your Epson product is not operating properly and you cannot solve the problem using the troubleshooting information in your product documentation, contact customer support services for assistance. Check your Pan-European Warranty Document for information on how to contact EPSON Customer support. They will be able to help you much more quickly if you give them the following information:

- Product serial number
(The serial number label is usually on the back of the product.)
- Product model

Ink and Paper

Ink

Cartridge	Part number
Black	T0551
Cyan	T0552
Magenta	T0553
Yellow	T0554

Paper

Epson offers specially designed media for ink jet printers to meet most high-quality printing needs.

The following media is for memory card printing only.

Paper name	Sizes	Part number
Epson Premium Glossy Photo Paper	A4	S041285, S041297
	10 × 15 cm	S041706, S041729, S041730, S041750
Epson Premium Semigloss Photo Paper	A4	S041332
Epson Bright White Ink Jet Paper	A4	S041442
Epson Matte Paper-Heavyweight	A4	S041258, S041259
Epson Ultra Glossy Photo Paper	A4	S041927

Note:

- The availability of special media varies by location.
- For the latest information on media available in your area, contact the Epson customer support web site.
 - ➔ See "Technical Support Web Site" on page 20

Printer Specifications

These specifications are only for standalone operation.

Printing

Printing method	On-demand ink jet
Nozzle configuration	Monochrome (black) 90 nozzles Color (cyan, magenta, yellow) 270 nozzles (90 × 3 colors)
Printable area	Border printing: 3-mm margin for all sides of paper Borderless printing: No margin

Paper

Note:

Since the quality of any particular brand or type of paper may be changed by the manufacturer at any time, Epson cannot attest to the quality of any non-Epson brand or type of paper. Always test samples of paper stock before purchasing large quantities or printing large jobs.

Paper specifications

Single sheet:

Size	A4 (210 × 297 mm), 10 × 15 cm (4 × 6 in.), 13 × 18 cm (5 × 7 in.)
Paper types	Plain bond paper, special paper distributed by Epson
Thickness (for plain bond paper)	0.08 to 0.11 mm (0.003 to 0.004 inch.)
Weight (for plain bond paper)	64 g/m ² (17 lb) to 90 g/m ² (24 lb)

Note:

- Poor quality paper may reduce print quality and cause paper jams or other problems. If you encounter problems, switch to a higher grade of paper.
- Use paper under normal conditions:
Temperature 15 to 25° C (59 to 77° F)
Humidity 40 to 60% RH

Ink Cartridge

Cartridge life	Within 6 months of opening the package, at 25°C [77°F]
Temperature	Storage: -20 to 40°C (-4 to 104°F) 1 month at 40°C (104°F)

Caution:

- ❑ Epson recommends the use of genuine Epson ink cartridges. Epson warranties do not cover damage to your printer caused by the use of ink cartridges not manufactured by Epson.
- ❑ Do not use an ink cartridge if the date on the package has expired.
- ❑ Do not refill the ink cartridge. The printer calculates the amount of ink remaining using an IC chip on the ink cartridge, so even if the cartridge is refilled, the IC chip will report that it is empty.

Printer

Sheet feeder capacity	About 100 sheets at 64 g/m ² (17 lb) paper
Dimensions	Storage Width: 436 mm (17.1 inches) Depth: 268 mm (10.6 inches) Height: 172 mm (6.8 inches) Printing Width: 436 mm (17.1 inches) Depth: 494 mm (19.4 inches) Height: 300 mm (11.8 inches)
Weight	5.0 kg (11.0 lb) without the ink cartridges

Electrical

	100-120 V Model	220-240 V Model
Input voltage range	90 to 132 V	198 to 264 V
Rated frequency range	50 to 60 Hz	
Input frequency range	49.5 to 60.5 Hz	
Rated current	0.4 A (Max.0.7 A)	0.2 A (Max.0.3 A)
Power consumption	Approx. 10 W (ISO10561 Letter Pattern) Approx.1.5 W in Sleep mode	Approx. 10 W (ISO10561 Letter Pattern) Approx.1.5 W in Sleep mode

Note:

Check the label on the back of the printer for the voltage of your printer.

Environmental

Temperature	Operation: 10 to 35°C (50 to 95°F)
Humidity	Operation: 20 to 80% RH

Compatible Memory Cards

See "Inserting a Memory Card" on page 9.

Note:

For the latest information on memory cards available for your printer, contact your dealer or regional Epson sales office.

Memory Card Data Format

Digital camera	DCF (Design rule for Camera File system) Version 1.0 or 2.0 compliant.
File format	JPEG, DOSFAT (FAT 12 or 16, one partition) taken with a DCF compliant digital camera. Supports Exif Version 2.21.
Image size	80 × 80 to 9200 × 9200 pixels
Number of files	Up to 999.

Note:

File names containing double-byte characters are not valid when printing directly from a memory card.

Standards and Approvals

European model:

Low Voltage Directive 73/23/EEC	EN 60950
EMC Directive 89/336/EEC	EN 55022 Class B EN 55024 EN 61000-3-2 EN 61000-3-3







Australian model:

EMC	AS/NZS CISPR22 class B
------------	------------------------

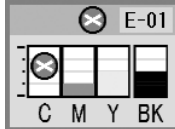
Panel Icon List

Printer errors and conditions are displayed with image icons and numerical codes. For details on solving the errors, see “Error Display List” on page 17.

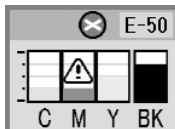

Error List

Display	Meaning
	Ink out.
	Install the ink cartridge.
	Paper out. Load paper.
	Clear paper jam, then press the Start button.
	There is not enough ink in the cartridges to perform a head cleaning. Replace empty or low ink cartridges.
	Call for service.
	Waste ink pad saturated. Call for service.

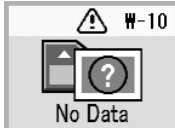
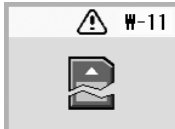
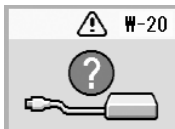
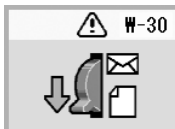



Warning Display

Display	Meaning
	Waste ink pad is nearly saturated. Call for service.
	Not photo data in memory card.
	Memory card error.
	Cannot recognize camera. Check connection.
	Paper thickness lever was changed.



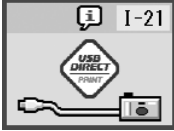

Icon List

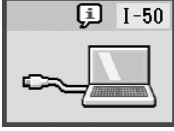
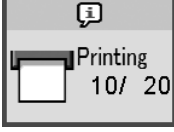
Display	Meaning
	The photo data includes P.I.F. data.
	Ink is low.

Information Display

Display	Meaning
	No memory card.
	Processing.
	PictBridge Camera connected.
	USB Direct Print Camera connected.
	Set the paper thickness lever to envelope position.
	Set the paper thickness lever to cut sheet position.
	PC connected.
	Printing.

Menu List

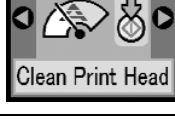
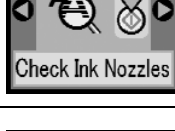
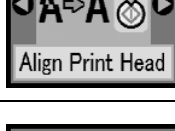
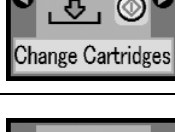
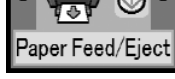
Display	Meaning
	Print all photos. ➔ See page 11
	Print Index Sheet. ➔ See page 11
	DPOF file found. Press the Start button to start printing. ➔ See page 11
	Check Ink Levels. Press the Start button to enter this mode. ➔ See page 12
	Clean Print Head. Press the Start button to enter this mode. ➔ See page 14
	Check Ink Nozzles Press the Start button to enter this mode. ➔ See page 14
	Align Print Head Press the Start button to enter this mode. ➔ See page 14
	Change Cartridges Press the Start button to enter this mode. ➔ See page 12
	Feed and Eject paper. Press the Start button to enter this mode. ➔ See page 19

