

EPSON®

Photo Printer

PictureMate 500

No part of this publication may be reproduced, stored in a retrieval system, or transmitted in any form or by any means, electronic, mechanical, photocopying, recording, or otherwise, without the prior written permission of Seiko Epson Corporation. The information contained herein is designed only for use with this Epson printer. Epson is not responsible for any use of this information as applied to other printers.

Neither Seiko Epson Corporation nor its affiliates shall be liable to the purchaser of this product or third parties for damages, losses, costs, or expenses incurred by the purchaser or third parties as a result of accident, misuse, or abuse of this product or unauthorized modifications, repairs, or alterations to this product, or (excluding the U.S.) failure to strictly comply with Seiko Epson Corporation's operating and maintenance instructions.

Seiko Epson Corporation shall not be liable for any damages or problems arising from the use of any options or any consumable products other than those designated as Original Epson Products or Epson Approved Products by Seiko Epson Corporation.

Seiko Epson Corporation shall not be held liable for any damage resulting from electromagnetic interference that occurs from the use of any interface cables other than those designated as Epson Approved Products by Seiko Epson Corporation.

EPSON® is a registered trademark and PictureMate™ is a trademark of Seiko Epson Corporation.

PRINT Image Matching™ and the PRINT Image Matching logo are trademarks of Seiko Epson Corporation.

Copyright © 2001 Seiko Epson Corporation. All rights reserved. USB DIRECT-PRINT™ and the USB DIRECT-PRINT logo are trademarks of Seiko Epson Corporation.

Copyright © 2002 Seiko Epson Corporation. All rights reserved. Microsoft® and Windows® are registered trademarks of Microsoft Corporation.

Apple® and Macintosh® are registered trademarks of Apple Computer, Inc.

Part of the photo data stored on the Printer Software CD-ROM is licensed from Design Exchange Co., Ltd. Copyright © 2000 Design Exchange Co., Ltd. All rights reserved.

DPOF™ is a trademark of CANON INC., Eastman Kodak Company, Fuji Photo Film Co., Ltd. and Matsushita Electric Industrial Co., Ltd. The *Bluetooth* word mark and logos are owned by the Bluetooth SIG, Inc. and any use of such marks by Seiko Epson Corporation is under license.

Zip® is a registered trademark of Iomega Corporation.

SD™ is a trademark.

Memory stick, Memory Stick Duo, Memory Stick PRO, and Memory Stick PRO Duo are trademarks of Sony Corporation.

xD-Picture Card™ is a trademark of Fuji Photo Film Co., Ltd.

General Notice: Other product names used herein are for identification purposes only and may be trademarks of their respective owners. Epson disclaims any and all rights in those marks.

Copyright © 2005 Seiko Epson Corporation. All rights reserved.

Get to Know Your PictureMate

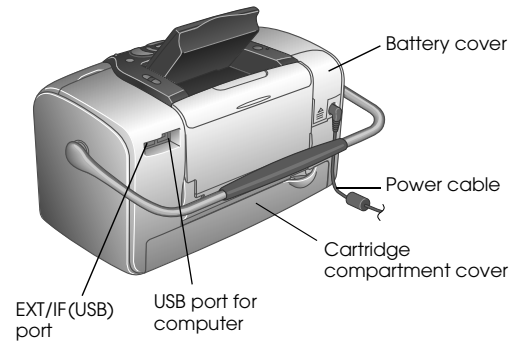
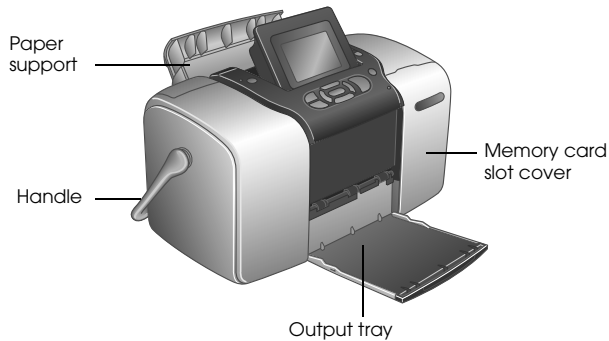
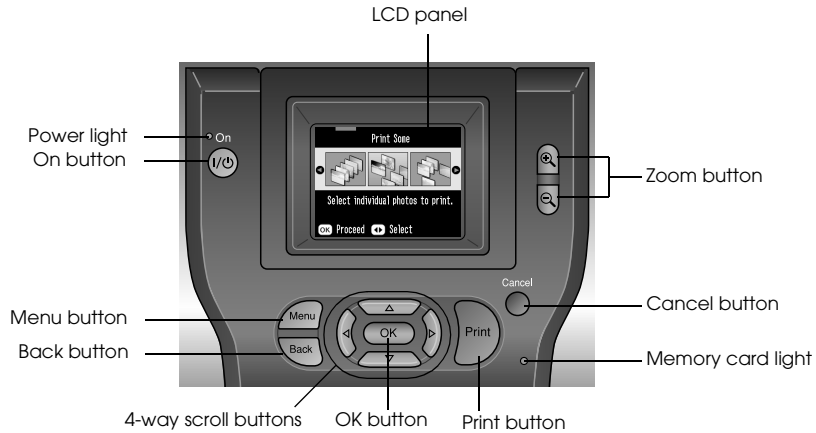

Contents

Safety Instructions

Important Safety Instructions	6
Warnings, Cautions, and Notes	13

Welcome!

A Quick Introduction to the Digital Photography Process	14
Supported Photo Formats	16
Where to Find Information	16

Preparing to Print

Loading Paper	17
Paper Handling Instructions	18
Inserting Your Memory Card	19

Basic Photo Printing

Printing All Photos	22
Printing Several Photos	22
Printing Range of Photos	23

Printing Photos Searching by Date	24
Printing an Index	25
Printing a Photo With a Frame	25
Printing Camera-Selected DPOF Photos	27

Doing More With Your Photos

Choosing a Layout	28
Adding the Date or Time	29
Printing Photos in Black and White or Sepia	31
Cropping Your Photo	32
Fixing Your Photos	33
Printing a Photo With a Frame Specified by Camera	36
Viewing a Slide Show	36

Saving Your Photos to an External Device

Saving Photos to an External Device	37
---	----

Printing From an External Device

Printing From an External Drive	40
Printing From a PictBridge-Enabled Camera	42

Printing From a Bluetooth Device	44
--	----

Replacing the Photo Cartridge

Checking the Photo Cartridge Status (Ink Level)	50
Replacing the Photo Cartridge	50

Taking PictureMate With You

Setting PictureMate Preferences

Changing the View of Photos on the LCD Screen	58
Setting the After Print Confirmation	59
Adjusting the LCD Screen Contrast	60
Selecting the Language on the LCD Screen	60
Changing the Default Settings	61
Resetting All Print Settings	61

Using PictureMate With a Computer

Installing the Printer Software	62
---	----

Maintaining PictureMate

Checking the Print Head Nozzles	65
Cleaning the Print Head	66

Aligning the Print Head	67
Cleaning the Printer	70

Troubleshooting

Error/Warning Messages	71
Printer Power Problems	73
Print and Noise Problems	74
Photo Quality Problems	75
Problems With Paper Feeding	76
Miscellaneous Printout Problems	77

Customer Support

Contacting Customer Support	78
Technical Support Web Site	78

Options and Consumable Products

Options	79
Consumable Products	79
Using the Optional Battery	80

Printer Specifications

Printer Specifications	83
----------------------------------	----

Safety Instructions

Important Safety Instructions

Read all of the instructions in this section before using your printer. Also, be sure to follow all warnings and instructions marked on the printer.

When choosing a place for the printer

Observe the following when choosing a place for the printer:

- ❑ Place the printer on a flat, stable surface that extends beyond the base of the printer in all directions. If you place the printer by the wall, leave more than 10 cm between the back of the printer and the wall. The printer will not operate properly if it is tilted at an angle.
- ❑ When storing or transporting the printer, do not tilt it, stand it on its side, or turn it upside down. Otherwise, ink may leak from the cartridge.
- ❑ Leave enough space in front of the printer for the paper to be fully ejected.
- ❑ Avoid places subject to rapid changes in temperature and humidity. Also, keep the printer and the AC adapter away from direct sunlight, strong light, water, or heat sources.
- ❑ Do not leave the printer in a place subject to high temperature, such as in a car. Also, keep the printer away from direct sunlight, strong light, and heat sources. Otherwise, the printer may be damaged or ink may leak.
- ❑ Avoid places subject to dust, shock, or vibration.
- ❑ Leave enough room around the printer to allow for sufficient ventilation.
- ❑ Place the AC adapter near a wall outlet where the plug can be easily unplugged.
- ❑ Do not place or store the printer, the AC adapter, or the optional battery outdoors.

When setting up your printer

Observe the following when setting up the printer:

- ❑ Do not block or cover the vents and openings in the printer.
 - ❑ Power supply cords should be placed to avoid abrasions, cuts, fraying, crimping, and kinking. Do not place objects on top of power-supply cords and do not allow the AC adapter or power-supply cords to be stepped on or run over. Be particularly careful to keep all power-supply cords straight at the ends and the points where they enter and leave the AC adapter.
 - ❑ Use only the power-supply cords that comes with this product. Use of another cord may result in fire or electrical shock, or injury.
 - ❑ The AC adapter model A361H is designed for use with the printer with which it was included. Do not attempt to use it with other electronic devices unless specified.
- ❑ Use only the type of power source indicated on the AC adapter's label, and always supply power directly from a standard domestic electrical outlet with the AC power cord that meets the relevant local safety standards.
 - ❑ Avoid using outlets on the same circuit as photocopiers or air control systems that regularly switch on and off.
 - ❑ Avoid using electrical outlets controlled by wall switches or automatic timers.
 - ❑ Keep the entire computer system away from potential sources of electromagnetic interference, such as loudspeakers or the base units of cordless telephones.
 - ❑ Do not use a damaged or frayed power cord, AC adapter, and the optional battery.
 - ❑ If you use an extension cord with the printer, make sure that the total ampere rating of the devices plugged into the extension cord does not exceed the cord's ampere rating. Also, make sure that the total ampere rating of all devices plugged into the wall outlet does not exceed the wall outlet's ampere rating.

- ❑ Never disassemble, modify, or attempt to repair the AC adapter, power cord, printer, and options by yourself except as specifically explained in the printer's guides.
- ❑ Unplug the printer and the AC adapter, remove the optional battery from the printer, and refer servicing to qualified service personnel under the following conditions:

The power cord or plug is damaged; liquid has entered the printer, the AC adapter, or the optional battery; the printer, the AC adapter or the optional battery has been dropped or the casing damaged; the printer, the AC adapter or the optional battery does not operate normally or exhibits a distinct change in performance. (Do not adjust controls that are not covered by the operating instructions.)

- ❑ Do not use with wet hands.
- ❑ If you plan to use the AC adapter or the optional battery in Germany, the building installation must be protected by a 10 or 16 amp circuit breaker to provide adequate short-circuit protection and over-current protection for this printer.

For United Kingdom, Singapore, and Hong Kong users

- ❑ Replace fuses only with fuses of the correct size and rating.

Safety requirements

Mains plug:

Use a 3-pin mains plug that is registered with the Safety Authority.

Flexible cord:

Use a double insulated flexible cord that is certified* to the relevant IEC or BS standards.

Appliance connector:

Use an appliance connector certified* to the relevant IEC or BS Standards.

* certified by member of IECEE CB Scheme.

For United Kingdom users

The following safety information applies to the AC adapter.

- ❑ Warning: Refer to the rating plate for the voltage and check that the appliance voltage corresponds to the supply voltage.

- ❑ Important: The wires in the mains lead fitted to this appliance are coloured in accordance with following code: Blue - Neutral, Brown - Live

If you have to fit a plug:

- ❑ As the colours of the mains lead of the appliance may not match the coloured markings used to identify the terminals in a plug, please observe the following:
- ❑ The blue wire must be connected to the terminal in the plug marked with the letter N.
- ❑ The brown wire must be connected to the terminal in the plug marked with the letter L.
- ❑ If damage occurs to the plug, replace the cord set or consult a qualified electrician.

When using the printer

Observe the following when using the printer:

- ❑ If you use the printer in places where the use of electronic devices is limited, such as in airplanes or hospitals, follow all instructions in those places.

- ❑ Do not insert objects through the slots in the printer.
- ❑ Take care not to spill liquid on the printer and the AC adapter.
- ❑ Do not put your hand inside the printer or touch the photo cartridge during printing.
- ❑ Always turn the printer off using the On button. Do not unplug the printer or turn off the power to the outlet until the power light goes out.
- ❑ Before transporting the printer, make sure that the photo cartridge is in place.
- ❑ Leave the photo cartridge installed. Removing the cartridge can dehydrate the print head and may prevent the printer from printing.

When using a memory card

- ❑ Use only memory cards compatible with the printer. Refer to Loading Memory Cards.

When using LCD

- ❑ The LCD panel contains a few small bright or dark spots. These are normal and do not mean that the LCD monitor is damaged in any way.
- ❑ Only use a dry, soft cloth to clean the LCD panel. Do not use liquid or chemical cleansers.
- ❑ If the LCD panel on your printer's control panel is damaged, contact your dealer. If the liquid crystal solution gets on your hands, wash them thoroughly with soap and water. If the liquid crystal solution gets into your eyes, flush them immediately with water. If discomfort or vision problems remain after a thorough flushing, see a doctor immediately.

When using the optional Bluetooth Photo Print Adapter

Refer to the Bluetooth Photo Print Adapter's documentation for the safety instructions.

When using the optional battery

- ❑ If battery acid gets into your eyes or on your skin, immediately rinse the affected area thoroughly with water and seek medical treatment. If a battery is swallowed, seek medical treatment immediately.
- ❑ Use only an Epson Li-ion battery model EU-112 for this printer according to the directions in the user documentation. Replacing the battery with an incorrect model may cause an explosion.
- ❑ Use only AC adapter model A361H to charge the battery and operate the printer.
- ❑ Do not charge or use the battery with devices other than the specified product. Using the battery with other devices may damage the battery or other devices, or may cause an explosion.
- ❑ To protect against short circuits, do not remove the outside case of the battery.
- ❑ Do not handle the battery with wet hands or use them near water.

- ❑ Do not expose the battery to water or high humidity.
- ❑ Do not drop, puncture, disassemble, mutilate, or short-circuit the battery.
- ❑ Do not place the battery near or into fire or water.
- ❑ Do not use the battery that is leaking or damaged in any way.
- ❑ Do not charge the battery on devices except this product.
- ❑ Do not charge the battery near open flame or in very hot locations.
- ❑ Keep the battery away from heat sources.
- ❑ Do not leave the battery in a vehicle to prevent the battery from overheating.
- ❑ Do not insert objects into any openings as they may touch dangerous voltage points or short-circuit components.
- ❑ Prevent the battery from coming into contact with metal objects that could short-circuit it, such as coins or keys.
- ❑ Do not solder wires or terminals directly to the battery.
- ❑ Do not touch battery terminals.
- ❑ Keep the battery away from open flame if they leak or smell strange.
- ❑ If overheating, discoloration, or deformation occur, remove the battery from this product and do not use it.
- ❑ Charge the battery before using it if it has not been used for a long period.

When storing the optional battery

- ❑ When not using the printer for a long period of time, remove the battery from the printer and store them separately to avoid over-discharging the battery.
- ❑ Do not store the battery where the temperature or humidity is very high.
- ❑ Store the battery out of children's reach.

When disposing of the optional battery

Before disposing of the battery, make sure you discharge them completely.



Warning:

- ❑ *Do not dispose of batteries as ordinary refuse. Instead, dispose of them in a collection or recycle box in accordance with local laws.*
- ❑ *Do not incinerate or dispose of the battery in fire.*

For European users:

Do not dispose of batteries as ordinary refuse. Instead, dispose of them in a recycle box in accordance with local laws.

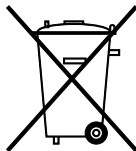

For users in the United States and Canada:



This mark indicates that the battery will be recycled by RBRC. When you dispose of the battery, contact RBRC.

When handling photo cartridges

Observe the following when handling photo cartridges:

- ❑ Do not shake photo cartridge after removing it from the bag; this can cause leakage.
- ❑ Do not remove or tear the label on the cartridge; this can cause leakage.
- ❑ Do not use a photo cartridge beyond the date printed on the cartridge carton: otherwise, it may result in reduced print quality. For best results, use up the photo cartridge within six months of installing it.
- ❑ Do not dismantle photo cartridges or try to refill them. This could damage the print head.

- ❑ After bringing a photo cartridge inside from a cold storage site, allow it to warm up at room temperature for at least three hours before using it.
- ❑ Store photo cartridges in a cool, dark place.
- ❑ The IC chip on the photo cartridge retains a variety of cartridge-related information, such as the amount of ink remaining, so that the cartridge may be removed and reinstalled freely. However, each time the cartridge is inserted, some ink is consumed because the printer automatically performs a reliability check.
- ❑ Store each photo cartridge so that the bottom of its packaging faces down.

ENERGY STAR® Compliance



As an ENERGY STAR® Partner, Epson has determined that this product meets the ENERGY STAR® guidelines for energy efficiency.

The International ENERGY STAR® Office Equipment Program is a voluntary partnership with the computer and office equipment industry to promote the introduction of energy-efficient personal computers, monitors, printers, fax machines, copiers, scanners, and multifunction devices in an effort to reduce air pollution caused by power generation. Their standards and logos are uniform among participating nations.

Warnings, Cautions, and Notes



Warnings

must be followed carefully to avoid bodily injury.



Cautions

must be observed to avoid damage to your equipment.

Notes

contain important information and useful tips on the operation of your printer.

Welcome!

PictureMate™ is your easy-to-use, personal photo lab. Just insert a digital camera memory card and you're ready to print brilliant, long-lasting photos. Because PictureMate is light and portable, you can print whenever and wherever you take pictures. Plus, your PictureMate photos are archival; generations from now your PictureMate prints will be as vibrant as they are today.

A Quick Introduction to the Digital Photography Process

With film cameras, the process was simple; buy film, take pictures, leave the film at the photo lab, and come back later for your photos and negatives. Since you had negatives, you could take them back later if you wanted reprints.



The digital process is simple too, and it gives you complete control. Just follow these basic steps:

1. Review and Delete

After you finish taking your photos, review them on your digital camera's screen. Delete the photos you don't want to print or keep.



2. Print

Insert your camera's memory card in PictureMate, choose your photos, and print.



3. Save

To preserve your digital photo files (just like film negatives), save them to a CD or your computer. Then you can reprint them any time.

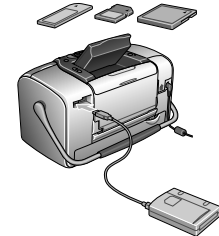

4. Clear the Memory Card

After you save your photo files, delete them from your memory card so you have room for more photos.

Special Features

Printing with your PictureMate becomes even easier with these special features:

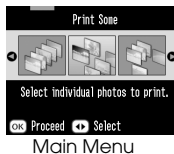

From the PictureMate Main Menu, you can print all your photos or you can select just the ones you want. See “Basic Photo Printing” on page 21.



You can crop photos right from PictureMate—no computer required. See “Cropping Your Photo” on page 32.



DPOF

If your camera supports DPOF (Digital Print Order Format), you can pre-select which photos to print while the memory card is still in your camera. Then, when you insert the card into PictureMate, it

knows which photos you chose. See “Printing Camera-Selected DPOF Photos” on page 27.



If you have a PictBridge®- or USB DP (USB Direct Print)-enabled camera, you can connect the camera to PictureMate and control printing right from your camera.

See “Printing From a PictBridge-Enabled Camera” on page 42.



If you have a Bluetooth®-enabled PDA, cell phone, or computer, you can send photos wirelessly to PictureMate for printing. You just need the optional Epson®

Bluetooth Photo Print Adapter. See “Printing From a Bluetooth Device” on page 44.

Note:

PictureMate also supports P.I.M. (PRINT Image Matching™) and Exif Print image enhancement standards that are built into many cameras. To see if your camera is P.I.M.-enabled, see your camera’s documentation.

Supported Photo Formats



Make sure your photos meet these requirements for printing with your PictureMate:

- ❑ JPEG files or uncompressed TIFF files only
- ❑ Resolutions ranging from 80 × 80 to 4600 × 4600 pixels

PictureMate recognizes and prints the first 999 photos on your memory card.

Where to Find Information

Unpacking and setting up



See your *Start Here* to unpack, set up, and use your PictureMate.

Printing, changing settings, and installing the printer software

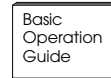

Basics Operation Guide (this book) explains how to print photos directly from your camera's memory card. It also covers how to print from other devices, replace the PictureMate Photo Cartridge, take care of PictureMate, install the printer software, and troubleshoot problems.

Using your PictureMate with a computer



The on-screen *User's Guide* on the CD provides comprehensive information and instructions for using PictureMate with a computer.

Preparing to Print

Before you can print, you need to load paper and insert your memory card in PictureMate.

Loading Paper

Follow these steps to load PictureMate Photo Paper:



Caution:

Do not load plain paper; this may damage PictureMate.

1. Move the handle to the back and down. Then open the paper support and output tray.

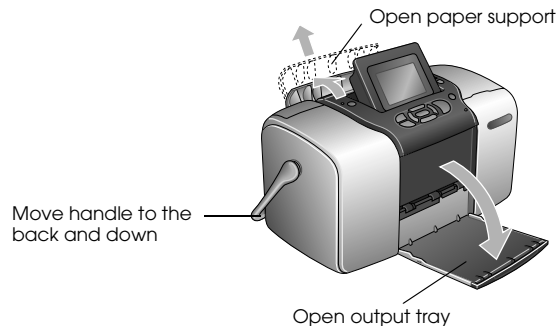

Note:

Keep the handle all the way down when printing, to allow paper to feed through.

- Slide the top part of the paper support up gently until it clicks into place.

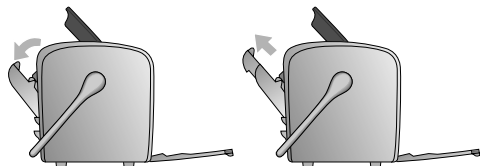

- Place your paper against the right edge, with the glossy side up.

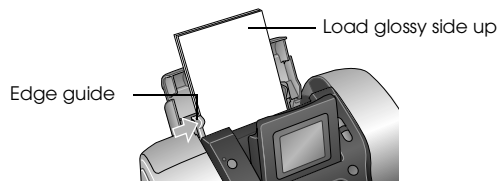

Note:

Make sure paper is glossy side up to prevent smearing.

- Slide the left edge guide against the paper. Make sure it is snug, but not so tight that paper can't move.

Note:

When you need more paper, order a PictureMate PicturePack. See "Consumable Products" on page 79 for more information.

Paper Handling Instructions

When storing printouts

- Do not touch the printed side or stack your printouts until the ink is dry.
- To avoid scratching the image, be sure not to rub the printed side of the paper. If the printed side is rubbed too strongly, ink may come off the paper.
- Do not stack printouts with the image sides touching.
- Do not stack printouts and conventional film photographs with the image sides touching.
- If you stack printouts, place a sheet of plain paper or other absorbent paper between the individual prints.

When storing unused paper

Return any unused paper to the original package, and store it away from extreme temperatures, high humidity, and bright lights.

When displaying printouts

- ❑ When displaying your printouts indoors, Epson recommends placing your printouts in glass frames to preserve the colors in your image.
- ❑ Avoid displaying your printouts outdoors or in a place exposed to direct sunlight to prevent fading.

Note:

For best results, allow your prints to dry thoroughly for 24 hours before framing.

Inserting Your Memory Card

1. Press On to turn on PictureMate.
2. Open the memory card cover.
3. Insert the memory card into the correct slot, as shown in the illustration.

Top:



SmartMedia™

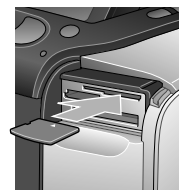

xD Picture Card™
xD-Picture Card™ Type M

Middle:



Sony Memory Stick®
Memory Stick Duo™ *
Memory Stick PRO™ *
Memory Stick PRO Duo™ *
MagicGate™ Memory Stick
MagicGate Memory Stick Duo™ *



SD (Secure Digital)
miniSD™ card **
MMC™ (MultiMediaCard™)

Bottom:



Microdrive™
CompactFlash® (Type I + II)

* Requires Memory Stick Duo adapter

** Requires miniSD adapter

Push the card in carefully until it stops (it won't go in all the way).

Insert just one card at a time.

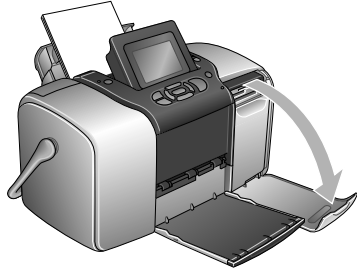

When it is in, the card light comes on.

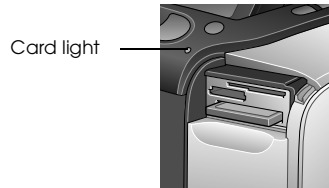

4. Close the memory card cover.

Now you can choose photos and layouts for printing from the Main Menu. See "Basic Photo Printing" on page 21.

Removing Your Memory Card

When you are ready to remove a memory card, make sure the card light is not flashing, then pull the card straight out of the slot.









Caution:

Do not remove a card while the card light is flashing; you may lose photos on your card.

Basic Photo Printing

You can choose the photos you want to print from the main menu.

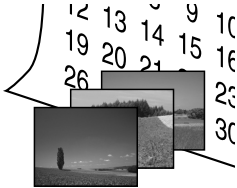
	<p>Print All: print all the photos on your card.</p>
	<p>Print Some: select several photos, and choose one or more copies for each.</p>
	<p>Print Range: print a sequence of photos on your card.</p>

	<p>Print Index: print a thumbnail view of all the photos stored in your memory card.</p>
	<p>Print by Date: search photos by the date they were taken, and select the photos you want.</p>
	<p>Add Frame: print a photo with a frame from your printer or memory card.</p>
	<p>Camera-selected DPOF photos: print a set of photos that you pre-selected in your digital camera using DPOF.</p>

Make sure your memory card is inserted in PictureMate and the Main Menu is on the screen, then follow the steps below for the option you want.

Printing All Photos



1. Press ◀ or ▶ to highlight Print All, then press OK.
2. Press ▲ or ▼ to select the number of copies.

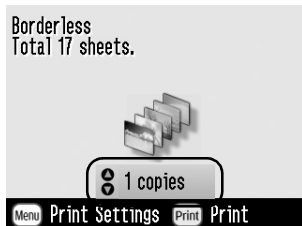

3. Press OK to confirm your print selections.
4. Press Print to start printing.

Printing Several Photos



1. Press ◀ or ▶ to choose Print Some, then press OK.
2. Press ◀ or ▶ to view the photo you want to print.

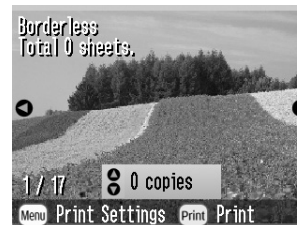

Note:

You can switch the view of photos by pressing Ⓜ or Ⓛ

- Press \odot or \ominus to choose the number of copies to print for that photo (up to 100).

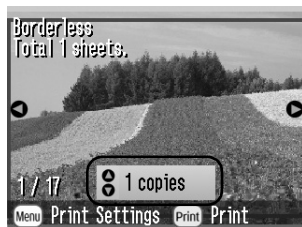

- Repeat steps 2 and 3 for additional photos.
- Press OK to confirm your print selections.
- Press Print to start printing.

Printing Range of Photos



Follow the steps below to print a range (or sequence) of consecutive photos from your camera's memory card. Selecting a range is convenient because you don't have to choose each individual photo.

- Press \odot or \triangleright to highlight Print Range, then press OK. Thumbnail images of the photos appear.
- Press \odot or \triangleright to choose the first photo. Then press OK.



3. Press \leftarrow or \rightarrow to choose the last photo.



4. Make sure that the photos you want to print are highlighted in blue, then press OK.
5. Press \triangle or ∇ to select the number of copies.
6. Press OK to confirm your print selections.
7. Press Print to start printing.

Printing Photos Searching by Date



If you know the date the photos were taken, you can find and print them easily using this menu.

1. Press \leftarrow or \rightarrow to highlight Print by Date, then press OK.
2. Press \triangle or ∇ to highlight the date you want, then \rightarrow to check the date. To clear the check, press \leftarrow .

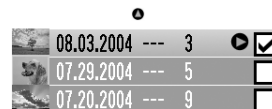

3. Press OK.

- Press ◀ or ▶ to select the photo you want.

Note:

You can switch the view of photos by pressing Ⓜ or Ⓛ

- Press ▲ or ▼ to select the number of copies for that photo.

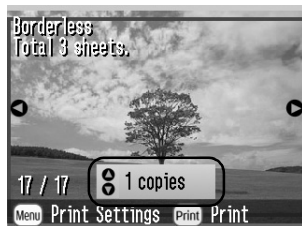

- Repeat steps 4 and 5 for additional photos.
- Press OK to confirm your print selections.
- Press Print to start printing.

Printing an Index



- Press ◀ or ▶ to highlight Print Index, then press OK.
- Press OK to confirm your print selections.
- Press Print to start printing.

Printing a Photo With a Frame



You can make your photo more fun by printing it with a frame! As well as the preset frames, you can add frames from the memory card by using PIF DESIGNER and EPSON PRINT Image Framer Tool software. For details on installing the software, see “Installing the Printer Software” on page 62. For details on using the software see the online *User’s Guide*.

Note:

If you want to print a photo with a frame you previously specified by EPSON camera, see “Printing a Photo With a Frame Specified by Camera” on page 36.

1. Press ◀ or ▶ to select the Add Frame and press OK.
2. Press ◀ or ▶ to select the photo and press OK.



3. Press ◀ or ▶ to select the frame and press OK.



A preview of the photo and the frame you selected appears.

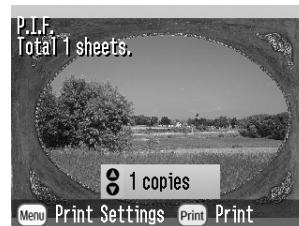

Note:

If you select a frame from the memory card, you cannot see the preview of the photo and frame.

4. Press ⊕ or ⊖ to select the number of copies.
5. Press OK to confirm your print selections.

6. Press Print to start printing.

Printing Camera-Selected DPOF Photos

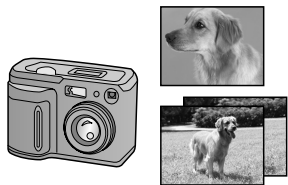

If your camera supports DPOF (Digital Print Order Format), you can use it to pre-select which photos and how many copies you want to print. See your camera's manual to choose photos for printing with DPOF, then insert your memory card in PictureMate. PictureMate automatically reads your pre-selected photos.

1. Load paper and a memory card that contains DPOF data.

2. When this message appears, press OK.

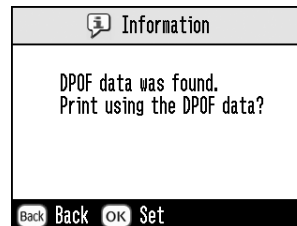

3. Press Print to start printing.

Doing More With Your Photos

By pressing Menu during the print settings, you can modify your prints, as follows:

- ❑ Print photos in various layouts
- ❑ Print photos with the time and/or date
- ❑ Print photos in black and white or a sepia tone
- ❑ Print out part of the photo
- ❑ Adjust or enhance photo prints
- ❑ Print a photo with a frame specified by camera

You can also view all the photos stored on your memory card in sequence like a slide show from the Main Menu.





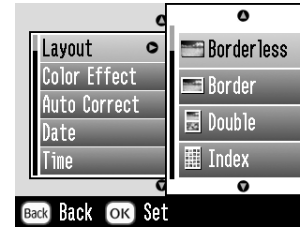

Choosing a Layout

1. After selecting photos and the number of copies, press Menu.

2. Press \triangle or ∇ to highlight Layout, then press \triangleright to open the menu.
3. Press \triangle or ∇ to highlight the layout setting you want for your photo(s), then press OK.



You have the following choices:

- | | | | |
|---|---------------------------------------|---|---|
|  | Borderless |  | Index |
|  | Border |  | Half Page
(2 per sheet without a border) |
|  | Double
(2 per sheet with a border) |  | Photo ID |

Note:

To print two double-sized photos on one sheet, select multiple copies or multiple photos.

4. If you do not need to change any other settings, press OK to close the menu.
5. Press OK to confirm your print selections.
6. Press Print to start printing.

Adjusting the amount of image enlarged during borderless printing

When Borderless is selected the image is enlarged automatically to eliminate the borders. This may cut off part of your image. The following steps explain how to control the amount of the image that is enlarged.

1. On the Main Menu or after selecting photos, press Menu.
2. Press \triangle or ∇ to select Setup, then press \rightarrow to open the menu.
3. Press \triangle or ∇ to select Borderless Expansion, then press \rightarrow .

4. Press \triangle or ∇ to select the setting, then press OK.

Note:

For most print jobs, selecting Max is recommended in order to eliminate margins on all sides of the paper. Selecting Min decreases the amount of the image that extends beyond the edges of the paper; however, as this amount decreases, margins may begin to appear on one or more sides of the paper.

Adding the Date or Time

You can add the date and/or time your photo was originally taken to the bottom right corner of your print.

1. After selecting the photo(s) and number of copies, press Menu.

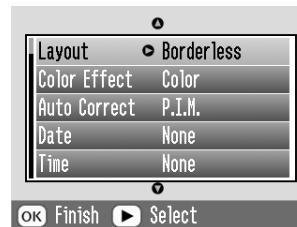

- To print the date, press \triangle or ∇ to highlight Date, then press \blacktriangleright to open the menu.

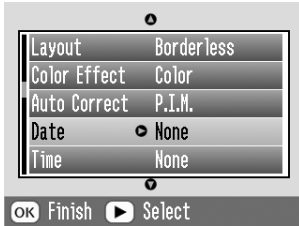

- Press \triangle or ∇ to choose a setting:

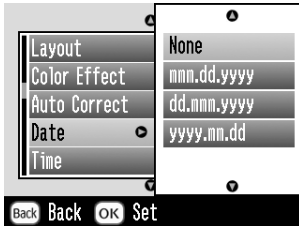

- None (default, turns off the date stamp)
- mmm.dd.yyyy (Sep.01.2004)
- dd.mmm.yyyy (01.Sep.2004)
- yyyy.mm.dd (2004.09.01)

- Press OK.
- To print the time, press \triangle or ∇ to highlight Time, then press \blacktriangleright to open the menu.

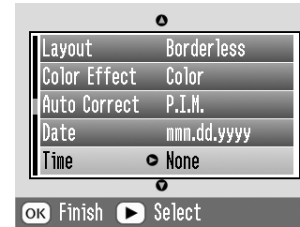

- Press \triangle or ∇ to choose a setting:

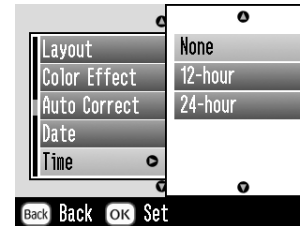

- None (default, turns off the time stamp)
- 12-hour (03:00 for 3 pm)
- 24-hour (15:00 for 3 pm)

7. Press OK.
8. If you do not need to change any other settings, press OK to close the menu.
9. Press OK to confirm your print selections.
10. Press Print to start printing.

Printing Photos in Black and White or Sepia

You can print your photo in black and white or in a sepia tone without changing the original photo.

Note:

A sepia print has a brownish tone, for an old-fashioned photo look.

1. After selecting photo(s) and number of copies, press Menu.

2. Press \triangle or ∇ to highlight Color Effect, then press \triangleright to open the menu.

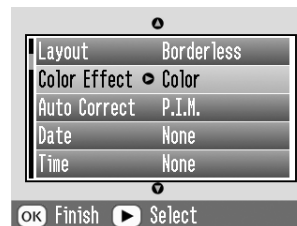

3. Press \triangle or ∇ to choose B&W or Sepia, then press OK.
4. If you do not need to change any other settings, press OK to close the menu.
5. Press OK to confirm your print selections.
6. Press Print to start printing.

Cropping Your Photo

You can print just part of a photo, cropping out the area that you don't want. You can choose only one photo to crop at a time.

1. Choose the photo you want to crop with the Print Some or Print by Date option. See "Printing Several Photos" on page 22 or "Printing Photos Searching by Date" on page 24.
2. Press $\text{\textcircled{C}}$ to crop a photo. You will see a frame around the cropped area.



3. Use the following procedures to set the area you want to crop.
 - Press $\text{\textcircled{C}}$ or $\text{\textcircled{D}}$ to change the frame size.
 - Press $\text{\textcircled{\u2191}}$, $\text{\textcircled{\u2193}}$, $\text{\textcircled{\u2190}}$ or $\text{\textcircled{\u2192}}$ to move the frame.

- Press Menu to rotate the frame.

4. Press OK to confirm the cropped image.

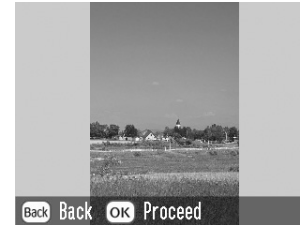

Note:

This setting remains in effect until you print or press Cancel.

5. After checking the cropped image, press OK.
6. If you do not need to change any other settings, press OK to confirm your print selections.
7. Press Print to start printing.

Fixing Your Photos

PictureMate lets you correct the color and improve the image quality of your photos without using a computer. Three basic types of adjustments are available:

- ❑ Automatic adjustments

If your camera supports PRINT Image Matching or Exif Print, you can use the printer's P.I.M. or Exif Print setting to automatically adjust your photos for the best results.

If your camera doesn't support PRINT Image Matching or Exif Print, you can use PhotoEnhance to make adjustments for the type of environment in which your photos were taken.

- ❑ Manual adjustments

If your photos are too light or too dark, you can adjust their brightness or control the saturation and sharpness.

If you want, you can make manual adjustments while P.I.M., Exif Print, or PhotoEnhance are turned on in order to fine-tune your automatic settings.

- ❑ Enhance small photos

If your photos are small you can increase the resolution so that they can be printed at larger sizes. You can also remove digital noise or interference from photos.

Note:

These settings affect only your printed pictures. They do not change your original image files.

Automatically Fixing Your Photos

1. After selecting the photo(s) and number of copies, press Menu.
2. Press \triangle or ∇ to highlight Auto Correct, then press \triangleright to open the menu.

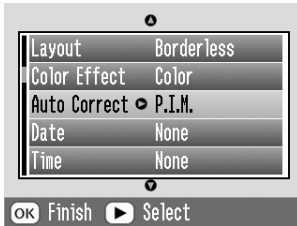

3. Press \triangle or ∇ to choose one of the options.
 - P.I.M.** - PictureMate chooses this setting automatically if it detects P.I.M. information that your camera saved in your digital files. This information helps ensure an accurate image reproduction.

- Exif Print** - PictureMate chooses this setting automatically if it detects Exif Print information saved in your camera's digital files. This information helps ensure that your photos are printed accurately.
- PhotoEnhance** - Use this if a print does not look good; for example, this may correct images that are too dark, too bright, or backlit.
- None** - Prints photos as is or bypasses P.I.M. or Exif Print data (default setting for files with no P.I.M. or Exif Print data).

4. Press OK.
5. If you do not need to change any other settings, press OK to close the menu.
6. Press OK to confirm your print selections.
7. Press Print to start printing.

Manually Fixing Your Photos

1. After selecting the photo(s) and number of copies, press Menu.
2. Press \triangle or ∇ to highlight Fix Photo, then press \blacktriangleright to open the menu.

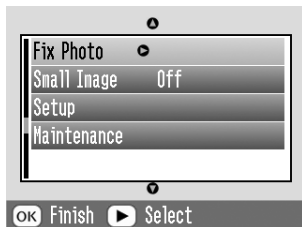

3. Select Brightness, Saturation, or Sharpness, then press \blacktriangleright .
4. Adjust the settings as necessary, then press OK twice.
5. If you do not need to change any other settings, press OK to close the menu.
6. Press OK to confirm your print selections.
7. Press Print to start printing.

Enhancing Small Photos

1. After selecting the photos and the number of copies, press Menu.
2. Press \triangle or ∇ to select Small Image, then press \blacktriangleright to open the menu.



3. Press \triangle or ∇ to select On, then press OK.
4. If you do not need to change any other settings, press OK to close the menu.
5. Press OK to confirm your print selections.
6. Press Print to start printing.

Printing a Photo With a Frame Specified by Camera

If you want to print a photo with a frame you previously specified by EPSON camera, follow the steps below.

1. On the Main Menu, or after selecting photos, press Menu.
2. Press \triangle or ∇ to select Setup, then press \rightarrow to open the menu.
3. Press \triangle or ∇ to select Enable P.I.F. Relation, then press \rightarrow .
4. Press \triangle or ∇ to select On, then press OK.
5. Press OK to confirm the setting, and press OK again to close the menu.
6. Select the photos from the Print All, Print Some, Print Range, or Print by Date menu and print.

Note:

This setting is available only when Borderless or Border is selected in the layout setting of Change Personal Defaults.

Viewing a Slide Show

1. On the Main Menu, press \leftarrow or \rightarrow to select Play Slide Show and press OK.
2. PictureMate shows the photos in the memory card in sequence.
 - Press OK to pause the slide show. Press OK again to resume the slide show.
 - Press any button except OK to end the slide show.

Saving Your Photos to an External Device

You can save photo files on your memory card to a computer when you connect it to PictureMate with a USB cable. You can also save photos to an external device that you connect directly to PictureMate.

1. Make sure PictureMate is on.
2. Insert your memory card into PictureMate.



Saving Photos to an External Device

Connect an external storage device directly to PictureMate and save your photo files to one of these:

- CD-R/RW drive (CD-R media only)
- Iomega[®] Zip[®] disk (100, 250, or 750MB)
- Flash memory (thumb) drive

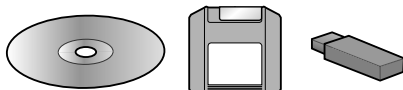

Note:

Epson cannot guarantee the compatibility of any drives.

3. If you are using a CD-R/RW drive or Zip drive, plug it into an electrical outlet if required.
4. Connect the drive to PictureMate:

- ❑ For a CD-R/RW or Zip drive, connect its USB cable to the EXT/IF port on the back of PictureMate. Then insert a CD-R or Zip disk in the drive.

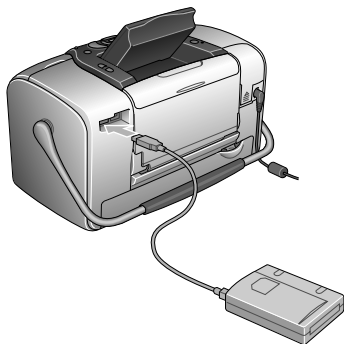

- ❑ For a flash memory drive, plug it into the EXT/IF port on the back of PictureMate.

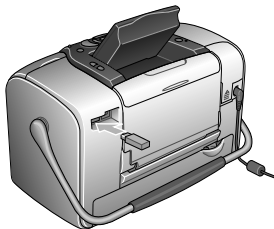

Note:

- ❑ *If you see the message “Insufficient space on the external device. Backup cannot be performed” press CANCEL and insert a new CD-R or Zip disk, or connect a flash memory drive with more free space.*
- ❑ *If you insert a blank CD-R in the drive before inserting a memory card in PictureMate, you may see an error message. Eject the CD-R from the drive to clear the error, insert your memory card, then re-insert the CD-R.*

5. On the Main Menu, press Menu.
6. Press Δ or ∇ to select Setup, then press \triangleright to open the menu.
7. Press Δ or ∇ to select Save to External Drive, then press \triangleright .

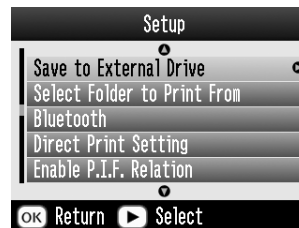

8. Confirm the following message, then press OK.

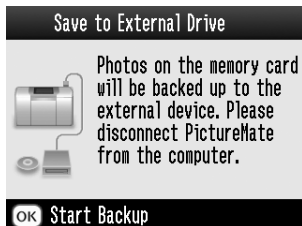

9. Press OK to start saving your photos.

**Caution**

Do not remove the drive or memory card while the photos are being saved, or you may lose photos on your card or drive. If you need to stop the backup, press Cancel.

You can save photos multiple times to the same disk or drive until it is full. Each time you save photos on the same disk or drive, they are saved in a new folder. The first folder is named 001, the second folder is named 002, etc. If you save on a CD-R, PictureMate names the CD-R Photo.

Printing From an External Device

PictureMate can print stored photos on a computer or on another device such as an external hard drive, a Bluetooth-enabled device, or a digital camera.

3. If a memory card is inserted, the printer will read photos from the card, not from an external drive.
4. If PictureMate is connected to a computer, disconnect it or turn off the computer.

Printing From an External Drive

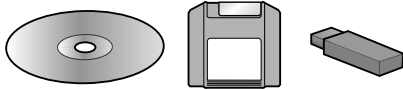

If you saved your photos to a CD, Zip disk, or flash memory (thumb) drive, you can connect the drive to the back of PictureMate and print just like you do when you insert a memory card.

You can also print photos from a CD that you get from a photo processing lab. (Images should be in JPEG file format. Some CDs may not work.)

1. Make sure PictureMate is on.
2. Make sure there are no memory cards in PictureMate's memory card slots. The card light should be off.

Connect your CD or Zip drive's USB cable, or plug your flash memory drive into the EXT/IF port on the back of PictureMate.

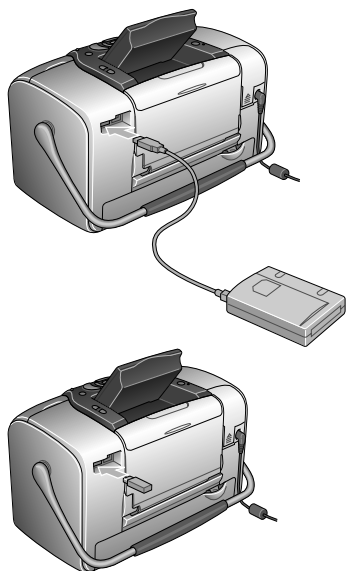

- For a CD or Zip drive, insert a CD or Zip disk with photos into the drive.

If you used PictureMate to save photos on the same CD-R, Zip disk, or flash memory drive more than once, it will have multiple folders. You see this message:

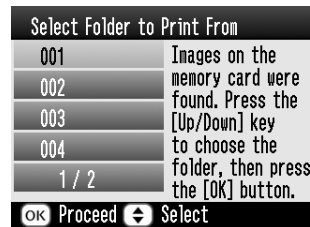

Press \triangle or ∇ to choose the folder where your photos are stored, then press OK. The most recently saved folder has the largest number.

6. PictureMate counts the photos on your drive, then shows the following screen:

If you see this screen, print your photos from the Main Menu (see “Basic Photo Printing” on page 21).

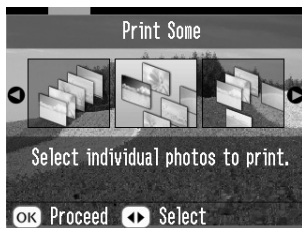

Printing From a PictBridge-Enabled Camera

You can connect your PictBridge- or USB DP-enabled digital camera to the back of PictureMate and use the camera to control printing. (See your camera manual to see if it supports the PictBridge standard or USB DP.)

1. Make sure PictureMate is on.

2. Make sure there are no memory cards in PictureMate’s slots. The card light should be off.

Note:

If a memory card is inserted, the printer will read photos from the card, not from a camera.

3. Press Menu.
4. Press \triangle or ∇ to select Setup, then press \triangleright .
5. Press \triangle or ∇ to select Direct Print Setting, then press \triangleright .
6. Press \triangleright again to open the layout menu.
7. Press \triangle or ∇ to select the desired option, then press OK.
8. Press OK twice to return to the Menu option. Change the Color Effect, Auto Correct, Date, Time, Fix Photo, and Small Image settings if necessary.

9. Connect your camera's USB cable to your camera and the EXT/IF port on the back of PictureMate.

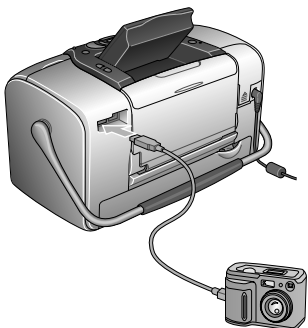

10. Use the digital camera to select the photo you want to print. Be sure to make the desired print settings on the digital camera because the digital camera settings generally take precedence over the print settings of PictureMate. See your digital camera's documentation for information on more detailed settings.
11. Print from the digital camera.

Printing From a Bluetooth Device

About the Bluetooth Photo Print Adapter

The optional Bluetooth Photo Print Adapter is a wireless communication module used to print from digital cameras and other devices with Bluetooth wireless technology without cables when connected to the printer.

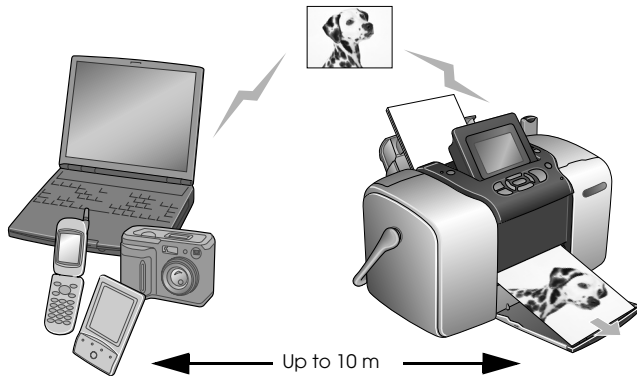

Note:

- ❑ While this product complies with the Bluetooth Specification, it is not guaranteed to work with all devices enabled with Bluetooth wireless technology.
- ❑ The communication range of this product is approximately 10 meters; however, this may vary depending on conditions including obstacles between devices; signal quality; magnetic fields; static electricity and electromagnetic interference; software; operating system; reception sensitivity; and antenna performance.

Available Profile

Basic Printing Profile (BPP)

Basic Imaging Profile (BIP)

Hardcopy Cable Replacement Profile (HCRP)

Object Push Profile (OPP)

Connecting and Disconnecting the Bluetooth Photo Print Adapter

Connecting

1. Insert the Adapter connector into the EXT/IF port as shown below.

**Caution:**

Do not connect this product while the printer is operating. Doing so may cause the printer to malfunction.

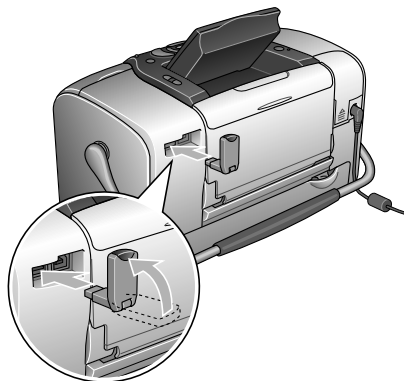

2. The Adapter's light comes on for one second. If the LED does not turn on, disconnect the Adapter from the printer, then reconnect it.

Disconnecting

Remove the Adapter's connector from the EXT/IF port as shown below.

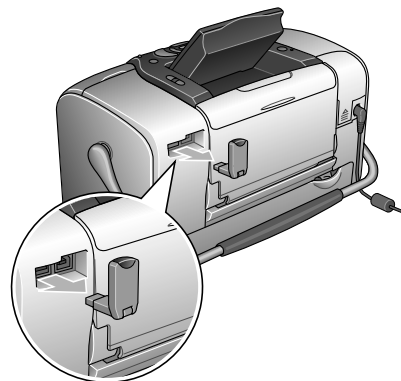

**Caution:**

- ❑ *Do not remove this product while communicating with another device.*

- ❑ *Do not disconnect this product while the printer is operating. Doing so may cause the printer to malfunction.*

- ❑ *Do not remove this product by pulling on its upper section. Doing so may damage the product.*

Bluetooth Settings

Use the LCD panel on the printer to make settings for Bluetooth wireless communication.

➔ See “Making settings” on page 47

Outline of settings

Setting	Choices	Description
BT Printer ID Set	printer name-(number) (Default = 1)	If multiple printers enabled with Bluetooth are in the same communication range, distinguish them by assigning each number from 0 through 9. To make the Device Name setting take effect, turn the printer off and then back on.

Connectivity Mode	Public	This mode allows devices enabled with Bluetooth to freely discover the printer and print.
	Private	This mode prevents unknown devices from discovering the printer. To print in Private mode, first search for the printer once in Public mode. After your device has discovered the printer in Public mode once, it will subsequently be able to communicate with and print from it in Private mode.
	Pairing	This mode requires that the four-digit Passkey be entered into a device before it can communicate with and print from the printer.
BT Encryption	On/Off (Default = Off)	Select On to encrypt communication. Encryption requires that the four-digit Passkey be entered into a device before it can communicate with and print from the printer.
PIN Code Set	Any four-digit number (Default = 0000)	The Passkey setting allows you to set the four-digit Passkey that must be entered into a device before printing if Bonding is selected as the Communication Mode or if Encryption is On.

BT Device Address	Set at the factory (Example) 11-11-11-11-1 1-11	Displays the unique Bluetooth Device Address of the printer.
-------------------	--	--

Making settings

1. Connect the Bluetooth Photo Print Adapter to your printer.
➔ See “Connecting and Disconnecting the Bluetooth Photo Print Adapter” on page 45



Caution:

Be sure that the printer is not operating before connecting this product. Otherwise, the printer may malfunction.

2. Press Menu.
3. Press \triangle or ∇ to select Setup, then press \triangleright to open the menu.
4. Press \triangle or ∇ to select Bluetooth, then press \triangleright .

5. Change the settings of each item. See “Outline of settings” on page 46 for information about Bluetooth settings.

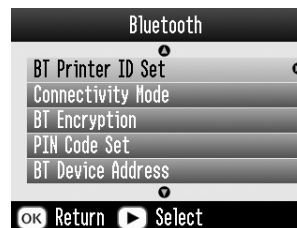

The Bluetooth Passkey Setting (PIN Code Set)

If you select Pairing as the Connectivity Mode or On as the BT Encryption setting, the Passkey must be entered into a Bluetooth wireless-capable device before it can communicate with and print from the printer. The default Passkey is 0000.

To change the Passkey, follow the instructions below. A Passkey of 1234 is used as an example.

1. Press \triangle or ∇ to select PIN Code Set, then press \triangleright .

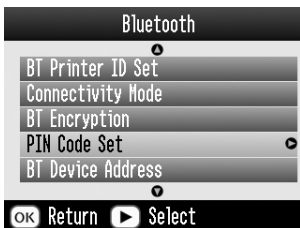

2. Press \triangle or ∇ to select a number for the first digit, then press \triangleleft or \triangleright to change the digit.



3. Select numbers for the second through fourth digits in the same manner, then press OK to activate the Passkey.

Printing

1. Make sure the Bluetooth Photo Print Adapter is connected to PictureMate and Bluetooth settings have been made. For details on connecting the Bluetooth Photo Print Adapter, see "Connecting and Disconnecting the Bluetooth Photo Print Adapter" on page 45. See "Bluetooth Settings" on page 46 to set the Bluetooth settings.
2. Press Menu.
3. Press \triangle or ∇ to select Setup, then press \triangleright .
4. Press \triangle or ∇ to select Direct Print Setting, then press \triangleright .

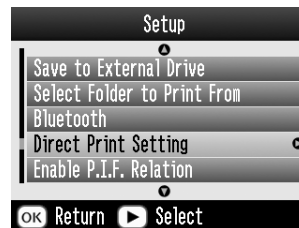

5. Press \triangleright again to open the layout menu.

6. Press \odot or \ominus to select the desired option, then press OK.
7. Press OK twice to return to the Menu option. Change the Color Effect, Auto Correct, Date, Time, Fix Photo, and Small Image settings if necessary.
8. Print the data from your Bluetooth enabled device.

Note:

The settings available may vary among Bluetooth wireless-capable devices. For more information, refer to your device's documentation.

For more information about printing from Bluetooth wireless-capable digital still cameras, digital video cameras, PDAs, mobile PCs and other Bluetooth wireless-capable device, refer to the documentation for both the device and the printer.

Replacing the Photo Cartridge

Checking the Photo Cartridge Status (Ink Level)

You can check the approximate ink level in your photo cartridge at any time.

1. On the Main Menu or during print settings, press Menu.
2. Press \triangle or ∇ to highlight Maintenance, then press \blacktriangleright .



3. Press \triangle or ∇ to highlight Ink Level, then press \blacktriangleright .

4. You see a screen showing the approximate ink level in your photo cartridge. Press OK to close the screen.

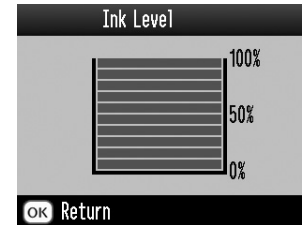

Replacing the Photo Cartridge

This printer uses photo cartridge equipped with an IC chip. The IC chip accurately monitors the amount of ink, so even if it is removed and later reinserted, all of its ink can be used. However, some ink is consumed each time the cartridge is inserted because the printer automatically checks reliability.

**Warning:**

Keep photo cartridges out of the reach of children. Do not allow children to drink from or otherwise handle the cartridges.

**Caution:**

- ❑ *Epson recommends the use of genuine Epson photo cartridges. Epson warranties do not cover damage to your printer caused by the use of ink cartridges not manufactured by Epson.*
- ❑ *Leave the old cartridge installed in the printer until you have obtained a replacement; otherwise, ink remaining in the print head nozzles may dry out.*
- ❑ *Do not refill photo cartridges. The printer calculates the amount of ink remaining using an IC chip on the photo cartridge. Even if the cartridge is refilled, the amount of ink remaining will not be recalculated by the IC chip and the amount of ink available for use will not change.*

Note:

In addition to the ink used during an image printing, ink is consumed during the print head cleaning operation, during the self-cleaning cycle which is performed when the printer is turned on, and during ink charging when the photo cartridge is installed in the printer.

For more information about photo cartridges.

➔ See “When handling photo cartridges” on page 12

1. Make sure that PictureMate is on, but not printing.

Note:

Check the ink status.

➔ See “Checking the Photo Cartridge Status (Ink Level)” on page 50

2. Check that the message “Ink out.” is displayed on the LCD panel. This message is not displayed if there is some ink left.
3. Close the paper support and paper feeder.

4. Move the handle to the cartridge replacement position.

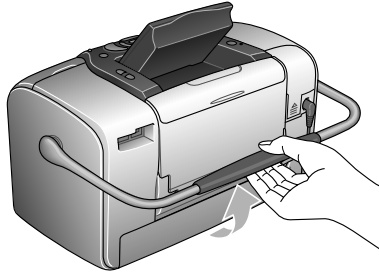

5. Open the cartridge compartment cover on the back of the printer.

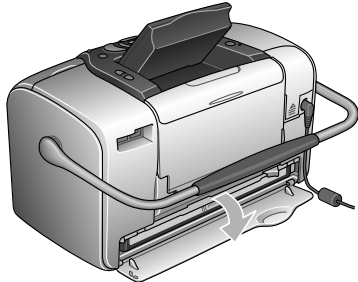

6. Set the cartridge lock lever in the Release position by sliding the lever to the right, then down and to the left. The photo cartridge will be ejected about halfway out of the holder. Pull the cartridge out of the printer and dispose of it properly.

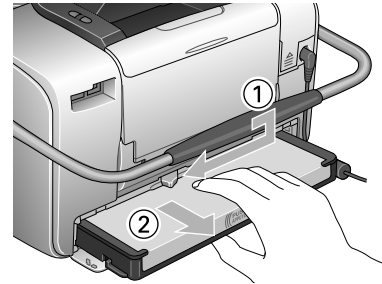

Note:

- ❑ Do not take the used cartridge apart or try to refill it. Do not shake the used photo cartridge; otherwise, it may leak.
- ❑ The photo cartridge must be replaced when any one of the colors is depleted. The rate that a specific color of ink is consumed depends on the images printed.

7. For best results, shake the new photo cartridge four or five times before opening the package.

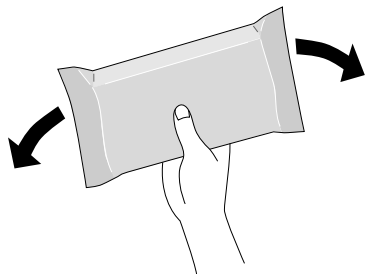

8. Remove the replacement photo cartridge from its package.



Caution:

- ❑ Do not touch the green IC chip on the bottom of the cartridge. This can damage the photo cartridge.

Do not touch this part.

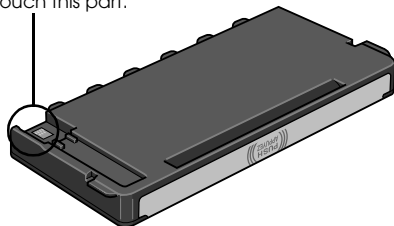

- ❑ If you remove the photo cartridge for later use, be sure to protect the ink supply ports from dirt and dust; store it in the same environment as the printer. Note that there is a valve in the ink supply ports, making covers or plugs unnecessary, but care is needed to prevent the ink from staining items that the cartridge touches. Do not touch the ink supply ports or surrounding area.
- ❑ Be sure to always install a photo cartridge into the printer immediately following the removal of the current photo cartridge. If a photo cartridge is not installed promptly, the print head may dry out, rendering it unable to print.

- Place the cartridge properly into the cartridge holder, then push it in until you feel resistance and hear the cartridge faintly click into place.

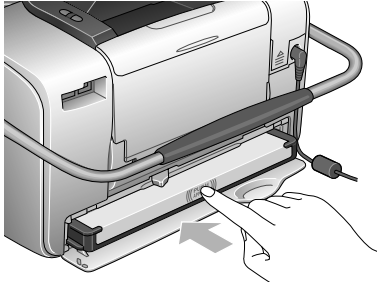

Note:
After installing the cartridge, make sure the sides of the cartridge are even. If either side of the cartridge sticks out, push the side of the cartridge until it clicks.



10. Set the lever to the Lock position by sliding it in the direction shown.

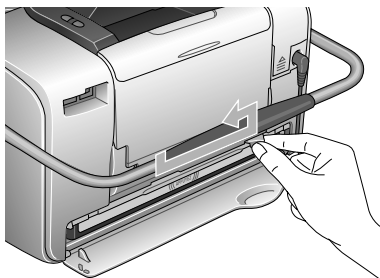

11. Close the cartridge compartment cover.

Note:

If you cannot close the cartridge compartment cover, the photo cartridge is not installed correctly. Go back to the Step 5 and eject the photo cartridge. Then install the photo cartridge again.

Taking PictureMate With You

PictureMate's handle makes it easy to carry short distances. If your PictureMate is going to travel a longer distance, you should pack it carefully to protect it from getting damaged.



Caution:

Keep PictureMate out of the sun and don't leave it in your car or other location where it can get too hot.



1. If PictureMate is on, turn it off.
2. Wait until the LCD screen goes blank, then unplug the power cord from the electrical outlet.
3. Remove paper from the paper support and output tray.
4. Push down the top of the paper support and close it against PictureMate. Then close the output tray.

5. Close the LCD panel.

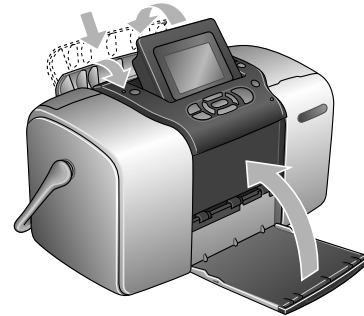

6. Disconnect the power cord and any connected USB cable from the back of PictureMate.



7. Pack PictureMate along with its power cord and AC adapter in the box that PictureMate came.

**Caution:**

Make sure the photo cartridge is installed before transporting. Don't place PictureMate on its side or upside down, or ink may leak.

Note:

If your prints don't look as good after PictureMate has been moved, try aligning the print head. See "Aligning the Print Head" on page 67.

Setting PictureMate Preferences

You can change these settings (preferences) on PictureMate:

- ❑ Changing the View of Photos on the LCD Screen
➔ See “Changing the View of Photos on the LCD Screen” on page 58
- ❑ Setting the After Printing Confirmation
➔ See “Setting the After Print Confirmation” on page 59
- ❑ Adjusting the LCD Screen Contrast
➔ See “Adjusting the LCD Screen Contrast” on page 60
- ❑ Selecting the language on the LCD screen
➔ See “Selecting the Language on the LCD Screen” on page 60
- ❑ Changing the printer’s default settings to your preferences
➔ See “Changing the Default Settings” on page 61

And you can reset them to their factory default settings if necessary.

➔ See “Resetting All Print Settings” on page 61.

Changing the View of Photos on the LCD Screen

You can change the view of photos on the Print Some or Print by Date menu from the following options.

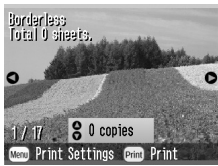
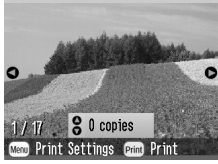
1up (with info)		Displays one photo with layout information and the total number of copies at a time.
1up (no info)		Displays one photo without information at a time.



Follow the steps below to change the setting.

1. On the Main Menu, press Menu.
2. Press \triangle or ∇ to select Setup, then press \rightarrow to open the menu.
3. Press \triangle or ∇ to select Display Setting, then press \rightarrow .
4. Select the desired option, then press OK.

Setting the After Print Confirmation

This setting lets you decide whether to keep the print settings you selected or return the settings to the default you selected in Change Personal Defaults setting. For more information on making your own default settings, see “Changing the Default Settings” on page 61.

1. On the Main Menu, or after selecting photos, press Menu.
2. Press \triangle or ∇ to select Setup, and press \rightarrow to open the menu.
3. Press \triangle or ∇ to select Keep Settings After Printing, then press \rightarrow .
4. Press \triangle or ∇ to choose the desired settings, then press OK.
 - Ask Each Time:** Display the confirmation screen after printing and let you choose whether to keep your settings or return to the default you selected.
 - Always:** Keep the settings after printing.
 - Never:** Return to the personal default settings.

Note:

Even when you select Always or Ask Each Time and choose to keep the settings, they will not be kept in the following cases.

- When you select another print option.*

- ❑ *When the memory card is removed.*
- ❑ *When PictureMate is turned off.*

4. Press \triangle or ∇ to adjust the contrast, then press OK.

Adjusting the LCD Screen Contrast

If the LCD screen is difficult to read, you can adjust the contrast.

1. On the Main Menu, or after selecting photos, press Menu.
2. Press \triangle or ∇ to select Setup, then press \triangleright to open the menu.
3. Press \triangle or ∇ to select LCD Contrast Adjustment, then press \triangleright .



Selecting the Language on the LCD Screen

You can change the language displayed on the LCD panel. Follow the steps below to change the settings.

1. On the Main Menu, or after selecting photos, press Menu.
2. Press \triangle or ∇ to select Setup, then press \triangleright to open the menu.
3. Press \triangle or ∇ to select Language, then press \triangleright to open the menu.
4. Press \triangle or ∇ to select your preferred language, then press OK.

Changing the Default Settings

You can change the printer's default settings to your own personal preferences.

You can change the following default settings.

- Color Effect
- Date
- Time
- Top screen
- Layout

Follow the steps below to change the settings.

1. On the Main Menu, press Menu.
2. Press \triangle or ∇ to select Setup, then press \blacktriangleright to open the menu.
3. Press \triangle or ∇ to select Change Personal Defaults, then press \blacktriangleright .
4. Follow the on screen information to change the settings.

Resetting All Print Settings

You can reset the PictureMate preferences to the original, default settings.

1. On the Main Menu, press Menu.
2. Press \triangle or ∇ to select Setup, then press \blacktriangleright to open the menu.
3. Press \triangle or ∇ to select Restore Factory Defaults, then press \blacktriangleright .
4. After confirming the message on the LCD panel, press OK to restore the settings. All the settings are restored to their defaults.
5. After resetting, a confirmation message is displayed asking if you want to set the Personal Default Settings. Follow the on screen instructions to change the setting.

Using PictureMate With a Computer

When you connect PictureMate to a computer with a USB cable, you can print photos that are stored on your computer, or save photo files from your memory card to a computer. See the following procedure to install the printer software, and see the online *User's Guide* for details on using PictureMate with a computer.

Installing the Printer Software

1. Press On to turn off PictureMate.
2. Connect PictureMate and computer with a USB cable.

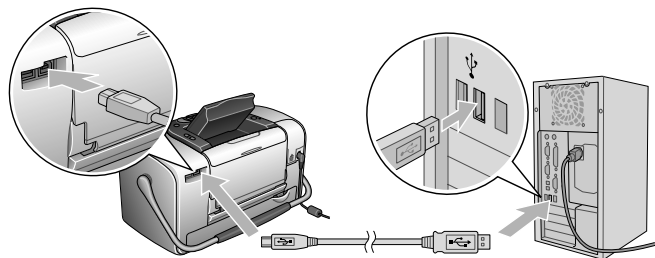

3. Insert the printer software CD into the CD-ROM drive.
4. Install the software.

For Windows

The following screen appears. Click Easy Install and follow the on-screen instructions.



Note:

If the installer dialog box does not appear, double-click the CD-ROM icon.

For Mac OS X

Double-click the Mac OS X icon, then click Easy Install. Follow the on-screen instructions.

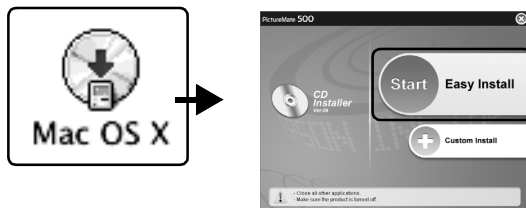

For Mac OS 9

1. Double-click the Mac OS 9 icon.



2. Click the  button beside the User's Guide, then follow the on-screen instructions to install the User's Guide.

- Click the  button beside the Printer Driver, then follow the on-screen instructions to install the printer driver.

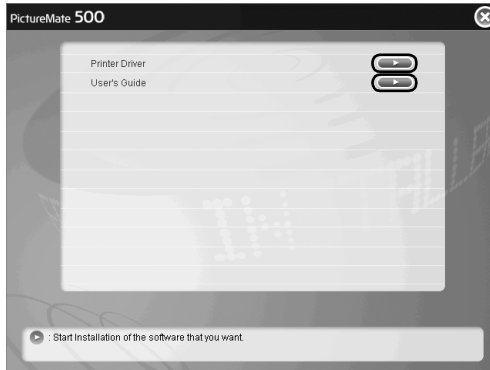

- Turn on PictureMate.
- From the Apple menu, select Chooser.



- Select the PictureMate 500 icon, then select the printer port.

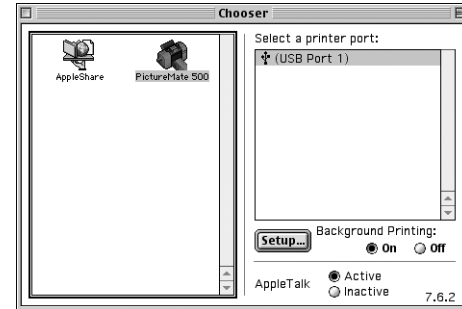

Maintaining PictureMate

Checking the Print Head Nozzles

If you find that the printout is unexpectedly faint or that dots are missing, you may be able to identify the problem by checking the print head nozzles.

Note:

You cannot clean the print head if the message “ink out” is displayed or the ink icon is displayed to show ink out or ink low on the LCD panel. Replace the photo cartridge first.

Follow the steps below to check the print head nozzles using the control panel buttons.

1. Make sure that the printer is turned on and no warnings or errors are displayed on the LCD panel.
2. Load a sheet of paper. See “Loading Paper” on page 17.
3. On the Main Menu, or after selecting photos, press Menu.
4. Press \triangle or ∇ to select Maintenance, then press \triangleright .
5. Press \triangle or ∇ to select Nozzle Check, then press \triangleright .
6. Follow the instructions displayed in the LCD panel and press Print.
7. The nozzle check pattern is printed out. See the following illustration. If it is necessary to clean the print head, press OK.

The printer will print a nozzle check pattern. Below are sample printouts.

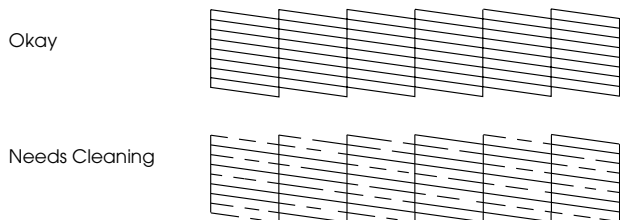

The above sample may be shown in black and white, but the actual test prints in color (Cyan, Magenta, Yellow, Black, Red and Blue).

If the nozzle check page does not print satisfactorily (for example, if any segment of the printed lines is missing), there is a problem with the printer. This could be a clogged ink nozzle or a misaligned print head.

See the next section for details on cleaning the print head.

Cleaning the Print Head

If your print quality is not as good as it used to be, if your photos are light or faint, or you are missing colors in your prints, your print head nozzles may be clogged.

Note:

- ❑ *Print head cleaning consumes some ink. To avoid wasting ink, clean the print head only if print quality declines; for example, if the printout is blurry or the color is incorrect or missing.*
 - ❑ *Use the Nozzle Check function first to confirm that the print head needs to be cleaned. This saves ink.*
 - ❑ *You cannot clean the print head if the message “ink out” is displayed or the ink icon flashes to show ink low on the LCD panel.*
1. Make sure that PictureMate is turned on and no warnings or errors are displayed on the LCD panel.
 2. On the Main Menu, or after selecting photos, press Menu.

3. Press \triangle or ∇ to select Maintenance, then press \blacktriangleright .
4. Press \triangle or ∇ to select Clean Print Head, then press \blacktriangleright .
5. Confirm the messages on the LCD panel, then press OK to start head cleaning.

Cleaning takes several seconds, during which the message Print head cleaning is in progress. Please wait. appears on the screen.

6. When cleaning is complete, you see a message asking if you want to print a nozzle check pattern. If you want to check to see if the nozzles are clean, press OK and load a sheet of photo paper, then press Print to print the nozzle check.

If you don't want to print a nozzle check, press BACK to go back to the Maintenance Menu.

7. Check the pattern to see if there are any gaps in the lines.

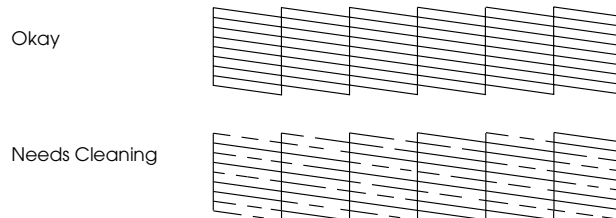



8. If there are gaps, press OK to clean the print head again. If there are no gaps, press BACK to go back to the Maintenance Menu.



Aligning the Print Head

If you have moved PictureMate and print quality is not as good as it was before—for example, you see misaligned vertical lines or light or dark horizontal banding—you may need to align the print head.

1. Make sure that the printer is turned on and no warnings or errors are displayed on the LCD panel.

2. Load a sheet of photo paper. See “Loading Paper” on page 17.
3. On the Main Menu, or after selecting photos, press Menu.
4. Press  or  to highlight Maintenance, then press .





5. Press  or  to highlight Align Print Head, then press .
6. Confirm the messages on the LCD panel, then press Print to start head alignment.

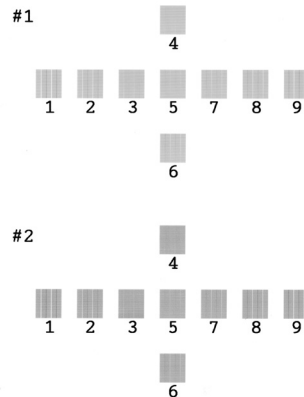

7. The following alignment sheet is printed.

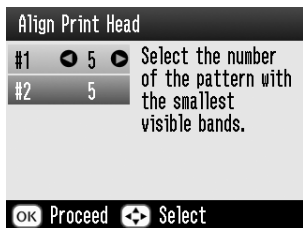

8. Look at the alignment pattern in each set and find the patch which is most evenly printed, with no noticeable streaks or lines.

9. Press  or  to highlight the number for the best pattern (1 to 9) in set #1, then press .



10. Press  or  to highlight the number for the best pattern (1 to 9) in set #2, then press OK.
11. Press OK to exit the alignment screen. The Maintenance Menu appears on the screen.

Cleaning the Printer

To keep your printer operating at its best, clean it thoroughly several times a year as follows.

1. Turn off the printer and unplug the printer's power cord.
2. Remove any paper from the paper feeder.
3. Use a soft brush to carefully clean away all dust and dirt from the paper feeder.
4. If the outer case or the inside of the paper feeder is dirty, wipe it with a soft, clean cloth dampened with mild detergent. Keep the output tray closed to prevent water from getting inside.
5. If the inside of the printer accidentally gets soiled with ink, wipe it off with a damp cloth.



Caution:

- Never use alcohol or thinner to clean the printer, as these chemicals can damage the components as well as the case.*
- Be careful not to get water on the printer mechanism or electronic components.*
- Do not use a hard or abrasive brush.*
- Do not spray the inside of the printer with lubricants. Unsuitable oils can damage the mechanism. Contact your dealer or a qualified service person if lubrication is needed.*

Troubleshooting

The solutions herein are for problems when printing directly from a memory card.

Error/Warning Messages

You can identify many common printer problems using the display on your printer's LCD panel.

Error

Display	Solution
Ink out. (T557) The genuine EPSON photo cartridge (T557) is recommended for replacement.	Replace the photo cartridge shown, with new one.
The internal pad that absorbs ink during head cleaning has become saturated. (T557) The genuine EPSON photo cartridge listed above is recommended for replacement.*	Replace the photo cartridge shown, with a new one.
Paper is not loaded correctly. Load the paper correctly, then press OK.	Load paper in the paper feeder, and press the OK button. The printer resumes printing.

A paper jam has occurred. Remove the sheet, and press OK.	Remove the jammed paper. See "Problems With Paper Feeding" on page 76 for details.
The photo cartridge cannot be recognized. The genuine EPSON photo cartridge (T557) is recommended for replacement.	Reinstall the photo cartridge.
Cannot recognize the memory card or disk.	Use a compatible and formatted memory card.
Close the cartridge compartment cover.	Close the cartridge compartment cover.
Service required. Parts inside your printer are at the end of their service life. See your printer's documentation for details.	Contact your dealer.
A printer error has occurred. See your printer's documentation.	Turn the printer off, and, after a few seconds, turn it on again. If the error is not cleared, contact your dealer.
The battery is empty. Connect the AC adapter.	Connect the AC adapter.

The battery temperature is abnormal. Turn the power off, then wait until the battery temperature decreases.	Turn the printer off, and wait until the battery temperature decreases.
The battery is defective. Change the battery.	Replace the battery with a new one.
External device is not connected or media is not inserted. Backup terminated.	Connect an external device or insert media.
Insufficient space on the external device. Backup cannot be performed.	Use an external device with sufficient space.
No memory card is inserted. Backup will be canceled.	Insert a memory card.
Backup cannot be performed when PictureMate is connected to a PC.	Disconnect a PC from the printer.
Bluetooth module error. Please remove and reinstall the module.	Disconnect the Adapter, then reconnect to the printer.

* The photo cartridge for this printer includes an internal pad to absorb ink discharged during head cleaning. In the event that the pad becomes saturated, the photo cartridge must be replaced even if there is ink remaining.

Warning

Error	Display	Solution
Ink low	You are running low on ink. For best results, use the genuine EPSON photo cartridge (T557).	Obtain a replacement photo cartridge.
Unknown ink cartridge installed	The installed photo cartridge differs from the genuine EPSON Photo cartridge for this printer. Your printouts may be different from those printed using genuine EPSON photo cartridge. Do you want to continue using the currently installed photo cartridge?	Replace the cartridge with a genuine EPSON photo cartridge, or select (Yes) to continue using the installed photo cartridge.
No data in Memory card	Memory card or disk was not inserted or cannot be recognized.	Check the memory card.
Printing from computer* ¹	Printing...	Start printing from the LCD panel after printing from the computer is completed.

Irregular external device.*2	Cannot recognize the device.	Connect on external storage device that is compatible with the printer.
Printer temperature error*3	<p>Temperature inside the printer is too high. Print quality may decline.</p> <p>To resolve this problem, see your printer's documentation.</p>	If you use the printer in places subject to direct sunlight, heat sources, or high temperature such as in the car, move the printer to the shade or a cool place. When the temperature inside the printer decreases, the error is canceled.
Bluetooth data error	Error in the data. The print results may not be perfect.	Check the data.
	Error in the data. The image cannot be printed.	Check the data.
	The image is too large to print with Bluetooth.	Print the data from a memory card or computer.
	The image is too complex to print with Bluetooth.	Check the data.

*1 This warning appears when the Print button is pushed, and it disappears after three seconds.

*2 This warning is displayed for one second every 3 seconds.

*3 This warning appears when the Print button is pushed, and disappears when the OK button is pushed. It appears only once during power on.

Printer Power Problems

LCD panel is off

- ❑ Press the On button to make sure that the printer is on.
- ❑ Turn off the printer and make sure that the power cord is securely plugged in.
- ❑ Make sure that your outlet works and is not controlled by a wall switch or timer.
- ❑ If you are using the optional battery, it may be empty, or it may not be installed all the way into the compartment. See “Charging the battery” on page 81 for instructions on charging the battery. See “Installing the battery” on page 80 for instructions on installing the battery.

LCD panel came on and then went out

The printer's voltage may not match the outlet rating. Turn off the printer and unplug it immediately. Then, check the printer labels.



Caution:

If the voltage does not match, DO NOT PLUG YOUR PRINTER BACK IN. Contact your dealer.

Power light came on and then went out

If you are using the optional battery, it may be empty, or it may not be installed all the way into the compartment. See “Charging the battery” on page 81 for instructions on charging the battery. See “Installing the battery” on page 80 for instructions on installing the battery.

Your PictureMate makes an unexpected noise when you turn it on or after it has been sitting for awhile.

PictureMate is performing routine maintenance.

PictureMate sounds as though it is printing, but nothing prints.

- ❑ PictureMate may be preparing to print.
- ❑ Make sure the print head nozzles are not clogged. To clean the print head, see “Cleaning the Print Head” on page 66.
- ❑ PictureMate won’t work properly if it’s tilted or at an angle. Place it on a flat, stable surface that extends beyond the printer base in all directions.
- ❑ Make sure paper is not jammed and is loaded correctly so it can feed into PictureMate. Make sure the handle is not resting on the paper. See “Loading Paper” on page 17 for paper loading instructions.

Print and Noise Problems

PictureMate makes an unexpected noise after you install a photo cartridge.

The first time you install the photo cartridge, PictureMate will charge its print head for about three minutes. Wait until charging finishes before you turn it off, or it may charge improperly and use more ink the next time you turn it on.

Your memory card does not work correctly.

- ❑ Make sure you are using a compatible memory card. See “Inserting Your Memory Card” on page 19.
- ❑ Make sure only one card is inserted at a time. PictureMate does not read from multiple cards at once.
- ❑ Photos must be in JPEG or Uncompressed TIFF format and taken with a DCF-compliant camera.
- ❑ PictureMate can recognize and print the first 999 photos on your memory card.

Photo Quality Problems**You see banding (light lines) in your prints.**

- ❑ The print head nozzles may need cleaning; see “Cleaning the Print Head” on page 66.
- ❑ Make sure the glossy side of the paper is face up.

- ❑ The photo cartridge may need replacing. To replace the cartridge, see “Replacing the Photo Cartridge” on page 50.
- ❑ The print head may need aligning; see “Aligning the Print Head” on page 67.

Your printout is blurry or smeared.

- ❑ Use the PictureMate Photo Paper to ensure proper saturation, absorption of ink, and quality.
- ❑ Make sure you load paper with the glossy side face up.
- ❑ Make sure your paper isn't damp or curled, or loaded face down (the glossy side should be face up). If it's damp or curled, load a new stack of paper.
- ❑ The print head may need aligning; see “Aligning the Print Head” on page 67.

Your printout is faint or has gaps in the image.

- ❑ The print head nozzles may need cleaning; see “Cleaning the Print Head” on page 66 for instructions.

- ❑ The photo cartridge may be old or low on ink. To replace the photo cartridge, see “Replacing the Photo Cartridge” on page 50.
- ❑ Make sure your paper isn’t damaged, old, dirty, or loaded face down. If it is, reload a new stack of paper with the glossy side up.

Colors in your photo are wrong or missing.

- ❑ Make sure the Color Effects setting is set to Color for color photos. See “Printing Photos in Black and White or Sepia” on page 31.
- ❑ The print head nozzles may need cleaning; see “Cleaning the Print Head” on page 66.
- ❑ The photo cartridge may be old or low on ink. To replace the cartridge, see “Replacing the Photo Cartridge” on page 50.
- ❑ Try turning on or off P.I.M, ExifPrint or Photo Enhance under the Auto Correct setting. See “Fixing Your Photos” on page 33.

Problems With Paper Feeding

Paper doesn’t eject fully or is wrinkled.

If it’s wrinkled when it ejects, the paper may be damp or too thin.

Paper doesn’t feed correctly or jams in the printer.

- ❑ Make sure the paper support is pulled up, all the way out, and is not leaning on the handle. The handle should be all the way down in back of PictureMate. Make sure the handle is not resting on the paper. See “Loading Paper” on page 17.
- ❑ If paper doesn’t feed, remove it from the paper support, reload it against the right edge, then slide the left edge guide against the paper (but not too tightly).
- ❑ If multiple pages feed at once, remove the paper from the paper support, separate the sheets, and carefully reload it.
- ❑ If paper jams, remove the paper, then press OK to clear the jam.

- ❑ Load paper glossy side up. Load up to a maximum of 20 sheets. Place the paper against the right edge and slide the edge guide against it, but not so tight that paper can't move.
- ❑ Don't load plain paper; this may damage PictureMate.
- ❑ Make sure you are using available paper for this printer (see "Consumable Products" on page 79). Store paper flat to help prevent curling.

Miscellaneous Printout Problems

The printer prints blank pages.

The print head may need cleaning. See "Cleaning the Print Head" on page 66.

The borders or layout are incorrect.

- ❑ Check your Layout setting to see if it is correct. See "Choosing a Layout" on page 28.
- ❑ If you have a border on one side of your photo but not the other, make sure the paper is positioned correctly in the paper support, all the way to the right. Slide the edge guide against the paper.

- ❑ Make sure the photo is not cropped. See "Cropping Your Photo" on page 32.
- ❑ If the subject of your photo is very close to the edge of the image, you can control the amount of image enlarged by the Borderless Expansion setting. See "Adjusting the amount of image enlarged during borderless printing" on page 29.

The wrong photo is printed.

- ❑ If your camera supports DPOF, you can pre-select photos so PictureMate will print only the ones you want. You can also de-select DPOF if you want to choose other photos. See "Printing Camera-Selected DPOF Photos" on page 27.
- ❑ If your camera is PictBridge- or USB DP-enabled, you can connect it to PictureMate and control printing from your camera. See "Printing From a PictBridge-Enabled Camera" on page 42.

Too many copies are printing.

Make sure that the Copies option is set to the number of copies you want to print.

Customer Support

Contacting Customer Support

If your Epson product is not operating properly and you cannot solve the problem using the troubleshooting information in your product documentation, contact customer support services for assistance. Check your Pan-European Warranty Document for information on how to contact EPSON Customer support. They will be able to help you much more quickly if you give them the following information:

- ❑ Product serial number
(The serial number label is usually on the back of the product.)
- ❑ Product model
- ❑ Product software version
(Click About, Version Info, or similar button in the product software.)
- ❑ Brand and model of your computer

- ❑ Your computer operating system name and version
- ❑ Names and versions of the software applications you normally use with your product

Technical Support Web Site

Go to <http://www.epson.com> and select the Support section of your local EPSON web site for the latest drivers, FAQs, manuals and other downloadables.

Epson's Technical Support Web Site provides help with problems that cannot be solved using the troubleshooting information in your printer documentation.

Options and Consumable Products

Options

Bluetooth Photo Print Adapter

Bluetooth unit C824***

Note:

The asterisk is a substitute for the last digit of the product number, which varies by location.

➔ See “Printing From a Bluetooth Device” on page 44

Lithium Ion Battery

An optional rechargeable battery means you can use PictureMate without the AC adapter.

Lithium Ion Battery C83107*

Note:

The asterisk is a substitute for the last digit of the product number, which varies by location.

For details on using the optional battery, see “Using the Optional Battery” on page 80.

Consumable Products

The following photo cartridge and Epson special media are available for your printer.

PictureMate PicturePack (PictureMate Photo Cartridge and 100 sheets of PictureMate Photo Paper)	T5570
PictureMate Photo Cartridge	T557
EPSON Premium Glossy Photo Paper 10 × 15 cm (4 × 6 in.)	S041706 S041692 S041729 S041730 S041750 S041758 S041761
EPSON Premium Semigloss Photo Paper 10 × 15 cm (4 × 6 in.)	S041765

Note:

☐ *The availability of special media varies by location.*

- ❑ Please check your local EPSON customer support website where to buy or visit your local dealer.
 - ➔ See “Contacting Customer Support” on page 78

Using the Optional Battery

Note:

- ❑ Install the battery after installing the first photo cartridge and after ink charging is finished.
- ❑ You cannot save data on the memory card to an external device when using the battery. Connect the AC adapter to PictureMate when you save data.
- ❑ When you copy data on a computer to your memory card, confirm that there is enough power in the battery. If the battery runs out, saving is canceled, and corrupted data may remain on the memory card.

For safety instructions for the battery, see “When using the optional battery” on page 10.

Installing the battery

Follow the steps below to install the battery.

1. Make sure that PictureMate is turned off.
2. Unplug the AC adapter from the printer.
3. Open the battery cover.

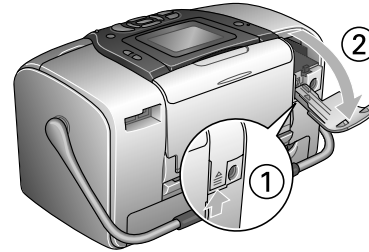

4. Insert the battery into the compartment in the direction shown below until it is fixed in place.

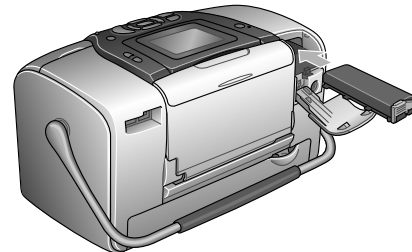

Note:

Push the battery all the way into the compartment so that it locks into place as shown below.

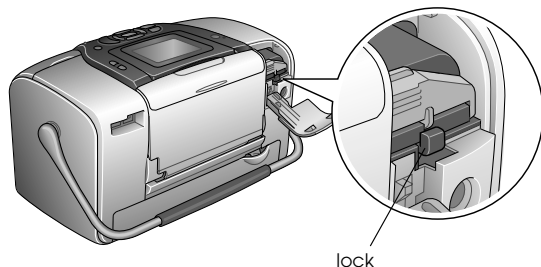

5. Close the battery cover.

Removing the battery

1. Make sure that PictureMate is turned off.
2. Open the battery cover.

3. Move down the battery latch and pull out it.

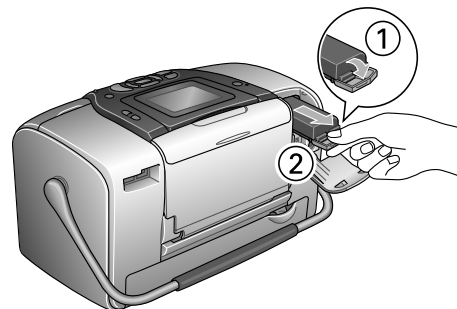



4. Close the battery cover.

Charging the battery

After installing the battery, charge the battery using the AC adapter.

1. Make sure that the battery is installed.
2. Connect the power cord and AC adapter, then plug in PictureMate.

When PictureMate is off, the power light blinks during charging. When the battery is fully charged, the power light turns off.

When PictureMate is on during charging,  icon blinks on the LCD panel. When the battery is fully charged,  icon appears.



Note:

The battery may not be charged correctly if the temperature of the operation is not guaranteed.

Checking the battery status

Using the LCD panel

The battery status is always displayed at the top right corner of the LCD panel.

Icon	Status
	Indicates low battery power
	Indicates battery power is running out. Charge the battery using the AC adapter.
	Indicates battery is charging

Battery performance

Charging Time	Approx. 2.5 hours at maximum
Continuous Print Time	Approx. 90 minutes
Number of Prints	Approx. 50 sheets (4 × 6 in.) *

* When printing from a Memory Stick with a fully charged, fresh battery, at room temperature. The number of sheets varies depending on the memory card, data size, and other conditions.

Auto Power Off

When the battery is used to power PictureMate, PictureMate will automatically turn off to save battery power if it is idle for about 15 minutes.

Note:

When a memory card is inserted and PictureMate is connected to a computer, it will not turn off automatically.

Printer Specifications

Printer Specifications

Printer

Dimensions	Storage Width: 256 mm (10.0 inches) Depth: 154 mm (6.1 inches) Height: 167 mm (6.6 inches)
	Printing Width: 256 mm (10.0 inches) Depth: 305 mm (12.0 inches) Height: 167 mm (6.6 inches)
Printable area	Border printing: 3 mm margin for all sides of paper Borderless printing: 0 mm margin
Paper tray capacity	20 sheets
Weight	2.8 kg (6.2 lb) without battery and photo cartridge

Electrical

Rating

Printer

	AC adapter operated	Optional battery operated
Input	DC 20 V, 1.6 A	DC14.4 V, 1.4 A

AC Adapter

Model	A361H
Input	AC100-240 V, 50-60 Hz, 0.8-0.4 A, 42 W
Output	DC 20 V, 1.68 A

Printer Operated by AC Adapter

		When not charging an optional battery		When charging an optional battery	
		AC 100-120V Input	AC 220-240 V Input	AC 100-120 V Input	AC 220-240 V Input
Power consumption using AC adapter	Continuous printing	Approx. 13 W	Approx. 14 W	Approx. 30 W	Approx. 30 W
	Sleep mode	Approx. 5.0 W	Approx. 5.5 W	Approx. 27 W	Approx. 28 W
	Stand-by mode	Approx. 0.7 W	Approx. 1.0 W	Approx. 26 W	Approx. 27 W
Input current using AC adapter (Continuous printing)		0.4 A	0.2 A	0.7 A	0.4 A

Environmental

Temperature	Operation: 10 to 35°C (50 to 95°F) Storage: -20 to 60°C (-4 to 140°F) 1 month at 40°C (104°F) 120 hours at 60°C (140°F)
Humidity	Operation: 20 to 80% RH Storage:*,** 5 to 85% RH

* Stored in a shipping container

** Without condensation

Built-in card slots

Card Slots		
	CF Type II card slot	Compatible with "CF+ and CompactFlash Specification 1.4"
	SmartMedia card slot	Compatible with "SmartMedia Standard 2003"
	Memory Stick/ MemoryStick PRO card slot	Compatible with "Memory Stick Standard version 1.3" Compatible with "Memory Stick Standard Memory Stick PRO Format Specifications version 1.0"
	SD/MMC card slot	Compatible with "SD Memory Card Specifications / PART1. Physical Layer Specification Version 1.0" Compatible with "MultiMediaCard Standard"
	xD-Picture Card Slot	Compatible with "xD-Picture Card™ Card Specification Version 1.20 Type M"

Compatible memory cards	CompactFlash SmartMedia* Memory Stick Memory Stick PRO Memory Stick Duo** Memory Stick PRO Duo** MagicGate Memory Stick MagicGate Memory Stick Duo** Microdrive SD (Secure Digital) Card MultiMediaCard miniSD card** xD-Picture Card xD-Picture Card Type M
Voltage Requirements	3.3 V 3.3 V/5 V Combined use Maximum current is 500 mA

* Maximum capacity is 128 MB.

** Adapter required.

Photo Cartridge

PictureMate Photo Cartridge (T557)

Color	Black, Cyan, Magenta, Yellow, Red and Blue
Cartridge life	Within 6 months of opening the package, at 25°C (77°F)
Temperature	Storage: -20 to 40°C (-4 to 104°F) 1 month at 40°C (104°F) Freezing:* -11°C (12.2°F)

* Ink thaws and is usable after approximately 3 hours at 25°C (77°F).

External Storage Devices

Connectivity	Universal Serial Bus Specifications Revision 1.1* Bit rate: 12 Mbps (Full speed device) Connector type: USB Series A Data Encoding: NRZI Recommended cable length: Less than 1.8 meters
---------------------	---

* Not all USB devices are supported. Contact your regional customer support for details.

Standards and Approvals

Printer

U.S. model:

Safety

UL60950-1

CSA No. 60950-1

EMC

FCC Part 15 Subpart B Class B

CSA C108.8 Class B

European model:

EMC

EMC Directive 89/336/EEC

EN 55022 Class B

EN 55024

Australian model:

EMC

AS/NZS CISPR22 Class B

AC Adapter

U.S. model:

Safety	UL 60950-1 CSA C22.2 No.60950-1
EMC	FCC Part 15 Subpart B Class B CSA C108.8 Class B

European model:

Safety	Low Voltage Directive 72/23/EEC EN60950-1
EMC	EMC Directive 89/336/EEC EN55024 EN61000-3-2 EN61000-3-3

Australian model:

Safety	AS/NZS 60950.1
EMC	AS/NZS CISPR22 Class B

Index

A

- Adjustment
 - photo, 33 to 35
- After printing, 59
- Aligning print head, 67 to 69
- All photos
 - printing, 22
- Auto Correct photo, 34

B

- Backup photos, 37 to 39
- Battery
 - buying, 79
 - using, 80 to 82
- Black and white printing, 31
- Blank pages, 77
- Bluetooth, 44, 79
 - Photo Print adapter, 15
- Blurry prints, 75
- Borderless photos, 28 to 29
- Borders, 28 to 29, 77

C

- Camera
 - printing from, 42
 - selected photos (DPOF), 27

- Cancel settings, 61
- Care of PictureMate, 65 to 69
- Carrying PictureMate, 56
- Cartridge status, 50
- CD
 - printing from, 40 to 42
 - saving files to, 37 to 39
- Cell phone
 - enhancing photos, 35
 - printing from, 44
- Change Personal Defaults, 61
- Charging ink, 74
- Choose photos, 21 to 29
- Cleaning
 - printer, 70
- Cleaning print head, 65 to 67
- Clogged nozzles, 65, 65 to 67
- Color
 - effects, 31
 - problems, 76
- Consumables, 79
- Contacting EPSON, 78
- Contact sheet, 28
- Contrast on LCD screen, 60
- Copying photos, 37 to 39
- Crop
 - photo, 32
- Customer support, 78

D

- Date
 - search photo, 24 to 25
 - stamp, 29 to 31
- Device
 - external, 37 to 39, 40 to 43
- Direct Print Setting, 42 to 43
- Display Setting, 58 to 59
- Double, 28
- DPOF (Digital Print Order Format), 27 to 29
- Drive
 - external, 37 to 39, 40 to 43
- Driver, 62 to 64

E

- Edge guide, 18
- Enhance photo, 33 to 35
- Error messages, 71
- Exif Print, 34
- EXT/IF port, 37 to 39
- External device, 37 to 39, 40 to 43

F

- Faint images, 75
- File formats, 16
- Fix photo, 33 to 35

Flash memory drive
 printing from, 40 to 42
 saving files to, 37 to 39
 Folder, 40 to 42
 Frame, 26 to 27, 36

G

Gaps in image, 75

H

Half Page, 28 to 29
 Handle, 17

I

Image
 formats, 16
 quality, 33 to 35, 75 to 76
 Incorrect colors, 76
 Index sheet, 28
 Ink, see Photo cartridge
 Installing the software, 62 to 64

J

Jams
 paper, 76
 JPEG, 16

L

Language, 60

Layout, 28 to 29, 48, 77
 LCD screen
 contrast, 60
 messages, 71

M

Maintenance, 65 to 69
 Manuals, 16
 Margins
 incorrect, 77
 selecting, 28 to 29
 Memory card
 adapter, 19
 compatibility, 19, 85
 inserting, 19
 problems, 71, 75
 removing, 20
 types, 19, 85
 Memory Stick, 19
 Microdrive, 19
 MiniSD card, 19
 Missing colors, 76
 MMC (MultiMediaCard), 19

N

Noise
 PictureMate, 74
 Nozzle check, 65, 67
 Nozzles
 cleaning, 65 to 67

O

On button, 19
 Output tray, 17

P

P.I.F., 26 to 27, 36
 Packing PictureMate, 56
 Paper
 buying types, 79
 feeding problems, 76, 76 to 77
 jam, 76
 tray, 17
 PDA
 printing from, 44
 Photo
 copying, 37 to 39
 cropping, 32
 formats, 16
 quality, 33 to 35, 75 to 76
 saving, 37 to 39
 Photo cartridge
 buying, 79
 ink level, 50
 replacing, 50, 50 to 55
 safety instructions, 12
 PhotoEnhance, 34
 Photo ID, 28
 PictBridge, 15, 42
 PictureMate PicturePack, 79
 PIM (PRINT Image Matching), 15, 34
 Power cable, 57

Preferences

- setting, 58 to 61

Print head

- aligning, 67 to 69
- cleaning, 65 to 67

PRINT Image Matching, 15, 34

Print quality problems, 75 to 76

Problems

- memory card, 75
- missing colors, 76
- paper feeding, 76, 76 to 77
- paper jam, 76
- photo quality, 75 to 76
- print quality, 75 to 76

Q

Quality, 33 to 35, 75 to 76

R

Range of photos, 23 to 24

Removing

- memory card, 20
- photo cartridge, 50

Replacing photo cartridge, 50, 50 to 55

Resetting, 61

Resolution, 16

S

Saving photo files, 37 to 39

SD (Secure Digital) card, 19

Sepia, 31

Sequence of photos, 23 to 24

Settings

- PictureMate, 58 to 61

Setup problems, 74

Several photos

- printing, 22 to 23

Slide show, 36

Small Image, 35

Small Photo, 35

SmartMedia card, 19

Smears, 75

Some photos

- printing, 22 to 24

Stamp

- date and time, 29 to 31

Status

- photo cartridge, 50

T

Technical support, 78

Thumb drive

- printing from, 40 to 42
- saving files to, 37 to 39

Thumbnails, 28

TIFF, 16

Time stamp, 29 to 31

Transporting PictureMate, 56

Traveling, 56

Troubleshooting, 71 to 77

Turning on printer, 19

U

Upper, 28

USB cable, 41 to 43, 56

USB DP (USB Direct Print), 15, 42

User's Guide, 16

X

xD Picture Card, 19

Z

Zip disk

- printing from, 40 to 42
- saving files to, 37 to 39

Zoom, 32