

LCD Digital Camera

QV-2400UX / QV-2900UX

User's Guide

PRINT
Image
Matching

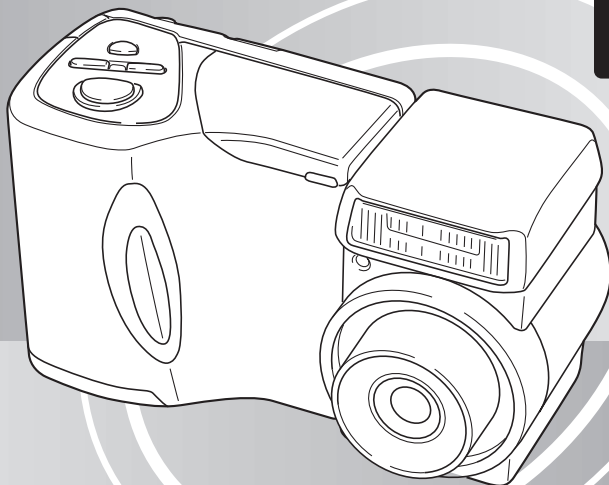

QV-2400UX

- All example procedures in this User's Guide are based on the QV-2400UX. The same procedures also apply to the QV-2900UX, unless specifically noted otherwise.
- Certain camera models may not be available in some geographic areas.

English

CASIO[®]

INTRODUCTION

To get the most out of your new CASIO Digital Camera, make sure you carefully read this manual and keep it on hand for future reference.

Unpacking

Check to make sure that all of the items shown below are included with your camera. If something is missing, contact your dealer as soon as possible.

Camera
QV-2400UX



QV-2900UX

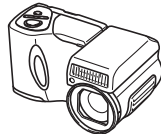

Soft case
(QV-2400UX only)



Lens cap/cap holder
The lens cap should be affixed to the lens of the camera when you unpack it.



Memory card (8 MB CompactFlash card)
Loaded in the camera when you purchase it.



Special video cable



Alkaline batteries
(4 AA-size batteries)

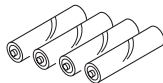

Strap



CD-ROM

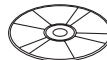

Special USB cable



Data Transfer Cable

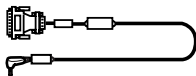

Basic Reference

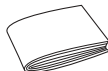

Bundled Software
User's Manual

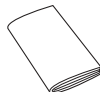

Best Shot scene List



Contents

E-2 INTRODUCTION

Unpacking	E-2
Contents	E-3
Quick Reference	E-7
Getting Ready	E-7
Recording an Image	E-8
Playback	E-9
Deleting Images	E-10
Features	E-12
Recording Features	E-13
Precautions	E-15
General Precautions	E-15
Operating conditions	E-16
Condensation	E-16
About the camera's backlight...	E-17

E-18 GETTING ACQUAINTED

General Guide	E-18
Front	E-18
Back	E-19
Terminals and Ports	E-20
Bottom	E-20

Lens	E-21
Changing the Lens Angle	E-21
Installing a Conversion Lens	E-22
Using a Filter	E-23
Lens Precautions	E-24
Monitor Screen Indicators	E-25
REC mode	E-25
PLAY mode	E-26
Changing the Contents of the Monitor Screen	E-27
Operation Indicator Lamp	E-28
REC mode	E-28
PLAY mode	E-29
Using the Bundled Accessories	E-30
Using the Lens Cap	E-30
Attaching the Strap	E-30
Using the Soft Case	E-31
Power Requirements	E-32
Loading Batteries	E-32
Battery Handling Precautions	E-35
Low Battery Indicator	E-35
Using AC Power	E-36
Turning the Camera On and Off	E-37
Power Save Settings	E-37
Memory Cards	E-39
Inserting a Memory Card into the Camera	E-39
Removing a Memory Card from the Camera	E-40
Formatting a Memory Card	E-41
Memory Card Precautions	E-42
IBM Microdrive Precautions	E-42
Menu Screens	E-44

Setting the Current Date and Time	E-45
Setting the Date and Time	E-45
Selecting the Date Format	E-46
Time Stamp	E-47

E-48 BASIC IMAGE RECORDING

Recording a Simple Snapshot	E-48
About the REC Mode Monitor Screen	E-50
About Auto Focus	E-50
Recording Precautions	E-50
Image Recording when the Battery is Low	E-51
Using Zoom	E-51
Using Optical Zoom	E-51
Using Digital Zoom	E-52
Using the Flash	E-53
Flash Status Indicators	E-54
Adjusting the Flash Intensity	E-54
Precautions when Using Flash	E-55
Selecting the Focus Mode	E-56
Using the Auto Focus Mode	E-56
Using the Macro Mode	E-57
Using the Infinity Mode	E-58
Using the Manual Focus Mode	E-58
Using Focus Lock	E-59
Specifying Image Size and Quality	E-60
Using the Self-timer	E-61
Exposure Compensation	E-62

E-64 OTHER RECORDING FUNCTIONS

Shooting Portraits	E-64
Shooting Landscapes	E-65
Shooting Night Scenes	E-66
Instant Setup Using the Best Shot Mode	E-67
Specifying the Location of Best Shot Mode	
Scene Images	E-69
Registering Your Own Scene Setups	E-70
Importing a Scene from the Best Shot Library on the CD-ROM	E-71
Recording a Movie	E-73
To record a movie using the normal mode	E-73
To record a movie using the past mode	E-74
Shooting Panoramas	E-75
Shooting at Fixed Intervals	E-76
Canceling an Interval Mode Timer Operation	E-78
Specifying the Exposure Mode	E-78
Program AE	E-78
Aperture Priority AE	E-79
Shutter Speed Priority AE	E-80
Manual Exposure	E-82
Quick Exposure Mode Selection	E-83
Selecting the Metering Mode	E-84
Quick Metering Mode Selection	E-85
Setting the Sensitivity Level	E-85
Using the Filter Function	E-86

Selecting White Balance	E-87
Adjusting White Balance Manually	E-87
Quick White Balance Selection	E-88
Enhancing Certain Colors	E-89
Turning the On-screen Grid On and Off	E-90
Specifying Outline Sharpness	E-91
Specifying Color Saturation	E-91
Specifying Contrast	E-92
Saving Uncompressed Images (TIFF Mode)	E-92
Specifying Power On Default Settings	E-93
Resetting the Camera	E-94
Using the Camera's Shortcut Features	E-95
Changing REC mode FUNCTION Menu Settings	
Using the Shortcut Buttons	E-95
To assign REC mode FUNCTION menu items	
to shortcut buttons	E-96
Directly Accessing the REC mode FUNCTION Menu	E-98
Cycling through REC mode FUNCTION Menu Settings	E-98

E-99 **PLAYBACK**

Basic Playback Operation	E-99
Playing a Movie	E-100
Playing a Panorama	E-101
Enlarging the Playback Image	E-102

Displaying the 9-image View	E-103
Selecting a Specific Image in the 9-image View	E-104
Displaying the Histogram	E-105
Using the Slide Show Feature	E-106
Resizing an Image	E-107
Cropping an Image	E-108

E-110 **DELETING IMAGES**

Deleting the Displayed Image	E-110
Deleting Selected Images	E-111
Deleting All Images in Selected Folders	E-112
Deleting All Unprotected Images	E-113

E-114 **MANAGING IMAGES**

Folders and Files	E-114
Folders	E-114
Files	E-115
Selecting a Folder for Playback	E-116
Protecting Images Against Deletion	E-116
Protecting Selected Images	E-116
Protecting and Unprotecting All Images	
in Selected Folders	E-117
Protecting and Unprotecting All Images	E-118

DPOF	E-119
Making DPOF Settings for Particular Images	E-119
Making DPOF Settings for Particular Folders	E-120
Making DPOF Settings of All Images on the Memory Card	E-121
PRINT Image Matching	E-122

E-123 OTHER SETTINGS

Turning the Monitor Screen Indicators On and Off ...	E-123
Changing the Display Language	E-124
Turning the Confirmation Beep On and Off	E-125

E-126 CONNECTING TO EXTERNAL EQUIPMENT

Connecting to a Television	E-127
Selecting the Video Output Signal Mode	E-128
Connecting the Wired Remote Controller to the Camera	E-129
Connecting an External Flash Unit (QV-2900UX Only)	E-129
External Flash Unit Requirements	E-129
Attaching an External Flash Unit	E-130
Connecting to a Computer	E-132
USB Port Connection (Windows, Macintosh)	E-133
Using a Serial Port Connection	E-134

Using a Memory Card to Transfer Image Data	E-135
Memory Card Data	E-136
DCF Protocol	E-136
Memory Card File Structure	E-137
Image Files Supported by the Camera	E-138
Precautions when Using a Memory Card on a Computer	E-139
Using the HTML Card Browser	E-140
Specifying the Card Browser Type	E-140
Viewing Card Browser File Contents	E-142
Saving Card Browser Files	E-145

E-146 REFERENCE

Camera Menus	E-146
REC mode	E-146
PLAY mode	E-147
Mode Settings	E-148
Settings in Each Mode	E-148
Recording Mode + Exposure Mode Combinations	E-149
Troubleshooting	E-150
Messages	E-153
Specifications	E-155

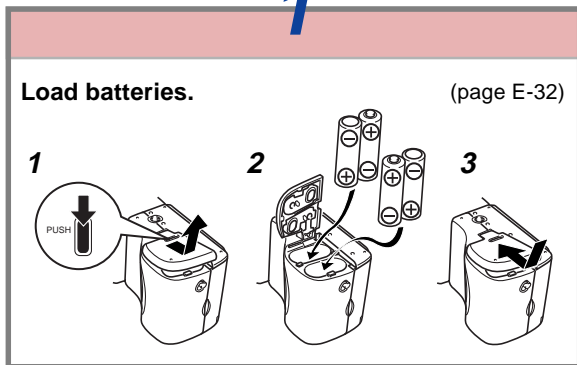
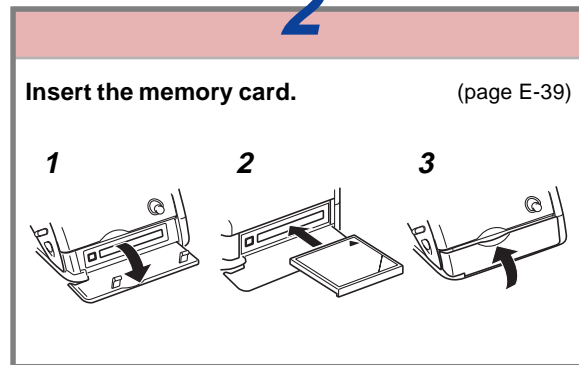
Getting Ready**1****2****3**

Recording an Image (page E-48)

4

Point the camera at the subject, compose the image on the monitor screen, and press the shutter release button half way to focus the image.

5

Press the shutter release button all the way down to record the image.

1

Remove the lens cap from the lens.

2

Slide the POWER ON/OFF switch to the right to turn on the camera.

3

Slide the REC/PLAY selector to "REC".

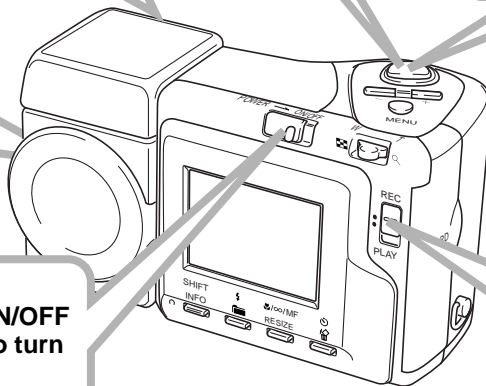

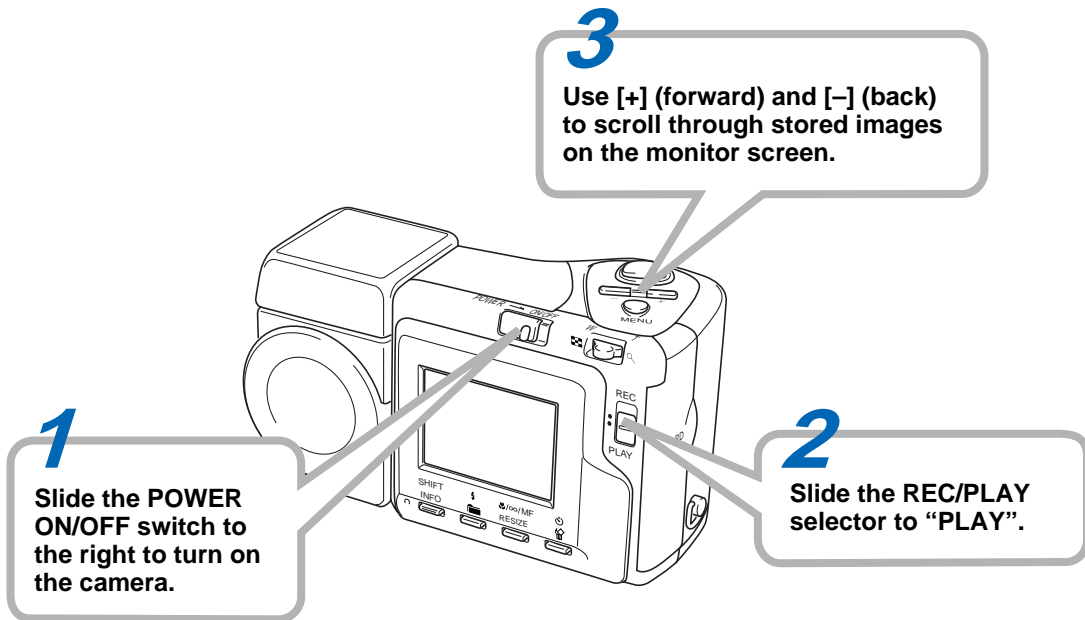
Playback (page E-99)

Deleting Images (page E-110)

1

Slide the **POWER ON/OFF** switch to the right to turn on the camera.

3

Use **[+]** (forward) and **[-]** (back) to scroll through stored images and display the one you want to delete.

6

Use **[+]** and **[-]** to move the cursor to "Yes" and then press the shutter release button to delete the image you selected.

2

Slide the **REC/PLAY** selector to "PLAY".

5

Double check to make sure you really want to delete the image you selected.

- You can exit the image delete operation by pressing MENU.

4

Press  .

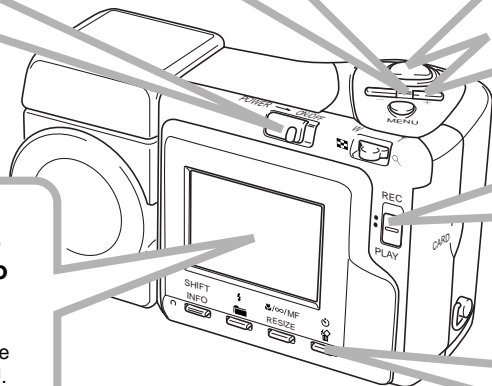

- CASIO COMPUTER CO., LTD. assumes no responsibility for any damage or loss resulting from the use of this manual.
- CASIO COMPUTER CO., LTD. assumes no responsibility for any loss or claims by third parties which may arise through the use of the QV-2400UX or the QV-2900UX.
- CASIO COMPUTER CO., LTD. assumes no responsibility for any damage or loss caused by deletion of data as a result of malfunction, repairs, or battery replacement. Be sure to back up all important data on other media to protect against its loss.
- *Windows and Internet Explorer are registered trademarks of Microsoft Corporation.*
- *Macintosh is a registered trademark of Apple Computer, Inc.*
- *CompactFlash™ and  logo are registered trademarks of SanDisk Corporation.*
- *The USB driver uses software by Phoenix Technologies Ltd.,
Compatibility Software Copyright © 1997
Phoenix Technologies Ltd., All Rights Reserved.*
- *IBM is a registered trademarks of International Business Machines Corporation.*
- *Other company, product and service names used herein may also be trademarks or service marks of others.*

Features

- High-resolution 2.11-megapixel CCD
- 1.8-inch low-glare color LCD (HAST)
- 12X zoom: 3X optical zoom, 4X digital zoom (QV-2400UX)
32X zoom: 8X optical zoom, 4X digital zoom (QV-2900UX)
- Swivel lens mechanism
Shoot from the angle you want without moving the camera body.
- External flash connectability (QV-2900UX only)
- Memory card image storage
Supports CompactFlash cards (CF TYPE I/II) and the IBM microdrive.
- Digital Print Order Format (DPOF)
Images can be printed easily in the sequence you want using a DPOF compatible printer. DPOF can also be used when specifying images and quantities for printing by professional print services.
- DCF Data Storage
DCF (Design rule for Camera File system) data storage protocol provides image inter-compatibility between the digital camera and printers.
- PRINT Image Matching support
Images include PRINT Image Matching data (mode setting and other camera setup information). A printer that supports PRINT Image Matching reads this data and adjusts the printed image accordingly, so your images come out just the way you intended when you recorded them.

- VIDEO OUT terminal
Connect to your TV for big-screen viewing of images.
- USB compatibility
Connect to your computer for quick and easy image exchanged.
- HTML File Card Browser
Images are displayed on your computer screen in a convenient format.
You can view a gallery of image thumbnails on your computer screen.

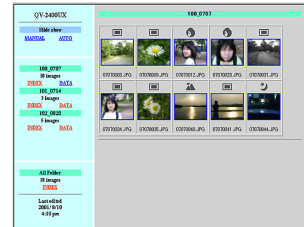

- Image management and manipulation software
The QV-2400UX or the QV-2900UX comes bundled with a CD-ROM disc that's packed with useful software. Photo Loader automates uploading of images to your computer, and Panorama Editor lets you stitch images together into panorama scenes. Other bundled applications include Internet Explorer (Web browser), Outlook Express (e-mail software), and QuickTime (movie viewer). You also get a copy of the Adobe Acrobat Reader PDF file reader for reading the user documentation on the CD-ROM disc.

Recording Features

Portrait Mode

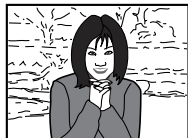

page E-64

Best Shot Mode



page E-67

Landscape Mode

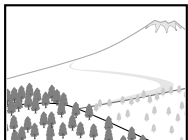

page E-65

Movie Mode



page E-73

Night Scene Mode



page E-66

Panorama Mode



page E-75

Interval Mode



page E-76

Histogram

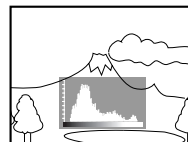

page E-105

Four exposure modes

Program AE, aperture priority AE, shutter speed priority AE, manual exposure

pages E-78 to E-83

Three metering modes

Multi-pattern, center weighted, spot

pages E-84

Four focus modes

Auto focus, macro, infinity, manual

pages E-56 to E-59

Precautions

General Precautions

Be sure to observe the following important precautions whenever using the QV-2400UX or the QV-2900UX.

All references in this manual to “this camera” and “the camera” refer to the CASIO QV-2400UX or QV-2900UX Digital Camera.

- Never try to take pictures or use the built-in display while operating a motor vehicle or while walking. Doing so creates the danger of serious accident.
 - Never try to open the case of the camera or attempt your own repairs. High-voltage internal components create the risk of electrical shock when exposed. Always leave maintenance and repair work up to authorized CASIO service providers.
 - Never fire the flash in the direction of a person operating a motor vehicle. Doing so can interfere with the driver’s vision and create the danger of accident.
 - Never fire the flash while it is too close to the subject’s eyes. Intense light from the flash can cause eye damage if it is fired too close to the eyes, especially with young children. When using the flash, the camera should be at least one meter from the eyes of the subject.
 - Keep the camera away from water and other liquids, and never let it get wet. Moisture creates the danger of fire and electrical shock. Never use the camera outdoors in the rain or snow, at the seashore or beach, in the bathroom, etc.
- Should foreign matter or water ever get into the camera, immediately turn power off, unplug the AC adaptor from the power outlet, and contact your dealer or nearest CASIO service provider. Using the camera under these conditions creates the danger of fire and electrical shock.
 - Should you ever notice smoke or a strange odor coming out of the camera, immediately turn power off and unplug the AC adaptor from the power outlet. Using the camera under these conditions creates the danger of fire and electrical shock. After making sure there is no more smoke coming from the camera, take it to your nearest CASIO service provider for repair. Never attempt your own maintenance.
 - At least once a year, unplug the AC adaptor from the power outlet and clean the area around the prongs of the plug. Dust build up around the prongs can create the danger of fire.
 - If the camera’s case should ever become cracked due to dropping it or otherwise subjecting it to rough treatment, immediately turn power off, unplug the AC adaptor from the power outlet, and contact your nearest CASIO service provider.
 - Never use the camera inside of an air craft or in any other areas where its use is prohibited. Doing so can result in an accident.
 - Physical damage and malfunction of this camera can cause the image data stored in its memory to be deleted. Be sure to always keep backup copies of data by transferring them to personal computer memory.

- Never open the battery compartment cover, disconnect the AC adaptor from the camera or unplug it from the wall socket while recording images. Doing so will not only make storage of the current image impossible, it can also corrupt other image data already stored in camera memory.

Operating conditions

- This camera is designed for use in temperatures ranging from 0°C to 40°C.
- Do not use or keep the camera in the following areas.
 - In areas subject to direct sunlight
 - In areas subject to high humidity or dust
 - Near air conditioners, heaters, or other areas subject to temperature extremes
 - Inside of a closed vehicle, especially one parked in the sun
 - In areas subject to strong vibration

Condensation

- When you bring the camera indoors on a cold day or otherwise expose it to a sudden change of temperature, there is the possibility that condensation can form on the exterior or on interior components. Condensation can cause malfunction of the camera, so you should avoid exposing it to conditions that might cause condensation.
- To keep condensation from forming, place the camera into a plastic bag before moving it into a location that is much warmer or colder than your current location. Leave it in the plastic bag until the air inside the bag has a chance to reach the same temperature as the new location. If condensation does form, remove the batteries from the camera and leave the battery compartment cover open for a few hours.

About the camera's backlight...

- The camera is equipped with a fluorescent light source to provide the back lighting for its LCD.
- The normal service life of the backlight is approximately six years, when the camera is used for about two hours a day.
- Should the LCD image appear abnormally dark, take the camera to your dealer or an authorized CASIO service provider to have the light source replaced. Note that you will be charged for this replacement.
- Under very cold conditions, the backlight may require more time than normal to light, or reddish bands may appear in the displayed image. These conditions do not indicate malfunction, and normal operation should return at higher temperatures.

GETTING ACQUAINTED

This section contains important information you should know when trying to operate the camera.

General Guide

The following illustrations show the names of each component, button, and switch on the camera.

Front

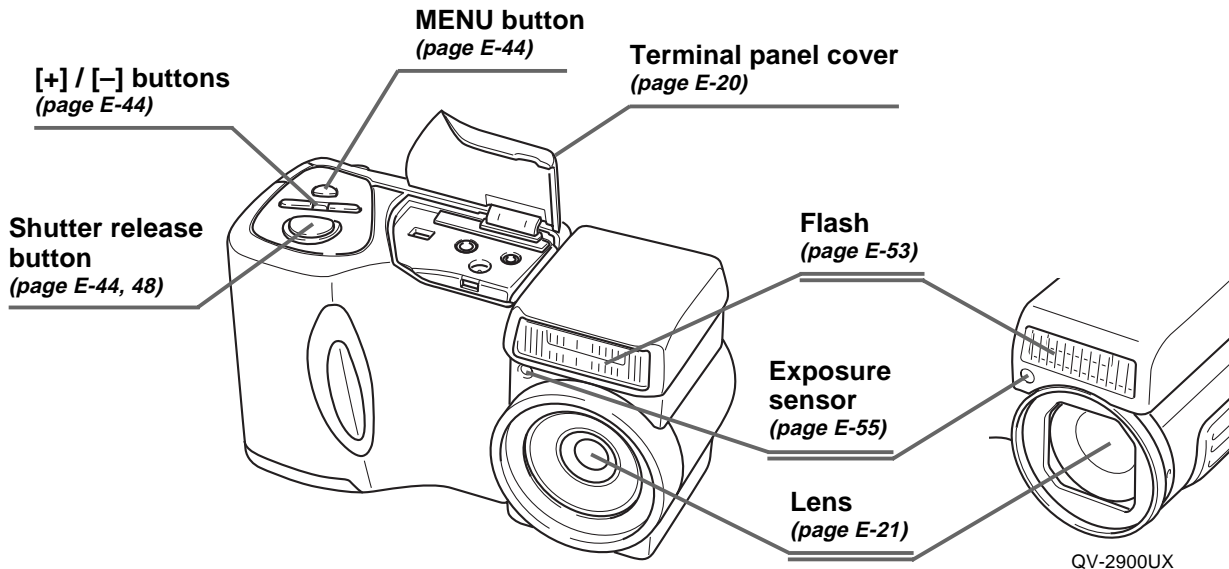

Back

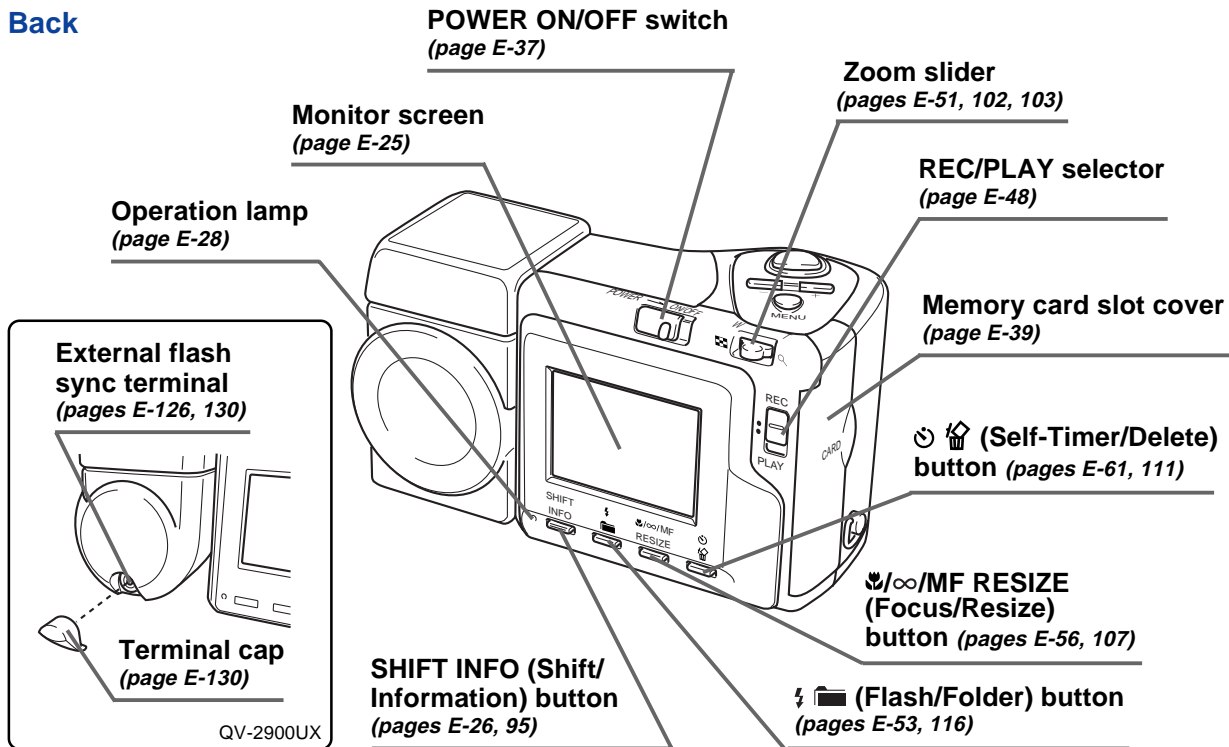

Terminals and Ports

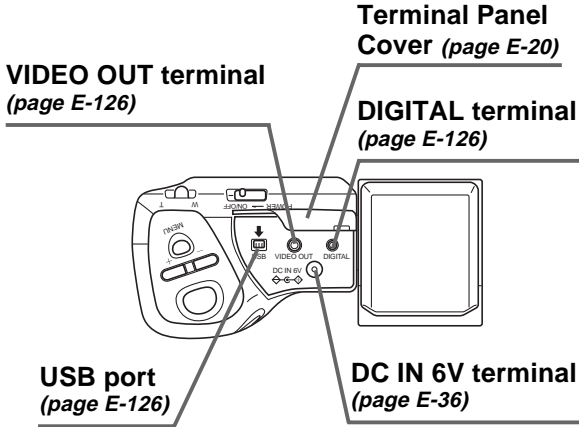

Open Terminal Panel Cover

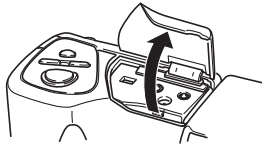

Bottom

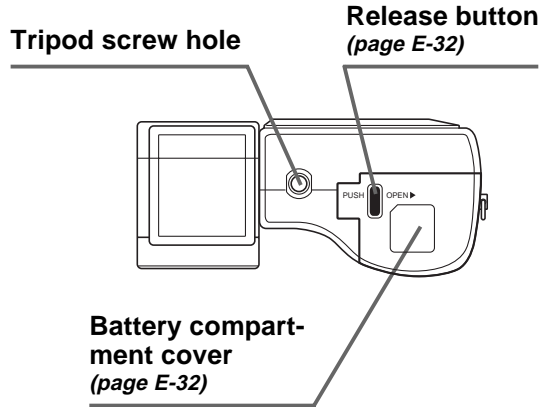

Lens

The swivel lens mechanism lets you easily aim at the angle you want, without changing the position of the camera body.

Changing the Lens Angle

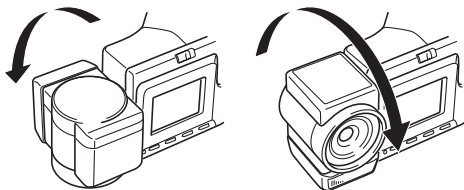

- Whenever you swivel the lens so it is pointing in the direction of the back of the camera, the image on the monitor screen is automatically adjusted so it shows a mirror image of what it picked up by the lens. This makes self-portrait images appear with the correct orientation when viewed on a display.

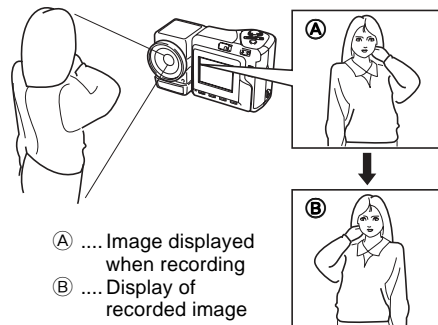

- (A) Image displayed when recording
 (B) Display of recorded image

IMPORTANT!

- Do not use undue force when rotating the lens mechanism and never try to force it past the point where rotation stops naturally. Rough handling can cause the lens mechanism to break and other damage to the camera.
- The proper orientation of the lens when you store the camera in its case depends on your camera model.
 - * QV-2400UX: Lens should be pointed forward.
 - * QV-2900UX: Lens should be pointed up.
- Never set the camera down while the lens is pointed downwards. Doing so can cause bending or other damage to the area around the lens.
- Always leave the lens cap on the lens except when you are actually recording images.

Installing a Conversion Lens

Optionally available conversion lenses change the focal distance, which provides enhanced telephoto or wide-angle capabilities. The method you should use to install a conversion lens depends on your camera model.

- QV-2400UX: You must install an optionally available lens adaptor (LU-8A) in order to use a conversion lens.
- QV-2900UX: A conversion lens can be installed directly, without an adaptor.
- Tele Conversion Lens LU-8T: 1.5X
Focusing distance when installed
QV-2400UX: Approximately 1m to ∞
QV-2900UX: Approximately 2.5m to ∞

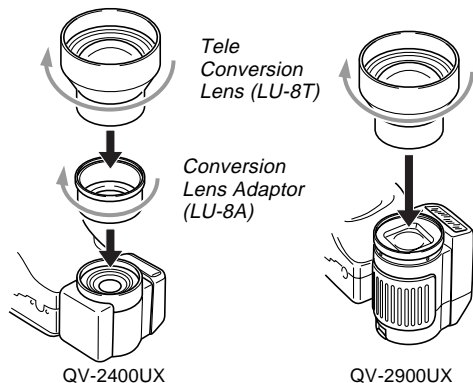

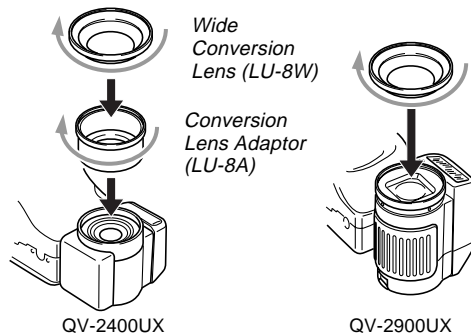

- Wide Conversion Lens LU-8W: 0.7X
Focusing distance when installed
QV-2400UX/QV-2900UX: Approximately 1cm to ∞



IMPORTANT!

- Be sure to use the Conversion Lens Adaptor whenever you install a conversion lens. If you don't, the lens will come into contact with the conversion lens when it extends from the camera, resulting in malfunction. (QV-2400UX only)
- Flash is disabled while a conversion lens is being used.

- Setting the camera to wide-angle zoom while the Tele Conversion Lens causes shadows around the periphery of the image. This is because the frame of the attached lens blocks some of the light coming into the lens. Because of this, you should always use telephoto zoom whenever you are using the Tele Conversion Lens.
 - The effects of camera movement are magnified while the Tele Conversion Lens is being used. Whenever you are using a conversion lens, install the cushion that comes with it and mount the camera on a tripod so it is secure.
 - Due to certain characteristics of the Wide Conversion Lens, you may notice some slight distortion in images recorded with it installed.
 - Make sure that  (Macro Mode) is selected as the focus mode whenever you are using the Wide Conversion Lens.
 - Note that optical zoom is restricted as shown below in the Macro Mode .
- * QV-2400UX: 1X fixed (QV-2400UX)
* QV-2900UX: 1X to 1.6X (QV-2900UX)

Using a Filter

- The lenses of both camera models are threaded.
- With the QV-2400UX, you can screw on an optionally available Conversion Lens Adapter (LU-8A) and then attach a commercially available lens filter.
- With the QV-2900UX, you can screw a commercially available lens filter directly to the lens, without using the Conversion Lens Adapter.

IMPORTANT!

- When using a lens filter with the QV-2400UX, be sure you first screw the optionally available Conversion Lens Adapter onto the lens. A filter attached directly to the lens of the QV-2400UX will come into contact with the convex surface of the lens and damage it.
- The designs of some filters can cause shadows around the periphery of the image.
- Auto focus and flash may not produce desired results while a filter is on the lens.
- Filters do not produce exactly the same results as those obtained with a film-based camera.
- Do not use multiple filters in combination.
- Use of the flash while a commercially available lens hood is installed may not produce desired results.

Lens Precautions

- Fingerprints, dust, or any other soiling of the lens can interfere with proper image recording. Never touch the lens with your fingers. You can remove dust particles from the lens surface by using a lens blower to blow them off. Next, wipe the surface of the lens with a soft lens cloth.
- The lens of the QV-2400UX extends from its body when you turn on power and retracts when you turn off power. Take care not to subject the lens to undue force or impact, and never set the camera face down so the lens is in contact with a tabletop, etc. Be sure to remove the lens cap before turning on the camera. If you turn on the QV-2400UX while the REC/PLAY selector is set to “REC” and its lens cap is attached, the message “LENS CAP!” appears on the monitor screen and power turns off automatically. If this happens, remove the lens cap and then turn on power.
- Never remove the batteries from the QV-2400UX or unplug its AC adaptor while the lens is extended. Doing so leaves the lens extended, and creates the risk of lens damage.

Monitor Screen Indicators

The following describes the different indicators and markings that appear on the camera's monitor screen.

REC mode

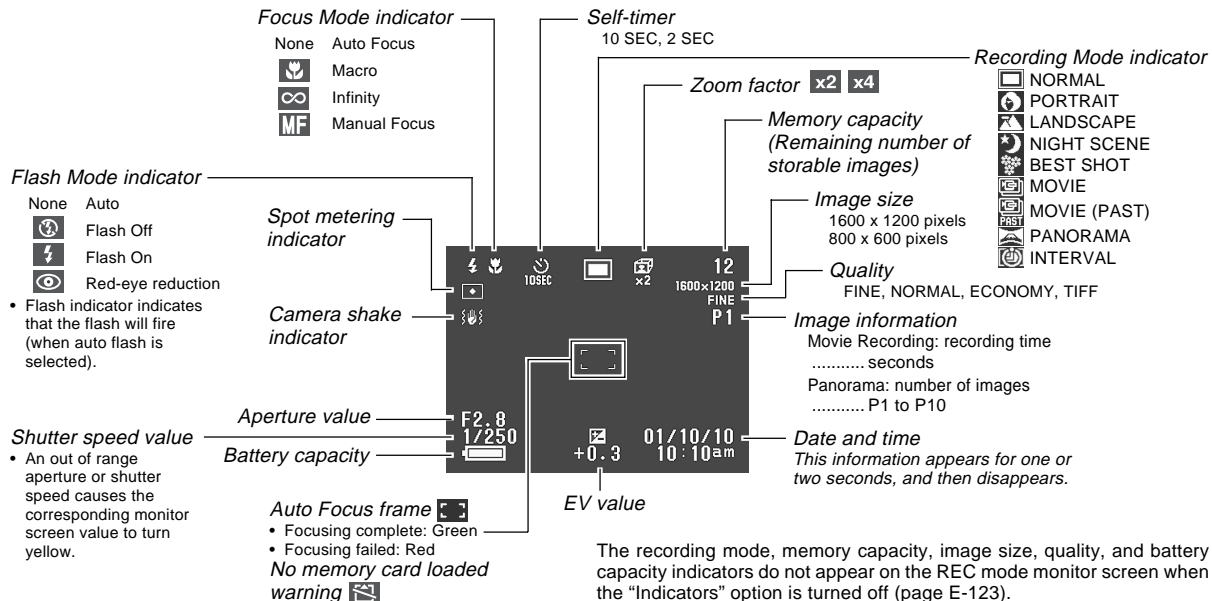

■ Screen when SHIFT INFO is pressed

Pressing SHIFT INFO also displays the FUNCTION menu (page E-95).

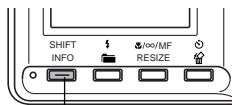

SHIFT INFO button

Metering Mode indicator

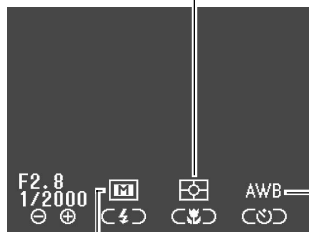

Exposure Mode indicator

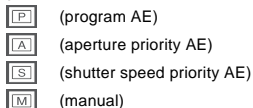

White balance

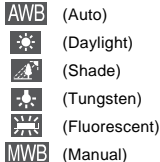

PLAY mode

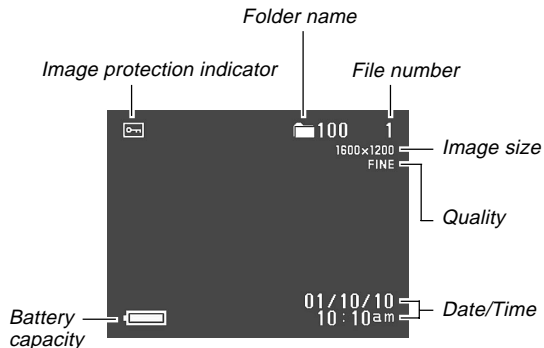

The above indicators do not appear on the PLAY mode monitor screen when the “Indicators” option is turned off (page E-123).

■ Screen when SHIFT INFO is pressed

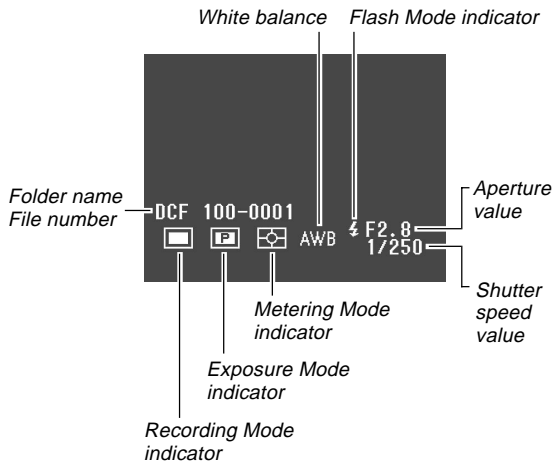

IMPORTANT!

- The above indicators may not appear when viewing images recorded using a different digital camera model.

Changing the Contents of the Monitor Screen

Each press of the SET/DISP button changes the contents of the monitor screen as shown below.

REC mode

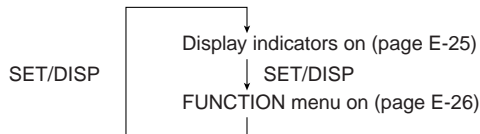

PLAY mode

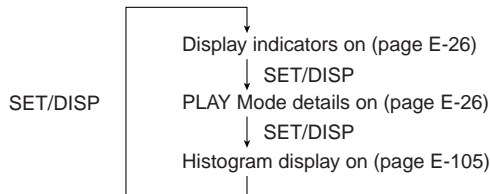

IMPORTANT!

- The histogram does not appear for movie images.

Operation Indicator Lamp

The Operation lamp shows the operational status of the camera as described below.

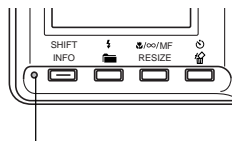

Operation lamp

REC mode

Lamp Color	On	Flashing
Green	Auto focus operation complete	Please Wait (after power on)
	Monitor screen turned off due to sleep state activation	Image store operation in progress
		Movie store operation in progress
		Self-timer countdown in progress
		Low battery
		Format operation in progress
Please Wait (after power off)		
Amber	Exposure warning	Flash is charging.
Red	Cannot focus	Memory card error
	Memory full	Memory card is not formatted
	Data save error	Cannot charge the flash

- The camera is ready to record when the lamp is off.

PLAY mode

Lamp Color	On	Flashing
Green	–	Please Wait (after power on)
		Delete operation in progress
		Image protection operation in progress
		Making DPOF settings
		Low battery
		Format operation in progress
		Please Wait (after power off)
Red	–	Memory card error
		Memory card is not formatted
		No memory card in the camera

Using the Bundled Accessories

Using the Lens Cap

Always keep the lens cap on the lens whenever you are not using the camera.

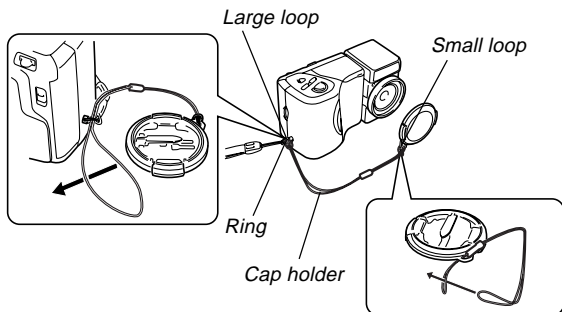

Attach the lens cap holder to the ring. This protects against accidental loss of the lens cap.

■ QV-2400UX Users

- Be sure to turn off camera power and let the lens retract into the camera before attaching the lens cap.
- Never turn on camera power with the lens cap affixed to the lens.

Attaching the Strap

Attach the strap as shown in the illustration below.

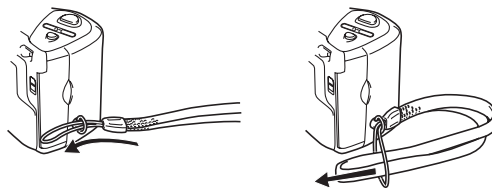

IMPORTANT!

- Be sure to keep the strap around your wrist when using the camera to protect against accidentally dropping it.
- The supplied strap is intended for use with this camera only. Do not use it for any other application.
- Never swing the camera around by the strap.

Using the Soft Case

Keep the camera in its soft case to protect it when not in use.

■ QV-2400UX

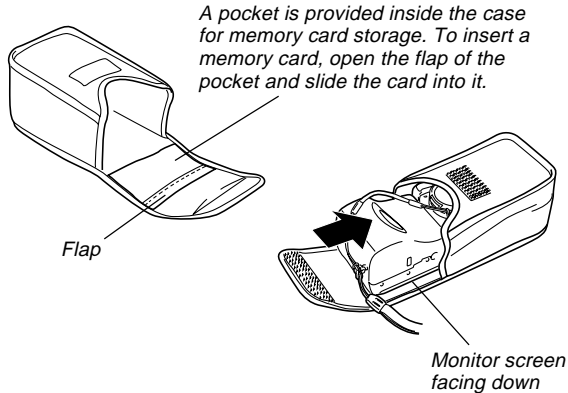

IMPORTANT!

- Never put any other objects besides the camera into the soft case.

Power Requirements

Your camera features a two-way power supply that lets you use either AA-size batteries or household AC current. A set of AA-size alkaline batteries is supplied with the camera. The other items listed below are available separately.

■ Batteries

- Four AA-size alkaline batteries: LR6
- Four AA-size lithium batteries: FR6
- Four AA-size nickel metal hydride rechargeable batteries: NP-H3

■ Household Current

- AC Adaptor: AD-C620
- AC Adaptor/Charger: BC-3HA

Loading Batteries

Make sure that camera power is turned off whenever loading or replacing batteries.

1. While holding down the release button on the battery compartment cover (on the bottom of the camera), slide the cover in the direction indicated by the arrow in the nearby illustration and open the cover.

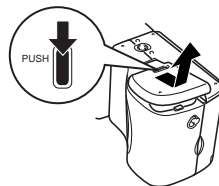

2. Load batteries with their \oplus/\ominus ends facing as shown in the nearby illustration.

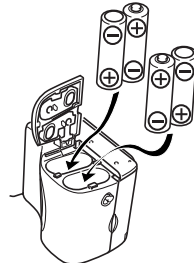

3. While holding down the release button, slide the battery compartment cover back to its original position to close it.



IMPORTANT!

- Never use manganese batteries. Use only the battery types specifically mentioned in this User's Guide.

● Battery Life Guidelines

The battery life guideline values given below indicate the amount of time at standard temperature (25°C) until power automatically turns off due to battery failure. They do not guarantee that batteries will provide the amount of service indicated. Low temperatures and continued use reduce battery life.

Type of Operation	AA-size Alkaline Batteries LR6	AA-size Lithium Batteries FR6	AA-size Ni-MH Batteries NP-H3
Continuous Playback	170 minutes	300 minutes	180 minutes
Continuous Recording	80 minutes (480 shots)	200 minutes (1200 shots)	120 minutes (720 shots)

- The above figures are approximations only.
- The above guidelines are based on the following battery types:
Alkaline: MX1500 (AA) DURACELL ULTRA
Lithium: Energizer
* Battery life varies with brand.
- Figures are based on continuous recording under the following conditions.
Flash turned off
One zoom slider switching between T (Telephoto) and W (Wide-angle)

Recording one image per minute under the above conditions reduces battery life to about one sixth of that noted above. Battery life is greatly affected by how much you use flash, zoom and other functions, and how long you leave power turned on.

● Tips for Prolonging Battery Life

- Use the  button to turn off the flash when you are not using it.
- You can also use the power save settings (page E-37) to protect against wasting battery power when you forget to turn off the camera.

● Alkaline Battery Life

The actual life of alkaline batteries is affected by a variety of factors, including the battery manufacturer, the amount of time the batteries spend in storage before you use them, temperature while you are recording, and photographic conditions. As a rule, we recommend the use of lithium batteries or Ni-MH batteries, which have longer lives than alkaline batteries.

The following examples show how alkaline battery life changes under different conditions.

photographic conditions → shooting conditions

Example 1: Intermittent use of the camera shortens battery life.

Conditions

- Temperature: 25°C
- Repeat of a cycle of recording of one shot per minute for 10 minutes, followed by one minute of playback, and a nine minutes of power off (power on, full lens extension, half lens contraction, full lens extension, image recording, power off)
- Flash on

Approximate Battery Life: 50 minutes (46 shots)

Example 2: Low temperatures shorten battery life.

Conditions

- Temperature: 0°C
- Repeat of a cycle of recording of one shot per minute for 10 minutes, followed by one minute of playback, and a nine minutes of power off (power on, full lens extension, half lens contraction, full lens extension, image recording, power off)
- Flash on

Approximate Battery Life: 12 minutes (11 shots)

● About rechargeable batteries

Use only the nickel-metal hydride batteries (NP-H3) that are available from your dealer as options for this camera. Proper camera operation is not guaranteed when other rechargeable batteries are used.

AC Adaptor/Charger : BC-3HA

Nickel-metal hydride batteries (4-battery set)/Quick Charger Set : BC-1HB4

Nickel-metal hydride batteries (4-battery set) : NP-H3P4

IMPORTANT!

- Be sure to keep all four batteries together as a set at all times, for both charging and powering the camera. Mixing batteries from different sets can shorten overall battery life and cause malfunction of the camera.
- Rechargeable batteries cannot be charged while they are loaded in the camera.

Battery Handling Precautions

Incorrect use or handling of batteries can cause them to leak or burst and create the danger of serious damage to your camera. Be sure to note the following important precautions to avoid problems with batteries.









- Use only LR6 (AM-3) type alkaline or FR6 type lithium or Ni-MH (nickel-metal hydride) dry cell batteries with this camera. Never mix old batteries with new ones. Doing so can result in bursting or leaking of batteries, creating the danger of fire or personal injury.
- Always make sure that the plus (+) and minus (-) ends of the batteries are facing correctly, as noted by the markings on the camera itself. Improper loading of batteries can result in bursting or leaking of batteries, creating the danger of personal injury or soiling of objects nearby.

- Remove batteries from the camera if you do not plan to use it for more than two weeks.
- Never recharge batteries, never allow direct connection between two ends of a battery, and never try to take batteries apart.
- Do not expose batteries to direct heat or dispose of them by burning. Doing so can create the danger of explosion.
- Never mix batteries of different types.

- Dead batteries are susceptible to leakage, which can cause serious damage to your camera. Remove batteries from the camera as soon as you notice they are dead.
- The batteries that power the camera normally become warm as they discharge.

Low Battery Indicator

The following shows how the battery capacity indicator on the monitor screen and the indicator display changes as battery power is used. Replace all four batteries as soon as possible after they go dead. If you continue to use the camera while the battery level is  or , camera power will automatically turn off.

Battery Capacity	High ←————→ Low
Monitor Screen	 →  →  → 

Using AC Power

Use the adaptor as shown below to power the camera from a household power outlet.

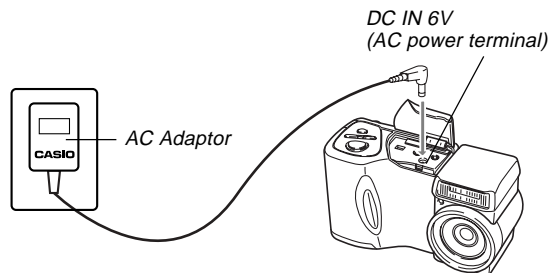

- AC Adaptor: AD-C620 (Option)
- AC Adaptor/Charger: BC-3HA (Option)
The BC-3HA functions both as an AC adaptor and as a charger unit for AA-size nickel metal hydride batteries. It comes complete with four rechargeable nickel metal hydride batteries. This AC adaptor/charger unit can be used with any household power outlet rated for 100V to 240V AC.



AC Adaptor precautions

- Never use an electrical outlet whose voltage is outside the rating marked on the AC adaptor. Doing so can create the danger of fire or electrical shock. Use only the optional AC adaptor specified for this camera.
- Do not allow the AC adaptor power cord to become cut or damaged, do not place heavy objects on it, and keep it away from heat. A damaged power cord creates the risk of fire and electrical shock.
- Never try to modify the AC adaptor power cord, or subject it to severe bending, twisting, or pulling. Doing so creates the risk of fire and electrical shock.
- Do not touch the AC adaptor while your hands are wet. Doing so creates the risk of electrical shock.
- Do not overload extension cords or wall outlets. Doing so creates the danger of fire and electrical shock.
- Should the cord of the AC adaptor become damaged (exposed internal wiring), request a replacement from an authorized CASIO service provider. A damaged AC adaptor cord creates the danger of fire or electrical shock.

- Be sure to turn off power before connecting or disconnecting the adaptor.
- Always turn camera power off before disconnecting the AC adaptor, even if the camera has batteries installed. If you don't, the camera will turn off automatically when you disconnect the AC adaptor. You also run the risk of damaging the camera whenever you disconnect the AC adaptor without first turning power off.
- The AC adaptor may become warm to the touch after extended periods of use. This is normal and is not cause for alarm.
- After using the camera, turn it off and unplug the adaptor from the AC outlet.
- The camera automatically switches over to AC adaptor powered operation whenever the AC adaptor is plugged into the camera.
- Always use the AC adaptor to power the camera whenever it is connected to a computer.

Turning the Camera On and Off

Sliding the POWER ON/OFF switch to the right toggles camera power on and off.

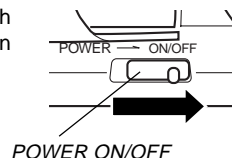

Power Save Settings

The settings described below let you specify sleep and auto power off trigger times that help to conserve valuable battery power.

AUTO POWER OFF

Auto Power Off turns off camera power if no operation is performed for five minutes in the PLAY mode. In the REC mode, you can specify an Auto Power Off trigger time of two or five minutes.

SLEEP

The monitor screen enters a sleep state if no operation is performed for a specified amount of time in the REC mode. Pressing any button immediately wakes up the monitor and restores normal operation. You can specify 30 seconds, 1 minute, or 2 minutes before the sleep state is triggered, or you can turn off this setting entirely.

To power save settings

1. Turn on the camera and slide the REC/PLAY selector to “REC”.
2. Press MENU.
3. Use [+] (down) and [-] (up) to select “FUNCTION”, and then press the shutter release button.
4. Use [+] (down) and [-] (up) to select the item whose settings you want to change, and then press the shutter release button.
 - To make auto power off settings, select “Auto Power Off”.
 - To make sleep settings, select “Sleep”.
5. On the screen that appears, use [+] and [-] to make the setting you want, and then press the shutter release button.

Auto power off settings: “2 min” “5 min”

Sleep settings: “Off” “30 sec” “1 min” “2 min”

- In the PLAY mode, Auto Power Off trigger time is fixed at five minutes.
- Sleep is disabled in the PLAY mode.
- Performing any button operation while the monitor is asleep immediately wakes it up and restores normal operation.
- The Auto Power Off setting is given priority if you have “2 min” set for both Sleep and Auto Power Off. This means that the camera turns off if you do not perform any operation for about two minutes in the REC mode.
- Auto Power Off is automatically disabled when under any one of the following conditions.
 - While a slideshow is playing
 - When you are performing operations on a computer, printer, or other external device connected to the camera’s DIGITAL terminal or USB port.
 - While the AC adaptor is connected to the camera

Memory Cards

This camera supports use of a CompactFlash memory card (CF TYPE I/II) or IBM microdrive for image storage. Note that all mentions of “memory” card in this manual refer both to a CompactFlash memory card and IBM microdrive, unless specifically noted otherwise.

IMPORTANT!

- Make sure that the power of the camera is turned off before you insert or remove a memory card.
- When inserting a memory card into the camera, make sure that the card is oriented correctly. Make sure that the correct side of the card is facing up, and that you insert the correct end of the card into the camera.

Inserting a Memory Card into the Camera

1. Open the memory card slot cover.

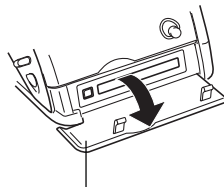

Memory card slot cover

2. As shown in the illustration, slide the memory card into the slot and push it in as far as it will go.

- If the Eject button is extended, press it in before sliding the memory card into the slot.

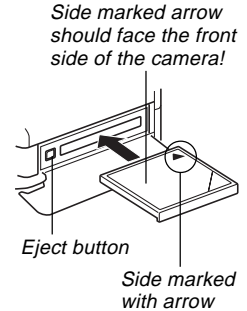

Side marked arrow should face the front side of the camera!

Eject button

Side marked with arrow

3. Close the memory card slot cover.

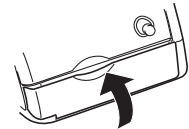

Removing a Memory Card from the Camera

1. Open the memory card slot cover.

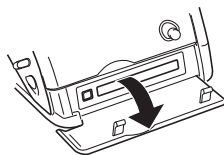

2. Press the eject button so it extends from the camera.

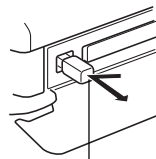

Eject button

3. Press the eject button once again to eject the card.

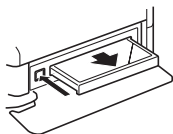

4. Remove the memory card.

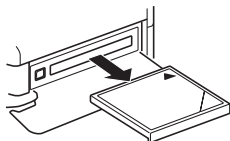

5. Close the memory card slot cover.

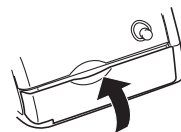

IMPORTANT!

- Insert only memory cards into the memory card slot. Inserting any other type of card can cause malfunction.
- Should water or any other foreign matter get into the memory card slot, immediately turn off power, unplug the AC adaptor, and contact your original retailer or nearest CASIO Service Provider.
- Never eject the CompactFlash card while the card slot is facing downwards. Doing so creates the danger of the CompactFlash card falling, which can corrupt image data on the card.
- Never remove the memory card from the camera while the operation lamp or card access lamp is flashing. Doing so can cause loss of recorded images or corruption of memory card data.

Formatting a Memory Card

You can format a memory card to delete all of the data stored on it.

IMPORTANT!

- Formatting a memory card deletes all images on the card, even if some or all of the images are protected (page E-112).
- Formatting a memory card deletes all Best Shot Mode scene sample images stored on it. After deleting the card, you have to import the scenes you want to the memory card (page E-72).
- Data deleted by a memory card format operation cannot be recovered! Be sure to carefully check and confirm that you no longer need the data stored in a memory card before formatting it.

1. Turn on the camera, and then use the REC/PLAY selector to select either “REC” or “PLAY”.

2. Select “Format” using one of the following two key operations, and then press the shutter release button.

If you are here	Select this on the menu screen
REC mode	“FUNCTION” → “SET UP” → “Format”
PLAY mode	“SET UP” → “Format”

- Use [+] and [-] to select each menu item, and press the shutter release button to advance to the next menu.
3. In response to the confirmation message that appears, use [+] and [-] to select “Yes” to format or “No” to exit, and then press the shutter release button.

Memory Card Precautions

- Images cannot be recorded with this camera unless a memory card is installed in it.
- Be sure to use only CASIO brand CompactFlash cards. Proper operation with other memory cards is not guaranteed.
- Static electricity, electrical noise, and other electrical phenomena can cause corruption or even total loss of the data stored on a memory card. Because of this, you should always make backup copies of important images on other media (magnetic optical disk, floppy diskette, computer hard disk, etc.).
- Memory card problems can be corrected by reformatting the memory card. Reformatting a memory card deletes all images stored on the card, but you can use a computer to copy the images you want to keep to the computer's hard disk before reformatting your card. If you plan to be recording images where you do not have access to a computer, it is a good idea to take along an extra memory card or two just in case you experience an unexpected memory card problem.

- Formatting is recommended for any memory card that you suspect contains corrupted image data (due to a DECODE ERROR, strange image colors, malformed images) or newly purchased memory cards.
- Before starting a format operation, load a full set of new batteries (alkaline or lithium) into the camera or connect the AC adaptor to power the camera. Interruption of camera power during the format operation results in improper formatting, making it impossible to use the memory card.

IBM Microdrive Precautions

Compatibility of the camera with the IBM microdrive has been confirmed by CASIO. However, you should note the following important points whenever using the IBM microdrive.

- Be sure to carefully read all of the documentation that comes with the microdrive before using it.
- Note that the microdrive becomes hot during normal use. Take care when removing it from the camera.
- Take care to avoid strong pressure on the label side of the microdrive when it is removed from the camera. Strong pressure can damage internal components and cause malfunction.

- Never turn off camera power or subject the camera to impact while the operation lamp is flashing. Doing so can cause malfunction of the microdrive.
- The microdrive is a very high precision device. Dropping the camera can result in malfunction of the microdrive, even though the camera is undamaged. Take extra care when handling the camera while the microdrive is installed.
- The microdrive has very large storage capacity. Because of this, certain operations can take a relatively long time to perform.
- The microdrive may not operate properly in areas where barometric pressure is low. Because of this, you should avoid using it at high altitudes.
- A microdrive consumes much more electrical power than a CompactFlash card. Depending on how a microdrive is used, it can greatly reduce battery life. When using alkaline batteries, certain operating conditions and certain battery brands can result in batteries going dead right after you install new ones. Whenever using a microdrive, we recommend that you use rechargeable nickel metal hydride batteries or lithium batteries to power the camera.
- When battery power is low, the amount of time required between shots may become longer. This longer interval is designed to protect the microdrive.

In case of microdrive malfunction....

- Contact your original microdrive retailer or the contact point noted in the microdrive documentation.
- CASIO does not provide any servicing or maintenance support for the microdrive.
- Note that CASIO assume no responsibility for any data loss you may suffer while using the microdrive.
- This camera supports use of both a CompactFlash card and the microdrive. Note, however, that ejecting a microdrive from the camera is relatively more difficult than ejecting a CompactFlash card.

Menu Screens

Pressing MENU displays the menu screen. The contents of the menu screen depend on whether you are in the PLAY mode or REC mode. The following procedure shows operation in the REC mode as an example.

1. Slide the **POWER ON/OFF** switch to the right to turn on the camera.
2. Slide the **REC/PLAY** selector to “REC”.
 - To perform a menu operation in the PLAY mode, slide the REC/PLAY selector to “PLAY”.
3. Press **MENU**.
4. Use **[+]** and **[-]** to select the item you want, and then press the shutter release button.
 - Make setting in accordance with the guidance messages that appear on the monitor screen.

[+] [-]: Item selection, page scrolling
 Shutter release button: Applies displayed setting
 MENU: Returns to previous screen

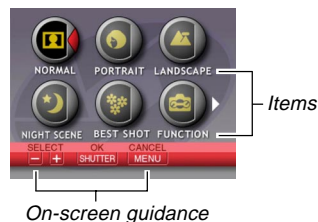

Example Displays

REC mode, page 1

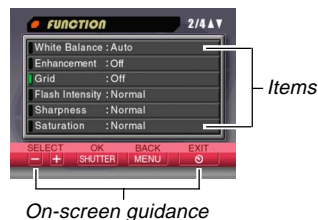

REC mode FUNCTION menu, page 2



- Pressing the   button is sometimes required to exit certain setting screens.
- See the “Camera Menus” on page E-146 for more information about menu contents.

Setting the Current Date and Time

Use the following procedures to set the current date and time, and to select the date format.

When you record an image, the time and date the image was shot is registered in accordance with data from the camera's built-in clock. You can even use the time stamp function to "stamp" the date and time inside the image.

IMPORTANT!

- The time and date settings are cleared if the camera is left for about 24 hours without battery and AC power being supplied. If this happens, restore power and make new time and date settings before using the camera again.
- A flashing time display indicates that the time and date (clock) settings have been cleared. Use the procedure on this page to make the correct time and date settings.
- If you do not set the camera's built-in clock to the current date and time, all images are recorded with the default date and time, which probably is not your correct current date and time. Be sure to correctly set the clock before you use the camera.

Setting the Date and Time

1. Turn on the camera, and then use the REC/PLAY selector to select either "REC" or "PLAY".
2. Press MENU.
3. Select "Date/Time" using one of the following two key operations, and then press the shutter release button.

If you are here	Select this on the menu screen
REC mode	"FUNCTION" → "SET UP" → "Date/Time"
PLAY mode	"SET UP" → "Date/Time"

- Use [+] and [-] to select each menu item, and press the shutter release button to advance to the next menu.

4. Select and change the digits on the screen to set the current date and time.

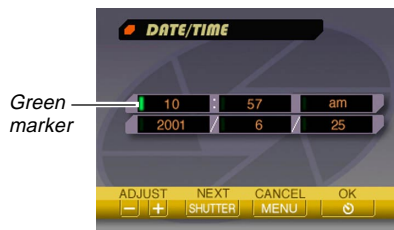

Shutter release button: Moves the green marker.
 [+] / [-]: Increases and decreases the currently selected digit.

5. Press to apply your settings.
6. Press to exit this setting screen.

Selecting the Date Format

You can use the following procedure to select one of the three different date formats.

1. Turn on the camera, and then use the REC/PLAY selector to select either “REC” or “PLAY”.
2. Press MENU.
3. Select “Date Style” using one of the following two key operations, and then press the shutter release button.

If you are here	Select this on the menu screen
REC mode	“FUNCTION” → “SET UP” → “Date Style”
PLAY mode	“SET UP” → “Date Style”

- Use [+] and [-] to select each menu item, and press the shutter release button to advance to the next menu.

- Use [+] and [-] to select the setting you want to use, and then press the shutter release button to apply it.

Example: October 18, 2001

Year/Month/Day: 01/10/18

Day/Month/Year: 18/10/01

Month/Day/Year: 10/18/01

- Press  to exit this setting screen.

Time Stamp

When it is turned on, the time stamp function digitally stamps the recording date and time in the lower right corner of each image as it is recorded. Note that once an image is stamped, the date and time cannot be deleted.



- Turn on the camera and then slide the REC/PLAY selector to “REC”.
- Press MENU.
- Select “FUNCTION” → “Time Stamp”, and then press the shutter release button.
- Use [+] and [-] to select the setting you want, and then press the shutter release button to apply it.

Example:

Date: October 18, 2001

Time: 1:25pm

Off : No time stamping

2001/10/18 : Year/Month/Day

18 1:25pm : Day Hour:Minutes

2001/10/18 1:25pm : Year/Month/Day Hour:Minutes