

# Canon

CANON INC.

U.S.A. ———— **CANON U.S.A., INC. NEW JERSEY OFFICE**  
100 Jamesburg Road, Jamesburg, NJ 08831 USA

**CANON U.S.A., INC. CHICAGO OFFICE**  
100 Park Blvd., Itasca, IL 60143 USA

**CANON U.S.A., INC. LOS ANGELES OFFICE**  
15955 Alton Parkway, Irvine, CA 92618 USA

**CANON U.S.A., INC. HONOLULU OFFICE**  
1020 Auahi Street, Bldg. #8, Honolulu, HI 96814 USA

- If you have any questions, call the Canon U.S.A. Information Center toll-free at 1-800-828-4040 (U.S.A. only).

CANADA ———— **CANON CANADA INC. NATIONAL HEADQUARTERS**  
6390 Dixie Road, Mississauga, Ontario L5T 1P7

**CANON CANADA INC. CALGARY**  
2828, 16th Street, N.E. Calgary, Alberta T2E 7K7

**CANON CANADA INC. MONTREAL**  
5990 Côte de Liesse, Quebec H4T 1V7

- If you have any questions, call the Canon Canada Information Center toll-free at 1-800-828-4040. (Canada only)

- Si vous avez des questions, veuillez téléphoner sans frais au Canada 1-800-828-4040. (Canada seulement)

MEXICO ———— **CANON MEXICANA, S. DE R.L. DE C.V.**  
Periferico Sur No. 4124 Col. Ex-Rancho de Anzaldo C.P. 01900  
México, D.F., México

CENTRO Y SURAMÉRICA ———— **CANON LATIN AMERICA, INC.**  
6505 Blue Lagoon Drive Suite 325 Miami FL 33126 USA

ASIA ———— **CANON HONGKONG COMPANY LTD.**  
9/F, The Hong Kong Club Building, 3A Chater Road, Central, Hong Kong



Printed on 70% reused paper.  
Document réalisé avec du papier recyclé à 70%.  
El papel aqui utilizado es 70% reciclado.

PUB.DIM-370  
0000A/ABXX

© CANON INC. 2001  
DY8-9120-263-000

PRINTED IN JAPAN  
IMPRIME AU JAPON  
IMPRESO EN JAPÓN

Canon ZR30MC

## DIGITAL VIDEO CAMCORDER Instruction Manual

## CAMESCOPE ET LECTEUR VIDEO NUMERIQUES Mode d'emploi

## VIDEOCAMARA Y GRABADORA DIGITAL Manual de Instrucciones

ENGLISH

E

FRANÇAIS

F

ESPAÑOL

Es

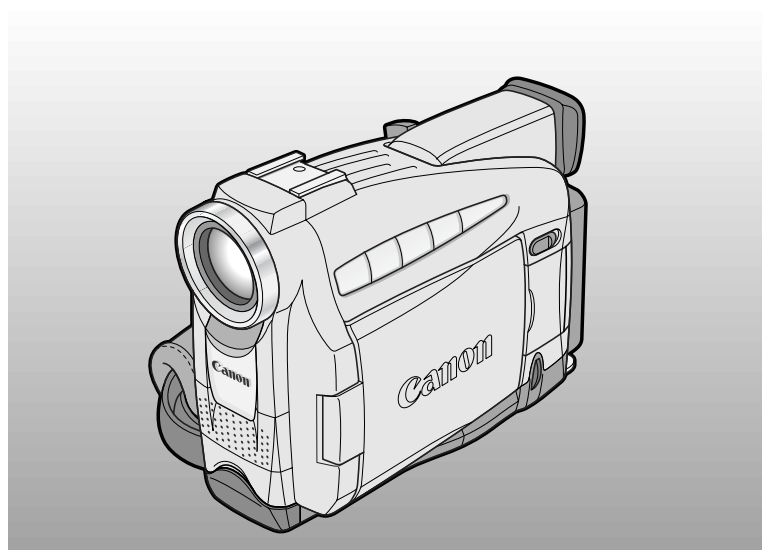

# Canon

## ZR30MC

Mini DV Digital Video Cassette

NTSC



# Important Usage Instructions

E

**WARNING:**



**TO REDUCE THE RISK OF FIRE OR ELECTRIC SHOCK, DO NOT EXPOSE THIS PRODUCT TO RAIN OR MOISTURE.**

**WARNING:**



**TO REDUCE THE RISK OF ELECTRIC SHOCK AND TO REDUCE ANNOYING INTERFERENCE, USE THE RECOMMENDED ACCESSORIES ONLY.**

**COPYRIGHT WARNING:**

**Unauthorized recording of copyrighted materials may infringe on the rights of copyright owners and be contrary to copyright laws.**

Digital Video Camcorder, ZR30 MC and Compact Power Adapter, CA-560

This device complies with Part 15 of the FCC Rules. Operation is subject to the following two conditions: (1) This device may not cause harmful interference, and (2) this device must accept any interference received, including interference that may cause undesired operation.

Note: This equipment has been tested and found to comply with the limits for class B digital device, pursuant to Part 15 of the FCC Rules. These limits are designed to provide reasonable protection against harmful interference in a residential installation. This equipment generates, uses and can radiate radio frequency energy and, if not installed and use in accordance with the instructions, may cause harmful interference to radio communications. However, there is no guarantee that interference will not occur in a particular installation. If this equipment does cause harmful interference to radio or television reception, which can be determined by turning the equipment off and on, the user is encouraged to try to correct the interference by one or more of the following measures:

- Reorient or relocate the receiving antenna.
- Increase the separation between the equipment and receiver.
- Connect the equipment into an outlet on a circuit different from that to which the receiver is connected.
- Consult the dealer or an experienced radio/TV technician for help.

Use of shielded cable is required to comply with class B limits in Subpart B of Part 15 of FCC Rules. Do not make any changes or modifications to the equipment unless otherwise specified in the manual. If such changes or modifications should be made, you could be required to stop operation of the equipment.

Canon U.S.A. Inc.  
One Canon Plaza, Lake Success, NY 11042, U.S.A.  
Tel No. (516)328-5600

**CAUTION:**

**TO PREVENT ELECTRIC SHOCK, MATCH WIDE BLADE OF PLUG TO WIDE SLOT, FULLY INSERT.**

Introduction

## Important Warning



The lightning flash with arrowhead symbol, within an equilateral triangle, is intended to alert the user to the presence of uninsulated "dangerous voltage" within the product's enclosure, that may be of sufficient magnitude to constitute a risk of electric shock to persons.

**CAUTION:**

**TO REDUCE THE RISK OF ELECTRIC SHOCK, DO NOT REMOVE COVER (OR BACK). NO USER-SERVICEABLE PARTS INSIDE. REFER SERVICING TO QUALIFIED SERVICE PERSONNEL.**



The exclamation point, within an equilateral triangle, is intended to alert the user to the presence of important operating and maintenance (servicing) instructions in the literature accompanying the product.

# IMPORTANT SAFETY INSTRUCTIONS

In these safety instructions the word “product” refers to the Canon Digital Video Camcorder ZR30 MC and all its accessories.

1. Read Instructions — All the safety and operating instructions should be read before the product is operated.
2. Retain Instructions — The safety and operating instructions should be retained for future reference.
3. Heed Warnings — All warnings on the product and in the operating instructions should be adhered to.
4. Follow Instructions — All operating and maintenance instructions should be followed.
5. Cleaning — Unplug this product from the wall outlet before cleaning. Do not use liquid or aerosol cleaners. The product should be cleaned only as recommended in this manual.
6. Accessories — Do not use accessories not recommended in this manual as they may be hazardous.
7. Avoid magnetic or electric fields — Do not use the camera close to TV transmitters, portable communication devices or other sources of electric or magnetic radiation. They may cause picture interference, or permanently damage the camera.
8. Water and Moisture — Hazard of electric shock — Do not use this product near water or in rainy/moist situations.
9. Placing or Moving — Do not place on an unstable cart, stand, tripod, bracket or table. The product may fall, causing serious injury to a child or adult, and serious damage to the product.  
A product and cart combination should be moved with care. Quick stops, excessive force, and uneven surfaces may cause the product and cart combination to overturn.
10. Power Sources — The CA-560 Compact Power Adapter should be operated only from the type of power source indicated on the marking label. If you are not sure of the type of power supply to your home, consult your product dealer or local power company. Regarding other power sources such as battery power, refer to instructions in this manual.
11. Polarization — The CA-560 Compact Power Adapter is equipped with a polarized 2-prong plug (a plug having one blade wider than the other). The 2-prong polarized plug will fit into the power outlet only one way. This is a safety feature. If you are unable to insert the plug fully into the outlet, try reversing the plug. If the plug still fails to fit, contact your electrician to replace your obsolete outlet. Do not defeat the safety purpose of the polarized plug.
12. Power Cord Protection — Power cords should be routed so that they are not likely to be walked on or pinched by items placed upon or against them. Pay particular attention to plugs and the point from which the cords exit the product.
13. Outdoor Antenna Grounding — If an outside antenna is connected to the product, be sure the antenna is grounded so as to provide some protection against voltage surges and built-up static charges. Section 810 of the National Electrical Code, ANSI / NFPA No. 70—1984, provides information with respect to proper grounding of the mast and supporting structure, grounding of the lead-in wire to an antenna discharge unit, size of grounding conductors, location of antenna discharge unit, connection to grounding electrodes, and requirements for the grounding electrode. See figure 1.



E

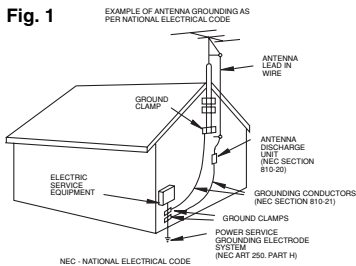

14. **Lightning** — For added protection of this product during a lightning storm, or when it is left unattended and unused for long periods of time, disconnect it from the wall outlet and disconnect the antenna. This will prevent damage to the product due to lightning and power-line surges.
15. **Power Lines** — An outside antenna system should not be located in the vicinity of overhead power lines or other electric light or power circuits, or where it can fall into such power lines or circuits. When installing an outside antenna system, extreme care should be taken to keep from touching such power lines or circuits as contact with them might be fatal.
16. **Overloading** — Do not overload wall outlets and extension cords as this can result in a risk of fire or electric shock.
17. **Objects and Liquid Entry** — Never push objects of any kind into this product through openings as they may touch dangerous voltage points or short out parts that could result in a fire or electric shock. Be careful not to spill liquid of any kind onto the product.
18. **Servicing** — Do not attempt to service this product yourself as opening or removing covers may expose you to dangerous voltage or other hazards. Refer all servicing to qualified service personnel.
19. **Damage Requiring Service** — Disconnect this product from the wall outlet and all power sources including battery, and refer servicing to qualified service personnel under the following conditions:
  - a. When the power-supply cord or plug is damaged.
  - b. If any liquid has been spilled onto, or objects have fallen into, the product.
  - c. If the product has been exposed to rain or water.
  - d. If the product does not operate normally even if you follow the operating instructions. Adjust only those controls that are covered by the operation instructions. Improper adjustment of other controls may result in damage and will often require extensive work by a qualified technician to restore the product to its normal operation.
  - e. If the product has been dropped or the cabinet has been damaged.
  - f. When the product exhibits a distinct change in performance. This indicates a need for service.
20. **Replacement Parts** — When replacement parts are required, be sure the service technician has used replacement parts that are specified by Canon or that have the same characteristics as the original part. Unauthorized substitutions may result in fire, electric shock or other hazards.
21. **Safety Check** — Upon completion of any service or repairs to this product, ask the service technician to perform safety checks to determine that the product is in safe operating order.

# Contents

## Introduction

Important Usage Instructions .....	2
IMPORTANT SAFETY	
INSTRUCTIONS .....	3
Thank you for Choosing a Canon .....	7
Introducing the ZR30 MC .....	8

## Mastering the Basics

Finding Your Way Around the ZR30 MC ..	9
<b>~ Preparations ... ~</b>	
Powering Your Camcorder .....	12
Loading a Cassette .....	17
<b>~ Basic Recording ... ~</b>	
Basic Recording .....	19
Zooming .....	23
Using the LCD Screen .....	24

<b>~ Basic Playback ... ~</b>	
Playing Back a Cassette .....	27
Connections for Playback on a	
TV Screen.....	31
Tips for Making Better Videos .....	34

## Using the Full Range of Features

<b>~ General ... ~</b>	
Turning the Image Stabilizer Off .....	36
Using the Menus .....	37
Using the Wireless Controller .....	45
Adjusting the Selectable Color	
Light-up Buttons .....	48
<b>~ For Recording ...~</b>	
Setting the Date and Time .....	49
Taking Still Pictures to a Cassette.....	52

Searching and Reviewing While	
Recording .....	54
Using the Various Recording	
Programs.....	55
Using Digital Effects .....	59
Using the Multi-Image Screen .....	64
Audio Recording .....	66
Setting the Self-Timer .....	68
Using the VL-3 Video Light	
(optional) .....	70
Using the DM-50 Microphone	
(optional) .....	71
<b>~ When Making Manual Adjustments ...~</b>	
Using AE Shift .....	72
Setting the Shutter Speed .....	73
Adjusting Focus Manually .....	75
Setting the White Balance .....	76

<b>~ For Playback ...~</b>	
Displaying Date, Time and Camcorder Data	
(Data Code) .....	78
Searching the Tape (Photo Search/ Date Search) .....	81
Returning to a Pre-Marked Position .....	82

## Editing

Editing to a VCR .....	83
Dubbing to/from a Cassette with Digital	
Video Equipment .....	84
Recording from a VCR, TV or Analog	
Camcorder (Analog Line-in) .....	86
Recording Over Existing Scenes	
(AV Insert Editing).....	88
Audio Dubbing .....	91
Setting the Audio Mix .....	94
Connecting to a PC .....	96

E

Introduction

Contents, cont.

## Contents, cont.

### E

#### Using a Memory Card

Memory Card Introduction .....	97
Recording Still Images to a Memory Card .....	101
Recording an Image from a Cassette as a Still Image .....	103
Recording from Another DV Device as a Still Image .....	104
Viewing Still Images .....	105
Preventing Accidental Erasure (Protect) .....	107
Erasing Still Images .....	108
Combining Images and Recording Them to a Cassette (Card Mix) .....	110
Copying Still Images from a Cassette....	113
Copying Memory Card Still Images to a Cassette .....	114





Marking a Still Image for Printing (Print Mark) .....	115
Formatting a Memory Card.....	116
Other Information and Precautions .....	117

#### Additional Information







Preparing the Camcorder.....	120
Notes on Using the Batteries.....	122
Maintenance .....	125
Troubleshooting.....	129
The ZR30 MC System Diagram .....	133
Optional Accessories .....	134
Screen Displays .....	137
Specifications .....	144
Index .....	145
Menu at a Glance .....	148

#### For quick reference

In addition to the contents and index please refer to:

- Finding Your Way Around the ZR30 MC (  9)
- Screen displays (  137)
- Troubleshooting — in case you run into any problems (  129)
- Menu at a Glance (  148)

Symbols used in this instruction manual:

-  : Reference page numbers
-  : Functions that can be operated from the body of the camcorder
-  : Functions that can be operated from the wireless controller
-  : Supplementary notes for camcorder operation
-  : Operation confirmation beeps (  22)

- Capital letters are used to refer to settings displayed in the menus and buttons labeled on the camcorder itself, e.g. Press the MENU button.

The serial number of this product may be found on the bottom of the camcorder. No others have the same serial number as yours. You should record the number and other vital information here and retain this book as a permanent record of your purchase to aid identification in case of theft.

Date of Purchase  
Dealer Purchased From  
Dealer Address  
Dealer Phone No.  
Model Name ZR30 MC  
Serial No.

# Thank you for Choosing a Canon





First, we'd like to thank you for purchasing this Canon camcorder. Its advanced technology makes it very easy to use — you will soon be making high-quality videos which will give you pleasure for years to come.

To get the most out of your new camcorder, we recommend that you read this manual thoroughly — there are many sophisticated features which will add to your recording enjoyment.

## Getting started

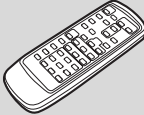
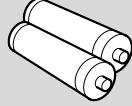
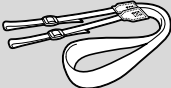
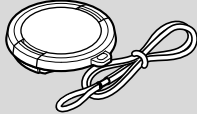
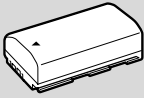
To get started we suggest that you master the basic operations of the camcorder first, before moving on to use its full range of features.

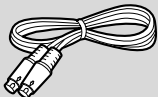
Your camcorder is supplied with the following accessories:

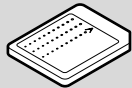
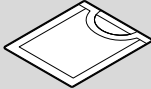
<p>WL-D77 Wireless Controller</p> 	<p>Two AA batteries</p> 
<p>SS-700 Shoulder Strap</p> 	<p>Lens cap and lens cap cord</p> 
<p>BP-512 Battery Pack</p> 	<p>CA-560 Compact Power Adapter (including AC power cable)</p> 
<p>Lithium button battery</p> 	<p>S-150 S-video Cable</p> 
<p>STV-250N Stereo Video Cable</p> 	<p>MMC-8M MultiMediaCard (with pre-recorded sample images)</p> 
<p>Soft case for MultiMediaCard</p> 	

E

Introduction

# Introducing the ZR30 MC

E

## IEEE 1394 DV Terminal



canon connects  
plug and edit

Using a DV cable, connect the ZR30 MC to a PC equipped with a DV terminal and transfer your original images to your PC.

## Extended Recording Time Function

Record for 1.5×, 2× or 3× longer than when in SP mode – up to 4 hours on an 80 minute tape.

## Memory Card

Record, manage and store still images on a MultiMediaCard or a high-capacity SD Memory Card. (Both cards are inserted into the same slot in the camcorder.) Combine still images recorded on the card with your original movies or still images. Also great for easy transfer of still images to a PC.

## Progressive Photo

Lets you record vivid, virtually blur-free still images of moving subjects onto a memory card.

## Still Photos



Just press the photo button to capture still pictures.

## 2.5" LCD Screen

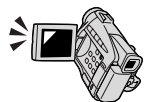

A 2.5" LCD screen makes it easy for you to shoot colorful, well composed video. It is also great for playback.

## Image Stabilizer



Stabilizes your recordings even in long telephoto shots.

## 10× Lens and 40× (Card)/200× (Tape) Digital Zoom

## Advanced Accessory Shoe

Allows the Canon Video Light VL-3 or the Directional Stereo Microphone DM-50 (both optional) to be easily attached and powered by the camcorder's own power source.

## Digital Effects



Advanced digital technology allows you to add special effects during recording or playback. Display 4, 9 or 16 still images at once with the multi-image screen.

## Selectable Color Light-up Buttons

## Audio Dubbing/AV Insert Editing



Add new sound to original sound, or replace original sound and images on a pre-recorded tape.

## Analog Line-in Recording

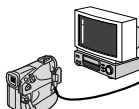

Connect to a VCR or analog camcorder and record onto a DV tape in the ZR30 MC.



# Finding Your Way Around the ZR30 MC

E

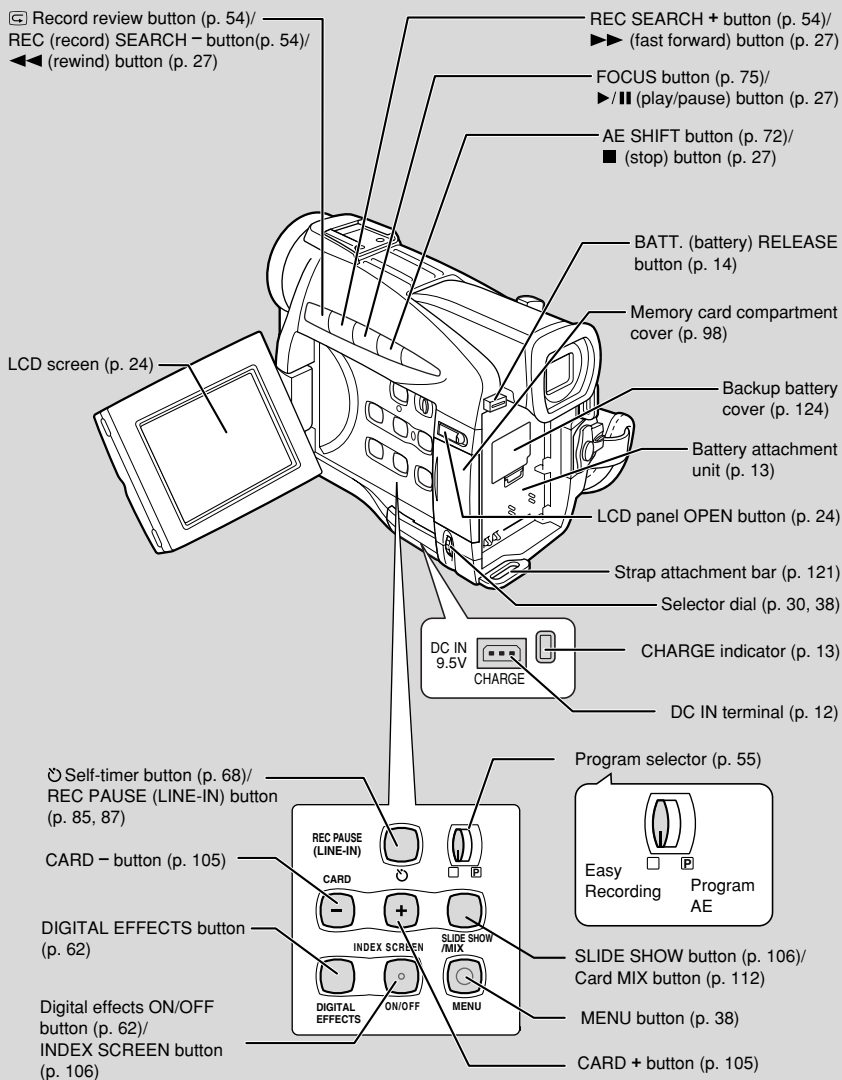

Mastering  
the Basics

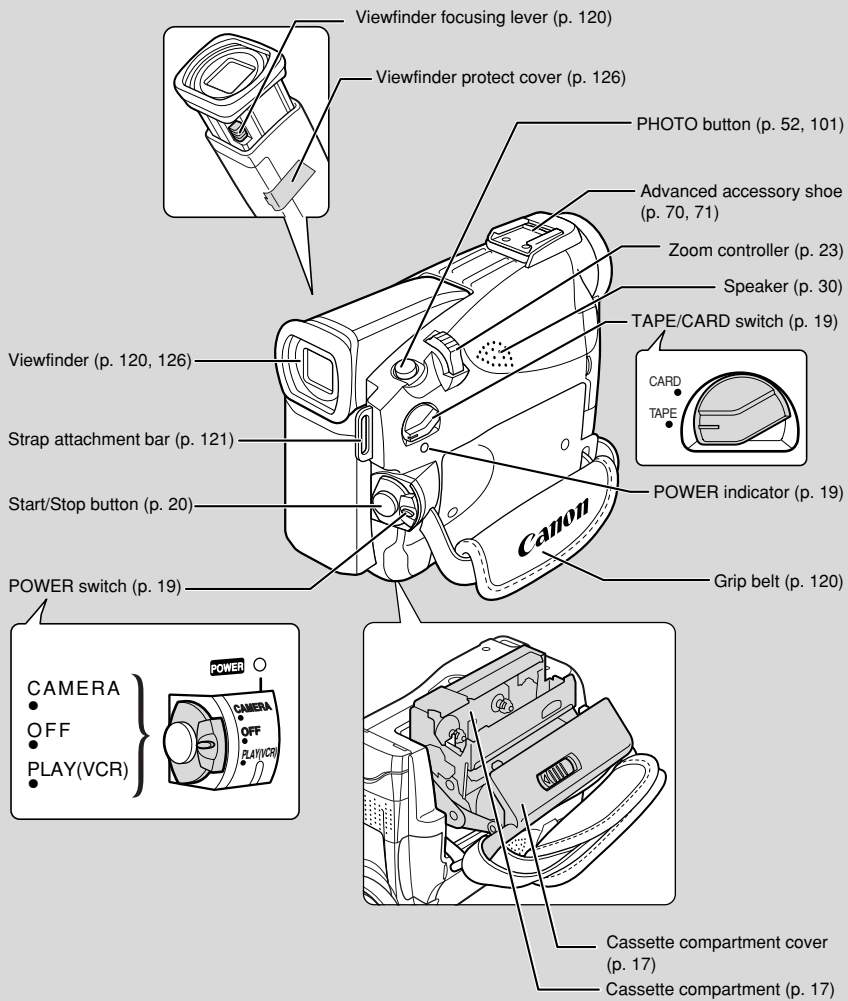

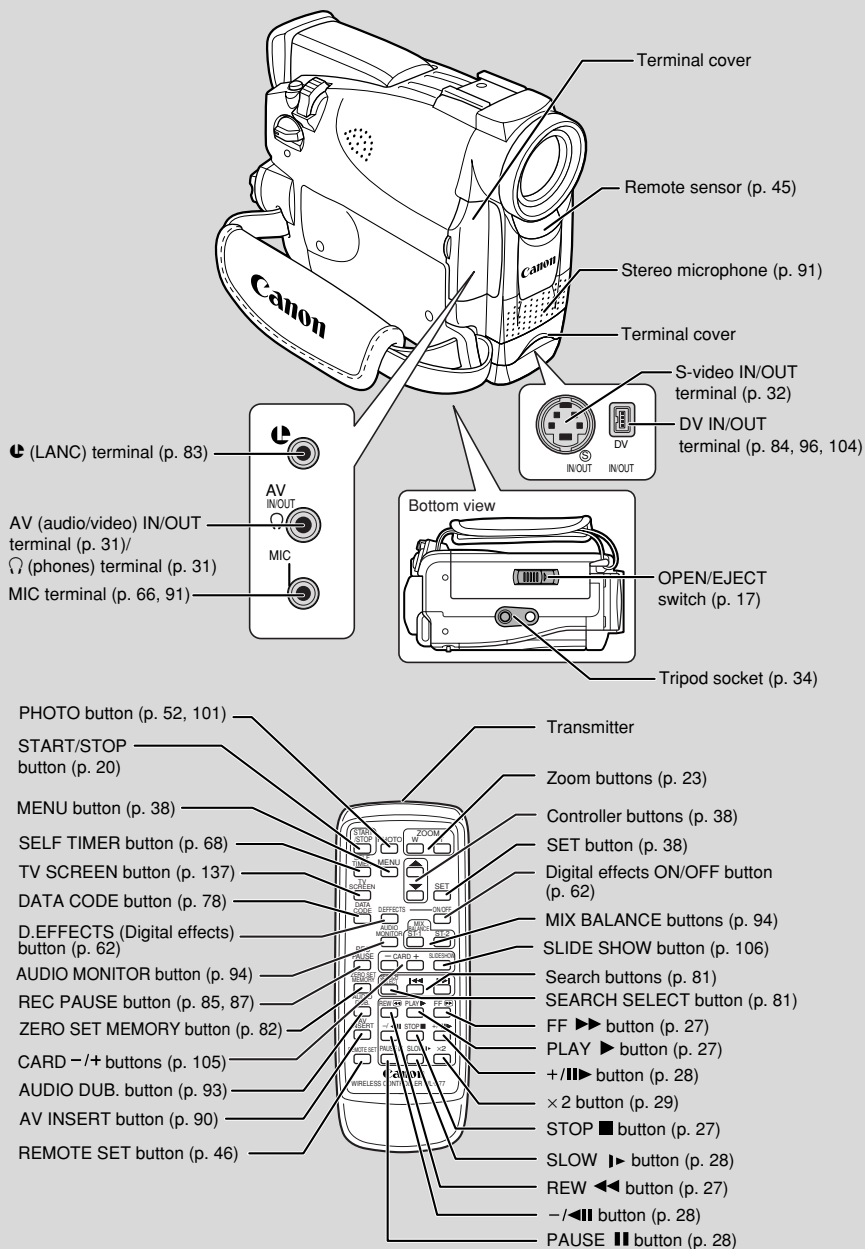

## Powering Your Camcorder

E

Before operating your camcorder, you will need to use the power adapter to:

**Provide power from an AC outlet**

or

**Charge a battery pack**

### **Notes:**

- The power adapter converts current from a household power socket (100–240 V AC, 50/60 Hz) to the DC current used by your camcorder.
- If the adapter is used next to a TV, it may cause bars to appear on the TV — move the adapter away from the TV or the antenna cable.

### Connecting the camcorder to an AC outlet

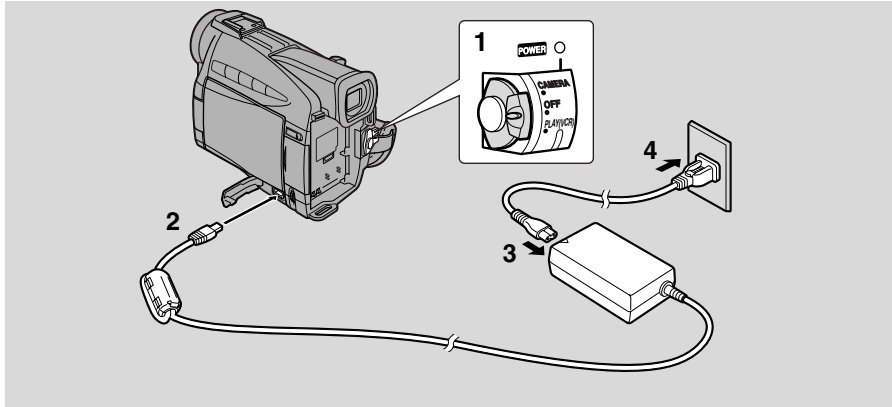

Use the power adapter to provide your camcorder with instant power from an AC outlet. Always turn the camcorder off before connecting/removing the power source.

1. Set the **POWER** switch to **OFF**.
2. Connect the power adapter to the camcorder's **DC IN** terminal.
3. Connect the power cable to the power adapter.
4. Plug the power cable into an **AC** outlet.
5. Disconnect the power adapter from the camcorder after use.  
Unplug the power cable from the AC outlet, then disconnect it from the adapter.

## Attaching and charging the battery packs

E

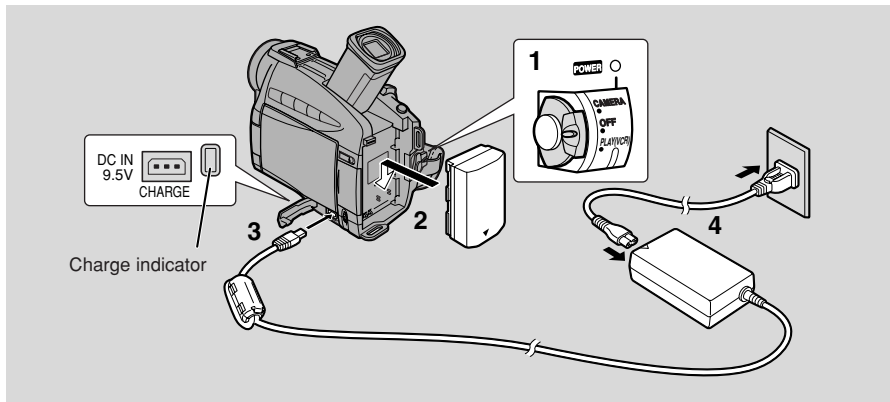

Your battery pack was partially charged before it left the factory. It should have enough power for you to check that your camcorder is working properly. However, you must charge the battery pack fully if you want it to power the camcorder for more than a few minutes.

Always turn the camcorder off and raise the viewfinder before connecting/removing the battery.

- 1. Set the POWER switch to OFF.**
- 2. Attach the battery to the camcorder.**
  - Remove the battery pack's terminal cover.
  - Rotate the viewfinder upwards.
  - With the triangle on the battery pack pointing downwards, align the edge of the battery pack with the line on the camcorder, press lightly and slide the battery down until it clicks into place.
- 3. Connect the power adapter to the camcorder.**
- 4. Connect the power cable to the adapter and plug it into an AC outlet.**
  - The charge indicator flashes red to show that charging is in progress. Single flashes mean that the battery pack is less than 75% charged. Double flashes mean that it is more than 75% charged. The indicator glows steadily when the battery pack is fully charged. If the indicator blinks rapidly and continuously (twice a second), the battery pack may be defective.
  - The battery pack will also charge when the POWER switch is turned to positions other than OFF. The CHARGE indicator may both flash or stay lit.

5. When charging is complete, disconnect the power adapter from the camcorder. Unplug the power cable from the AC outlet, then disconnect it from the adapter.
6. Remove the battery pack after use.
  - Rotate the viewfinder upwards.
  - Press and hold the BATT. RELEASE button while you slide the battery up.

**Notes:**

- Never connect an unspecified product to the camcorder's DC terminal. Likewise, do not connect the power adapter to an unspecified product.
- You can find detailed notes for using the batteries in the “Notes on Using the Batteries” (  122). These notes include charging and recording times and how to install the backup battery.

### CA-560 Compact Power Adapter

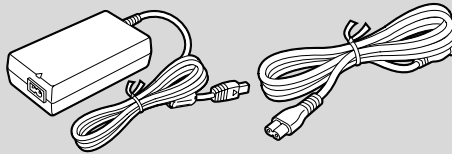

#### Specifications

<b>Power supply</b>	100–240 V AC, 50/60 Hz
<b>Power consumption</b>	34 W
<b>Rated output</b>	9.5 V, 2.7 A DC
<b>Operating temperature range</b>	32°F–104°F (0°C–40°C)
<b>Dimensions</b>	2 1/4 × 1 1/8 × 4 1/8 in (57 × 28 × 104 mm)
<b>Weight</b>	6 3/8 oz (180 g) (without power cable)

Weight and dimensions are approximate.

Errors and omissions excepted.

Subject to change without notice.

When replacement of power supply is required, please return it to the responsible nearest Canon Service Center and please replace it with the same type number CA-560 or equivalent.

The Adapter can be used with a power supply between 100 and 240 V AC. For areas where 120 V AC power is not used, you will need a special plug adapter. Contact your nearest Canon Service Center for further information.

### Using the Charge Adapter CR-560 Kit (optional)

The Compact Power Adapter CA-560 included with the camcorder can be used along with the CR-560 Kit for 3 different ways to power the camcorder or charge battery packs:

1. Charge the BP-500 Series battery packs with power from your car battery.
2. Operate the camcorder with power from your car battery.
3. Charge the BP-500 Series battery packs from a household AC outlet.

The Charge Adapter/Car Battery Cable Kit CR-560 includes the following:

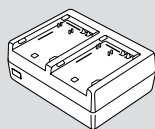

Charge Adapter

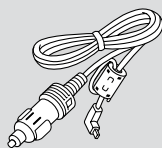

Car Battery Cable

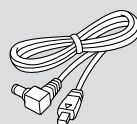

DC Cable

#### 1. Charge the BP-500 Series battery packs with power from your car battery.

1 or 2 battery pack(s) + Charge Adapter + Car Battery Cable → car's cigarette lighter

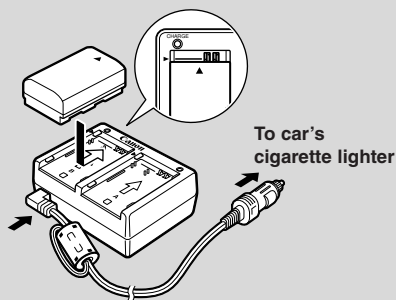

- Fast charging for the high-capacity BP-522 and BP-535 (both optional). Fifteen minutes of charging gives 60 minutes of recording (using the viewfinder).

	Time required for full charge from car battery or household outlet
BP-512	1 hr. 20 min.
BP-511 (optional)	1 hr. 20 min.
BP-522 (optional)	1 hr. 40 min.
BP-535 (optional)	2 hr. 30 min.

**E****2. Operate the camcorder with power from your car battery.**

Camcorder + DC Cable + Charge Adapter + Car Battery Cable → car's cigarette lighter

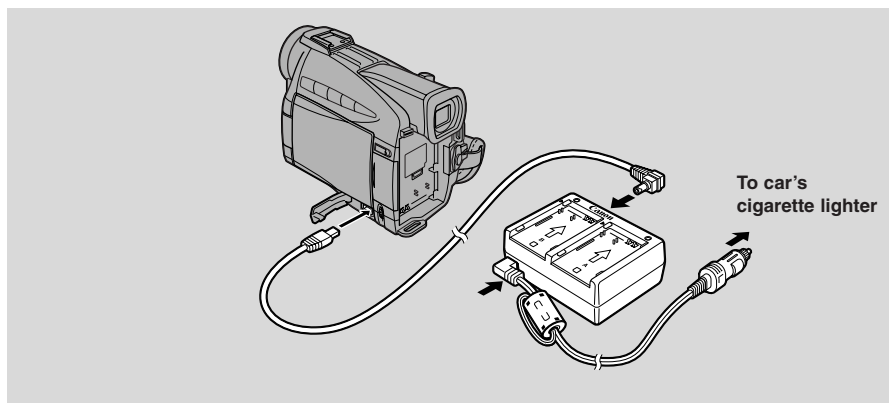
**Mastering  
the Basics****3. Charge the BP-500 Series battery packs from a household AC outlet.**

1 or 2 battery pack(s) + Charge Adapter + Compact Power Adapter

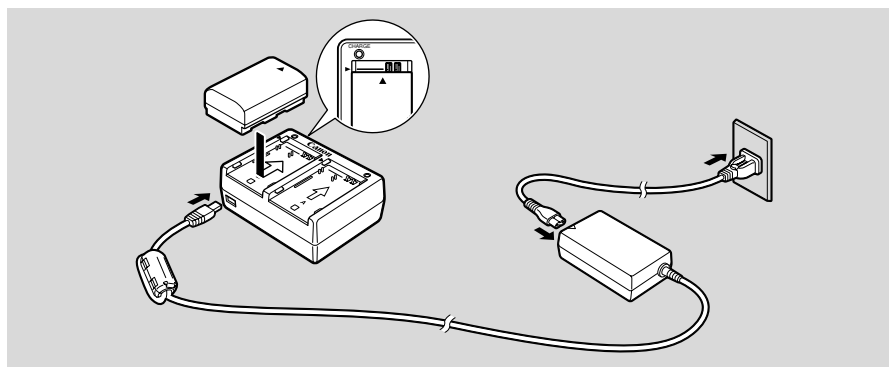

- Fast charging for the high-capacity BP-522 and BP-535 (both optional). Fifteen minutes of charging gives 60 minutes of recording (using the viewfinder).

**Note:**

- For full details of how to use the CR-560, refer to its instruction manual.



## Loading a Cassette

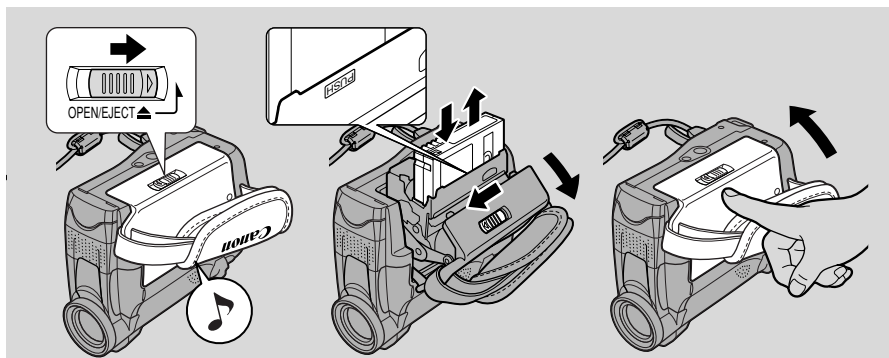



Only use videocassettes marked with the <sup>Mini</sup> DV logo.\*

### Loading and unloading

1. Make sure that you have attached a power source.
2. Slide the **OPEN / EJECT** ▲ switch (on the bottom of the camcorder) to release the cassette compartment cover.
  - Pull the cover fully open (while holding the button) and wait a couple of seconds for the cassette compartment to open automatically.
  - The confirmation beep sounds when the cassette cover fully opens.
3. Load or unload the cassette.
  - Insert the cassette gently with the window facing the grip belt, and the REC/SAVE tab up.
  - Remove the cassette by pulling it straight out.
4. Press the **[PUSH]** mark on the compartment until it clicks, and wait for it to close.
5. Click the cover back into place.

\* <sup>Mini</sup> DV is a trade mark.

#### Notes:

- Do not interfere with the cassette compartment while it is opening or closing automatically, and do not attempt to close the cover until the cassette compartment has fully retracted.
- After loading a cassette, use record search (  54) to find the point where you want to start recording.
- Be careful not to get your fingers caught in the cassette compartment cover.
- Do not leave the cassette in the camcorder after use — return it to its case and store it in a cool, clean, dry place.
- When you turn the camcorder's power on,  flashes in the display until you load a cassette.
- With some types of tapes, the remaining tape display may not give an accurate reading (  138).

## Protecting tapes from accidental erasure

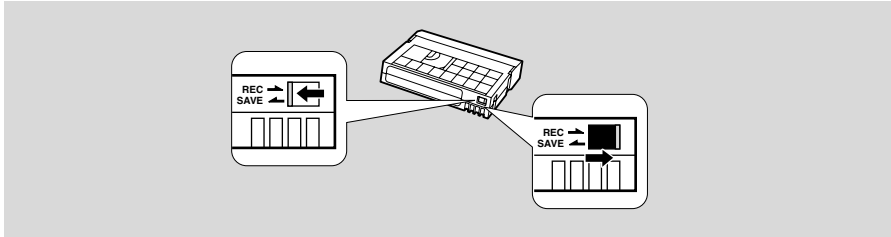

To protect your recording from accidental erasure, slide the tab on the cassette so that it exposes the hole. (This switch position is usually labeled SAVE or ERASE OFF.)

If you load this cassette and put the camcorder in record pause mode ( 19), “THE TAPE IS SET FOR ERASURE PREVENTION” is displayed for approx. 4 seconds and then the  mark flashes in the display.

If you want to record on the cassette again, slide the tab back so the hole is closed.

## Handling cassettes

- To protect the tape heads, transfer cassettes directly from the tape case to the camcorder — do not open the tape protect cover or touch the tape itself.
- Do not use cassettes where the tape has been damaged or spliced — they may damage the camcorder.
- Do not insert anything into the small holes on the cassette or cover them with cellophane tape.
- Handle cassettes with care — dropping them or exposing them to external shocks may cause internal damage.
- Store cassettes in the provided case, first rewinding them to the start of the tape and then storing them upright.
- A cassette with metal plated terminals may become dirty with use, affecting information transfer. Therefore, after using a tape about 10 times, be sure to clean the terminals with a cotton swab.

## Cassette memory

You are unable to use the cassette memory function with this camcorder.

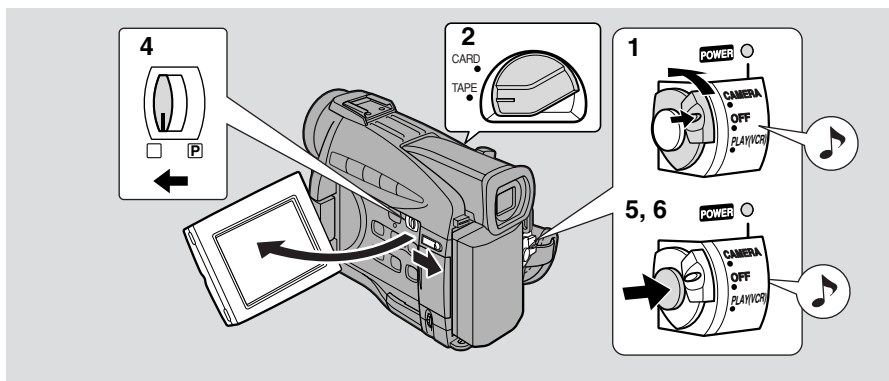

## Before you start recording

Have you completed the following steps?

- Attached a power source ( 12).
- Removed the lens cap ( 120) and fastened the shoulder strap ( 121).
- Chosen the display: viewfinder ( 120) or LCD screen ( 24)



### Notes:

- When you're using the viewfinder, fully close the LCD or rotate the LCD so that it faces the same direction as the lens ( 24).
- When using the viewfinder with the BP-522 or BP-535 Battery Pack (both optional) attached, extend the viewfinder and rotate it to a comfortable angle.

You may also want to install the backup battery ( 124) in order to set the date and time display ( 49).

## To record

- 1. Press the small green button on the POWER switch and hold, turn the POWER switch to CAMERA.**
  - The camcorder automatically sets to record pause mode. PAUSE appears in the display.
  - If you haven't set the date and time display, SET THE TIME ZONE, DATE AND TIME appears in the display. For setting the time zone, see p. 49. For setting the date and time, see p. 51.
  - The camcorder power indicator lights up red.
  - The confirmation beep sounds.
  - The camcorder will turn itself off if you leave it in record pause mode for more than about 5 minutes. To return to record pause mode, turn the POWER dial to OFF and then back to CAMERA.
- 2. Make sure the TAPE/CARD switch is set to TAPE.**
  - For still image recording to a memory card, see p. 101.
- 3. Load a cassette ( 17).**

4. **Slide the program selector to .**
  - This selects the camcorder's Easy Recording program. It allows you to simply point and shoot without making any manual adjustments (  57).
5. **Press and release the start/stop button once to begin recording.**
  - For still image recording to a cassette, see p. 52.
6. **Press and release the start/stop button again to pause recording.**
  - The camcorder returns to record pause mode and PAUSE reappears in the display.
  - You can stop and restart recording as often as you like by pressing the start/stop button.

**Note:**

- After loading a cassette, start recording when the tape counter has stopped.

### When you have finished recording

- Replace the lens cap.
- Return the viewfinder to its retracted position.
- Return the LCD screen flush to the camcorder body.
- Unload the cassette.
- Turn the POWER switch to OFF.
- Disconnect the power source.

**Notes:**

- To check that the camcorder is recording correctly, make a test recording first.
- Before making important recordings, clean the video heads using a Canon DVM-CL Digital Video Head Cleaning Cassette or a commercially available digital video head cleaning cassette.
- To close the LCD panel, rotate it vertically until the screen faces you, then press the upper right corner until it clicks securely closed.
- You cannot monitor the sound from the speaker when recording.
- For tips on how to make better videos, see p. 34.
- For extra recording time, set REC MODE to any mode other than SP (  21).

## Changing the recording mode



E

Choose from 4 recording modes: SP (standard play), 1.5× SP, 2× SP or 3× SP.

- Only SP and LP modes are available when the camcorder is set to CARD PLAY (VCR) mode.

### Recording times (this example uses an 80-minute tape)

Standard recording	Extended recording		
SP	LP	Ⓜ SP	Ⓜ LP
80 min.	1.5× SP (120 min.)	2× SP (160 min.)	3× SP (240 min.)

In Ⓜ SP and Ⓜ LP modes, image data is compressed twice as much as in SP and LP modes when being recorded to a tape.

You can't add sound (audio dubbing) or images (AV insert) to a tape that has been recorded in a mode other than SP mode. If you plan to use either of these functions later, record in SP mode.

**TAPE** + **CAMERA** , **TAPE** + **PLAY (VCR)** , **CARD** + **PLAY (VCR)**

**MENU**  
( 37)



To change the recording mode, open the menu and select VCR SET UP. Then select REC MODE, set it to LP, Ⓜ SP or Ⓜ LP and close the menu.

### Notes:

#### About all 3 extended recording modes

- When recording and playing back tapes in one of the extended recording modes, the nature of the tape and usage conditions may affect recording, mosaic-like noise may appear in the image and the sound may be distorted during playback. For important recordings, therefore, set the camcorder to SP mode.
- If you record in more than one mode on the same tape, the picture may become distorted during playback and the time code may not be written correctly.
- A tape recorded in LP mode on other digital equipment may produce the mosaic-like noise and the sound may become distorted when playing back on this camcorder.
- A tape recorded in LP or Ⓜ LP mode on this camcorder may produce the mosaic-like noise and the sound may become distorted when playing back on other digital equipment.

#### About Ⓜ SP and Ⓜ LP modes

- The image quality of recordings done in Ⓜ SP or Ⓜ LP modes will be lower than that of those done in SP or LP modes.
- A cassette recorded in Ⓜ SP or Ⓜ LP mode cannot be played back on a camcorder not equipped with that mode.

- The recording mode might not appear in the display correctly if you switch between **SP** and **LP** while the camcorder is connected to another digital video device.
- When the recording mode is changed to **SP** or **LP**, the camcorder modifies the image for appropriate recording in that mode.
- You might not be able to do DV dubbing correctly with the camcorder set to **SP** or **LP** mode.

### 16:9 (Widescreen TV recording)



Produces images in the 16:9 format for playback on widescreen TVs.

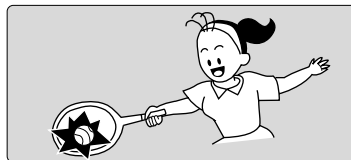

**TAPE** + **CAMERA**

#### MENU

( 37)

▶CAM.SET UP

▶16:9.....OFF

To switch 16:9 to ON, open the menu and select CAM.SET UP. Then select 16:9, set it to ON and close the menu.

#### Notes:

- “16:9” is shown in the display when you switch the 16:9 mode on.
- You cannot use the 16:9 mode with the Easy Recording program.
- You cannot use the 16:9 mode when the multi-image screen is set. The 16:9 display becomes set to “- - -”.
- If you play back a recording made for 16:9 on a normal TV screen, the image will appear to be vertically “squashed” (compressed).
- If you connect the camcorder to a TV with an S1 terminal or the Video ID-1 system, recordings made in the 16:9 mode for wide screen TVs will automatically play back in wide screen mode on the TV screen.

### Confirmation/Warning beeps



The camcorder’s short operation confirmation beeps are indicated by in the illustrations. Beeps sound upon certain camcorder operations such as when you turn the camcorder on, during the self-timer countdown, right before the camcorder’s automatic shut-off, and also upon any unusual condition of the camcorder. Beeps are not recorded on the tape.

**TAPE** + **CAMERA** , **TAPE** + **PLAY (VCR)** , **CARD** + **CAMERA** , **CARD** + **PLAY (VCR)**

#### MENU

( 37)

▶SYSTEM

▶BEEP.....ON

To turn the beep off, open the menu and select SYSTEM. Then select BEEP, set it to OFF and close the menu.

# Zooming

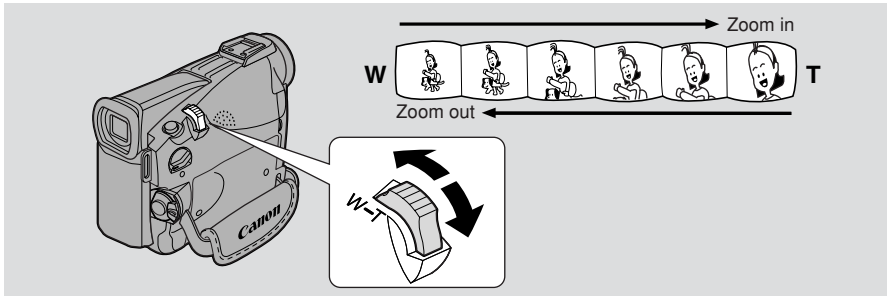

E

## 10× optical zoom

The camcorder's 10× zoom lens allows you to choose the best picture angle for each scene:

- Move the zoom control towards W to zoom out to wide-angle.
- Move it towards T to zoom in to telephoto.

You can also control the speed of zooming:

- Move the control slightly to zoom slowly.
- Move it farther to zoom more quickly. (The farther you move the zoom control, the faster the zoom speed.)

The T and W buttons on the wireless controller adjust the picture angle, but not the zoom speed.

## 200× digital zoom

Card 40×

Magnifies the camcorder's zoom range by up to 20× (up to 4× when using a memory card).

The zoom control continues to work as usual. You can freely zoom in and out between 1× and 200× magnification — the camcorder automatically switches between optical zooming (up to 10×) and digital zooming (10× to 200×).



**MENU**

( 37)

▶CAM.SET UP

▶D.ZOOM.....40×

**To change the digital zoom, open the menu and select CAM.SET UP. Then select D.ZOOM, set it to OFF or 200× and close the menu.**

### Notes:

- When zooming, as a rule, keep at least 3 ft 3<sup>3</sup>/<sub>8</sub> in (1 m) between you and your subject. However when the zoom is at the wide-angle position, you can focus on a subject as close as <sup>3</sup>/<sub>8</sub> in (1 cm).
- Image resolution is slightly lower when the magnification is greater than 10×.
- You cannot use digital zoom when the multi-image screen is set. The display becomes “— —”.
- The zoom indicator appears for 4 seconds. When the digital zoom is set to 40×, the zoom indicator extends (light blue).  
When the digital zoom is set to 200× zoom, the zoom indicator extends again (a darker blue).

## Using the LCD Screen

E

### Opening and closing the LCD screen

Slide the LCD panel OPEN button and open the panel by pulling it away from the camcorder. This automatically switches the LCD screen on and the viewfinder off. When you close the LCD panel, press the upper corner until it clicks closed. The LCD screen automatically switches off and the viewfinder switches back on.

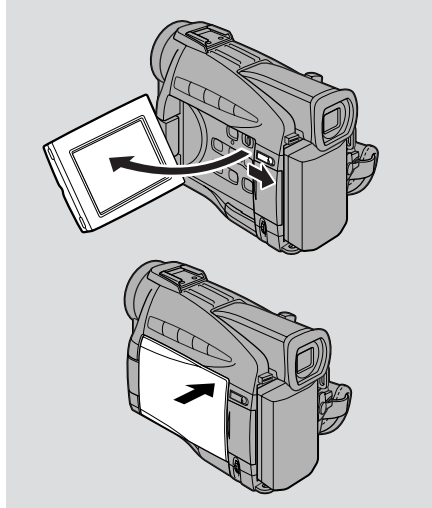

### Changing the angle of the LCD screen

You can choose the angle of the screen that suits you best by opening and rotating the screen, also you can rotate the LCD screen so that faces in the direction of the lens ( 26).

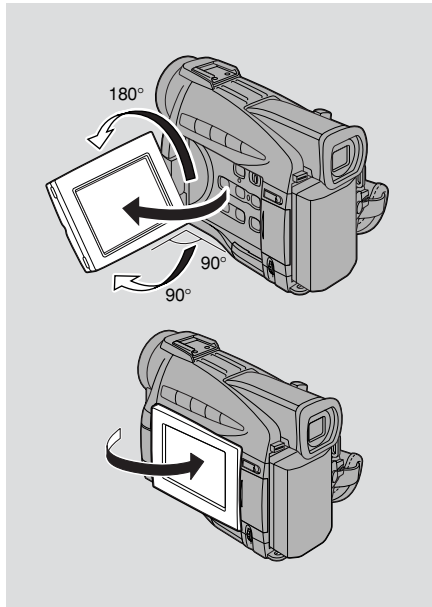

You can also push the panel flat against the camcorder until it is flush with the side, with the screen facing outwards.



**Notes:**

- Avoid touching the LCD screen when moving the LCD panel.
- Do not hold the camcorder by the LCD panel or the viewfinder.
- Make sure you open the LCD panel at 90°, before attempting to rotate it.
- Always rotate the LCD panel vertically into place, before closing it or pushing it flat against the side of the camcorder.
- Always fully close the LCD panel until it clicks securely.
- Be careful not to leave the LCD, viewfinder or lens exposed to direct sunlight outdoors or in a window. Doing so could cause damage.
- Bright light falling on the LCD screen may cause glare that makes it difficult for you to view the image. In this case, switch to using the viewfinder. You are also able to adjust the brightness of the screen (see “Adjusting the LCD screen” below).

**Adjusting the LCD screen**

You can adjust the brightness of the LCD screen.



Open the menu and select **DISP.SET UP** from the menu. Then select **BRIGHTNESS**, adjust the level with the selector dial and close the menu.

A bar showing the level appears in the display.

- Turn the selector dial up to make the display brighter.
- Turn the selector dial down to make the display darker.

**Notes:**

- The camcorder will remember your brightness setting even after you turn it off.
- The brightness of the LCD does not affect that of the recorded images or the viewfinder.

**About the LCD Screen**

The LCD screen built into this camcorder is a high precision product. However, small black dots or bright points of light (red, blue or green) may appear constantly on the LCD screen. This is not a malfunction of the LCD screen and they are not recorded on the tape. (Effective dots: more than 99.99%)

## Allowing the subject to monitor recording



When you turn the LCD panel so that it faces the same direction as the lens, you can watch yourself during recording or let your subject monitor recording. The viewfinder is also activated when the panel is in this position. (Adjusting the viewfinder, [120](#))

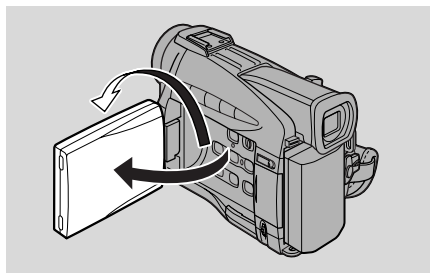

- You can choose the display style, reversed (mirror on) or not (mirror off). The recording itself is unaffected regardless of which one you choose.

**TAPE** + **CAMERA** , **CARD** + **CAMERA**

### MENU

([37](#))



To turn the mirror mode off, open the menu and select **DISP.SET UP**. Then select **MIRROR**, set it to **OFF** and close the menu.

The indicators that appear in the LCD display when **MIRROR** is turned on:

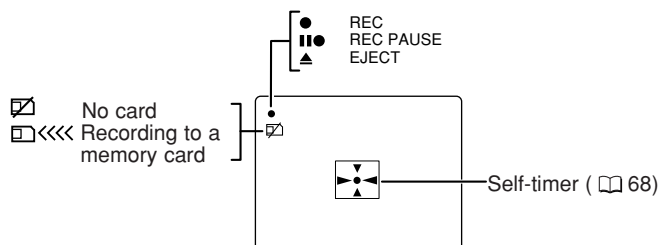

- These and all other indicators appear normally in the viewfinder.

## Playing Back a Cassette

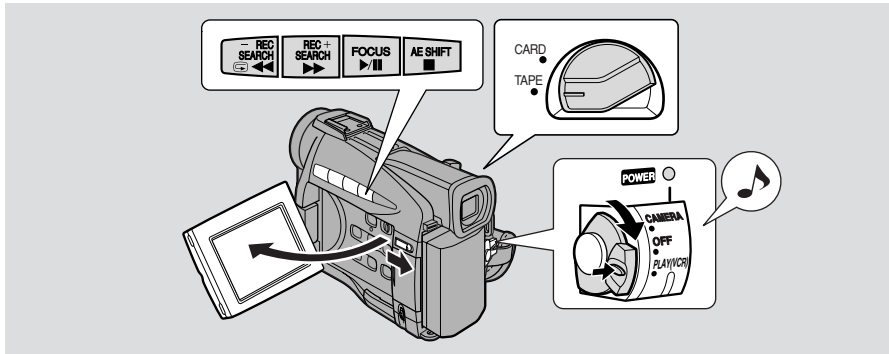

E

You can use the LCD screen for instant, on-the-spot playback. The camcorder also plays back the sound track via the built-in speaker ( 30).

- When you play back a tape, you can also close the LCD panel with its screen side facing up.
- When you're using the viewfinder to view playback, close the LCD panel.

To play back your recordings on a TV, see p. 31.

To use the wireless controller, see p. 45.

### **Note:**

- To avoid accidental recording, make sure that you slide the tab on the cassette so that it exposes the hole (the switch position is usually labeled SAVE or ERASE OFF).

### **1. Attach a power source and turn the POWER switch to PLAY (VCR).**

- The power indicator lights up green.

### **2. Make sure the TAPE/CARD switch is set to TAPE.**

### **3. Load the cassette.**

### **4. Press the ► (play) button to start playback.**

- To end playback, press the ■ (stop) button.
- To wind the tape forwards, stop playback and press the ►► (fast forward) button.
- To wind the tape backwards, stop playback and press the ◀◀ (rewind) button.
- If the playback picture is rough (mosaic-like noise), clean the video heads using a Canon DVM-CL Digital Video Head Cleaning Cassette or a commercially available digital video head cleaning cassette.

## Other playback modes



### Playback pause

Press the **||** (pause) button. To resume normal playback, press it again, or press the **▶** (play) button. The camcorder automatically goes into stop mode after about 5 minutes' playback pause.

### Fast forward playback

To play back the recording at about 9.5 times normal speed, press and hold the **▶▶** (fast forward) button during normal playback or press and hold the **▶▶** (fast forward) button during normal fast forward.

### Rewind playback

For reverse playback at about 9.5 times normal speed, press and hold the **◀◀** (rewind) button during normal playback or press and hold the **◀◀** (rewind) button during normal rewind.

## Special playback



### Frame Advance

To play back frame by frame, press the **+ / ▶▶** button repeatedly during playback pause. Press and hold to play back continuous frame advance.

### Frame Reverse

To play back in reverse frame by frame, press the **- / ◀◀** button repeatedly during playback pause. Press and hold to play back continuous frame reverse.

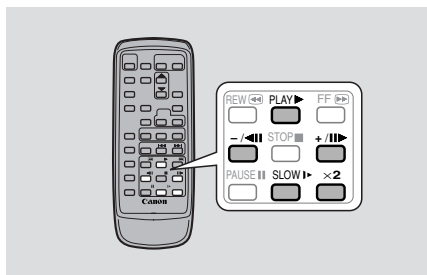

### Slow Forward Playback

To play back at about 1/5 normal speed, press the **SLOW ▶** button during normal playback.

Press the **PLAY ▶** button to return to normal playback.

- The camcorder automatically returns to playback after about 30 seconds of slow playback.

### Slow Reverse Playback

To play back in reverse at about 1/5 normal speed, press the  $-\text{<|||}$  button and then the SLOW  $\text{▶}$  button during normal playback.

Press the PLAY  $\text{▶}$  button to return to normal playback.

- The camcorder automatically returns to  $\times 1$  reverse playback after about 30 seconds of slow playback.

### Reverse Playback

To play back in reverse at normal speed, press the  $-\text{<|||}$  button during normal forward playback.

Press the PLAY  $\text{▶}$  button to return to normal forward playback.

- The camcorder automatically goes into stop mode after about 2 minutes of paused reverse playback.

### Forward $\times 2$ Playback

Press the  $\times 2$  button during normal playback.

Press the PLAY  $\text{▶}$  button to return to normal playback.

### Reverse $\times 2$ Playback

Press the  $-\text{<|||}$  button and then the  $\times 2$  button during normal playback.

Press the PLAY  $\text{▶}$  button to return to normal playback.



#### Notes:

- Mosaic-like noise appears on the screen during some of the special playback modes.
- There's no audio during special playback.

## Built-in speaker



The camcorder has a built-in speaker so you can review the sound track alongside the picture during tape playback. The built-in speaker is monaural.

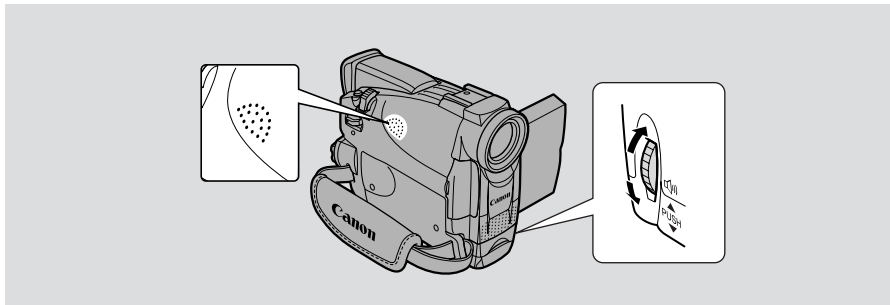

Adjust the speaker volume by turning the selector dial.

- Turn the selector dial up to increase the volume, and down to lower the volume.
- A bar appears in the display to indicate the current volume. It disappears in 4 seconds.
- You can turn off the volume completely by turning the selector dial down until OFF appears.



### Notes:

- Sometimes audio may sound distorted when the volume is turned up high. If this happens, turn down the volume.
- The speaker turns off when the camcorder is set to any mode other than TAPE PLAY (VCR) mode.

### Using the headphones

- You can also use the headphones to monitor the sound track. Change the setting of the AV/headphones terminal through the menu ( 31).
- You can adjust the headphone volume separately from the built-in speaker, either during TAPE PLAY (VCR) mode or TAPE CAMERA mode. The volume level is the same regardless of mode.
- The levels you adjust for the built-in speaker and headphones are memorized separately. The camcorder remembers your levels even if you turn the camcorder off and back on again.
- The speaker turns off when you use headphones.

## Connections for Playback on a TV Screen

You can connect the camcorder to a TV or VCR in order to play back your recordings. You will need to attach a power source to the camcorder ( 12). Power off all devices before starting the connections.

E

See your TV or VCR instruction manual for further details.

### Switching the AV/headphone terminal

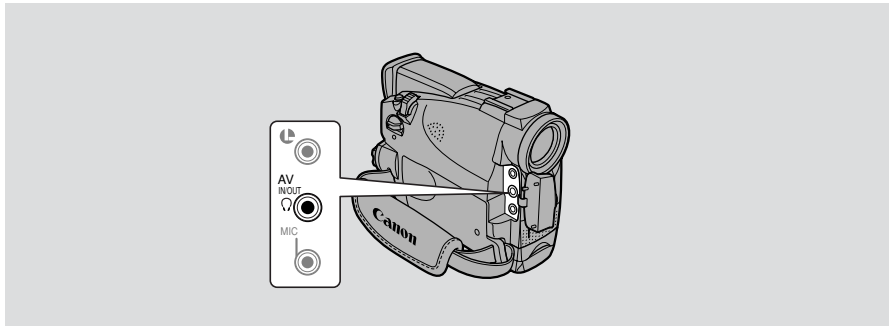

Through the menu, the camcorder's AV/headphone terminal can be switched to function as either the AV terminal or the headphone terminal.

**TAPE** + **CAMERA** , **TAPE** + **PLAY (VCR)** , **CARD** + **CAMERA** , **CARD** + **PLAY (VCR)**

**MENU**  
( 37)

▶ VCR SET UP

▶ AV/PHONES...AV

Open the menu and select **VCR SET UP**. Then select **AV/PHONES** and set it to **AV** or **PHONES**.

- When the terminal is switched to **PHONES**, **PHONES** appears in the display.

#### Using the headphones

- Make sure you switch the AV/headphones terminal to **PHONES** before using headphones. If the AV/headphones terminal is not switched to **PHONES** before you use the headphones, noise will come out from the headphones.

**E****If your TV (or VCR) has an S (S1) -video input terminal**

For higher picture quality, we recommend playing back recordings on a TV with an S (S1) terminal. If you connect the camcorder to a TV with an S1 terminal, recordings made in the 16:9 mode for wide screen TVs will automatically play back in wide screen mode on the TV screen.

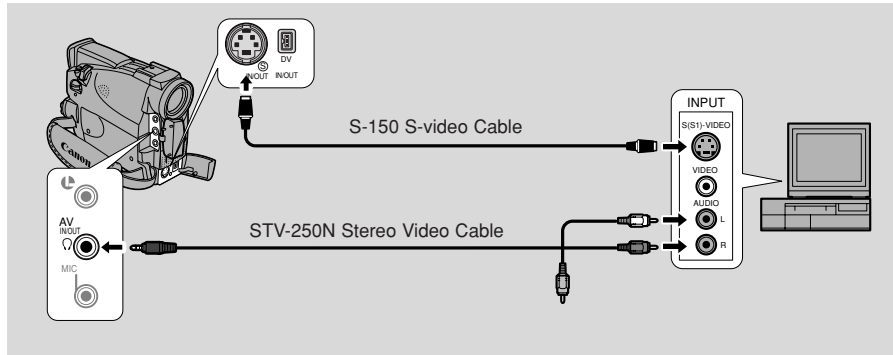
**Mastering  
the Basics**

When connecting for playback on a TV screen, make sure the AV/headphone terminal is switched to AV. If PHONES appears in the display, switch the terminal.

- Use the S-150 S-video Cable to connect the S-video terminals. Use the STV-250N Stereo Video Cable to connect the AUDIO terminals. Connect the white plug to the white AUDIO terminal **L** (left). Connect the red plug to the red AUDIO terminal **R** (right). Do not connect the yellow plug.
- If you are connecting the camcorder to a TV, set the TV/VIDEO selector on the television to VIDEO.
- If you are connecting the camcorder to a VCR, set the input selector on the VCR to LINE.



## If your TV (or VCR) has audio/video input terminals

E

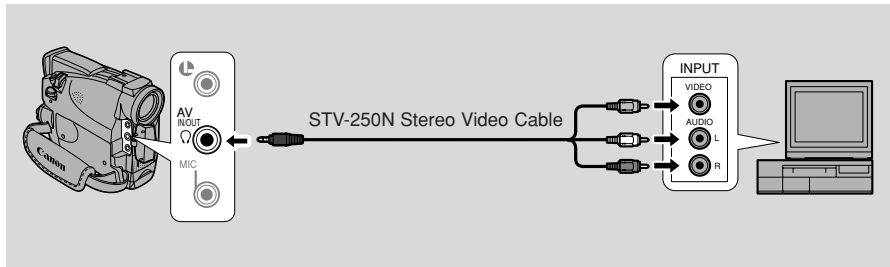

When connecting for playback on a TV screen, make sure the AV/headphone terminal is switched to AV. If PHONES appears in the display, switch the terminal.

- Connect the camcorder using the STV-250N Stereo Video Cable. Connect the white plug to the white audio terminal **L** (left). Connect the red plug to the red audio terminal **R** (right). Connect the yellow plug to the yellow video terminal **VIDEO**.
- If you are connecting the camcorder to a TV, set the TV/VIDEO selector on the television to VIDEO.
- If you are connecting the camcorder to a VCR, set the input selector on the VCR to LINE.

### Notes:

- If you are going to use the TV as a monitor while you are shooting, remember to keep the TV volume turned down as long as the camcorder's audio terminals are connected. If the sound from the TV speakers is picked up by the microphone, an unpleasant high-pitched squeal, called feedback, may be produced.
- For TVs having the Video ID-1 system:  
If you connect the camera to the TV's S terminal or video in terminal, recordings made in the 16:9 mode for wide screen TVs will automatically play back in wide screen mode on the TV screen.

## Tips for Making Better Videos

E

### Holding the camcorder

For maximum stability, grip the camcorder in your right hand and keep your right elbow pressed against your body. If necessary support the camcorder with your left hand. With practice, you will be able to operate the controls by touch, without taking your eye off the action.



### Using a tripod

To prevent any unwanted movement, you can mount the camcorder on a tripod, (or any flat surface at a suitable height) and operate it with the wireless controller.

- When you are using a tripod, be careful not to leave the viewfinder exposed to bright sunlight or it will melt. (The light is concentrated by the viewfinder lens.)
- Make sure that the fastening screw of the tripod is no longer than  $\frac{1}{4}$  inch (5.5 mm), or it will damage the camcorder.



### Composition

The most important element in the scene does not have to be in the center. For a more interesting picture, try to position your subject so it is slightly to one side. Leave some space on the side of the frame that the subject is facing or moving towards.

Don't cut off the top of the subject's head, and don't cut people off at the neck, hips or knees (move a little bit above or below).

Watch out for distracting objects in the background.

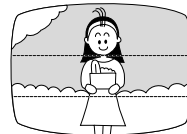

## Picture angle

Instead of zooming while recording, try to choose your picture angle before you begin. A good way to tell a story with video is to begin with a long shot that establishes the situation, and then move in with medium shots and close-ups to show the details. Remember to change your viewpoint for each shot.

Remember that any camcorder movement or change in picture angle should have a definite purpose. Avoid unnecessary or half-hearted movements.



Long shot



Medium shot



Close-up

## Camcorder moves

Use pans to record a landscape or follow a moving subject. Decide the area you want to cover and stand facing the end of your panning angle. Without moving your feet, turn your waist to the starting position. Start recording, and after a few seconds begin to turn slowly from the waist. Hold the final image for a few seconds before you stop recording.

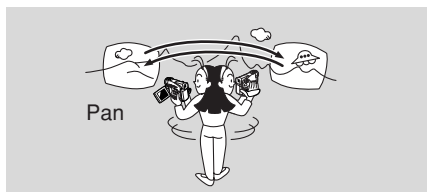

Pan

Tilt the camcorder up to exaggerate the height of the subject. Tilt down from the top of a building, for example, as an introduction to subjects at the bottom.



Tilt

## Turning the Image Stabilizer Off



E

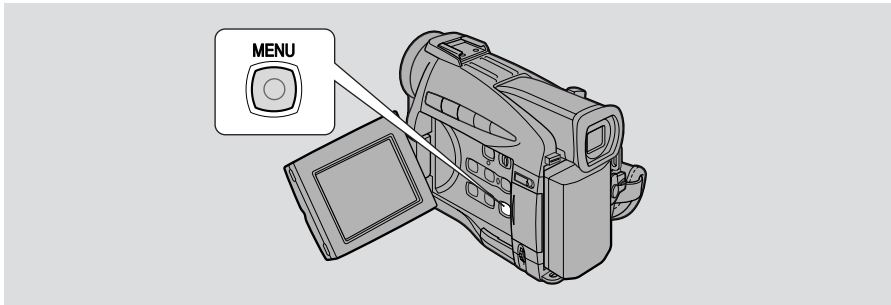

With most camcorders, even the slightest hand movements will be noticeable during telephoto recording. However, the ZR30 MC's image stabilizer allows you to obtain steady recordings even at high magnification.

**TAPE** + **CAMERA** , **CARD** + **CAMERA**

**MENU**  
( 37 )

▶CAM.SET UP

▶IMAGE S. ·ON

**To turn the image stabilizer off, open the menu and select CAM.SET UP. Then select IMAGE S. , set it to OFF and close the menu.**

- The mark disappears from the display when the stabilizer is off.
- The image stabilizer cannot be turned off when the program selector is set to the (Easy Recording) position.

### **Notes:**

- The image stabilizer is designed to deal with a normal degree of camcorder shake.
- Keep the image stabilizer turned off when the camcorder is mounted on a tripod.
- The image stabilizer is not as effective as usual during the Low Light mode.

# Using the Menu



Many of the camcorder's advanced functions are selected from menus which appear in the display.

E

There are 4 main menus:

- CAM. MENU    Camera menu                    ( 39)
- VCR MENU    VCR menu                                    ( 40)
- C.CAM. MENU Card camera menu            ( 42)
- C.PLAY MENU Card play menu                ( 43)

## ● CAM. MENU    TAPE + CAMERA

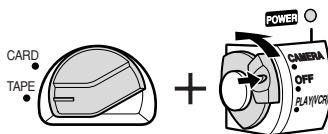
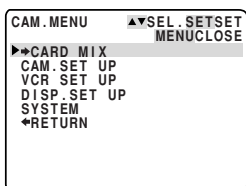

## ● VCR MENU    TAPE + PLAY (VCR)

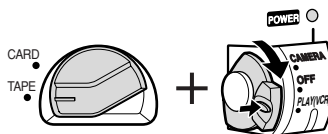
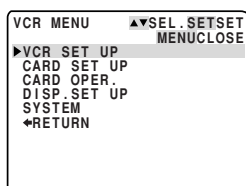

## ● C. CAM. MENU    CARD + CAMERA

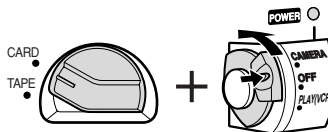
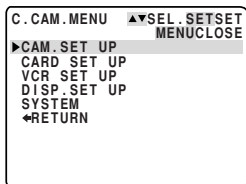

## ● C. PLAY MENU    CARD + PLAY (VCR)

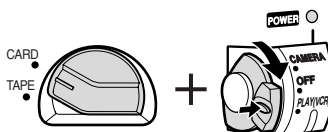
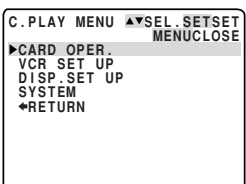

Using the Full  
Range of Features

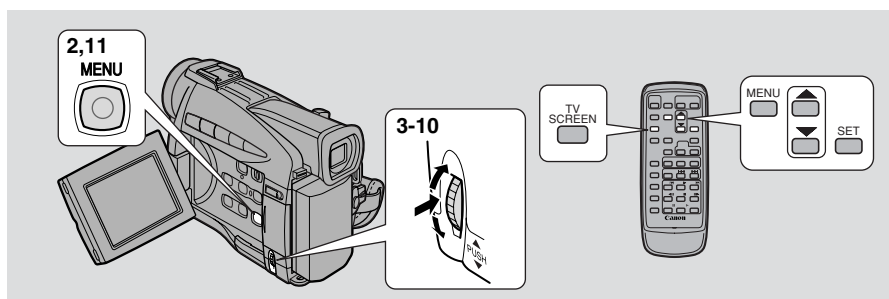

1. Turn the **POWER** switch and the **TAPE/CARD** switch to the desired settings.
2. Press the **MENU** button to open the menu.
  - One of the main menus appears, according to the settings of the TAPE/CARD switch and the POWER switch.
3. Turn the selector dial and move the arrow to the desired submenu.
4. Press the selector dial in to select.
  - The submenu appears.
5. Turn the selector dial and move the arrow to the desired function.
6. Press the selector dial in to select.
  - The function and its settings only appear.
7. Turn the selector dial and move the arrow to the desired setting.
  - If you are setting a function other than the white balance or shutter speed, the function will be set if you skip to step 11.
8. Press the selector dial in to select.
  - The function is set and you return to the submenu.
9. Turn the selector dial and move the arrow to **← RETURN**.
10. Press the selector dial in to select.
  - You return to the main menu.
11. Press the **MENU** button.
  - The main menu disappears.

**Notes:**

- Pressing the **MENU** button at any time closes the menu.
- Selecting **← RETURN** takes you back one menu, or closes the main menu.
- Items that are unavailable, due to the tape or card situation or the settings of other menu items, appear in purple.
- You may often find it convenient to use the wireless controller to move around the menus. Press its **MENU** button to open/close the menu and use the arrow keys in place of turning the selector dial. Push the **SET** button to select.



- Pressing the start/stop button or the PHOTO button will close the menu and start recording.
- You can display the menus on a connected TV screen by turning TV SCREEN (📖 137) on through the menu or using the wireless controller's TV SCREEN button. See p. 31 for TV hookup instructions.

## List of Menus

Turn to the appropriate page for a detailed explanation of each function.

### ● CAM. MENU

Set the POWER switch to **CAMERA** and the TAPE/CARD switch to **TAPE**.  
There are 5 submenus within the CAM. MENU.

- ① To card mix submenu
- ② To camera set up submenu
- ③ To VCR set up submenu
- ④ To display set up submenu
- ⑤ To system submenu
- ⑥ Close main menu

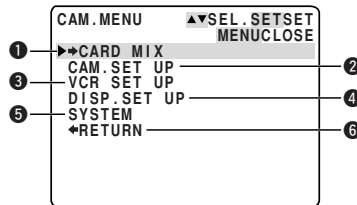

#### ① Card mix submenu

- ① Mix type..... 📖 111
- ② Mix level..... 📖 112

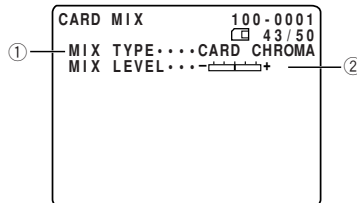

#### ② Camera set up submenu

- ③ Shutter speed..... 📖 73
- ④ Digital zoom ..... 📖 23
- ⑤ Image stabilizer..... 📖 36
- ⑥ 16:9 effect..... 📖 22
- ⑦ White balance ..... 📖 76
- ⑧ Return

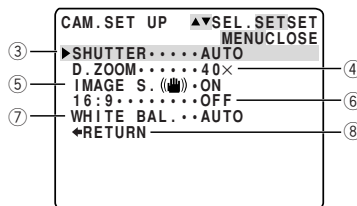

Using the Full Range of Features

**E**

**CAM. MENU, cont.**

**3 VCR set up submenu**

- 9 Record mode..... 21
- 10 Wind screen ..... 67
- 11 Audio mode ..... 66
- 12 AV or headphones..... 31
- 13 Return

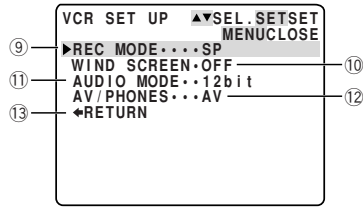

**4 Display set up submenu**

- 14 Brightness ..... 25
- 15 Mirror mode..... 26
- 16 TV screen..... 137
- 17 Date/time display ..... 51
- 18 Return

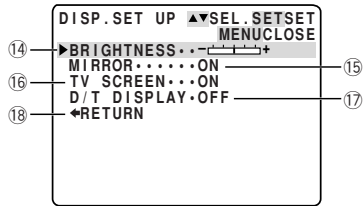

**5 System submenu**

- 19 Wireless controller..... 46
- 20 Light-up buttons ..... 48
- 21 Button light color..... 48
- 22 Beep ..... 22
- 23 Time zone/Daylight saving time..... 49
- 24 Date/time set..... 51
- 25 Return

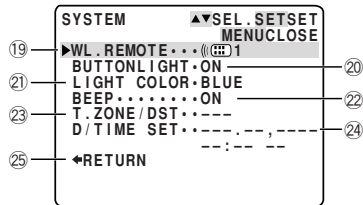

**● VCR MENU**

Set the POWER switch to **PLAY (VCR)** and the TAPE/CARD switch to **TAPE**. There are 5 submenus within the VCR MENU.

- 1 To VCR set up submenu
- 2 To card set up submenu
- 3 To card operations submenu
- 4 To display set up submenu
- 5 To system submenu
- 6 Close main menu

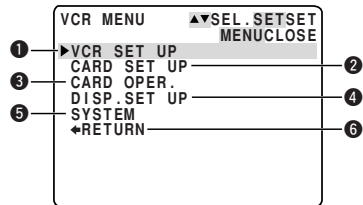

Using the Full Range of Features



## 1 VCR set up submenu

- ① Record mode..... 21
- ② Output channel..... 95
- ③ Audio dubbing ..... 92
- ④ Wind screen ..... 67
- ⑤ Audio mode ..... 66
- ⑥ AV or headphones..... 31
- ⑦ Return

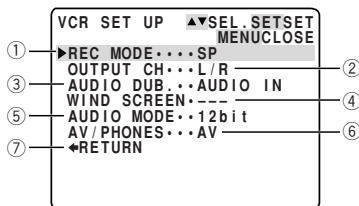

## 2 Card set up submenu

- ⑧ Image quality ..... 98
- ⑨ File numbers ..... 100
- ⑩ Return

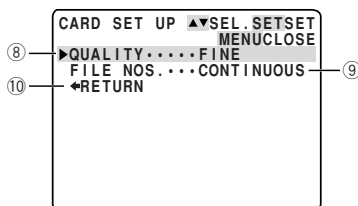

## 3 Card operations submenu

- ⑪ Copy from cassette to card. 113
- ⑫ Return

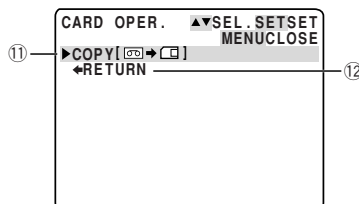

## 4 Display set up submenu

- ⑬ Brightness ..... 25
- ⑭ Displays ..... 137
- ⑮ 6-second auto date ..... 80
- ⑯ Data code ..... 79
- ⑰ Date/time select ..... 78
- ⑱ Return

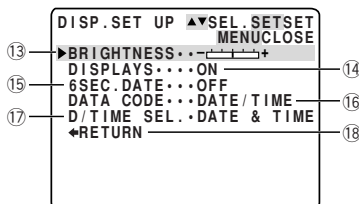

**E**

**VCR MENU, cont.**

**5 System submenu**

- 19 Wireless controller..... 46
- 20 Light-up buttons ..... 48
- 21 Button light color..... 48
- 22 Beep ..... 22
- 23 Return

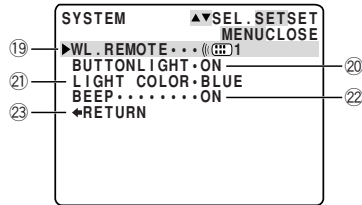

**C. CAM. MENU**

Set the POWER switch to **CAMERA** and the TAPE/CARD switch to **CARD**.

There are 5 submenus within the C. CAM. MENU.

- 1 To camera set up submenu
- 2 To card set up submenu
- 3 To VCR set up submenu
- 4 To display set up submenu
- 5 To system submenu
- 6 Close main menu

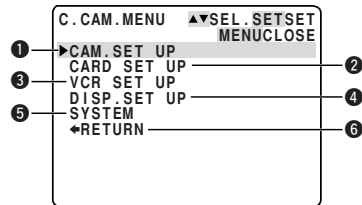

**1 Camera set up submenu**

- 1 Shutter speed..... 73
- 2 Digital zoom ..... 23
- 3 Image stabilizer..... 36
- 4 White balance ..... 76
- 5 Return

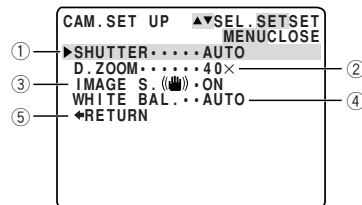

**2 Card set up submenu**

- 6 Image quality ..... 98
- 7 File numbers ..... 100
- 8 Return

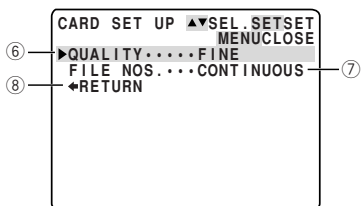

Using the Full Range of Features

### 3 VCR set up submenu

- 9 AV or headphones..... 31

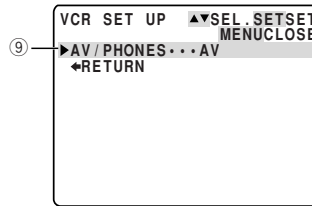

### 4 Display set up submenu

- 10 Brightness ..... 25  
 11 Mirror mode..... 26  
 12 TV screen..... 137  
 13 Date/time display ..... 51  
 14 Return

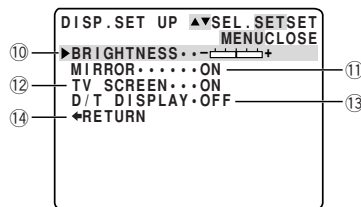

### 5 System submenu

- 15 Wireless controller..... 46  
 16 Light-up buttons ..... 48  
 17 Button light color..... 48  
 18 Beep ..... 22  
 19 Time zone/Daylight saving  
 time ..... 49  
 20 Date/time set ..... 51  
 21 Return

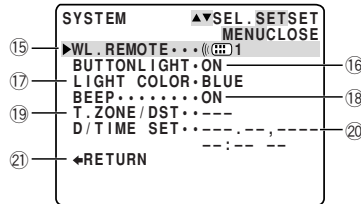

## ● C. PLAY MENU

Set the POWER switch to **PLAY (VCR)** and the TAPE/CARD switch to **CARD**.  
 There are 4 submenus within the C. PLAY MENU.

- 1 To card operations submenu  
 2 To VCR set up submenu  
 3 To display set up submenu  
 4 To system submenu  
 5 Close main menu

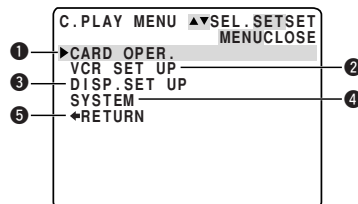

# E

## C. PLAY MENU, cont.

### 1 Card operations submenu

- ① To image protect ..... 107
- ② To print mark ..... 115
- ③ Copy from card to cassette ..... 114
- ④ Image erase ..... 108
- ⑤ Format ..... 116
- ⑥ Return

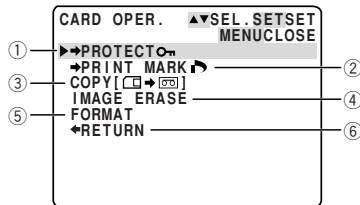

### 2 VCR set up submenu

- ⑦ Record mode ..... 21
- ⑧ AV or headphones ..... 31
- ⑨ Return

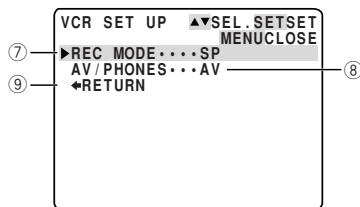

### 3 Display set up submenu

- ⑩ Brightness ..... 25
- ⑪ Displays ..... 137
- ⑫ Date/time select ..... 78
- ⑬ Return

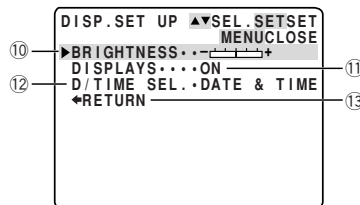

### 4 System submenu

- ⑭ Wireless controller ..... 46
- ⑮ Light-up buttons ..... 48
- ⑯ Button light color ..... 48
- ⑰ Beep ..... 22
- ⑱ Return

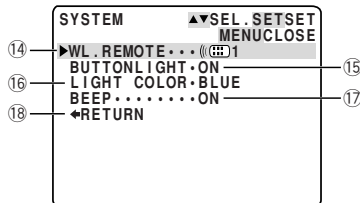







Using the Full Range of Features

## Using the Wireless Controller

The supplied wireless controller can operate the camcorder from a distance of up to 16 feet (5 m). Point it at the camcorder's remote sensor while you press the buttons.

There are some functions that cannot be operated without the wireless controller:

- Special playback (  28)
- Photo/date search (  81)
- Zero set memory (  82)
- Audio mix (  94)
- AV insert (  88)
- Audio dubbing (  91)
- Data code (  78)

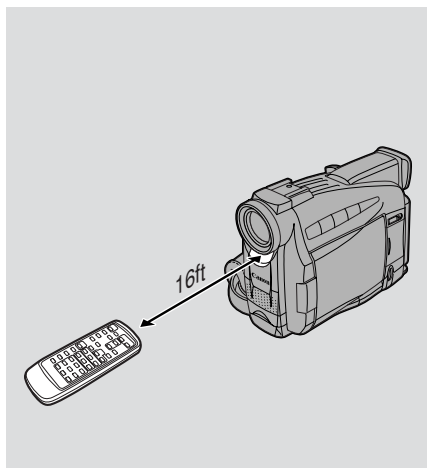

E

## Inserting batteries

Insert two AA batteries, following the  $\oplus$  and  $\ominus$  markings. Be careful not to reverse the polarity of the batteries.

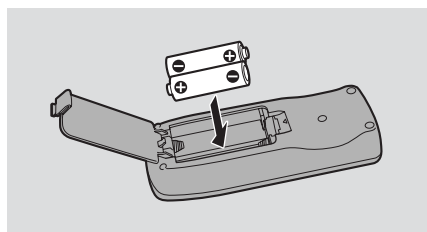

### Notes:

- When using the wireless controller in brightly lit places or outdoors, the effective range will be less.
- The camcorder may have difficulty picking up the remote control signals at extremely close range.
- Do not leave the controller exposed to direct sunlight, or in hot or humid places.
- When the batteries run out, replace them both together.
- If the wireless controller doesn't work, see p. 47.

Using the Full  
Range of Features

## When Operating 2 Canon DV Camcorders (Remote Sensor Mode)



To prevent interference from other Canon wireless controllers being used nearby, there are 2 remote sensor modes and an off setting. The wireless controller and the camcorder have to be set to the same mode in order to be compatible.

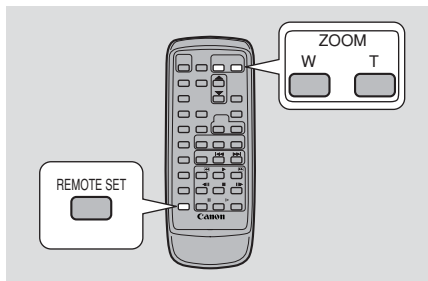

The wireless controller and the camcorder have been preset to mode 1. If you change the mode on the camcorder, be sure to change the mode on the wireless controller to the same mode.



**MENU**  
( 37 )



Ⓜ 1 : Mode 1  
Ⓜ 2 : Mode 2  
OFF Ⓜ : Sensor off

To turn the remote sensor off:

**Open the menu and select SYSTEM. Then select WL.REMOTE, set it to OFF Ⓜ and close the menu.**

- Ⓜ appears in the display.

To change the mode...

...on the camcorder:

**Open the menu and select SYSTEM. Then select WL.REMOTE, set it to Ⓜ 1 or Ⓜ 2 and close the menu.**

- The selected mode will appear on the display for 4 seconds.

...on the wireless controller:

**Press and hold the REMOTE SET button on the wireless controller.**

**Simultaneously press the ZOOM W button for mode 1 or the ZOOM T button for mode 2. Continue to press simultaneously for over 2 seconds.**

- Be sure to set the wireless controller to the same mode as the camcorder.

**If your wireless controller isn't working:**

Make sure the camcorder and the wireless controller are both set to the same mode. Check the mode the camcorder is set to by pushing any button other than the REMOTE SET button on the wireless controller. The camcorder's mode appears in purple for about 4 seconds. Set the wireless controller's mode accordingly by pressing the aforementioned button combinations. If the wireless controller still doesn't work, change the batteries.

**Note:**

- The mode the camcorder is set to also appears for 4 seconds when you turn the power on.

## Adjusting the Selectable Color Light-up Buttons

E

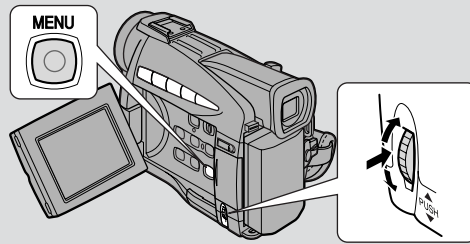

The clear buttons above the LCD panel light up when the camcorder's power is on, or only when one of the buttons is pressed, making it possible to play back cassettes when in dark surroundings. You can also change the color in which they light up to blue, turquoise (greenish blue) or green.

### Turning the buttons off



**TAPE** + **CAMERA** , **TAPE** + **PLAY (VCR)** , **CARD** + **CAMERA** , **CARD** + **PLAY (VCR)**

**MENU**

( 37 )

▶SYSTEM

▶▶BUTTONLIGHT-ON

To change the setting, open the menu and select **SYSTEM**. Then select **BUTTONLIGHT** and set it to **PUSH ON** or **OFF** and close the menu.

- **ON**: The buttons remain lit in the indicated color. While one of the buttons is pressed, all the buttons simultaneously change colors in the 3-color sequence. When the button is released, they return to the original color after a few seconds.
- **PUSH ON**: Buttons light up only while one of them is pressed. Then, all the buttons simultaneously change colors in the 3-color sequence. When the button is released, they turn off again after a few seconds.
- **OFF**: Buttons do not light up.

### Changing the color of the buttons



**TAPE** + **CAMERA** , **TAPE** + **PLAY (VCR)** , **CARD** + **CAMERA** , **CARD** + **PLAY (VCR)**

**MENU**

( 37 )

▶SYSTEM

▶▶LIGHT COLOR-BLUE

To change the color from blue, open the menu and select **SYSTEM**. Then select **LIGHT COLOR**, set it to **TURQUOISE** or **GREEN** and close the menu.

**Note:**

- You cannot change **LIGHT COLOR** when **BUTTONLIGHT** is set to **PUSH ON** or **OFF**.

Using the Full  
Range of Features



## Setting the Date and Time

E

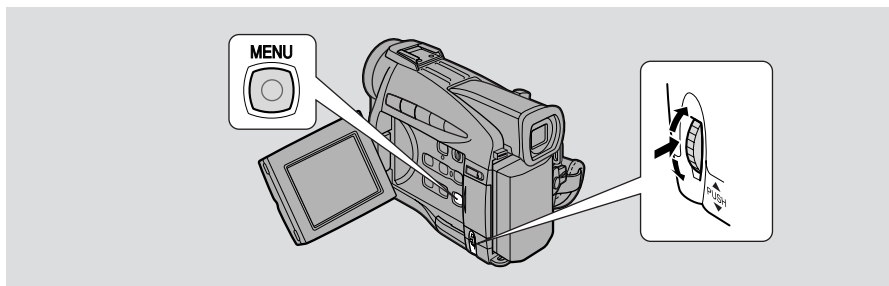

The date and/or time display forms part of the data code. You can choose to display or hide it during playback ( 78). Set the date and time display when you first start using your camcorder. Install the backup battery before you begin ( 124).

- Before you start setting the date and time, select your home time zone from the menu.

### Setting the time zone/daylight saving time



**TAPE** + **CAMERA** , **CARD** + **CAMERA**

**MENU**  
( 37)

▶SYSTEM

▶T.ZONE/DST•N.Y.

1. **Open the menu and select SYSTEM.**
2. **Select T.ZONE/DST.**
  - The time zone display appears on the screen.
  - Your camcorder's time zone is factory-preset to New York. If you are at another time zone, select your time zone first and daylight saving time (DST) setting if necessary.
3. **Move up or down the list of time zones with the selector dial. Select the option that represents your time zone.**
  - If you are now in daylight saving time, select the time zone with the daylight saving time mark  next to the area.
4. **Close the menu.**

Using the Full  
Range of Features

**E**

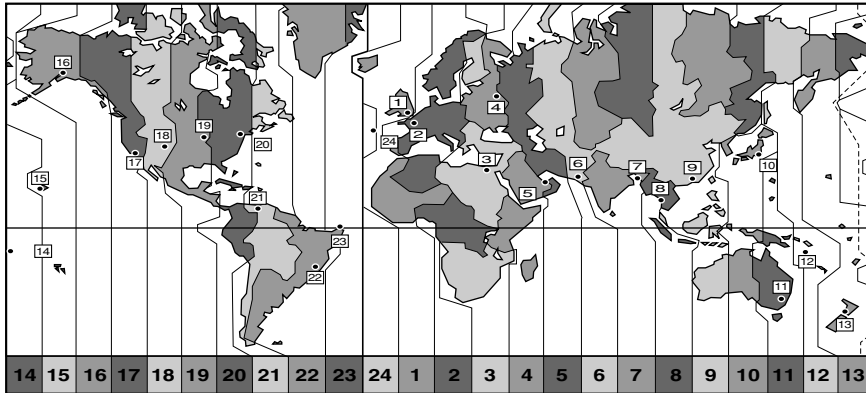

No.	Time zone	No.	Time zone
1	LONDON	13	WELLGTM (Wellington)
2	PARIS	14	SAMOA
3	CAIRO	15	HONOLU (Honolulu)
4	MOSCOW	16	ANCHOR (Anchorage)
5	DUBAI	17	L.A. (Los Angeles)
6	KARACHI	18	DENVER
7	DACCA	19	CHICAGO
8	BANGKOK	20	N.Y. (New York)
9	H. KONG (Hong Kong)	21	CARACAS
10	TOKYO	22	RIO (Rio de Janeiro)
11	SYDNEY	23	FERNAN. (Fernando de Noronha)
12	SOLOMON	24	AZORES

**Using the Full Range of Features**

**Notes:**

- After you have selected your time zone and set the date and time, when you travel to another time zone, there is no need to reset the date and time. Just set the time zone to your destination and the camcorder's clock will automatically change to display the correct time for your destination.
- The camcorder automatically accounts for the number of days in a month and leap year.

## Setting the clock



E

After you set the date and time, the date/time and home time zone will be displayed for about 4 seconds each time you turn the power on.

**TAPE** + **CAMERA** , **CARD** + **CAMERA**

**MENU**  
( 37)

▶ SYSTEM

▶ D/TIME SET...JAN. 1,2001  
12:00 AM

1. Open the menu and select **SYSTEM**.
2. Select **D/TIME SET**.
  - The year display starts to flash.
3. Turn the selector dial up and down to change the year. Press the dial in to move to another part of the display.
  - Once you move from the year, the next part of the display starts flashing.
4. Set the month, day, hours, and minutes in the same way.
5. Press the **MENU** button when finished, and to start the clock.

### Notes:

- To make a change to part of the date and time, press the selector dial in at step 3 to move to the part to be changed. Turn the dial to make the change, then close the menu.
- The date can be set to any year between 2001 and 2030.
- If you press the **MENU** button in the middle of setting the date and time, you leave the menu, and the clock starts.
- If you press the selector dial in after setting the minutes you can set the date and time again from the start.

## Date and time display



You can choose to display or hide the date and time display during recording. When the date and time display is set to ON, the date and time show in the lower left-hand corner of the display but the time zone disappears in about 4 seconds. The large, 4-second display will no longer appear when you turn on the power. It is not automatically superimposed on your recordings.

**TAPE** + **CAMERA** , **CARD** + **CAMERA**

**MENU**  
( 37)

▶ DISP.SET UP

▶ D/T DISPLAY·OFF

To turn it on, open the menu and select **DISP.SET UP**. Then select **D/T DISPLAY**, set it to ON and close the menu.

## Taking Still Pictures to a Cassette



E

To take still images on a memory card, see p. 101.

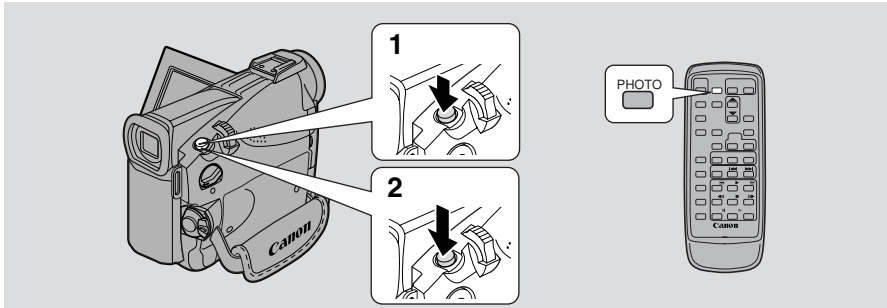

You can record still pictures like a photograph. The camcorder records the picture and sound to tape for several seconds. The exposure is automatically adjusted. Copy still photos automatically to a memory card ( 113) for transfer to a PC for image enhancement and printout. Also, starting your shooting with a still photo makes it easy to find the beginning again later with the Photo Search function ( 81).

You can take a still picture at any time during regular video recording, or you can put the camcorder into record pause mode first, then take a still picture.

**TAPE + CAMERA**

During record mode

**Press the PHOTO button fully down and the still picture will be taken immediately.**

- The camcorder takes the image immediately, and then records the “photo” to the tape for approximately 6 seconds\*. During this time the camcorder also records the sound, and the display shows the still picture.
- A counter display appears, and counts up as the camcorder records the picture.
- The camcorder returns to record pause mode.

During record pause mode

**1. Press the PHOTO button halfway down and hold it:**

- “PHOTO” flashes at the bottom right of display.
- Exposure is locked.
- During autofocus ● flashes white in the display as the camcorder adjusts the focus and it is displayed continuously as a green mark when the camcorder is ready to take the still picture.

Using the Full  
Range of Features

- If the subject is unsuitable for autofocus (📖 130), the camcorder may not be able to focus, and ● may continue to flash white in the display. Continue to hold the PHOTO button halfway down, then press the FOCUS button and adjust the focus manually with the selector dial.
- If you are using manual focus (📖 75), the ● mark starts as a continuous green mark. Focus with the selector dial.

## 2. Press the PHOTO button fully down to take the still picture.

- The camcorder takes the image immediately, and then records the “photo” to the tape for approximately 6 seconds\*. During this time the camcorder also records the sound, and the display shows the still picture.
- A counter display appears, and counts up as the camcorder records the picture. ● disappears from the display.
- The camcorder returns to record pause mode.



### Notes:

- The camcorder automatically returns to record pause mode after recording a still image for approximately 6 seconds\*. If you turn the POWER switch to OFF during that time, the camcorder will respond only after recording is complete.
- The wireless controller’s PHOTO button has no half-way setting. Press the button fully and the camcorder immediately takes the “photo”.
- Only take “photos” where it is bright enough to see the image in the display.

\*8 seconds in 📺SP or 📺LP recording mode.

## Searching and Reviewing While Recording

E

### Record search



When the camcorder is in record pause mode, you can use record search to play the tape forwards or backwards to find the point where you want to start or resume recording. This is useful when you want to add a new scene to a previously used cassette. By using record search, you can ensure a smooth, noise-free join between the new scene and the old one.

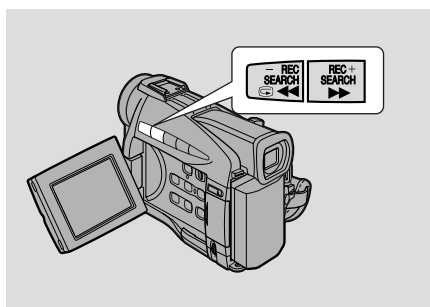

TAPE + CAMERA

1. **Press and hold the REC SEARCH + or – button on the camcorder while you check the picture in the display.**
  - The + button plays the recording forwards and the – button plays it backwards.
2. **Release the button when you find the point where you want to start recording.**
  - The camcorder returns to record pause mode.

Using the Full  
Range of Features

### Record review



When the camcorder is in record pause mode, you can use record review to play back the last few seconds of your recording and then return automatically to record pause mode. You can quickly make sure that a scene has recorded properly and then go on to shoot the next scene, without producing any noise in the picture.

TAPE + CAMERA

1. **Press and release the  (record review) button while you check the picture in the display.**
  - The camcorder rewinds the tape, plays back the last few seconds, and returns to record pause mode.

#### Note:

- Noise may appear on the screen when you play the tape backwards.

## Using the Various Recording Programs

E

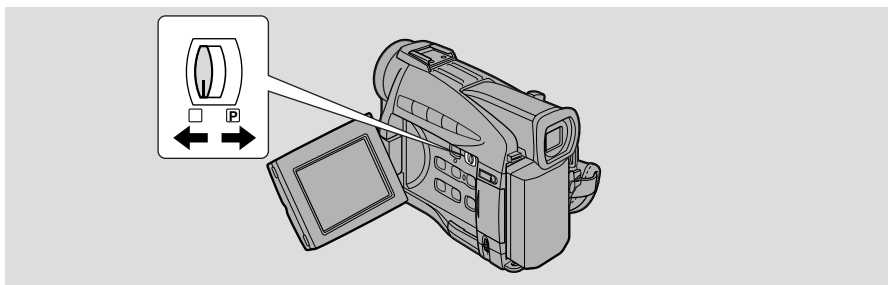

The camcorder provides you with a choice of 7 recording programs. They use different combinations of camcorder settings in order to adjust the exposure and other functions to match the recording situation.

- For simple point-and-shoot operation, select the Easy Recording program. Slide the program selector to the □ position.
- For normal shooting conditions, slide the program selector to P (program AE) mode. Open the program menu and select AUTO ( 56).
- For various other recording conditions, the camcorder has 5 more specialized AE (auto exposure) programs.

### Availability of functions in each recording program

Position of program selector							
Recording Program	□ (Easy Recording)	Auto	Sports	Portrait	Spotlight	Sand & Snow	Low Light
Shutter Speed	A	○	A				
Focus		○					
White balance		○					
AE Shift	×		○		×		○
Image stabilizer (ON/OFF)	ON	○					
Digital effects	×	○					
16:9	×	○					

○ : Available    × : Not available    A : Automatic function only

## Setting the program AE mode



**TAPE** + **CAMERA** , **CARD** + **CAMERA**

1. Slide the program selector to **P** (program AE) mode.
2. Press the selector dial in to display the program menu.
3. Turn the selector dial to move the arrow up or down the display.
4. Press the selector dial in to select the desired program.
  - The program will appear in the display.
5. Press the start/stop button to begin recording.



### Notes:

- The name of your selected recording program appears constantly on the left of the display, with the exception of Auto, which is displayed and then disappears after 4 seconds.
- Avoid changing programs during recording as the brightness of the image may change suddenly.
- If you switch the camcorder from the **□** program to the **P** program, the camcorder returns to the Auto program.
- When recording in dark places a bright light in the scene may cause a vertical light bar (“smear”) to appear. This is a normal feature of camcorders.





## Easy Recording

The simplest way to use the camcorder is with the program selector set to the  position. The camcorder will take care of focus, exposure and other adjustments, leaving you free to point and shoot.



## Auto

This is the same as the Easy Recording program, except that you now have the option of using any of the camcorder's manual functions.



## Sports

This program is useful for recording high-speed sports scenes in brightly lit conditions. Normal playback will be slightly jerky, but you will get clear images which can be analyzed frame by frame during slow or paused playback.



## Portrait

Use this program outdoors to make subjects stand out from a softened foreground and background. It works well for still-lives and close-ups. The effect is most noticeable when the zoom position is between the middle range and the telephoto end. Focus manually for maximum accuracy, and be careful when recording action scenes, as this program may cause fast moving objects to shudder.



**E****Spotlight**

This program is designed for recording spotlight scenes, such as on a stage. The exposure is automatically adjusted for glare-free recordings of subjects lit by a concentrated light source.

**Sand & Snow**

Use this program in places where the background is so bright that the subject appears underexposed in the display — a sunny beach or ski resort, for example. You may notice some shudder when recording moving subjects.

**Low Light**



This program allows you to record in dimly lit places. It is generally best used for close-ups of slow or stationary subjects, as moving subjects may leave a trailing after-image. However, you can take advantage of this to create special effects, by rapid zooming or by panning along with a moving subject. Picture quality will not be as good as in normal lighting conditions, and autofocus may not work as well as usual.



Using the Full  
Range of Features

## Using Digital Effects

Use the camcorder's digital effects for more interesting productions.

- **Faders:** Start or end scenes on a tape with a fade to or from black (  60). Fade Trigger, Vertical Wipe, Horizontal Wipe, Mosaic Fade\*
- **Effects:** Add flavor to your recordings (  61). Art, Black and White, Sepia, Mosaic
- **Multi-image Screen:** Divides the display to show 4, 9 or 16 still photos. Has 4 transition speed options: fast, moderate, slow and manual (  64).

\*Available during TAPE PLAY (VCR) mode only



### Availability of digital effects by mode

	TAPE CAMERA	PHOTO	TAPE PLAY (VCR)	CARD CAMERA	CARD PLAY (VCR)
Faders	○	×	○	×	×
Effects	○	○	○	○	×
Multi-image Screen	○	○	○	○	×

○ : Available    × : Not available

- The types of digital effects you are able to use depends on the setting of the TAPE/CARD switch, the POWER switch and the recording program.

### **Notes:**

- When you do not want to use digital effects, press the DIGITAL EFFECTS button and select D.EFFECT  from the digital effects menu. Press the DIGITAL EFFECTS button to close the menu.
- The camcorder remembers your chosen digital effect setting until you change it.
- Digital effects can be selected but not operated on a blank blue screen (appears in TAPE PLAY (VCR) mode). The display continues to flash.
- Digital effects operated during TAPE PLAY (VCR) mode are not recorded onto the original tape.
- Digital effects can be added to another tape when dubbing using the AV out terminal (TAPE PLAY (VCR) mode), but not the DV out terminal.
- You cannot operate digital effects while photo/date searching.
- If you slide the program selector to  (Easy Recording) while the digital effect display is flashing, it will disappear from the display and reappear when you return to  (program AE) mode.
- The digital effect display will flash for 2 seconds after setting, even if DISPLAYS is set to OFF in the menu.

E

## Faders

### Fade Trigger (FADE-T)

When you start recording, the scene gradually fades in from a black screen.

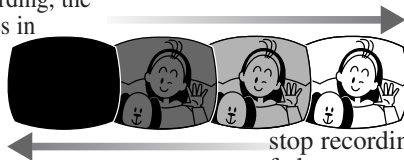

When you stop recording, it gradually fades out.

### Vertical Wipe (WIPE II)

When you start recording, the picture begins as a thin vertical line in the center of the screen which gradually expands sideways until it fills the whole of the screen.

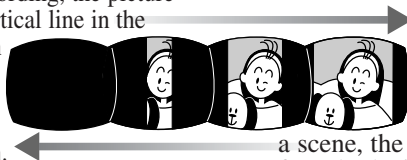

When you end a scene, the image is wiped from both sides of the screen.

### Horizontal Wipe (WIPE =)

When you start recording, the picture begins as a thin horizontal line in the center of the screen which gradually expands upwards and downwards until it fills the whole screen.

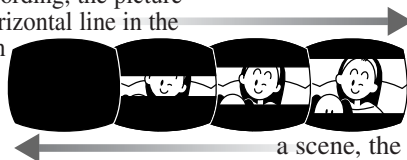

When you end a scene, the image is wiped from the top and bottom of screen.

### Mosaic Fade (M. FADE)\*

Blurs the image by enlarging the size of some pixels. The image appears as increasingly large squares of color as it fades out, and smaller squares when it fades in.

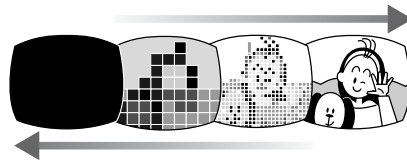

\*Available during TAPE PLAY (VCR) mode only.

# Effects



**Sepia (SEPIA)**  
Makes a monochrome image with a brownish tint.



**Art (ART)**  
Adds a paint-like effect, called solarization, to the image.



**Black and White (BLK & WHT)**  
Makes the image black and white.

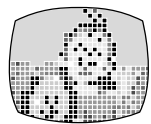

**Mosaic (MOSAIC)**  
Blurs the image by enlarging the size of some pixels.

## E

Digital effects can be set with the controls on the body of the camcorder or the wireless controller. Pressing the ▲/▼ buttons on the wireless controller correspond to turning the selector dial up and down, and pressing the SET button corresponds to pressing the selector dial in.

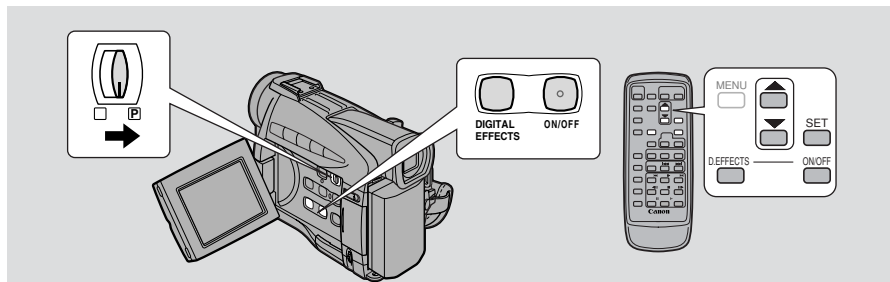

### Operating faders



Sound and image fade together.

When operating faders in TAPE CAMERA mode, make sure the program selector is set to

**TAPE** + **CAMERA** , **TAPE** + **PLAY (VCR)**

Select fader

1. **Press the DIGITAL EFFECTS button to open the digital effects menu.**
  - D.EFFECT **OFF**, FADER, EFFECT and MULTI-S appear.
2. **Select FADER.**
  - FADE-T, WIPE II, WIPE = settings appear. M.FADE also appears in TAPE PLAY (VCR) mode.
3. **Select the desired setting.**
  - You return to the digital effects menu.
4. **Press the DIGITAL EFFECTS button to close the menu.**
  - The name of your selected fader flashes in the display.

Fader on/off

5. **Press the ON/OFF button.**
  - The name of your selection stops flashing.
  - Each time you press the ON/OFF button, the chosen fader is activated (display lights continuously) or deactivated (display flashes).

6. If you're in TAPE CAMERA mode:

**Fade in-** Press the start/stop button.

**Fade out-** Press the start/stop button.

If you're in TAPE PLAY (VCR) mode:

**Fade in-** Press the ► (play) button.

**Fade out-** Press the || (pause) button.

### Operating effects



Sound records/plays back normally.

When operating effects in TAPE CAMERA or CARD CAMERA mode, make sure the program selector is set to [P].



Select effect

1. Press the **DIGITAL EFFECTS** button to open the digital effects menu.

- D.EFFECT **OFF**, FADER, EFFECT and MULTI-S appear.

2. Select **EFFECT**.

- ART, BLK&WHT, SEPIA, MOSAIC settings appear.

3. Select the desired setting.

- You return to the digital effects menu.

4. Press the **DIGITAL EFFECTS** button to close the menu.

- The menu disappears and the name of your selected setting flashes in the display.

Effect on/off

5. If you're in TAPE PLAY (VCR) mode, press the ► (play) button.

6. Press the **ON/OFF** button.

- The name of your selection stops flashing and takes effect on the display.
- Each time you press the ON/OFF button, the chosen effect is activated or deactivated.

## Using the Multi-Image Screen

E

Divides your display image into 4, 9 or 16 smaller images with the Image Capture feature. With this feature, the camcorder captures the current scene being shot or replayed. Choose the transition speed — manual, fast (every 4 frames), moderate (every 6 frames) or slow (every 8 frames) — at which to capture a moving subject, such as a person playing tennis or golf. Sound is recorded normally.

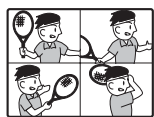

4 images



9 images



16 images

### Operating the multi-image screen



When operating the multi-image screen in TAPE CAMERA or CARD CAMERA mode, make sure the program selector is set to **P**.

In TAPE PLAY (VCR) mode, you can only operate the multi-image screen in the following playback modes:

When M.S.SPEED is set to MANUAL: Still picture playback, slow forward/reverse playback

When M.S.SPEED is set to FAST, MODERATE or SLOW: Still picture playback

**TAPE** + **CAMERA** , **TAPE** + **PLAY (VCR)** , **CARD** + **CAMERA**

Select multi-image screen

1. **Press the DIGITAL EFFECTS button to open the digital effects menu.**
  - D.EFFECT **OFF**, FADER, EFFECT and MULTI-S appear.
2. **Select MULTI-S.**
  - M.S. SPEED and M.S. SPLIT settings appear.
3. **Select M.S. SPEED.**
  - MANUAL, FAST, MODERATE and SLOW settings appear.
4. **Select the desired setting.**
  - You return to the digital effects menu.
5. **Select MULTI-S again.**
  - M.S. SPEED and M.S. SPLIT settings appear.
6. **Select M.S.SPLIT.**
  - 4, 9, 16 settings appear.
7. **Select the desired setting.**
  - You return to the digital effects menu.

Using the Full  
Range of Features



**8. Press the DIGITAL EFFECTS button to close the menu.**

- The digital effects menu disappears.
- MULTI-S flashes in the display.

Multi-image screen on/off

**9. Push the ON/OFF button.**

- MULTI-S stops flashing.
- Manual: As you press the ON/OFF button, scenes will be captured one after another the indicated number of times. If you push and hold the ON/OFF button for more than a second, the last image captured will be erased.
- The currently recording image is framed in blue. The frame disappears after the last image is captured.
- Automatic: The camcorder will capture the indicated number of images at the indicated speed.

**10. If you're in TAPE CAMERA mode, push the start/stop button to begin recording.**

- The multi-image screen is recorded to the tape.

**If you're in CARD CAMERA mode, press the PHOTO button to record the multi-image screen to the memory card.**

**Notes:**

- You can operate the multi-image screen from record or record pause mode.
- After all the images have been captured, press the ON/OFF button quickly to cancel the multi-image screen.
- If you are operating the multi-image screen in TAPE PLAY (VCR) mode and you stop or pause the tape, or press any other playback button or the date/photo search buttons, the multi-image screen will be canceled. (This does not apply with the MANUAL multi-image speed.)
- You cannot use digital zoom or the 16:9 mode when the multi-image screen is set. The display becomes “— —”.

## Audio Recording

E

### Selecting the audio mode



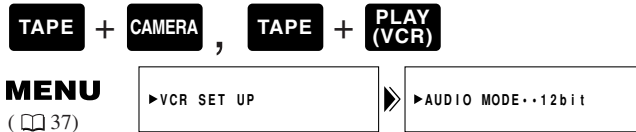

ZR30 MC can record sound on a tape in two audio modes — 16-bit and 12-bit. The 16-bit mode produces the higher sound quality (slightly superior to CD) while the 12-bit mode records on two channels (stereo 1), leaving 2 channels free (stereo 2) for you to add new sound at a later date.



To switch to the 16-bit mode, open the menu and select VCR SET UP. Then select AUDIO MODE, set it to “16 bit” and close the menu.

- “16 bit” is shown in the display for approximately 4 seconds.

#### Notes:

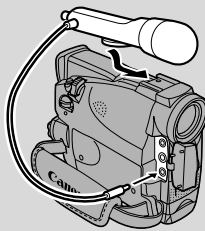

- For details on adding new sound, see p. 91.
- For details of playing back a tape that has new sound on stereo 2, see p. 94.
- When you record to the ZR30 MC from a camcorder with DV terminal outputs, the audio mode becomes automatically set to 12 bit.
- When the recording mode is set to  SP or  LP mode, the audio mode becomes automatically set to 12 bit.

### External microphone



For greater creative control over audio recording, you can connect an external microphone to the camcorder via the MIC terminal. When using the MIC terminal, use a microphone with a built-in power supply (condenser microphone). It is possible to connect almost any stereo microphone with a plug diameter of  $\frac{1}{8}$  inch (3.5 mm), however, their audio levels will be different from that of the built-in microphone.

### Notes:

- For details on using the optional DM-50 microphone, see p. 71.
- Be careful when using long microphones as they may extend into the frame.
- You can monitor the sound while recording by setting the AV/headphone terminal to headphones (  31) and attaching stereo headphones to the  terminal.

## Wind screen

The camcorder has an automatic wind screen to prevent wind noise from interfering with the sound track. Make sure it's off when you want the microphone to be as sensitive as possible. Use the wind screen when recording in windy places such as the beach or near buildings.



### MENU

(  37)



**To turn it on, open the menu and select VCR SET UP. Then select WIND SCREEN, set it to ON and close the menu.**

- WS **ON** is shown in the display when you turn the wind screen on.

### Notes:

- The wind screen can be used for audio dubbing with the built-in microphone as well as recording.
- The wind screen does not operate when an external microphone is connected to the MIC terminal or the advanced accessory shoe.

## Setting the Self-Timer



E

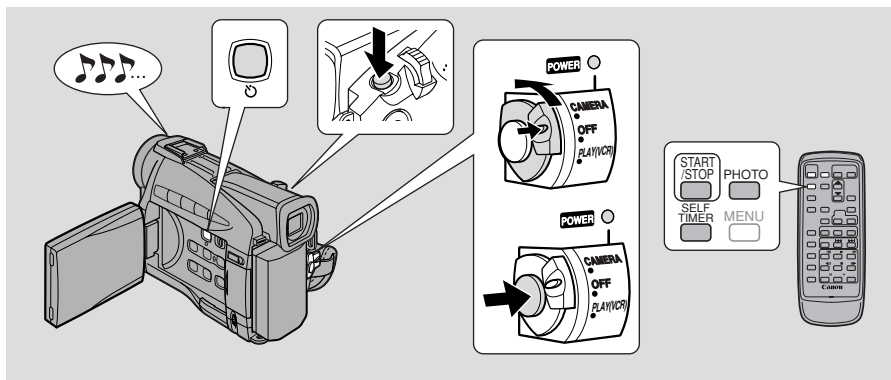

This is useful when you want to include yourself in the picture when recording movies or still photographs.

**TAPE + CAMERA** , **CARD + CAMERA**

### 1. Press the self-timer button on the body of the camcorder

or

### the **SELF TIMER** button on the wireless controller.

- SELF-T appears in the display.
- To have the subject monitor recording, rotate the LCD panel 180° (  26).

For movies





### 2. Press the start/stop button.

- The camcorder starts to record after a 10-second countdown period (or after 2 seconds when you use the wireless controller). The time remaining counts down in the display (e.g. “5 SEC”).
- SELF-T disappears from the display when recording begins.



### 3. Press the start/stop button to end recording.

For stills

### 2. Press a **PHOTO** button on the camcorder body or the wireless controller.

- The camcorder automatically adjusts the focus 2 seconds before the countdown is complete. The  mark flashes white then turns green after the focus and exposure are set. If you are using the wireless controller, the  mark starts flashing immediately after you press the PHOTO button.
- The camcorder takes the picture for approximately 6 seconds (8 seconds in  SP or  LP recording mode).

 **Notes:**

- To cancel the self-timer before the countdown has begun, press the  SELF TIMER button.
- To cancel the self-timer once the countdown has begun, press the  SELF TIMER button, start/stop if you're shooting movies, or PHOTO if you're taking a still image.

E

  
Using the Full  
Range of Features

## Using the VL-3 Video Light (optional)

E

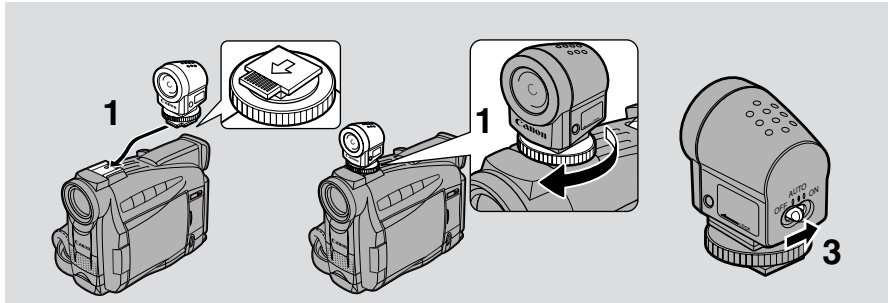

When recording in dark rooms, attach the Video Light to the camcorder's "S" advanced accessory shoe. The Video Light is powered by the same power source as the camcorder.

Also refer to the VL-3 Video Light instructions.

Turn the camcorder's power off before attaching/removing the Video Light.

### 1. Slide the Video Light onto the accessory shoe and tighten with the shoe lock.

- Slide in the direction of the arrow on the bottom of the Video Light until it clicks securely into place.
- Make sure that the light does not come disconnected when turning the shoe lock.

### 2. Set the camcorder to TAPE CAMERA mode or CARD CAMERA mode.

### 3. Turn the Video Light's power switch to AUTO or ON.

-  (Connection) appears in the display.
- **ON:** The Video Light stays on.
- **AUTO:** The Video Light turns on/off automatically according to the level of brightness of the shooting conditions.
  - When the Video Light is set to AUTO, it will not turn itself on/off while the camcorder is recording a still picture, even if the brightness of the surroundings changes.



### Caution:

- Be careful not to touch the bulb or the surrounding area during or immediately after use; it becomes very hot. Keep the Video Light away from flammable or plastic materials.
- Do not look directly at the bulb while the Video Light is on.
- Never carry the camcorder holding the Video Light.

## Using the DM-50 Microphone (optional)

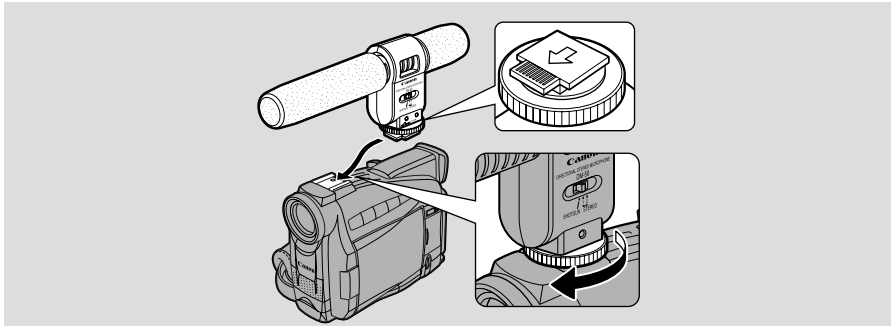
E



The highly sensitive Directional Stereo Microphone DM-50 has been designed exclusively for camcorders equipped with an advanced accessory shoe . It is powered by the camcorder's power supply. Use during cassette recording or audio dubbing ( 91).

Refer to the DM-50's instructions for further details.

Turn the camcorder's power off before attaching/removing the microphone.

### 1. Slide the microphone onto the accessory shoe and tighten with the shoe lock.

- Slide in the direction of the arrow on the bottom of the microphone until it clicks securely into place.
- Make sure that the microphone does not come disconnected when turning the shoe lock.

### 2. Set the camcorder to TAPE CAMERA mode.

-  (Connection) appears in the display.

### 3. Set the microphone's directivity switch.

**SHOTGUN:** Clearly picks up sound arriving from the front of the microphone (monaural).

**STEREO1:** Picks up sound arriving from the front of, as well as sound surrounding the microphone.

**STEREO2:** Picks up sound surrounding the microphone in a wider range than STEREO 1.

### Notes:

- Never carry the camcorder holding the microphone.
- Do not use any other external microphones while the DM-50 is connected to the advanced accessory shoe.

## Using AE Shift

E

By controlling the level of the automatic exposure (AE) function, you can lighten or darken the image slightly. This allows you to compensate for backlit, overexposed scenes.

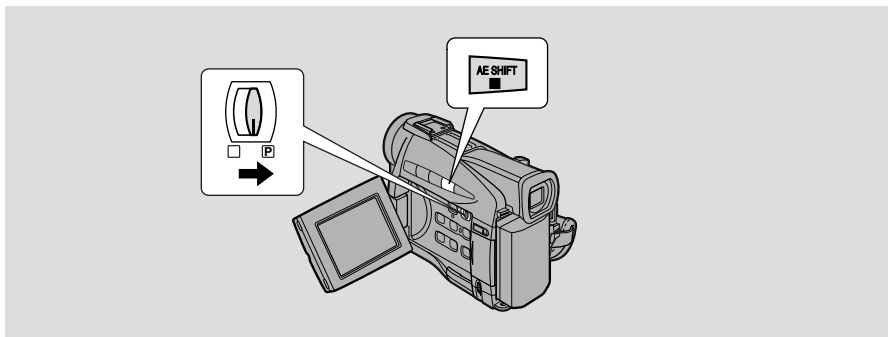

**TAPE** + **CAMERA** , **CARD** + **CAMERA**

Make sure the program selector is set to **P**.

- 1. Press the selector dial in and select any recording program other than Spotlight or Sand & Snow from the program menu.**
- 2. Press the AE SHIFT button.**
  - ▶ AE appears light blue.
- 3. Turn the selector dial to choose your desired level.**
  - Levels are from -2 to +2, in 0.25 intervals (excluding -1.75 and +1.75).
  - The higher the setting, the brighter the image.

### **Notes:**

- You cannot adjust the exposure without the ▶ mark before AE in the display. Push the AE SHIFT button so that ▶ appears before AE. Then you can adjust the exposure manually.
- You cannot adjust the AE Shift when the camcorder is set to  (Easy Recording), the Spotlight recording program or the Sand & Snow recording program.



## Setting the Shutter Speed



Set the shutter speed manually to take stable shots of quickly moving subjects.

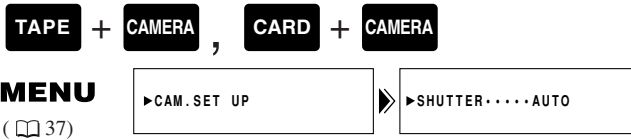

E

1. Make sure the camcorder is set to the (program AE) mode.
2. Press the selector dial in and choose AUTO from the program menu.
3. Open the menu and select CAM.SET UP.
4. Select SHUTTER.
5. Press the selector dial in to select the desired shutter speed.

<u>TAPE</u>		<u>CARD</u>
AUTO	↑ slower ↑	AUTO
1/60		1/60
1/100		1/100
1/250		1/250
1/500		
1/1000		
1/2000		
1/4000		
1/8000	↓ faster ↓	

- Only shutter speeds up to 1/250 are available when using a memory card.

6. Close the menu.

### Concerning shooting in fluorescent lighting

When the camcorder is set to (Easy Recording) or the Auto recording program, it automatically detects the flicker of fluorescent lighting and adjusts the shutter speed to compensate. However, if the brightness of the LCD or viewfinder display starts to flicker, make sure the camcorder is set to the Auto recording program and select the 1/100 shutter speed.

### Guidelines for shooting using high shutter speeds

- When shooting with a shutter speed of 1/1000 or higher, do not shoot the sun directly.

### Recommended shutter speeds when shooting:

- People doing outdoor sports such as golf or tennis



1/2000 or 1/4000  
(or 1/8000 to freeze the action even more clearly)

- Moving cars or trains or other rapidly moving vehicles such as roller coasters



1/1000, 1/500 or  
1/250

- People doing indoor sports such as basketball



1/100

### Notes:

- You are unable to set the shutter speed in any recording program other than AUTO. The SHUTTER display becomes set to “— — —.”
- The image may not appear smooth when a high shutter speed is set.
- The camcorder returns to the auto shutter setting when you slide the program selector to  (Easy Recording), or change the recording program.
- If you set the shutter speed to 1/500 or above in TAPE CAMERA mode and then switch the camcorder to CARD CAMERA mode, the shutter speed will automatically change to 1/250.

## Adjusting Focus Manually

The camcorder can focus automatically. All you have to do is point it, and whatever is in the center of the display will usually be in sharp focus. If it does not seem to be focusing well, it may be because the subject is not suitable for autofocus.

E

You can use the manual focusing function for more control over focusing.

### Focus lock



**TAPE** + **CAMERA** , **CARD** + **CAMERA**

Press the FOCUS button to turn off autofocus. The focus remains locked at the point set by autofocus.

(▶M.FOCUS appears in the display.)

You can now adjust the focus manually with the selector dial. Press the FOCUS button again when you want to return to autofocus.

- If you zoom in on your subject after turning off autofocus, it may not stay in focus. It is generally best to adjust the zoom first, and then the focus.

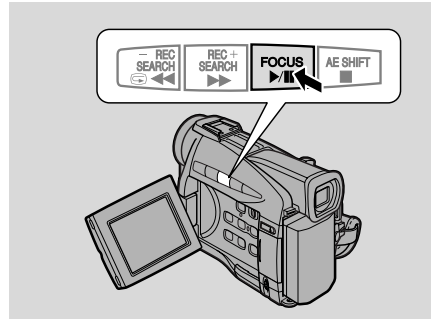

### Manual focus



**TAPE** + **CAMERA** , **CARD** + **CAMERA**

Use the selector dial to set the focus.

- Turn the selector dial downward to move the focus farther away.
- Turn the selector dial upwards to bring the focus nearer.

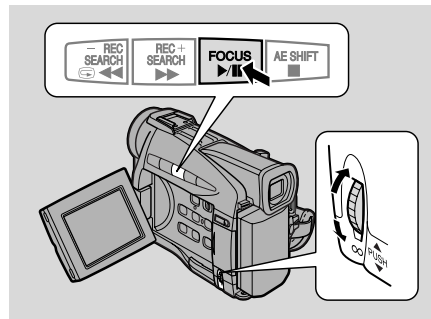

### Notes:

- You cannot adjust the focus without the ▶ mark before M.FOCUS in the display. Push the FOCUS button so that ▶ appears before M.FOCUS. Then you can adjust the focus manually.
- The manual focus setting is canceled if you select the  (Easy Recording) program.
- When you are using the  (Easy Recording) program, autofocus cannot be turned off.
- See “Troubleshooting” on p. 129 for a list of subjects which may not be suitable for autofocus.

Using the Full  
Range of Features

## Setting the White Balance



E

The camcorder's auto white balance system compensates for a wide range of lighting conditions. Although slight variations are unavoidable, colors will appear natural in virtually every situation.

In some cases, you will get better results by setting the white balance yourself, or using one of the two preset modes:

- Indoor Mode
  - Under halogen or studio/video lighting
  - Subject is of one dominant color
  - Close ups
- Outdoor mode
  - In daylight, especially for close-ups and where the subject is of one dominant color

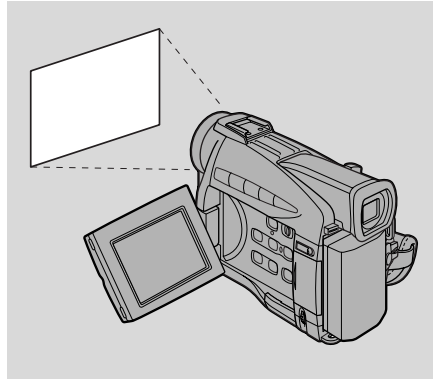

TAPE + CAMERA , CARD + CAMERA

MENU  
( 37)

▶CAM.SET UP

▶WHITE BAL...AUTO

Using the Full  
Range of Features

1. Make sure the camcorder is set to the **P** (program AE) mode.
2. Open the menu and select CAM.SET UP.
3. Select WHITE BAL.
4. a) **For the indoor, outdoor or auto settings, press the selector dial in to choose the setting.**
  - **☺/☼** appears in the display when you set the white balance to indoor/outdoor mode.b) **To set the white balance yourself, point the camcorder at a white object (such as a sheet of paper) and zoom in until it fills the display. Then press the selector dial in to select SET **☑**.**
  - Make sure to continue pointing the camcorder at the white object until you have finished setting the white balance.
  - The **☑** display flashes then remains lit.
  - Depending on the light source, the flashing may at times continue. The result will remain better than with the auto setting and you can continue recording.
5. Close the menu.

Setting the white balance manually will probably work better than auto white balance when shooting:

Subjects with one dominant color, such as sky, sea or forest



Close-ups



In rapidly changing lighting conditions



In places lit by certain types of fluorescent or mercury vapor lights



#### Notes:

- Turn the digital zoom off (if necessary) to set a more accurate white balance.
- If you have set the white balance and lighting conditions change, reset the white balance.
- Try to record with light from a single source. Correct white balance cannot be obtained for two types of lighting at once.
- You cannot set the white balance or choose the indoor/outdoor mode when the program selector is set to the  (Easy Recording) program.
- The white balance returns to the AUTO setting when you slide the program selector to  (Easy Recording).
- When you turn the camcorder on, the white balance returns to AUTO. If you then switch the white balance to SET, the camcorder will remember your last setting.
- During normal outdoor shooting, setting to AUTO may provide better results.

## Displaying Date, Time and Camcorder Data (Data Code)

E

A data code, containing the date and time the recording was made and other camcorder data (shutter speed and exposure settings) is automatically recorded on a special data section of the tape.

- Only the date and time appear in the data code when using a memory card.

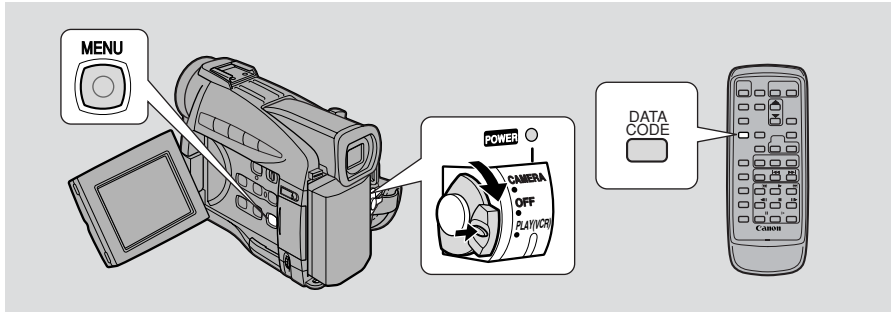

During TAPE PLAY (VCR) mode, the data code can be displayed or hidden while the camcorder is in play, slow or still mode.

Camcorder data may be displayed as “- - -” during fast forward, rewind, reverse playback, forward and reverse  $\times 2$  playback.

**Press the DATA CODE button on the wireless controller. When using a cassette, press it while the camcorder is in play, slow or still mode.**

- Press it once to display, once more to hide it.

Using the Full  
Range of Features

### Selecting date/time



Select whether you want the date, the time, or both to show up on your data code display ( 79).

**TAPE** + **PLAY (VCR)** , **CARD** + **PLAY (VCR)**

**MENU**  
( 37)

► DISP.SET UP

►► D/TIME SEL..DATE & TIME

To change the date and time combination, open the menu and select **DISP.SET UP**. Then select **D/TIME SEL.**, set it to **DATE**, **TIME** or **DATE & TIME** and close the menu.

## Setting the data code



E

You can also choose to display camcorder data (shutter speed and exposure settings) in cassette data codes.

**TAPE** + **PLAY (VCR)**

**MENU**

( 37)

▶ DISP.SET UP

▶▶ DATA CODE...DATE/TIME

To change, open the menu and select **DISP.SET UP**. Then select **DATA CODE**, set it to **DATE/TIME**, **CAMERA DATA** or **CAM. & D/T** and close the menu.

Possible data code combinations for cassettes:

DATA CODE (cassette only) D/TIME SEL.	Date/Time	Camera data	Date/Time & Camera data
Date	JAN. 1, 2001	F32 1/250	F32 1/250 JAN. 1, 2001
Time	12:00:00 AM	F32 1/250	F32 1/250 12:00:00 AM
Date & Time	12:00 AM JAN. 1, 2001	F32 1/250	F32 1/250 12:00 AM JAN. 1, 2001

### Notes:

- The data code will read “-- --” in the following situations:
  - During playback of a blank section of tape.
  - If the tape was recorded before entering the date and time in the camcorder’s memory.
  - If the tape was recorded on a camcorder without a data code function.
  - If noise or tape damage prevents the data code from being read.
- If a recording made on ZR30 MC is played back on a different DV camcorder, the data code may not be displayed correctly.
- The data code will appear in the display even if DISPLAYS ( 137) has been set to OFF through the menu.

**E****Six-second auto date**

The 6-second auto date appears for 6 seconds to mark the changeover of a day if the tape was being recorded at 12:00 midnight. It also appears for 6 seconds when you start playback and have the data code turned off. The 6-second auto date will adjust for any time zone changes you have indicated.

**MENU**

( 37)

▶ DISP.SET UP



▶ 6SEC. DATE...OFF

To turn the 6-second auto date on, open the menu and select **DISP.SET UP**. Then select **6SEC. DATE**, set it to **ON** and close the menu.

**Note:**

- When 6SEC.DATE is turned on but DISPLAYS ( 137) is turned off, the 6-second auto date will still appear for 6 seconds.



## Searching the Tape (Photo Search/Date Search)

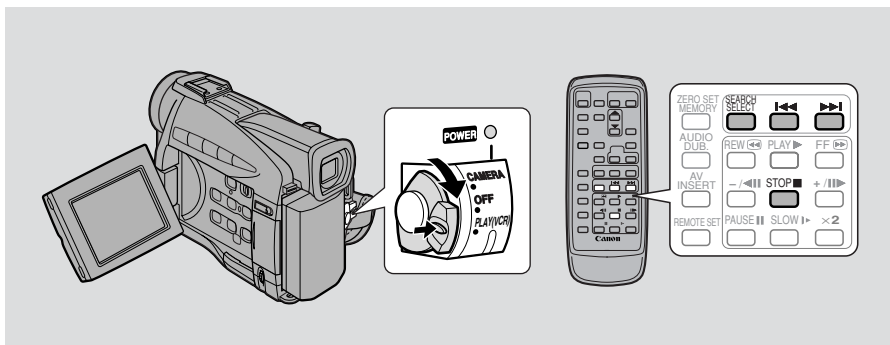

E

This allows you to move quickly through still pictures recorded anywhere on a tape (photo search) or between different days or areas of recording (date search) on a tape.

**TAPE** + **PLAY (VCR)**

### 1. Press the **SEARCH SELECT** button to choose between photo/date search.

- PHOTO SEARCH or DATE SEARCH is shown in the display for 4 seconds.

### 2. Press the **◀◀** and **▶▶** buttons to move backwards or forwards through the still pictures or between different days of recording.

- Press once to move to the start of the previous/next still picture or day on the tape.
- You can press more than once to move to the corresponding still picture or day (up to a maximum of 10 times), e.g. press the **▶▶** button 5 times to move forward 5 still pictures or days.
- PHOTO SEARCH/DATE SEARCH appears in the middle of the display alongside the **◀◀** or **▶▶** mark and number to search through. You can change direction easily by pressing the button for the opposite direction.

#### **Notes:**

- Press **■** (stop) to stop mid-search.
- If you begin a search very close to the start of a recorded still picture during photo search, the camcorder may skip straight past it.
- When you have set the area for the World Clock, date search also looks for the change in date based on the adjusted time.
- A date/area cannot be identified if the total recording time on that day/area was less than 1 minute.
- Date search playback may start just before or after the beginning of the located section.
- If the data code is not displayed correctly you will not be able to operate the date search correctly.

## Returning to a Pre-Marked Position



E

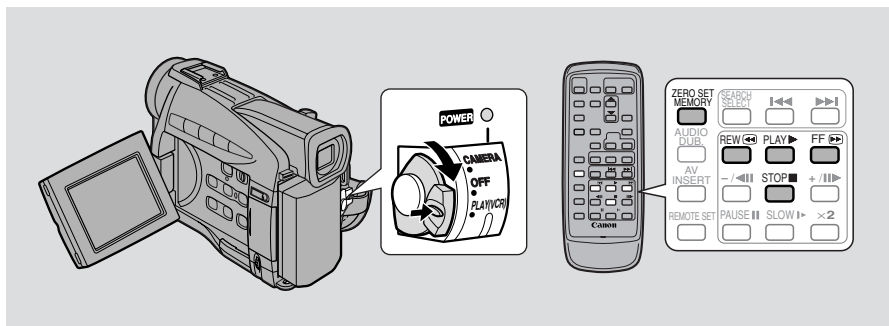

Use the wireless controller to mark a point on a tape that you want to return to following playback.

**TAPE** + **CAMERA** , **TAPE** + **PLAY (VCR)**

### 1. Press the **ZERO SET MEMORY** button on the wireless controller during playback at a point you want to return to later.

- The time code is replaced by a tape counter that is set to zero with the **M** indication.
- Press the **ZERO SET MEMORY** button once more to cancel the zero set memory.

### 2. When you have finished playback, fast forward or rewind the tape. The tape stops automatically when it reaches the zero set position.

- **RTN▶▶** or **◀◀RTN** appears in the display.
- The tape counter with **M** indication disappears from the display and the time code reappears.



#### Notes:

- The zero set memory may not function correctly where there is a break between recordings on the tape.
- You can also use zero set memory to mark a position on a tape in **TAPE CAMERA** mode. When you then play back the tape, pressing rewind will take you back to the pre-marked position.
- If you remove the tape while the zero set memory is set, the memory is canceled and the tape counter reverts to time code.
- The camcorder remembers your setting even if you turn it off and back on again or move the program selector.

## Editing to a VCR

By connecting the camcorder to a VCR, you can edit your recordings in order to remove unwanted scenes — or combine different shots to create your own video productions.

E

### Preparations

- 1. Connect the camcorder to the VCR.**
  - See “Connections for Playback on a TV Screen” on p. 31.
- 2. Prepare the TV and VCR.**
  - Turn on the TV and set the TV/VIDEO selector to VIDEO.
  - Turn on the VCR, and set its input selector to LINE. Load a blank cassette, and put the VCR in record pause mode.
  - See your TV and VCR instruction manuals for details.
- 3. Turn the camcorder’s POWER switch to PLAY (VCR), and move the camcorder’s TAPE/CARD switch to TAPE. Load your recorded cassette.**

### Editing



- 1. Find a point on your recorded cassette slightly before the section you want to copy.**
- 2. Start to play it back while you monitor the picture on the TV.**
- 3. Start recording on the VCR as soon as the section you want to copy appears on the screen.**
- 4. Pause the VCR at the end of the section you want to copy, then stop playback on the camcorder.**
- 5. Repeat steps 1 to 4 until your edited recording is complete.**



#### Note:

- The quality of the edited tape will be slightly lower than that of the original.

### Ⓛ (LANC) terminal

The Ⓛ terminal allows you to connect the camcorder to equipment. Some buttons on editing equipment may operate differently from those on the camcorder.

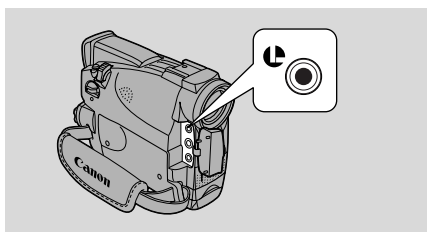

#### Notes:

- Ⓛ (LANC) is a trademark. It stands for Local Application Control Bus System.
- We cannot guarantee the results when connecting to equipment not bearing the LANC Ⓛ symbol.

Editing

## Dubbing to/from a Cassette with Digital Video Equipment

E

Digital video equipment fitted with the DV terminal lets you edit, copy and transfer data digitally, with virtually no generation loss in image and sound quality. The DV terminal is for both line-in and line-out, since a single DV cable can handle data in both directions.

- If a digital VCR is connected and an anomalous signal is sent from the VCR, the images recorded on the tape may also be anomalous (although it may not appear so on the TV image), or not recorded at all.
- You are unable to dub tapes recorded with the copyright protective signal.

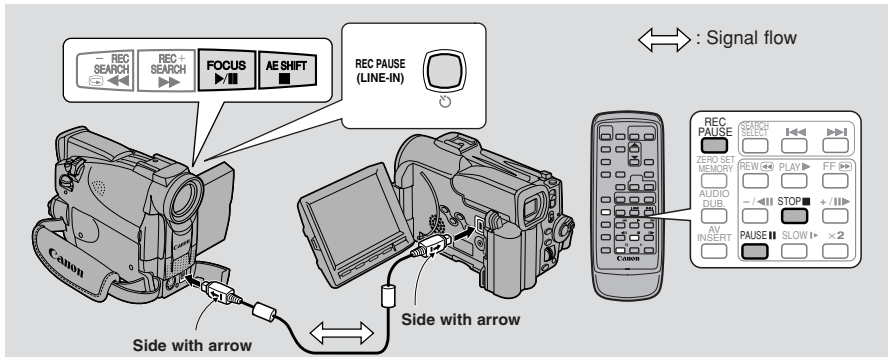

### Preparations

Example dubbing to the camcorder

- 1. Connect the camcorder and the other digital device.**
  - Connect the Canon CV-150F DV cable (optional) with the sides of the plugs marked with the arrows facing as shown above.
- 2. Prepare the other device.**
  - Turn on the power and load a recorded cassette.
- 3. Turn the camcorder's POWER switch to PLAY (VCR), and move the camcorder's TAPE/CARD switch to TAPE.**
  - DV IN appears in the display.
- 4. Load a blank cassette.**

Editing

## Dubbing



E

1. Find a point on your recorded cassette slightly before the section you want to copy and set it to playback pause mode.
2. Press the camcorder's REC PAUSE button.
  - The camcorder enters record pause mode.
3. Start playback on the other digital device while you monitor the picture.
4. Press the pause button.
  - Recording starts.
5. When you get to the point where you want to stop recording, press the stop button or the pause button.
  - Recording stops.
6. Stop playback on the other device.



### Notes:

- If the cable is not connected properly, or if the cable is unconnected when you press REC PAUSE, the camcorder displays the caution "CHECK THE DV INPUT." An anomalous image may also flash onto the screen.
- Blanks between recordings on the playback tape are recorded as anomalous images on the tape that is being recorded to.
- During DV dubbing you cannot add digital effects.

## Copyright signal

Certain pre-recorded software tapes are copyright protected. If you try to play back such a cassette, "COPYRIGHT PROTECTED PLAYBACK IS RESTRICTED" appears in the display for a few seconds and then the camcorder displays a blank blue screen; you cannot view the contents of the cassette. If you try to record from such a tape via the digital cable "COPYRIGHT PROTECTED DUBBING RESTRICTED" appears in the display; you cannot record the contents of the tape.

## Recording from a VCR, TV or Analog Camcorder (Analog Line-in)

E

You can record a video played on your VCR or analog camcorder (for digital camcorders, see p. 84) or a TV program onto a tape in the ZR30 MC, if the TV or other device has audio/video outputs.

- If an anomalous signal is sent from the TV or VCR, the images recorded on the tape may also be anomalous (although it may not appear so on the TV image), not recorded at all, or COPYRIGHT PROTECTED DUBBING RESTRICTED may appear in the display.
- You are unable to dub tapes recorded with the copyright protective signal.

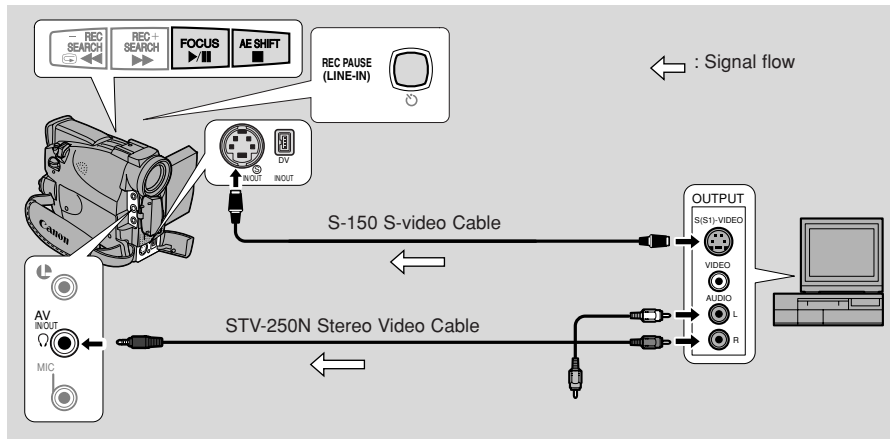

You cannot use headphones while doing analog line-in recording. If you have the AV/headphones terminal set to headphones, it will automatically switch to AV for analog line-in recording. PHONES disappears from the display.

### Preparations

1. **Connect the camcorder to the VCR, TV or other camcorder.**
2. **Prepare the device. (Example connecting to the VCR)**
  - Set the TV/Video selector on the television to Video. For further details, see “Connections for Playback on a TV Screen” on p. 31.
  - Turn on the VCR. Load your recorded cassette, and put the VCR in playback pause mode.
  - See your TV and VCR instruction manuals for details.
3. **Turn the camcorder's POWER switch to PLAY (VCR), and move the camcorder's TAPE/CARD switch to TAPE.**
4. **Load a blank cassette.**



- 1. Find a point on your recorded cassette slightly before the section you want to copy and set it to playback pause mode.**
- 2. Press the REC PAUSE button.**
  - S-video and AV IN/OUT terminals work as input terminals.
  - The camcorder enters record pause mode.
- 3. Start playback on the other device or turn on the TV to see the desired program while you monitor the picture.**
- 4. Press the pause button.**
  - Recording starts.
- 5. When you get to the point where you want to stop recording, press the stop button or the pause button.**
  - Recording stops.
- 6. Stop playback on the other device.**



**Note:**

- You can monitor the picture in the viewfinder or LCD.

## Recording Over Existing Scenes (AV Insert Editing)

E

You can insert new scenes from your VCR or other camcorder onto your pre-recorded tape using the ZR30 MC's analog line-in or DV in terminals. Original video and audio will be replaced with the new video and audio.

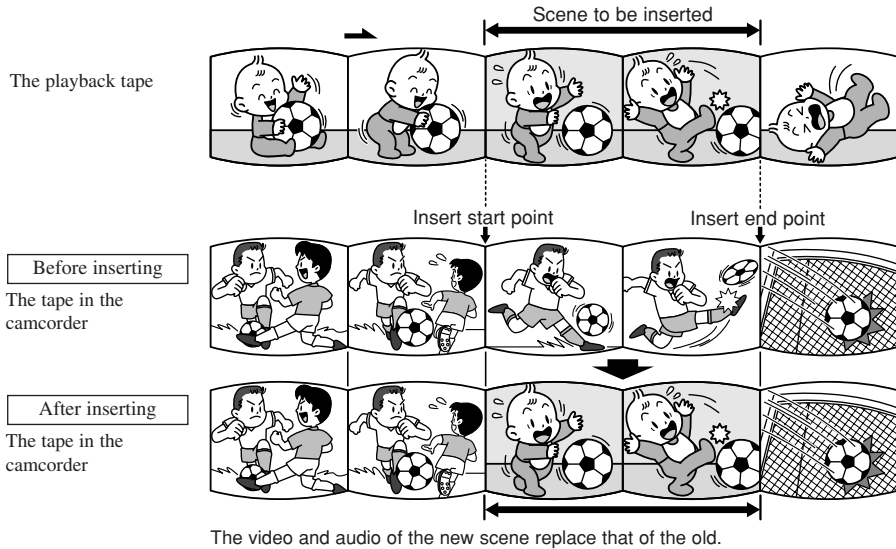

Editing

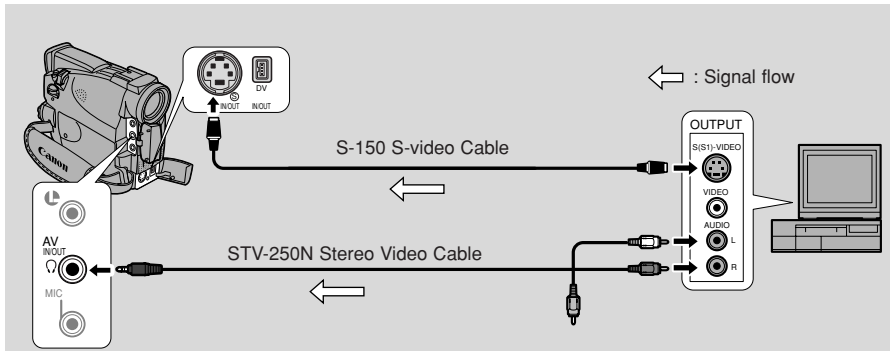

Make sure the AV/headphone terminal is set to AV through the menu ( 31). If PHONES appears in the display, switch the terminal.

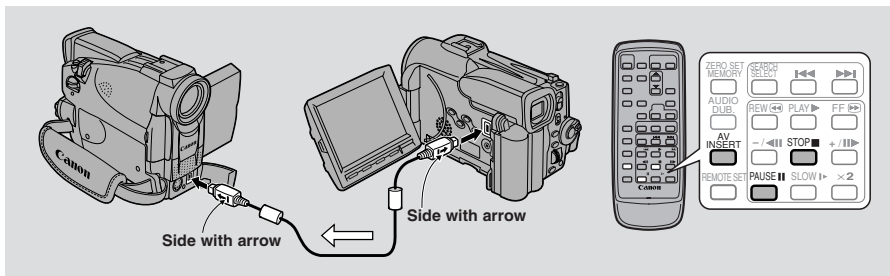



## Preparations

E

### The tape in the camcorder:

When using the ZR30 MC's AV insert function, only record to tapes recorded in SP mode with continuously recorded time codes.

If there are non-recorded portions or portions recorded in a mode other than SP mode on the tape, recording will stop.

### The playback tape:

Use only tapes without non-recorded portions.

If there are non-recorded portions or changes in the recording mode, you may not be able to insert AV correctly.

You cannot insert AV in the following cases:

- The playback tape has been poorly recorded.
- During special playback: fast forward playback, rewind playback or slow playback etc. (analog only).

### TV:

You cannot insert AV from a TV program with anomalous synchronized signals, such as when the program itself received poor signals.

#### Example recording from a VCR

- 1. Connect the camcorder to the VCR.**
- 2. Prepare the VCR and TV.**
  - Set the TV/Video selector on the television to Video. For further details, see "Connections for Playback on a TV Screen" on p. 31.
  - Turn on the VCR and load a recorded cassette.
  - See your TV and VCR instruction manuals for details.
- 3. Turn the camcorder's POWER switch to PLAY (VCR) and load a recorded cassette.**
  - Make sure the REC/SAVE tab on the cassette has been slid to REC (closed position).
- 4. Move the camcorder's TAPE/CARD switch to TAPE.**



Editing



1. **On the VCR, locate a point 3 seconds before the scene to be inserted. Set the VCR to playback pause mode.**
2. **On the camcorder, press PLAY and locate the recording start point. Set the camcorder to playback pause mode.**
  - You can use the playback buttons on the body of the camcorder or the special playback functions on the wireless controller in the same way as in playback mode.
3. **Press the AV INSERT button.**
  - AV INSERT and ●|| appear in the display.
4. **Play back the cassette in the VCR.**
5. **To start inserting, press the PAUSE button on the camcorder.**
  - ●|| changes to ●.
6. **To stop inserting, press the STOP button on the camcorder.**
  - Inserting stops and AV INSERT disappears from the display. The camcorder returns to stop mode.
  - If instead of pressing STOP you press PAUSE, the camcorder returns to the AV insert pause mode.
  - If you set the zero set memory at the position on the tape where you want to stop inserting, every time you return to that point, the camcorder will cancel its AV inserting and enter stop mode.
7. **Stop playback on the VCR.**

## Audio Dubbing

E

You can add sound to the original sound on a pre-recorded tape from audio products (AUDIO IN) or with the internal or external microphone (MIC. IN). The original sound will not be erased. For best results, add sound to tapes that have been recorded with this camcorder in SP mode with 12-bit sound. If there are non-recorded portions on the tape, or portions recorded in a mode other than SP mode, or with 16-bit or 12-bit, 4-channel sound, dubbing will stop. If your tape hasn't been recorded in SP mode with 12-bit sound, we recommend dubbing your original tape onto a blank tape using the ZR30 MC's analog line-in function, then dubbing audio onto the new tape. Make absolutely sure to set the audio mode of the new tape to 12-bit and the recording mode to SP.

### To connect other audio equipment:

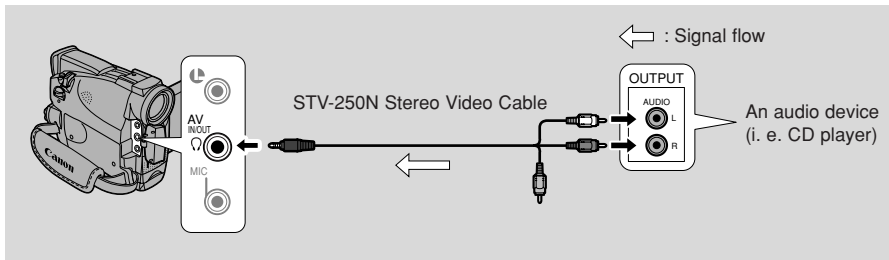

- Make sure the AV/headphone terminal is set to AV through the menu ( 31). If PHONES appears in the display, switch the terminal.

### Notes:

- Do not use the yellow video terminal.
- The AV terminal doesn't put out any video, so connect the S-video terminals and check your TV, or check the LCD or the viewfinder as you add new sound. Always check the new sound with the speaker.

### To connect an external microphone:

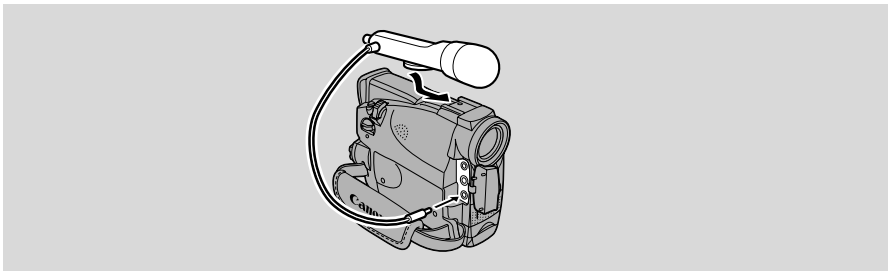

**E**

**Notes:**

- **When using an external microphone** → Connect it to the microphone terminal.
- **When using the DM-50 microphone** → Make sure nothing is connected to the microphone terminal.
- **When using the built-in microphone** → Make sure nothing is connected to either the microphone terminal or the accessory shoe.
- To use your TV to monitor video, connect the S-video terminal ( 32) or the AV terminal (use only the video plug) to your TV. You can monitor the sound with headphones only when using the S-video terminal ( 31).

**Preparations**

Turn the camcorder's POWER switch to PLAY (VCR) and move the camcorder's TAPE/CARD switch to TAPE. Load a recorded cassette.

- Make sure the REC/SAVE tab on the cassette has been slid to REC (closed position).

**Dubbing**



Editing

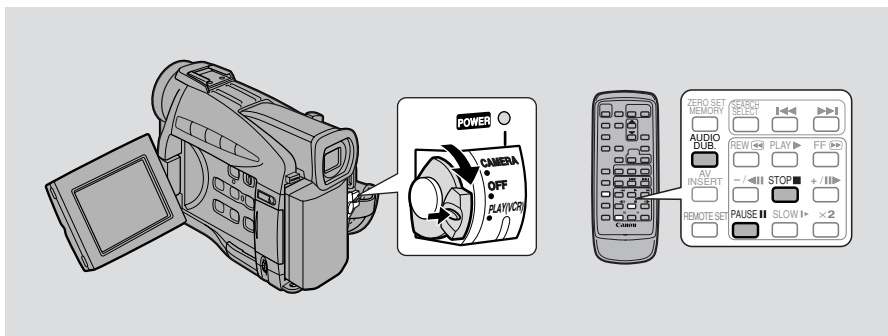

Do not connect/disconnect any cables to/from the camcorder when dubbing audio or preparing to dub audio.





**TAPE** + **PLAY (VCR)**

**MENU**

( 37)



1. Open the menu and select **VCR SET UP**.
2. Select **AUDIO DUB**.
3. Select **AUDIO IN** or **MIC. IN** and close the menu.

4. **Locate the point where you want to start audio dubbing, then press the PAUSE button.**
  - You can use the playback buttons on the body of the camcorder or the special playback functions on the wireless controller in the same way as in playback mode.
  - The camcorder becomes set to playback pause mode.
5. **Press AUDIO DUB.**
  - AUDIO DUB. and  appear on the display.
  - If you have the DM-50 microphone (optional) attached,  (Connection) appears in the display.
6. **Press the PAUSE button (and start play on the other audio device if AUDIO IN).**
  - Audio dubbing starts.
  - If MIC. IN, direct your voice into the microphone.
  -  changes to .
7. **When you get to the point where you want to stop dubbing, press the STOP button (and then stop play on the other audio device if AUDIO IN).**
  - Audio dubbing stops and AUDIO DUB. disappears from the display.
  - The camcorder returns to stop mode.
  - You can also set zero set memory ( 82) at the place you want to stop audio dubbing, then every time you return to that position, audio dubbing will cancel.
  - If instead of pressing STOP you press PAUSE, the camcorder will return to the playback pause mode.



#### Notes:

- You cannot use the DV terminal while adding sound.
- You might want to adjust the audio mix ( 94) when playing back a tape with added sound.
- There may be a loss of sound quality if you add sound to a tape recorded on a camcorder other than the ZR30 MC.
- After adding sound 3 or more times to the same place on a tape, there may be some loss in sound quality.

## Setting the Audio Mix



E

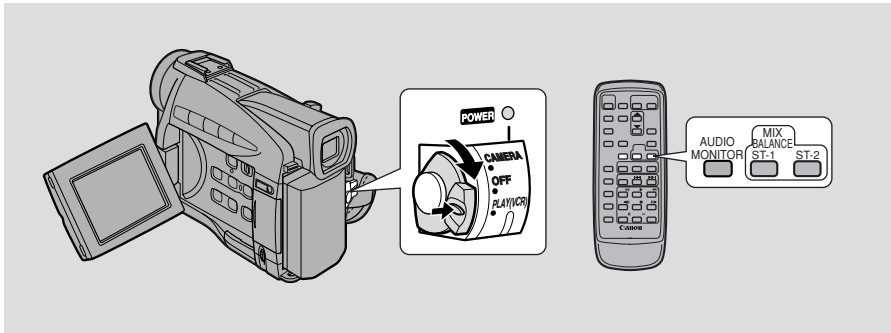

When you play back a tape that was recorded in 12-bit mode, you can set the audio output to play: stereo 1 (the original sound), stereo 2 (any new sound, dubbed to the tape after recording), or mix the balance between the two.

- Audio from the 16-bit mode only contains stereo 1 sound and so you cannot/do not need to select the audio mix. The same is true for the 12-bit stereo 1 mode, unless new sound has been added post-recording.

**TAPE** + **PLAY (VCR)**

### Choose the output.

- Press **AUDIO MONITOR** on the wireless controller.
- Starting with the last selected setting, 4 settings appear as you push the button:
  - **STEREO1** for just stereo 1.
  - **STEREO2** for just stereo 2.
  - **MIX/FIXED** for an equal mix of stereo 1 and 2.
  - **MIX/VARI.** (mix variable) for when you want to mix the balance between stereo 1 and 2.
- To simply choose **STEREO1**, **STEREO2** or **MIX/FIXED**, make sure your choice appears on the display.
- If you choose **MIX/VARI.**, you can go on to mix the balance.
- Use the **ST-1/ST-2** keys to mix the balance. A bar showing the mix appears on the screen for 4 seconds.

### **Note:**

- When you have chosen the output, **STEREO1**, **STEREO2**, **MIX/FIXED** or **MIX/VARI.** is shown in the top left of the display for a few seconds. If you turn the power off the output is set to **STEREO1**.

## Selecting audio output channels



E

When you play back a tape whose audio has been recorded on multiple channels, you can change the output channels of that sound.



**MENU**

( 37)



1. Load a tape recorded with multiple-channel audio.
2. Open the menu and select **VCR SET UP**. Then select **OUTPUT CH**, set it to the desired setting and close the menu.
  - Refer to the following list.

OUTPUT CH setting	Played back sound	
	Tape recorded with stereo sound	Tape recorded on multiple channels
L/R	L+R channels	main + sub
L/L	L channel only	main only
R/R	R channel only	sub only

  
 Editing

## Connecting to a PC

E

By using a DV cable and connecting the camcorder to a PC equipped with a DV terminal conforming to IEEE 1394/DV compatible capture board, you can transfer images taken with the camcorder to your PC.

- While connected, it is recommended that you power your camcorder from a household power socket using the power adapter.
- Turn off the power of both the camcorder and the PC before connecting.
- Optional software necessary.

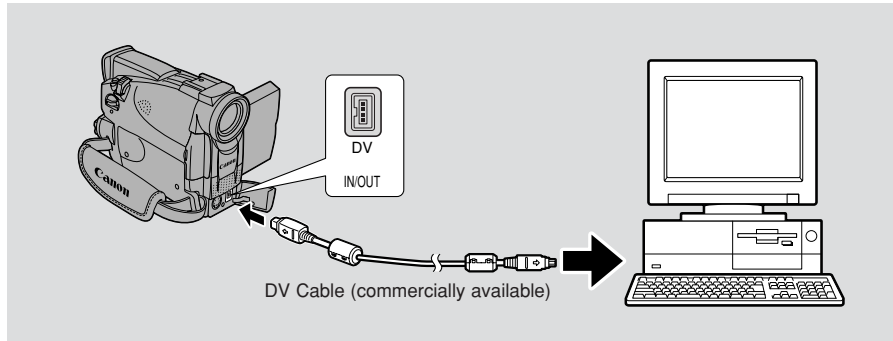

### Note:

- Operation may not work correctly, depending on the software you are using, and the specifications of your PC and its settings.



## Memory Card Introduction

E

The camcorder can take, store and manage still images on 2 types of memory cards: the MultiMediaCard (supplied with the camcorder) or an SD Memory Card (commercially available). The MultiMediaCard is an ultra-small, ultra-light media that can record still images. About the same size as a MultiMediaCard, the SD (Secure Digital) Memory Card has a large capacity for recording still images, and fits into the same slot as the MultiMediaCard.

### You can do the following with a memory card:

- Record still images (📖 101)
- View still images 3 ways: Single (📖 105), Slide show (📖 106), Index screen (📖 106)
- Select the quality of images recorded on the card (📖 98)
- Protect important images against accidental erasure (📖 107)
- Erase (📖 108) and print mark (📖 115) still images
- Create interesting effects by combining images (📖 110)
- Record a still image from a cassette (📖 103)
- Copy multiple still images automatically to and from a cassette (📖 113, 114)

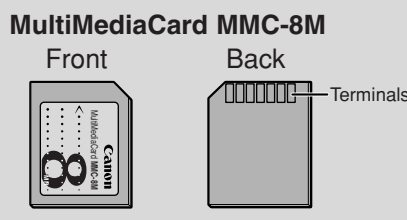

You can use most of the camcorder's functions when recording to a memory card, such as the various recording programs (📖 55), self-timer (📖 68), shutter speed (📖 73), white balance (📖 76) and other manual adjustments. Available functions are marked with the **CARD** + **CAMERA** or **CARD** + **PLAY (VCR)** icons.

- While the camcorder is recording the still image, >>>> appears red\* in the display.
    - While >>>> appears red in the display, do not remove the memory card or disconnect the power source. Doing so could result in data damage.
  - While the camcorder is retrieving a still image, <<<< appears green\* in the display.
    - While <<<< appears green in the display, do not remove the memory card. Doing so could result in data damage.
- \* It appears white when in mirror mode and on the screen of a connected TV.

### Important

- Inserting or removing the memory card without first setting the POWER switch to OFF can result in data damage.
- This camcorder uses only MultiMediaCards or SD Memory Cards(  \*\*). You cannot use any other types of memory cards.

\*\*  logo is a trademark.

## Inserting and removing the memory card

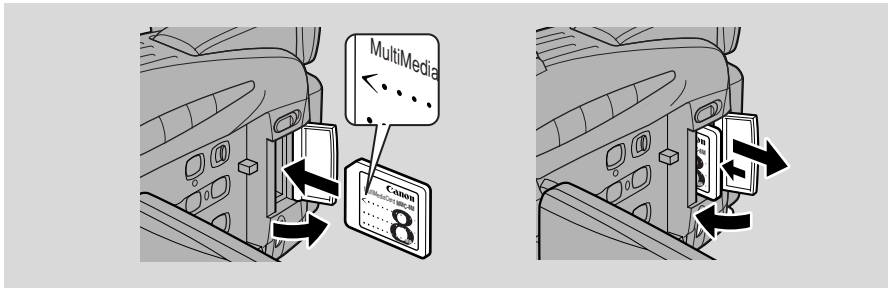

1. Turn the **POWER** switch to **OFF**.
2. Open the memory card compartment cover in the direction of the arrow.
3. **Insert or remove the memory card.**
  - Push the memory card all the way in.
  - Remove the memory card by pushing the card in and letting it spring out.

Do not attempt to pull the memory card out without first pushing it in.

4. Close the cover.

### **Notes:**

- When you set the camcorder to **CARD PLAY (VCR)** mode, the last image recorded appears. If there are no images recorded on the memory card, **NO IMAGES** appears in the display.
- Do not touch the memory card terminals.

## Selecting the recording image quality

Select the quality of a still image to be recorded.

**TAPE** + **PLAY (VCR)** , **CARD** + **CAMERA**

### **MENU**

(  37 )



To change the image quality to standard, open the menu and select **CARD SET UP**. Then select **QUALITY**, set it to **STANDARD** and close the menu.

 **Notes:**

- Depending on the image you are recording, sometimes there will be no difference in image quality between settings.
- Images are compressed and recorded in the JPEG (Joint Photographic Experts Group) format.
- The number of pixels is  $640 \times 480$  (VGA) in both FINE and STANDARD modes.

Image quality	Necessary memory per image	Number of images per 8MB MMC*	Use when you want to...
FINE	Approx. 124 KB	Approx. 60 images	...save high quality images, print out, etc.
STANDARD	Approx. 70 KB	Approx. 105 images	...attach images to Emails, include them in your own home page, etc.

\* These figures are approximate. The actual number you will be able to record varies depending on the images. Remember that the sample images already recorded on the supplied MultiMediaCard are included in the total number.

- The number of images that can still be recorded on a memory card may sometimes decrease by 2 images at once.
- Refer to p. 140 for the memory card displays.





The images you take are automatically assigned file numbers from 0001-9900 and stored in folders of 100 images each. Each folder is numbered from 100 to 998 and recorded on the memory card. Sample images have been pre-recorded on the supplied MultiMediaCard, entering folder number 100.

Set the image file numbers so that they reset each time a new memory card is inserted, or so that they count up continuously.

### 1 CONTINUOUS

Numbering is continuous between cards, so that the first file number assigned on a new memory card is 1 more than the last file number assigned on the previous memory card. When the file numbers are set to CONTINUOUS, each image taken is assigned a different number, avoiding duplication of numbers. This is convenient when you want to manage your images on a PC. We recommend keeping the file numbers set to CONTINUOUS.

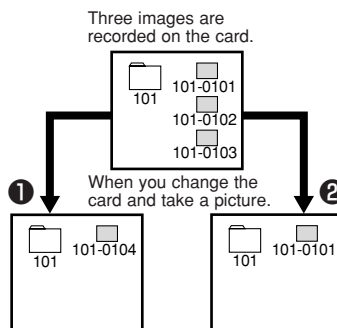

### 2 RESET

Each time you insert a new memory card, the file number resets to its default value (101-0101). If the card already contains files, the next available number is assigned.

**TAPE** + **PLAY (VCR)**, **CARD** + **CAMERA**

### MENU

( 37)

▶ CARD SET UP

▶ FILE NOS. . . . CONTINUOUS

To change the file numbering, open the menu and select **CARD SET UP**. Then select **FILE NOS.**, set it to **RESET** and close the menu.

## Recording Still Images to a Memory Card

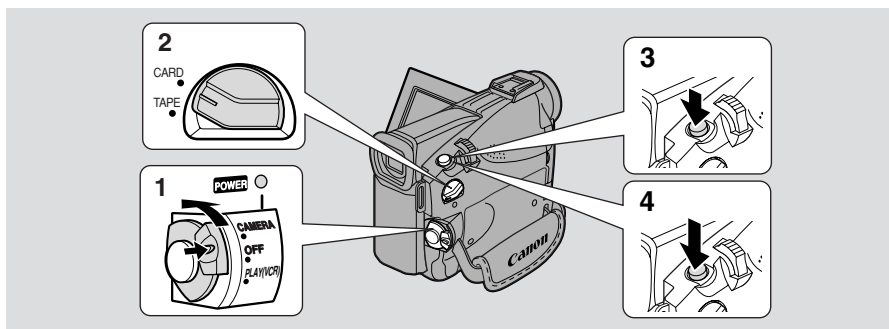

E

The camcorder's Progressive Photo function lets you take vivid, virtually blur-free still images of moving subjects onto a memory card. You can also record onto a memory card images from a tape in the camcorder, or images input through the DV in terminal.

- Moving pictures cannot be recorded onto a memory card.
- Images input through the AV in terminal cannot be recorded onto a memory card.
- Memory cards cannot record audio.
- If you are using an SD Memory Card, make sure the protect switch is set to allow recording.

Make sure a memory card that has enough memory available is inserted into the camcorder.

- 1. Press the small green button on the POWER switch and hold, turn the POWER switch to CAMERA.**
- 2. Move the TAPE/CARD switch to CARD.**
  - The number of images that can still be recorded on the memory card, and other information appear in the display.
  - The camcorder will turn itself off if you are using a battery and do not operate the camcorder for more than about 5 minutes. Set the POWER switch to OFF and then back to CAMERA.
- 3. Press the PHOTO button halfway and hold it.**
  - Exposure is locked.
  - During autofocus ● flashes white in the display as the camcorder adjust the focus and it is displayed continuously as a green mark when the camcorder is ready to take the still image.
- 4. Press the PHOTO button fully down to record the still picture.**
  - ● disappears from the display.
  - The image is recorded to the memory card.
  - While the camcorder is recording the still image, >>>> appears red in the display. (It appears white when in mirror mode and on the screen of a connected TV.)

# E

## Notes:

- To use the self-timer ( 68), press the  button before step 3, and then press the PHOTO button fully down.
- The wireless controller's PHOTO button has no half-way setting. Press the button fully and the camcorder immediately takes the image.
- When the POWER switch is set to CAMERA and the TAPE/CARD switch is moved from TAPE to CARD, the camcorder modifies the image for appropriate recording onto a memory card.

## The indicators that appear in the display when recording to a memory card:

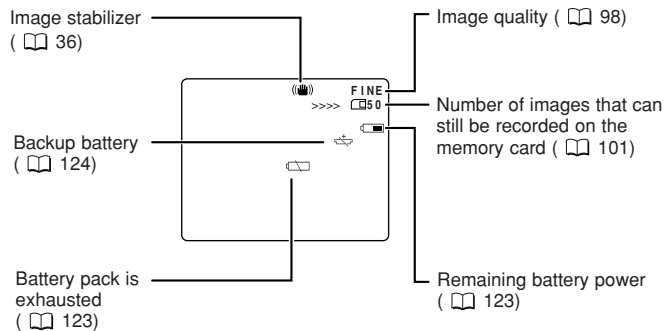

## Recording an Image from a Cassette as a Still Image

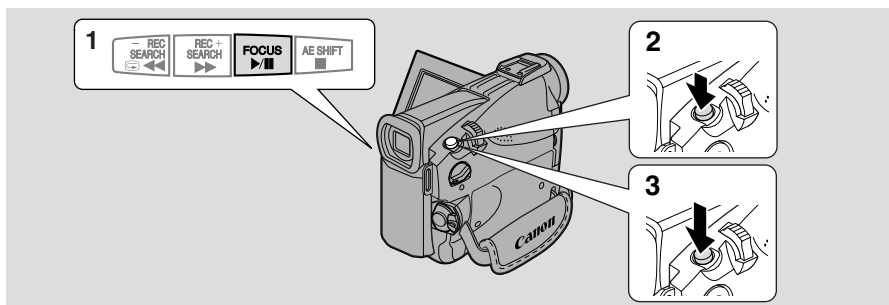

E

Record an image from a cassette onto a memory card. To automatically record multiple still images from a cassette to a memory card, refer to “Copying Still Images from a Cassette” on p.113.

- The still image’s data code will reflect the date and time it is recorded to the memory card.

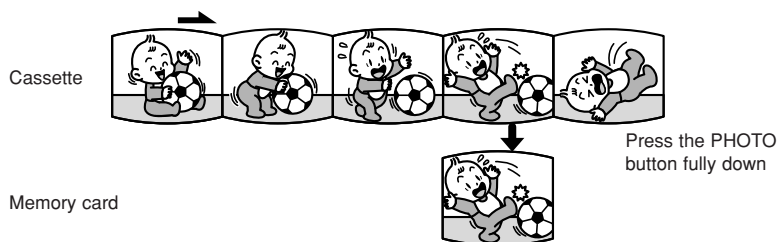

1. **Play back the cassette.**
2. **When the image you want to record appears in the display, press the PHOTO button halfway down and hold it.**
  - The tape is set to playback pause mode and the number of images that can still be recorded on the memory card appears in the display.
  - The display appears to close for an instant as if it were a shutter releasing (except when you are operating the multi-image screen).
3. **Press the PHOTO button fully down to record the image to the memory card.**

### **Notes:**

- You can also set the cassette to playback pause mode in step 1 and record the image with only 1 full press of the PHOTO button.
- If you record an image onto a memory card that was originally recorded in the 16:9 mode for widescreen TV’s, the image will appear to be vertically “squashed” (compressed).

## Recording from Another DV Device as a Still Image

E

Record images input through the DV in terminal onto the memory card as still images.

- The still image's data code will reflect the date and time it is recorded to the memory card.

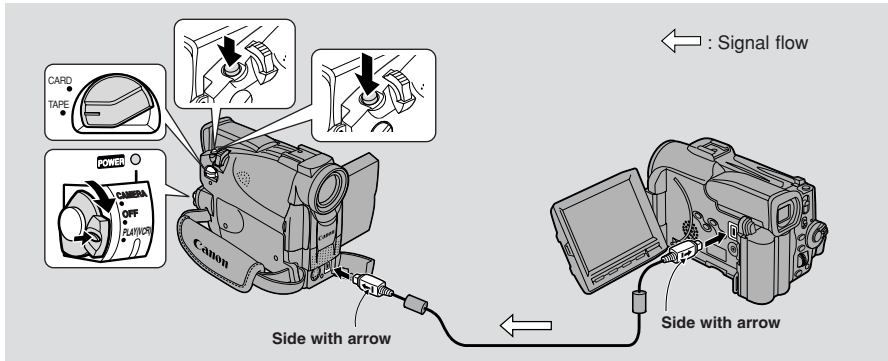

### Preparations

- 1. Connect the camcorder to the other digital device.**
  - Connect the Canon CV-150F DV cable (optional) with the sides of the plugs marked with the arrows facing as shown above.
- 2. Prepare the other device.**
  - Turn on the power and load a recorded cassette.
- 3. Load a memory card. Turn the camcorder's POWER switch to PLAY (VCR).**
- 4. Move the TAPE/CARD switch to TAPE.**
  - DV IN appears in the display.
  - If you have a cassette inserted, make sure it is in stop mode.

### Recording



- 1. Start playback on the other device.**
- 2. When the image you want to record appears in the display, press the PHOTO button halfway down and hold it.**
  - The image appears as a still image in the display.
  - The number of images that can still be recorded on the memory card appears in the display.
- 3. Press the PHOTO button fully down to record the image to the memory card.**



#### Note:

- If you record an image onto a memory card that was originally recorded in the 16:9 mode for widescreen TV's, the image will appear to be vertically "squashed" (compressed).



## Viewing Still Images



E

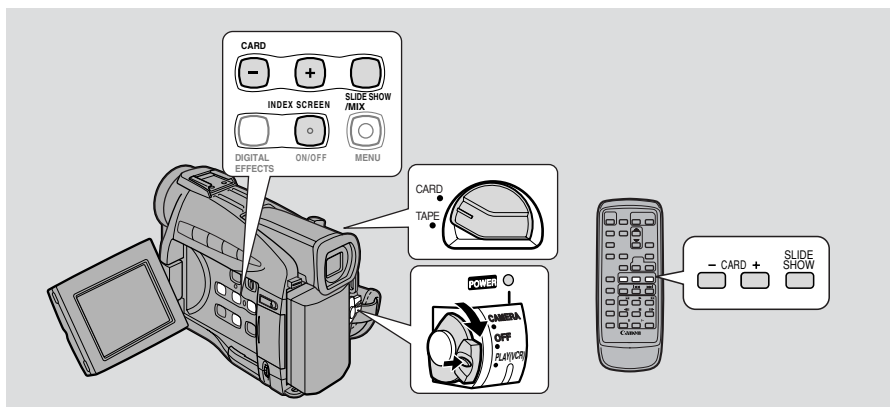

Play back and view still images recorded on a memory card. (For details on connecting to a TV, see “Connections for Playback on a TV Screen” on p. 31)

- The camcorder may not be able to copy or play, etc., images recorded on a non-Canon camcorder.

### Do not change the data recorded on a memory card.

- You may not be able to play back the following still images correctly on this camcorder:
  - Still images that have not been recorded with this camcorder but downloaded from a PC (excluding the sample images on p. 118-119)
  - Still images that have been recorded with this camcorder but have subsequently been enhanced on a PC
  - Still images whose image file names have been changed on a PC

### There are 3 ways to view still images:

- Single image
- Slide show: One after the other automatically in order of recording
- Index screen: Six images at once

Make sure a memory card that has images recorded on it is inserted into the camcorder.

### ● Single Image

1. Turn the **POWER** switch to **PLAY (VCR)**.
2. Move the **TAPE/CARD** switch to **CARD**.
  - The last image recorded appears in the display.
3. Search for the desired still image by pressing the **CARD +/-** buttons.
  - Press + to view the next image and – to view the previous image.
  - Pressing + at the last image will take you to the first image. Pressing – at the first image will take you to the last image.

## ● Slide Show

**With an image in the display, press the SLIDE SHOW button.**

- The images play back one after the other for 5 seconds each.

**To stop the slide show, press the SLIDE SHOW button.**

- The slide show starts or stops each time you press the SLIDE SHOW button.
- The slide show stops with the last image appearing in the display.

## ● Index Screen

Up to 6 images appear at once so you can search quickly for an image.

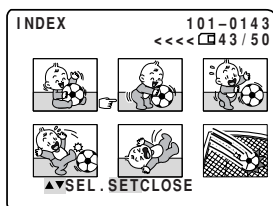

**1. With an image in the display, press the INDEX SCREEN button.**

- Up to 6 images appear in the display.

**2. Move the  mark to the image you want to view.**

- Turn the selector dial downwards to go to the previous image and upwards to go to the next image.
- Turning the dial upwards at the last image will take you to the next index screen. Turning the dial downwards at the first image will take you to the previous index screen.
- Jump to the next/previous index screen with the CARD +/- buttons.

**3. Press the selector dial in.**

- The image you have marked fills the whole display.



## Preventing Accidental Erasure (Protect)



E

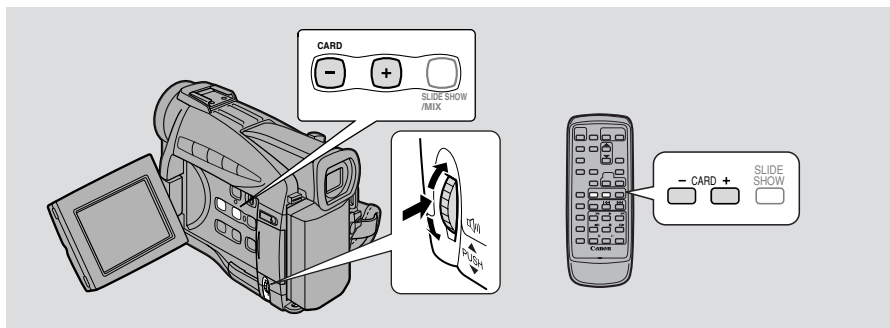

Select important images and protect them from accidental erasure. If a memory card is formatted, however, all images, including protected images, will be permanently erased ( 116).

- The pre-recorded sample images provided on the supplied MultiMediaCard are already protected.



### MENU

( 37)



Make sure a memory card that has images recorded on it is inserted into the camcorder.

1. **Open the menu and select CARD OPER.**
2. **Select PROTECT** .
  - Up to 6 images appear in the display.
3. **Move the mark to the image you want to protect.**
  - Turning the selector dial downwards takes you to the previous image and upwards takes you to the next image.
  - Turning the dial upwards at the last image will take you to the next index screen. Turning the dial downwards at the first image will take you to the previous index screen.
  - Jump to the next/previous index screen with the CARD +/- buttons.
4. **Press the selector dial in.**
  - The protect mark appears on the image.
  - Now you are unable to erase this image.
5. **Close the menu.**



### Note:

- To cancel image protection, move the mark to the protected image and press the selector dial in. The protect mark disappears.

## Erasing Still Images



E

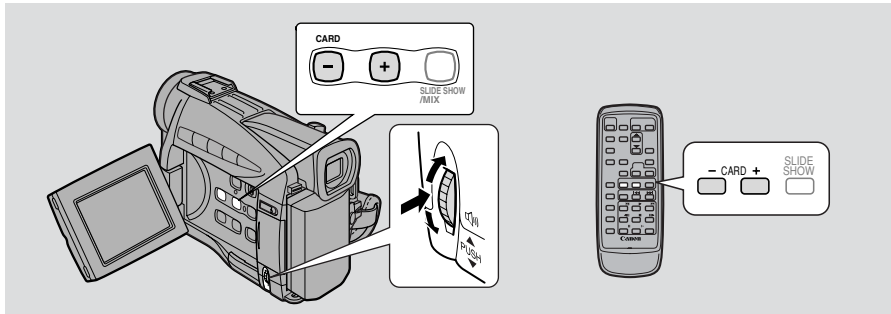

Erase images singly or all at once.

- You cannot erase protected images. Cancel image protection ( 107) first in order to erase an image.
- Erase images with caution. Once an image has been erased it cannot be restored.



**MENU**

( 37)



Make sure a memory card that has images recorded on it is inserted into the camcorder.

1. **Move to the image you want to erase with the CARD +/- buttons.**
  - Use the index screen ( 106) if necessary and make sure the image you want to erase fills the display.
2. **Open the menu and select CARD OPER.**
3. **Select IMAGE ERASE.**
  - CANCEL, SINGLE and ALL settings appear.
  - To cancel erasing, select CANCEL and close the menu.

To erase images one at a time

4. **Select SINGLE.**
  - ERASE THIS IMAGE? NO YES appears in the display.
5. **Select YES.**
  - The image erases and the previous image appears for erasing.
  - To erase another single image, move to that image with the CARD +/- buttons, and select YES.
  - If the image you are trying to erase is a protected image, YES appears in purple and is unselectable.
  - If you select NO, you return to step 4.
6. **Close the menu.**

To erase all images on the memory card at once



- 4. Select ALL.**
  - ERASE ALL IMAGES? [EXCEPT FOR  IMAGES] NO YES appears in the display.
- 5. Select YES.**
  - All images except the protected ones are erased.
  - If you select NO, you return to step 4.
- 6. Close the menu.**



## Combining Images and Recording Them to a Cassette (Card Mix)

E

Liven up your productions by superimposing one image on top of the other. Combine 2 still images or a still image and a moving image. Choose a still image from the memory card, either one of the pre-recorded sample images (  118) or one you have recorded yourself, then combine it with the currently recording image, moving or still.

Select from 3 types of Card Mix effects:

### **CARD CHROMA** (Card chroma key)

The currently recording image appears in place of the blue area of a pre-recorded still image such as a picture frame. When recording your own still image for overlapping, make sure to record the area in which you want the new image to appear blue, with a blue curtain as a background, for example. Adjust the mix level in the blue area of the pre-recorded image.

Image being recorded by the camcorder



+

Still image



→



### **CARD LUMI.** (Card luminance key)

The currently recording image appears in place of the light area of a still picture such as a handwritten illustration or title. Make your own by drawing or writing on a white piece of paper. Adjust the mix level in the light area of the still image.

Image being recorded by the camcorder



+

Still image



→



### CAM. CHROMA (Camera chroma key)

Superimpose the currently recording image on top of a still image, which becomes its background. Shoot the subject of the currently recording image against a blue background, such as a blue curtain. The original still image will appear in place of the blue area. Adjust the mix level in the blue area.



### Mix level

The mix level bar appears. Adjust the mix level using the – and + at the ends of the bar as guides.

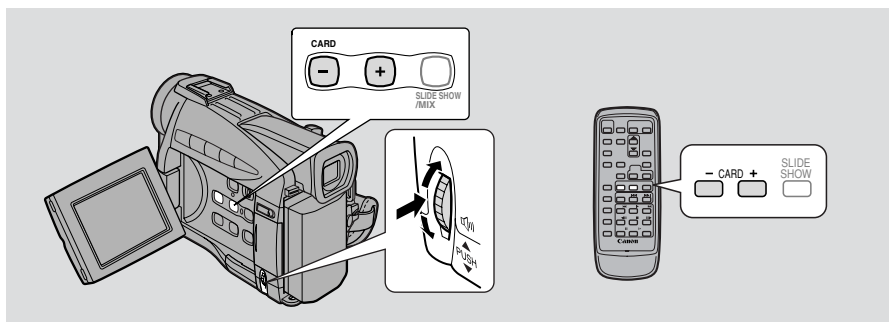

**TAPE** + **CAMERA**

**MENU**  
( 37)

▶▶CARD MIX

▶MIX TYPE...CARD CHROMA

▶MIX LEVEL... ———▶

Make sure a memory card that has images recorded on it and a cassette have been inserted into the camcorder.

Make sure the program selector is set to **P**.

Select

1. Open the menu and select **▶▶CARD MIX**.
2. Press the **CARD +/-** buttons to select the still image to be combined.
3. Select **MIX TYPE**.
  - **CARD CHROMA**, **CARD LUMI.**, **CAM. CHROMA** settings appear.

**E****4. Select the desired setting.**

- Your currently recording image is combined with the pre-recorded still image.

**5. Select MIX LEVEL.****6. Adjust the mix level.**

- Turning the selector dial upwards adjusts to the right and turning downwards adjusts to the left.

**7. Close the menu.**

- CARD MIX flashes in the display.

On/Off

**8. Press the card MIX button.**

- CARD MIX stops flashing.
- Your currently recording image is combined with the pre-recorded still image.
- Each time you press the card MIX button, your selection is activated (display lights continuously) or deactivated (display flashes).

For a moving image

**1. Press the start/stop button to start and stop recording.**

- The combined images are recorded onto the cassette.

For a still image

**1. Press the PHOTO button halfway down and hold it.**

- ● flashes white in the display as the camcorder adjusts the focus and it is displayed continuously as a green mark when the camcorder is ready to take the image.

**2. Press the PHOTO button fully down to record the image to the cassette.**

- ● disappears from the display.
- The combined images are recorded onto the cassette for approximately 6 seconds (8 seconds in the **SP** or **LP** recording mode).

**Notes:**

- If you change the position of the POWER switch or move the program selector from **P** to **□** Easy Recording mode, select your still image for Card Mix again.
- When setting Card Mix, you must carry out steps 1 to 4.



## Copying Still Images from a Cassette



E

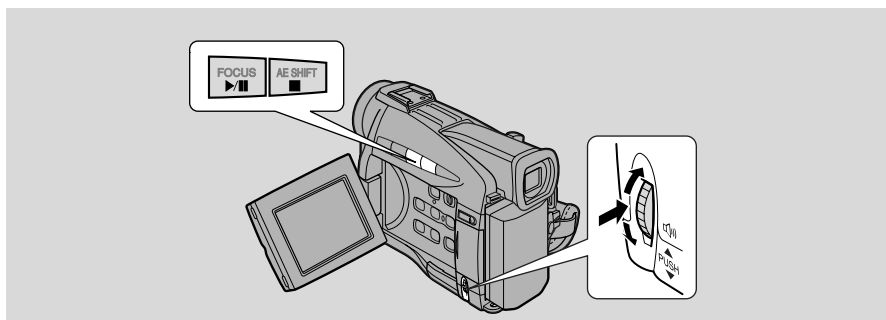

Copies multiple still images from a tape to the memory card, using the Photo Search function.

- The still images' data codes will reflect the date and time the copies are made.



**MENU**

( 37)

▶CARD OPER.

▶COPY [ ]

Make sure a memory card that has enough memory available and a recorded cassette have been inserted into the camcorder.

- 1. Locate the first still image on the cassette that you want to copy and stop the cassette at a point before that image.**
  - All the still images on the cassette after that point will be copied onto the memory card.
  - If you want to copy all the images on a cassette, rewind the cassette to the beginning.
- 2. Open the menu and select CARD OPER.**
- 3. Select COPY [ ].**
  - CANCEL and EXECUTE settings appear.
- 4. Select EXECUTE.**
  - Select CANCEL to stop copying.
  - Cassette and card information appear in the display and copying starts.
  - NOW COPYING [ ] appears in the display.
  - The camcorder automatically performs the Photo Search function to locate still images and copying starts. The currently copying image appears in the display.
  - Copying stops when the cassette is finished or the memory card is full. When the memory card is full, CARD FULL will appear in the display.
- 5. Press the stop button when your desired images have finished copying.**

## Copying Memory Card Still Images to a Cassette



E

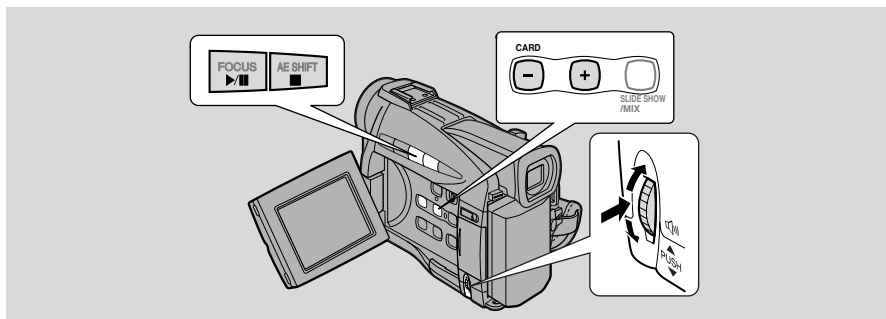

Copies multiple still images from the memory card to a cassette.

- The still images' data codes will reflect the date and time the copies are made.
- The **[ ]SP** and **[ ]LP** recording modes are not available when copying memory card images to a cassette.

### MENU

( [ ] 37)

▶CARD OPER.

▶COPY [ [ ] → [ ] ]

Make sure a memory card that has images recorded on it and a cassette that has enough recordable space have been inserted into the camcorder.

**TAPE** + **PLAY (VCR)**

1. Locate the point on the cassette where you want to start copying and set it to stop.

**CARD** + **PLAY (VCR)**

2. Select the first image you want to copy by using the **CARD +/-** buttons.
  - Still images on the memory card including and after that image will be copied onto the cassette.
  - If you want to copy all the still images on the memory card, select the first image.
3. Open the menu and select **CARD OPER.**
4. Select **COPY [ [ ] → [ ] ]**.
  - CANCEL and EXECUTE settings appear.
5. Select **EXECUTE**.
  - Select CANCEL to stop copying.
  - Cassette and card information appear in the display and copying starts.
  - NOW COPYING [ [ ] → [ ] ] appears in the display.
  - Each image is copied for about 6 seconds on the cassette.
  - Copying stops when all the images have been copied or the tape is full.
6. Press the stop button when your desired images have finished copying.

## Marking a Still Image for Printing (Print Mark)



E

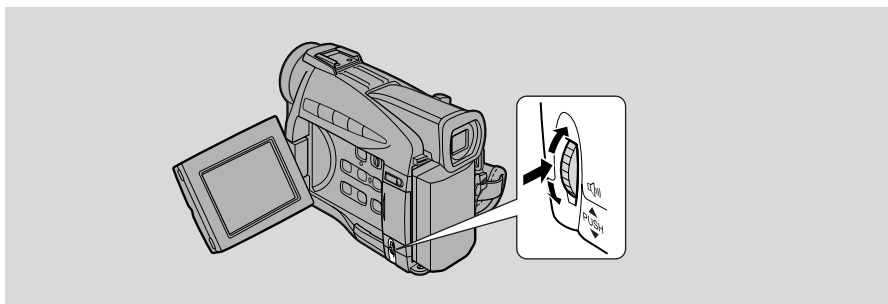

An image on a memory card must be marked before it can be printed. The camcorder supports the  DPOF (Digital Print Order Format) print format. Images can be automatically printed on a DPOF-supporting Canon printer. Up to 50 images per memory card can be print marked.





**MENU**

(  37)



▶ CARD OPER.

▶▶ PRINT MARK 

Make sure a memory card that has images recorded on it has been inserted into the camcorder.

1. **Open the menu and select CARD OPER.**
2. **Select PRINT MARK .**
  - Up to 6 images appear in the display.
3. **Move  to the image you want to mark.**
  - Turning the selector dial downwards takes you to the previous image and upwards takes you to the next image.
  - Turning the dial upwards at the last image will take you to the next image. Turning the dial downwards at the first image will take you to the previous image.
  - Jump to the next/previous index screen with the CARD +/- buttons.
4. **Press the selector dial in.**
  - The  print mark appears next to the image.
5. **Close the menu.**

### **Notes:**

- To cancel a print mark, move  to the print-marked image and press the selector dial in. The  print mark disappears.
- If there are a large number of images recorded on the memory card, it may take time for a print mark to appear on an image.

## Formatting a Memory Card



E

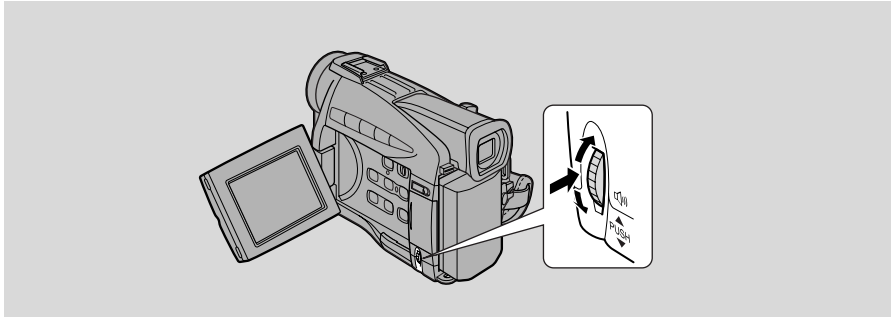

Format new memory cards, if you get the message **CARD ERROR**, or to permanently and quickly erase all the images on a memory card, including protected images (this includes the pre-recorded card mix sample images). The MultiMediaCard supplied with this camcorder has already been formatted for you.

- Be cautious when formatting recorded memory cards. All images will be permanently erased.
- If you purchase additional memory cards, format them with the camcorder, not a PC or other device.



**MENU**  
( 37)



Make sure a memory card is inserted into the camcorder.

1. **Open the menu and select **CARD OPER.****
2. **Select **FORMAT.****
  - **CANCEL** and **EXECUTE** settings appear.
3. **Select **EXECUTE.****
  - Select **CANCEL** to cancel formatting.
  - **FORMAT THIS CARD? NO YES** appears to confirm.
4. **Select **YES.****
  - Formatting starts and **NOW FORMATTING** appears in the display.
  - If you select **NO**, you return to step 3.
5. **Close the menu.**

Using a Memory Card

## Other Information and Precautions

E

The camcorder formats memory cards in DCF (Design rule for Camera File system).

Images recorded on a memory card with this camcorder can be transferred to a PC with the use of the following products made for MultiMediaCards or SD Memory Cards:

**PC Card Adapter:** Holds a memory card then inserts into the PC card slot found on most types of laptop PCs.

**PC Card Reader:** Connects to a PC, then accepts a memory card.

**FD Adapter:** Holds a MultiMediaCard then inserts into a PC's floppy disk drive.

If you need extra MultiMediaCards in addition to the supplied one, use cards made by SanDisk Corporation.

If you mistakenly erase the card mix sample images provided on the MultiMediaCard, they can be downloaded from the following home page:\*

<http://www.canondv.com>

\* You will need a PC Card Adapter or PC Card Reader to be able to download to a memory card.

### Memory card operating precautions

- If you purchase additional memory cards, format them with the camcorder, not a PC or other device. There have been cases where memory cards formatted with a PC or other device do not function properly.
- We recommend saving backups of memory card images on your PC's hard drive or other external memory device. Image data may be damaged or lost due to a defect in a memory card, or if a memory card is exposed to static electricity. Contents of a memory card cannot be compensated for should data become damaged or lost.
- Do not remove the power source or the memory card while the camcorder is accessing (recording to, reading, erasing files from or formatting) the memory card.
- Do not use memory cards in places subject to strong magnetic fields.
- Do not disassemble memory cards.
- Do not bend or drop memory cards, or expose them to strong vibrations or external shocks.
- Do not get memory cards wet.
- Do not remove the memory card's label or affix other labels. Affix labels to the memory card's case.

**E**

- Do not leave memory cards in places subject to high temperature or high humidity.
- Moving a memory card rapidly between hot and cold temperatures may cause condensation to form on it, leading to malfunctions. Avoid this problem by placing the memory card in a plastic bag and letting it slowly adjust to temperature changes before removing it from the bag. If condensation should occur, maintain the memory card at a constant temperature and let the moisture evaporate naturally.
- Do not touch the memory card's terminals or let dust or dirt come in contact with the terminals. Store and carry memory cards in their case to protect the terminal area.
- There is only one correct way to insert memory cards into the camcorder. Do not forcefully insert the memory cards backwards or upside down. This could damage the memory card or the camcorder.

**Sample images**

The following are the sample images that have been pre-recorded on the included MultiMediaCard. There are a total of 15 images: 8 Card chroma key images, 5 Card luminance key images and 2 Camera chroma key images.

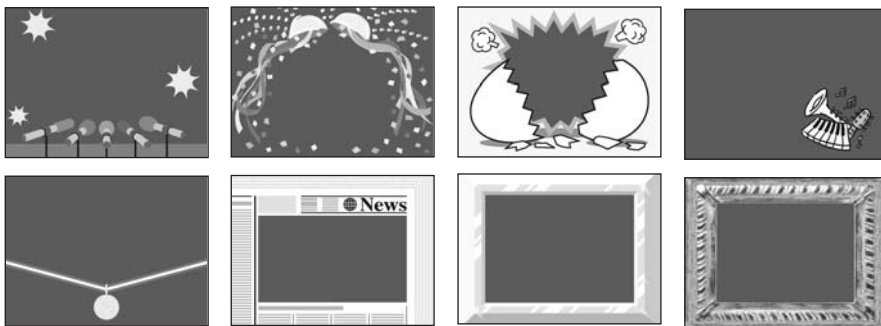
**Card chroma key**

### Card luminance key

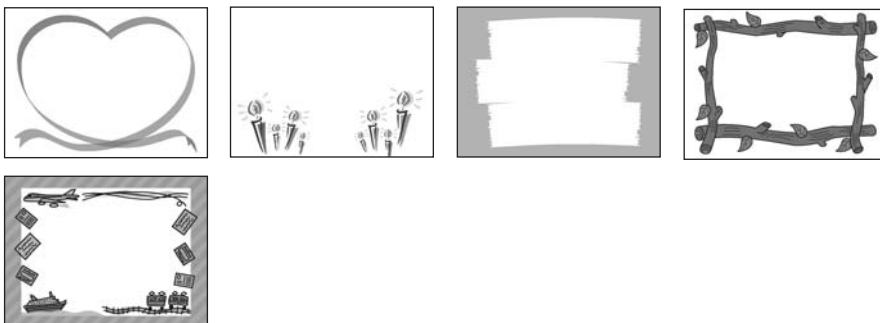

### Camera chroma key

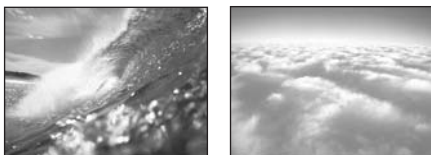

- The pre-recorded sample images on the MultiMediaCard included with this camcorder are intended solely for the personal enjoyment gained from combining them with personal videos taken with this camcorder. Do not use the pre-recorded sample images for any other purpose.

### PhotoEssentials - Royalty Free Stock Photography

The PhotoEssentials suite of royalty-free images on CD-ROM features premium quality assignment photography and is ideally suited for use in advertising, brochures, reports, multimedia, websites, books, packaging and more.

For more information, please visit their website [www.photoessentials.com](http://www.photoessentials.com)

### MultiMediaCard MMC-8M Specifications

<b>Capacity</b>	8 MB
<b>Interface</b>	MultiMediaCard standard
<b>Operating temperature range</b>	32°F–140°F (0°C–40°C)
<b>Dimensions</b>	32 × 24 × 1.4 mm
<b>Weight</b>	1.5 g

Weight and dimensions are approximate  
Errors and omissions excepted.  
Subject to change without notice.

## Preparing the Camcorder

E

### Adjust the viewfinder

- Set the camcorder to TAPE CAMERA mode. Extend the viewfinder straight out, then adjust the viewfinder focusing lever to suit your eyesight.
- Rotate the viewfinder to an angle that allows you to view comfortably. Store the camcorder with the viewfinder flush with the body of the camcorder.
- To view with the viewfinder, make sure the LCD panel is either turned so that the subject can monitor viewing, or totally closed with the screen facing inwards.

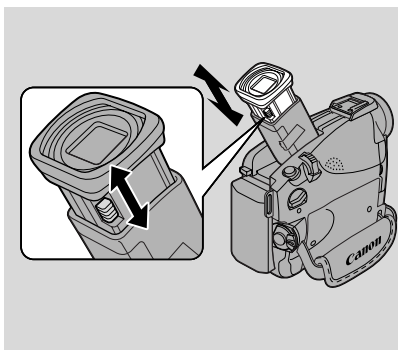

### Prepare the lens cap

- Attach the cord to the lens cap, and pass the grip belt through the loop on the cord.
- Hook the lens cap on to the grip belt while you are recording, and place it over the lens when you have finished.

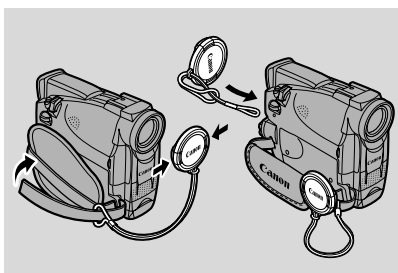

### Fasten the grip belt

- Release the Velcro fastening and hold the camcorder with your right hand while you adjust the belt with your left. Your index finger should reach the zoom control and photo button, and your thumb should reach the start/stop button comfortably.

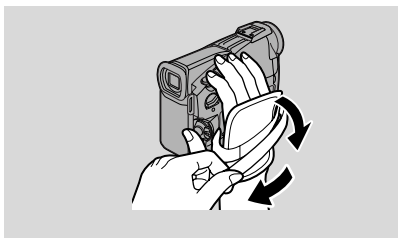

Additional  
Information



### Attach the shoulder strap

- For extra security and portability, attach the shoulder strap before using the camcorder.
- Pass the ends through the attachment bars and adjust the length as shown.

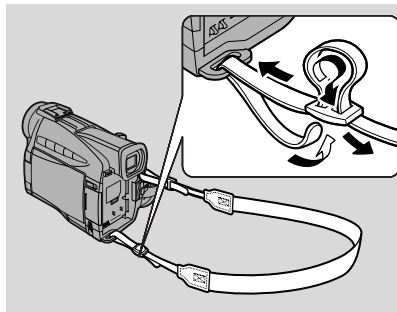

Be careful not to leave the viewfinder exposed to bright sunlight, or it will melt. (The light is concentrated by the viewfinder lens.) Adjust the angle of the viewfinder to prevent sunlight from entering.

## Notes on Using the Batteries

E

### Charging and recording times

- These times vary — the safest policy is always to have 2 or 3 times as many battery packs as you think you will need.
- You will get more recording time if you turn the camcorder off between shots, instead of leaving it in record pause mode.

	Time needed for full recharge	Maximum recording time	
		Using viewfinder	Using LCD screen
BP-512	1 hr. 10 min.	2 hr. 30 min.	2 hr.
BP-511 (optional)	1 hr. 10 min.	2 hr. 30 min.	2 hr.
BP-522 (optional)	2 hr.	5 hr. 10 min.	4 hr. 15 min.
BP-535 (optional)	2 hr. 50 min.	8 hr. 15 min.	6 hr. 45 min.

- Recording time will be shorter than usual at low temperatures. You can use the battery pack between 32° and 104°F (0° to 40°C), but it works best between 50° and 86°F (10° to 30°C).
- If the battery pack starts to give you much less recording time than usual, it has reached the end of its life and must be replaced.

 **Note:**

- These figures show how long you can view playback with the LCD, after attaching a fully-charged battery pack. Playback time will be shortened at low temperatures.

Battery pack	Playback time (using the LCD screen)
BP-512	2 hr. 15 min.
BP-511 (optional)	2 hr. 15 min.
BP-522 (optional)	4 hr. 45 min.
BP-535 (optional)	7 hr. 40 min.

## How much power is left?

The indicator in the display shows you approximately how much charge the battery pack has left:



### Notes:

- “CHANGE THE BATTERY PACK” appears in the display for 4 seconds when the power is completely exhausted. The empty battery mark then appears and starts to flash. The power indicator light also flashes.
- The indicator is not constant — different levels will be shown when you subject the battery pack and camcorder to different conditions.

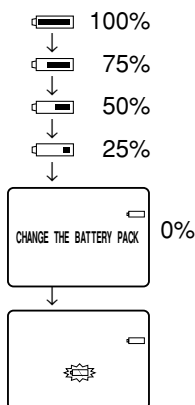

## When to recharge

You can recharge a lithium ion battery pack whenever it is convenient. Unlike a conventional battery pack, it does not have to be fully discharged first. However, as the battery pack will naturally discharge itself over time, it is best to charge it the same day you plan to use it, or the day before.

## Taking care of the battery pack

### Always attach the terminal cover.

- Do not allow any metal objects to touch the terminals, as this can cause a short circuit and damage the battery pack. Attach the terminal cover whenever the battery pack is not being used.

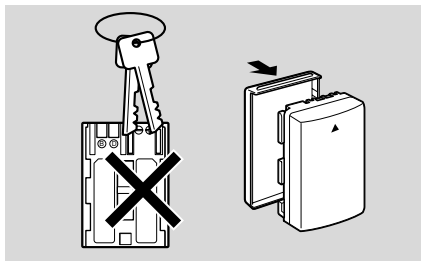

### Keep the terminals clean.

- The camcorder adapter or battery pack will not work properly if the terminal are dirty. Attach the terminal cover whenever the battery pack is not being used.

### Storing the battery pack

- If you do not use a battery pack for a period of more than a few months any remaining charge may cause damage to the battery pack, and reduce usage time. To prevent damage therefore, aim to use a battery pack's complete charge before storage. See the optional battery pack's instructions for further details.

**E****Installing the backup battery**

Open the backup battery cover on the battery attachment unit, and insert the CR2025 lithium battery with the + side facing outwards. Click the cover back into place.

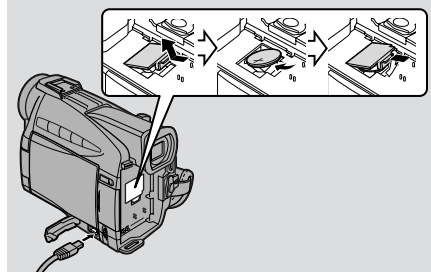

This backup battery allows the camcorder to remember the date and time and other settings when main power source is removed. It has a life span of about a year.

When it needs replacing (or if it has not been installed), the  mark flashes in the display. Remove the old battery by pushing up then releasing and lifting out. Make sure to attach a power source to the camcorder first, so it will remember your chosen settings when you change the battery.

**DANGER!****Treat the battery pack with care.**

- Keep it away from fire (or it might explode).
- Do not expose the battery pack to temperatures greater than 140°F (60°C). Do not leave it near a heater, or inside a car in hot weather, for example.
- Do not try to disassemble or modify it.
- Do not drop or knock it.
- Do not get it wet.

**WARNING!**

- The battery used in this device may present a fire or chemical burn hazard if mistreated. Do not recharge, disassemble, heat above 212°F (100°C) or incinerate.
- Replace the battery with a Sony, Hitachi Maxell, Sanyo or Panasonic CR2025, or Duracell DL2025. Use of another battery may present a risk of fire or explosion.

**Additional Information****Cautions:**

- Do not pick up the battery using tweezers or other metal tools — this will cause a short circuit.
- Wipe the battery with a clean, dry cloth to ensure proper contact.
- Keep the battery pack out of reach of children — if it is swallowed, contact a physician immediately, as the battery case may break down and the battery fluids damage the stomach and intestines.
- Do not disassemble, heat or immerse the battery in water, to avoid the risk of explosion.

## Maintenance

### Cautions

E

#### **Avoid high temperatures and high humidity.**

- Do not leave the camcorder inside a car in hot weather, for example.
- Be careful of heat radiating from video lighting equipment.
- Do not take the camcorder into a humid room.

#### **Avoid sudden changes in temperature.**

- If you take the camcorder from a cold place to a warm place, condensation may form on the lens and internal parts (  128).

#### **Do not point the lens or viewfinder at strong light sources.**

- Never point it at the sun, and do not leave it aimed at a bright subject.
- Be especially careful when leaving the camcorder on a tripod.

#### **Avoid magnetic or electric fields.**

- Do not use the camcorder close to TV transmitters, portable communication devices or other sources of electric or magnetic radiation. They may cause picture interference, or permanently damage the camcorder.

#### **Do not expose the camcorder to water.**

- Cover the camcorder when you are recording in rain or mist.
- There is a risk of electric shock if water gets inside the camcorder — contact qualified service personnel as soon as possible.

#### **Protect the lens.**

- Sand and dust can damage the lens — be especially careful on windy days.

#### **Handle the camcorder gently.**

- Vibration or shock can cause damage.
- Do not use the viewfinder or LCD panel as a carrying handle.

#### **Do not disassemble the camcorder.**

- This is very dangerous as there is a risk of electric shock — if the camcorder does not function properly, take it to qualified service personnel.

## E

### Storage

If you do not intend to use the camcorder for some time, store it in an area which is free of dust and moisture, and where the temperature is no higher than 86°F (30°C). After storage, check each part and function of your camcorder to make sure everything is still working properly.



#### Note:

- These cautions also apply to accessories such as battery packs and cassettes.

### Maintenance

#### Viewfinder

- Clean the viewfinder screen. Rotate the viewfinder upwards. Remove the viewfinder protect cover and clean by inserting a cotton swab. When finished, return it flush with the camcorder.
- The viewfinder screen scratches easily. Take care when cleaning.

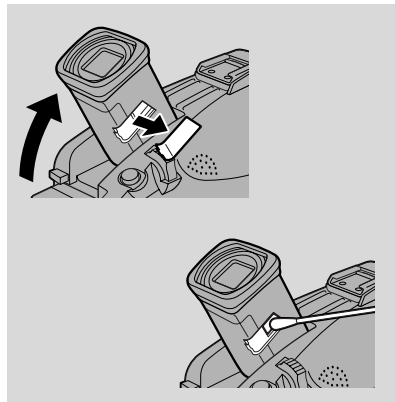

#### LCD

- Clean the LCD screen using a commercially available cleaning cloth for glasses.
- Where there is a big change in temperature, moisture may form on the surface of the screen. Wipe clean with a soft, dry cloth.
- At low temperatures the display may appear to be much darker than usual. This is not a fault, and as the screen warms up the display will return to normal.

#### Camcorder body and lens

- Use a soft, dry cloth to clean the camcorder body or lens. Never use chemically treated cloth or volatile solvents such as paint thinner.

### Video heads

- When mosaic-like noise appears on the playback picture, the video heads may be dirty. When the video heads are badly contaminated, the camcorder may show a blank blue screen or a warning.
- For the best picture possible, after using the camcorder for approximately 20 hours, clean the video heads using Canon's DVM-CL Digital Video Head Cleaning Cassette. If the "noise" remains, repeat the cleaning (up to maximum of 5 times).
- Do not use a wet-type cleaning cassette, as this can cause damage.



## Using the camcorder abroad

### Power sources

- You can use the compact power adapter to operate your camcorder and charge battery packs in any country where the electricity supply is between 100 and 240 V AC, 50/60 Hz. Contact your Canon dealer for information about plug adapters for overseas use.

### TV playback

- Although you can always play back your recordings on the LCD screen, your camcorder can only be connected to TVs which use its NTSC system. This TV system is used in the following countries:  
American Samoa, Bahama, Barbados, Bermuda, Bolivia, Canada, Chile, Columbia, Costa Rica, Cuba, Ecuador, El Salvador, Guam, Guatemala, Greenland, Haiti, Honduras, Jamaica, Japan, Korea, Mexico, Micronesia, Myanmar, Nicaragua, Panama, Peru, Philippines, Puerto Rico, Saint Lucia, Surinam, Taiwan, Trinidad and Tobago, USA, Venezuela.

## Condensation

Condensation may form on the camcorder when it is moved from a cold place to a warm place. Using the camcorder while condensation is present can damage both the tape and the camcorder.

Condensation may become a problem:

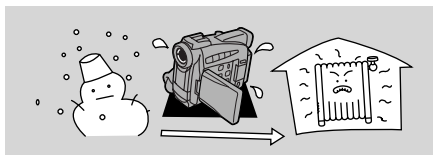

When you take the camcorder from a cold place to a warm room

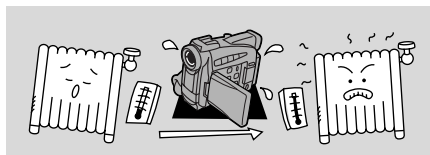

When a cold room is heated rapidly

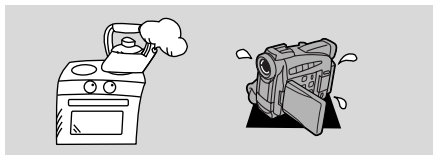

When the camcorder is left in a humid room

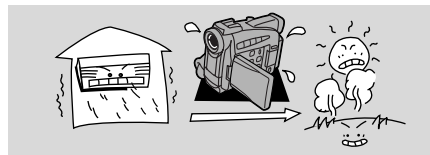



When the camcorder is taken from an air-conditioned room to a warm, humid place

### Protecting the camcorder from condensation

- Before you take the camcorder to a warm or humid place where condensation is likely to be a problem, unload the cassette and put the camcorder in a plastic bag. Wait until the camcorder reaches room temperature before you take it out of the bag.

### What happens when condensation is detected

- “CONDENSATION HAS BEEN DETECTED” is displayed for approximately four seconds. Then, the power indicator flashes and the  mark flashes in the display. If there is a cassette in the camcorder, it stops automatically and “REMOVE THE CASSETTE” is displayed for approximately 4 seconds and then  flashes in the display. If you have the beep turned on, it will sound.
- The camcorder may not detect the condensation immediately — the condensation warning may not start flashing for 10 to 15 minutes.
- You cannot load a cassette when condensation is detected.

### What you should do

- Remove the cassette, leave the cassette compartment open, and turn the camcorder off.
- Leave it in a dry place until the condensation evaporates. After the condensation warning stops flashing, wait at least another hour before trying to use the camcorder.



## Troubleshooting

Refer to this checklist first if you have any problems with your camcorder. Possible explanations are given for each problem on the list — turn to the page numbers in parentheses for more information.

E

Make sure that the camcorder is properly connected if you are using it with a TV or VCR. Consult your dealer or service outlet if problems persist.

### Recording/Playback

#### Problem

❑ **Nothing happens when I press the buttons.**

❑ **The camcorder turned itself off.**

❑ **The cassette compartment stopped mid-operation while loading/unloading a cassette.**

❑ **The start/stop button doesn't work.**

❑ **There's no picture in the display.**

❑ **There's a blank blue screen in the display.**

❑ **The camcorder won't focus.**

#### Cause and/or what to do about it

- The camcorder is not set to the appropriate mode ( 19, 27).
- The cassette is not loaded or is set for erasure prevention ( 17-18).
- The cassette has reached the end.
- The power source is not properly connected, or the battery pack is exhausted or not properly attached ( 12-16, 123).
- The function cannot be used in that recording program ( 55).
- The camcorder was in record pause mode for more than about 5 minutes ( 19, 101).
- The battery pack is exhausted ( 13-16, 123).
- The battery pack's power is exhausted. Recharge or change to a new battery pack ( 13-16).
- The cassette is not loaded or is set for erasure prevention ( 17-18).
- The cassette has reached the end.
- The camcorder is not set to the appropriate mode ( 19,27).
- You are attempting to play back or record copyright protected material ( 85).
- The video heads are badly contaminated ( 127).
- The camcorder is on manual focus ( 75).
- The viewfinder lens needs adjusting ( 120).
- The lens is dirty ( 126).

**E**

 **Note:**

- Some subjects are not suitable for autofocus. In these situations, you will often get better results using manual focus ( 75). Focus on something which is about the same distance away, lock the focus, and then point the camcorder at your original, hard-to-focus subject.

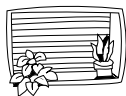

Horizontal stripes



Many subjects at different distances



Behind glass

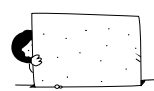

Without much contrast (e.g. a white wall)



Reflective surfaces (e.g. shiny car surfaces)



Fast moving objects



Dark subjects



Night scenes

**Recording/Playback (Cont.)**

**Problem**

- ❗ **Some/all of the digital effects don't work.**
- ❗ **The ► (play) button doesn't work.**
- ❗ **There's a bright stripe on the screen.**



- ❗ **The playback picture is rough (with mosaic-like noise).**
- ❗ **There's no picture on the TV screen, even though the tape is moving.**

**Cause and/or what to do about it**

- There are a number of restrictions on using the digital effects. ( 59-65).
- The camcorder is not set to TAPE PLAY (VCR) mode ( 27).
- The cassette is not loaded ( 17).
- The cassette has reached the end.
- When recording in dark places a bright light in the scene may cause a vertical light bar ("smear") to appear. This is a normal feature of camcorders.
- The video heads need cleaning ( 127).
- The video heads need cleaning ( 127).
- The TV/VIDEO selector on the TV isn't set to VIDEO ( 32-33).

**?** There's no sound coming from the speaker during playback.

- The speaker has been turned off with the selector dial ( 130 ).
- Headphones are being used.

**E**

## Memory card operations

### Problem

**?** The memory card will not insert.

**?** The  mark flashes red in the display even though a memory card has been inserted.

**?** Nothing happens when I press the buttons.

### Cause and/or what to do about it

- It is not turned the right way ( 198 ). Turn it the right way and try inserting again.
- Turn the camcorder's power off and back on again and remove and reinsert the card if necessary.
- The camcorder is not set to CARD CAMERA or CARD PLAY (VCR) mode ( 101, 105 ).
- The memory card is not inserted ( 98 ).
- You are using an SD Memory Card and it is set for erasure prevention. Change the position of the protect switch.
- The memory card is full. Erase images ( 108 ) or insert a new memory card.
- The power source is not properly connected ( 12 ), or the battery pack is exhausted or not properly attached ( 13, 123 ).
- The function cannot be used in that recording program ( 55 ).
- The memory card is not loaded ( 98 ).
- You are using an SD Memory Card and it is set for erasure prevention. Change the position of the protect switch.
- The memory card is full. Erase images ( 108 ) or insert a new memory card.
- You have reached the maximum file number. Set the file numbering to RESET through the menu ( 100 ) and insert a new memory card.
- You are using an unformatted memory card. Format the card ( 116 ).

**?** The PHOTO button doesn't work.

**E**

**?** The image cannot be erased.

- The image is protected (  107).
- You are using an SD Memory Card and it is set for erasure prevention. Change the position of the protect switch.

## Miscellaneous

### Problem

**?** The wireless controller doesn't work.





**?** The power indicator is flashing.

**?** The camcorder malfunctions.

**?** The DV cable is connected correctly, but there's nothing in the display.

**?** The camcorder becomes warm during use.

### Cause and/or what to do about it

- The remote sensor mode is set to OFF (  ) in the menu (  46).
- The remote sensor modes of the wireless controller and the camcorder itself are different (  46).
- The batteries are dead or not inserted.
- Check the screen displays (  137).
- External interference may cause the camcorder's microprocessor to malfunction temporarily. If random letters appear in the display or if normal operation is interrupted, remove and then replace the power source.
- Remove the cable and then reconnect it or turn the power off and back on again.
- This is not a malfunction.

# The ZR30 MC System Diagram (Availability differs from area to area)

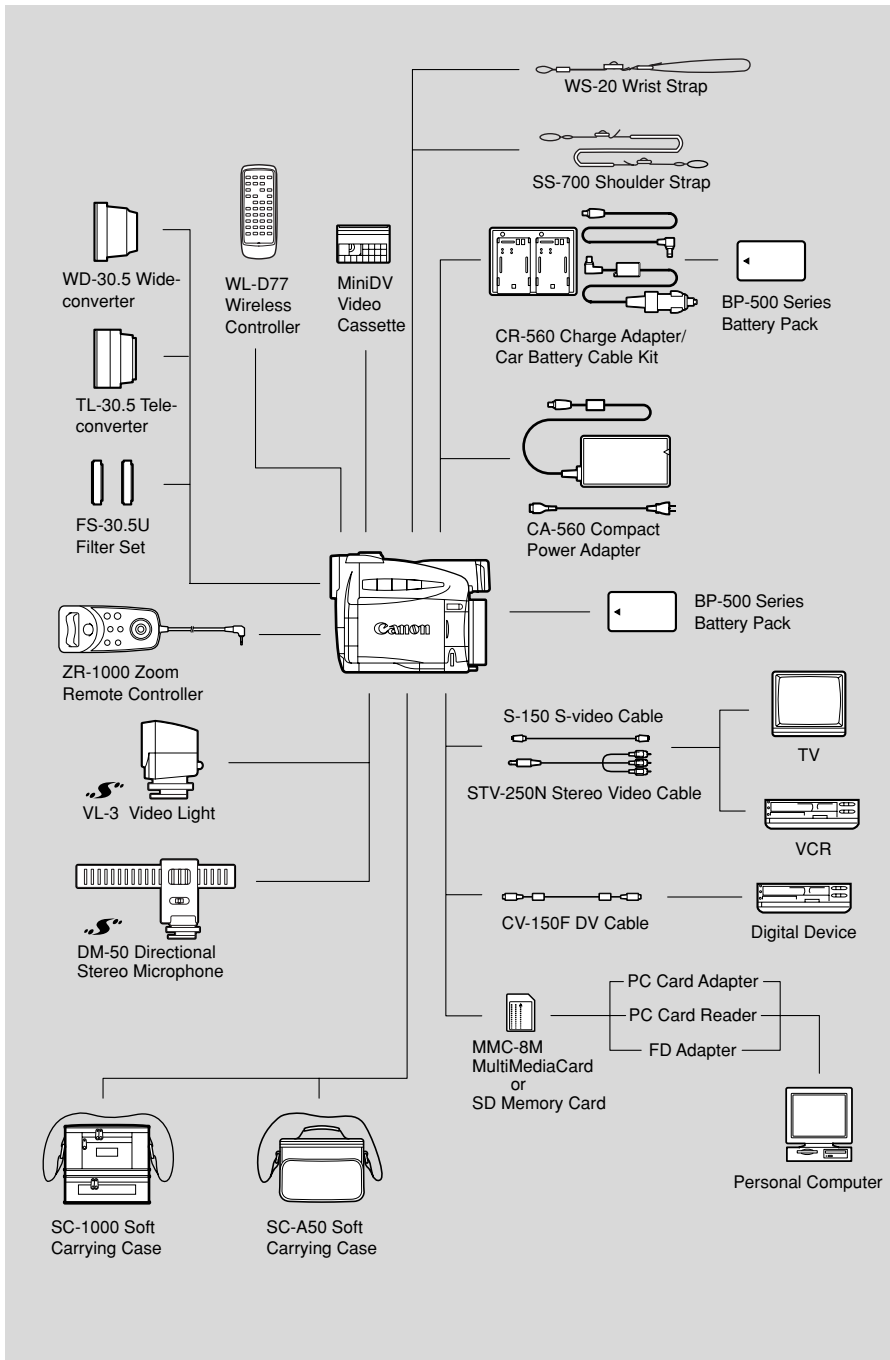

E

Additional Information

## Optional Accessories

E

Call or visit your local retailer/dealer for genuine Canon video accessories. You can also obtain genuine accessories for your Canon camcorder by calling: 1-800-828-4040, Canon U.S.A. Information Center.

### BP-500 Series Battery Packs

Extra batteries for use with the ZR30 MC.

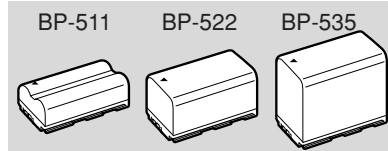

### CR-560 Charge Adapter/Car Battery Cable Kit

Connect the car battery cable to power your camcorder or recharge battery packs on the move. The car battery cable plugs into your car's cigarette lighter socket and runs off a 12-24 V DC negative ground battery.

Also, when used with the CA-560 Compact Power Adapter, this charge adapter can charge the BP-500 series lithium ion battery packs from an AC outlet.

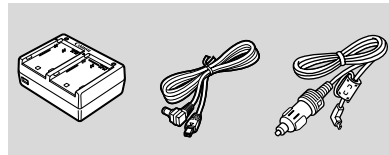

### TL-30.5 Tele-converter

This tele-converter lens increases the focal length of the camcorder lens by a factor of 1.9.

- The image stabilizer is not as effective as usual when the tele-converter is attached.

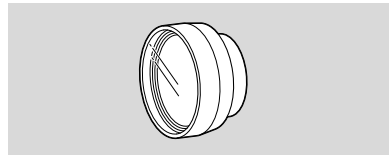

### WD-30.5 Wide-converter

This lens decreases focal length by a factor of 0.7, giving you a wide perspective for indoor shots or panoramic views.

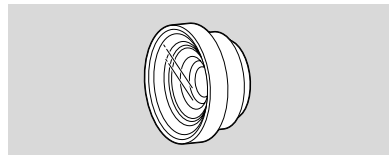

Additional  
Information

### **FS-30.5U Filter Set**

Neutral density and MC protector filters to help you take control of difficult lighting conditions.

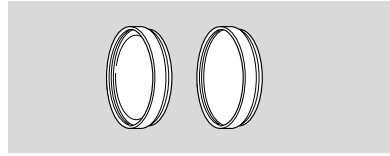

**E**

### **VL-3 Video Light**

Attach the Video Light to a camcorder when recording in dark rooms. When on its automatic setting, the Video Light turns on/off automatically according to the brightness level of shooting conditions.

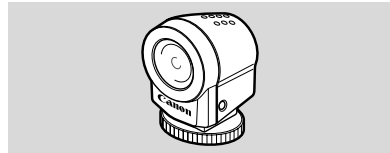

### **DM-50 Directional Stereo Microphone**

This highly sensitive, super-directional microphone attaches to a camcorder's advanced accessory shoe. It is a highly sensitive microphone that can be switched between functioning as a directional microphone (monaural) or a stereo microphone that also clearly picks up sounds arriving from the front of the microphone, for full recorded sound.

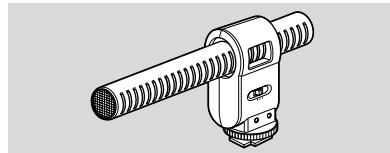

### **Zoom Remote Controller ZR-1000**

When this product is plugged into the LANC  terminal of a Canon camcorder, it is possible to control functions such as the start and stop of recording and the zoom and focusing functions while the camcorder is mounted on a tripod, without touching the camcorder body itself.

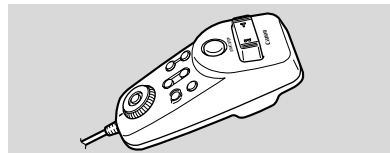

### **WS-20 Wrist Strap**

Provides an extra measure of protection for active shooting.

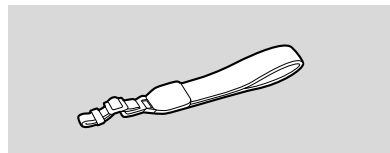

**Additional  
Information**

**E****SC-1000 Soft Carrying Case**

A handy camcorder bag with padded compartments and plenty of space for accessories.

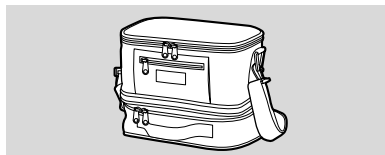
**SC-A50 Soft Carrying Case**

This lightweight bag keeps the camcorder within easy reach without weighing you down or getting in the way. Genuine leather.



This mark identifies genuine Canon video accessories. When you use Canon video equipment, we recommend Canon-brand accessories or products bearing the same mark.

**Provided accessories:**

WL-D77 Wireless Controller	D83-0582-000
CA-560 Compact Power Adapter	D85-1100-003
BP-512 Battery Pack	D85-1312-000
SS-700 Shoulder Strap	D81-1390-000
S-150 S-video Cable	D82-0330-000
STV-250N Stereo Video Cable	D82-0590-000
Lens cap	D52-0100-000

**Optional accessories:**

CR-560 Charge Adapter/ Car Battery Cable Kit	D85-0680-201
BP-511 Battery Pack	D85-1112-201
BP-522 Battery Pack	D85-1122-201
BP-535 Battery Pack	6741A002AA
SC-1000 Soft Carrying Case	D81-1200-201
SC-A50 Soft Carrying Case	D81-1302-201
WD-30.5 Wide-converter	6739A001AA
TL-30.5 Tele-converter	6740A001AA
FS-30.5U Filter Set	6738A001AA
VL-3 Video Light	D86-0121-201
DM-50 Directional Stereo Microphone	D84-0120-201
ZR-1000 Zoom Remote Controller	D83-0540-201
WS-20 Wrist Strap	D81-0190-202
DVM-CL Digital Video Head Cleaning Cassette	D36-0032-201



## Screen Displays

To display the date and time, press the DATA CODE button. See also p. 78.

Press the wireless controller's TV SCREEN button or turn TV SCREEN on through the menu to see the other displays on the TV screen. (The displays appear white on-screen.) They will not be added to any recordings you make with the camcorder.

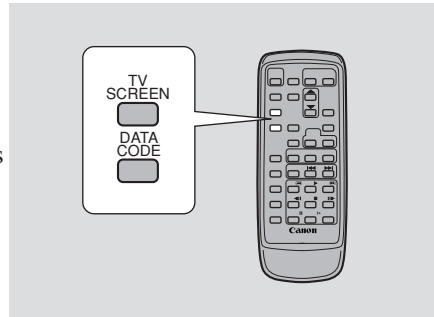

E

**TAPE** + **CAMERA** , **CARD** + **CAMERA**

**MENU**  
( 37)



**To turn TV SCREEN off, open the menu and select DISP.SET UP. Then select TV SCREEN, set it to OFF and close the menu.**

For instructions on how to hook the camcorder up to your TV, see p. 31.

### Turning off the LCD screen displays



You can turn off the displays to give you a clear screen for playback.

**TAPE** + **PLAY (VCR)** , **CARD** + **PLAY (VCR)**

**MENU**  
( 37)



**To turn the displays off, open the menu and select DISP. SET UP. Then select DISPLAYS, set it to OFF <PLAYBK> and close the menu.**

- If you turn the displays off, the LCD screen will be completely blank, but the camcorder will continue to show warning/caution displays when necessary.

 indicates a flashing display.

Record pause mode  
( 19)



Recording ( 20)



The backup battery is not properly installed, or needs replacing ( 124).

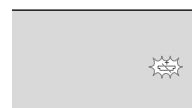

Additional  
Information

**E**

Shows how much battery power remains ( 123).



The battery pack is exhausted ( 123).



No cassette is loaded, or it is set for erasure prevention ( 17, 18).



Remaining tape  
(Green: more than five minutes.  
Yellow: less than five minutes.  
Red: final few seconds.)



...finally, it tells you when you have completely run out of tape.



The camcorder is ejecting the tape ( 17).



The safety mechanism is activated. Unload the cassette and turn the camcorder off. Turn it on again and reload the cassette.



Recording mode ( 21)

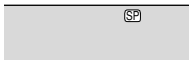

Playback is stopped ( 27).



Normal playback ( 27)



Fast forward ( 27)



Rewind ( 27)



Fast forward playback ( 28)



Rewind playback ( 28)



Frame advance playback ( 28)



Frame reverse playback ( 28)



Playback pause (forward and reverse) ( 28)



Slow playback (forward and reverse) ( 28)



×2 playback (forward and reverse) ( 28)



×1 playback (forward and reverse) ( 28)



Photo Search ( 81)



Date Search ( 81)



Zero set memory (forward and reverse) ( 82)

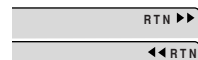

AV Insert Editing ( 88)



Audio Dubbing ( 91)

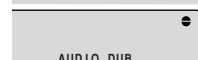

Zoom display ( 23):  
Optical zoom

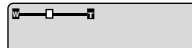

Optical plus 40×  
digital zoom

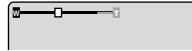

Optical plus 200×  
digital zoom



Zoom in

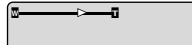

Zoom out



The image stabilizer is  
turned on ( 36).



CAM. MENU  
( 39)

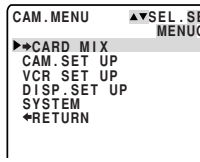

VCR MENU ( 40)

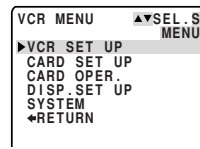

C. CAM. MENU  
( 42)

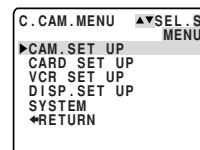

C. PLAY MENU  
( 43)

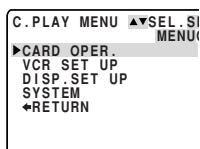

The remote sensor is  
turned off ( 46).



Self-timer countdown  
( 68)



Zero set memory  
( 82)



Audio mode ( 66)



Data code ( 78)



Photo mode ( 52)



- Setting the AF/AE. mark flashes white
- AF/AE locked. mark lights up green
- Timer

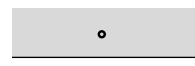

Recording programs  
( 55).

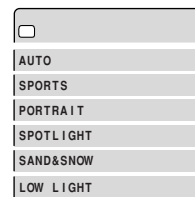

Accessory is attached  
to advanced accessory  
shoe ( 70, 71)



AE Shift ( 72)

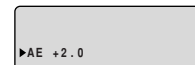

Manual focus is  
selected ( 75).

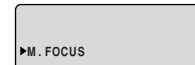

Shutter speed ( 73)

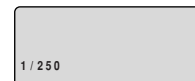

E

Additional  
Information

# E

White balance is ( 76)

- Set 
- Indoor 
- Outdoor 

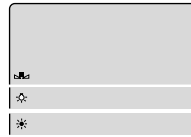

The 16:9 mode: the display flashes when the effect is being selected, and appears steadily when it is activated ( 22).



Digital effects. The display flashes when the function is being selected and appears steadily when it is activated ( 59).



The wind screen is turned on ( 67).



Volume level ( 30):  
Speaker

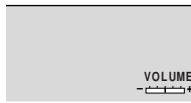

Headphones



The AV/headphone terminal is switched to headphones ( 31)



Audio output ( 94)

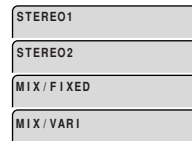

Mix balance ( 94)

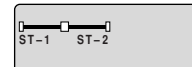

Audio input ( 92)



Microphone input



DV input ( 84, 104)



Condensation warning ( 128)



## Memory Card Displays

No memory card is inserted ( 98).



Image quality ( 98):  
Standard



Fine



Folder number-File number ( 100).



Slide show in progress ( 106).

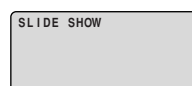

Additional Information

Recording to a memory card ( 97, 101).

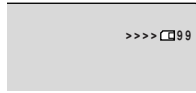

The number of still images that can still be recorded on the memory card ( 101).



(Green: 6 or more images.  
Yellow: Between 1 and 5 images  
Red: No more images)

Accessing a memory card ( 97).



Current still image/Total number of still images on the memory card ( 105).



Protect mark ( 107).

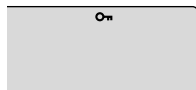

Card mix ( 112).

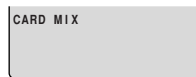

Print mark ( 115).

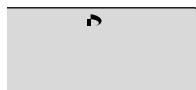

Data code ( 78).



## Time Code

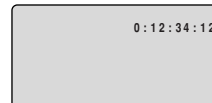

This records counter information, including hour, minute, second, and frame number on a special data code area on the tape itself. It is reset automatically when a new tape is loaded. In TAPE CAMERA mode, the frame number doesn't appear in the display.

## Recording reminder

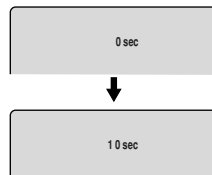

When you start recording, the camcorder counts from 0SEC to 10SEC. Shots which are shorter than ten seconds may be difficult to edit later. On the other hand, if you are not planning to edit the recording, remember that a shot which does not contain action should generally last no longer than 10 seconds.

**E****Caution phrases**

The camcorder displays various caution phrases — they appear for 4 seconds before disappearing.

Appears each time you turn the power on, until you set the time zone, date and time (  49).

SET THE TIME ZONE,  
DATE AND TIME

Appears as a warning to protect the cassette and also when condensation is detected. Remove the cassette as soon as possible after the camcorder has displayed the caution.

REMOVE THE CASSETTE

Refer to p. 85

Appears when the battery pack is exhausted (  124).

CHANGE THE BATTERY PACK

COPYRIGHT PROTECTED  
PLAYBACK IS RESTRICTED

Refer to p. 85 or p. 86

Appears when the tape has reached the end.

TAPE END

COPYRIGHT PROTECTED  
DUBBING RESTRICTED

Refer to p.18

THE TAPE IS SET FOR  
ERASURE PREVENTION

Appears when you try to do audio dubbing or AV insert on a tape recorded in any mode other than SP mode (  88, 91).

CHECK THE CASSETTE  
[REC MODE]

Appears if you press the REC PAUSE button when the DV cable is not connected properly (  85).

CHECK THE DV INPUT

Appears when you try to do audio dubbing on a tape recorded in 16-bit audio or 12-bit, 4-channel mode (  91-93).

CHECK THE CASSETTE  
[AUDIO MODE]

Refer to p. 128

CONDENSATION  
HAS BEEN DETECTED

Appears when the camcorder detects a blank section of a tape during audio dubbing or AV insert (  88, 91).

CHECK THE CASSETTE  
[BLANK]

Appears immediately after you start recording, and the video heads are badly contaminated. Make sure to clean the video heads when this caution appears.

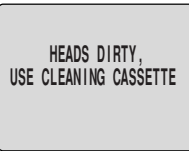

Appears if you have tried to mark 51 or more images for printing, or if a mark file cannot be edited. ( 115)



### Memory card caution phrases

An error has occurred with the memory card. The camcorder cannot record or play back. A temporary card error is also possible. If **CARD ERROR** disappears after 4 seconds and flashes red, format the memory card. If flashes green, playback is possible.



A memory card has not been inserted into the camcorder. ( 98)



There are no images recorded on the memory card.



You are using an SD Memory Card and it is set for erasure prevention. Change the position of the protect switch.

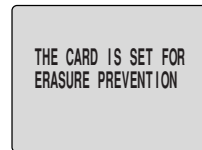

There is no more remaining memory on the memory card. Change the card or erase images.



You have reached the maximum file or folder number. ( 100)



The image has been recorded in an incompatible JPEG format or other format that the camcorder cannot play back, or the image data has been damaged.



# Specifications

E

## ZR30 MC

**Power Supply (rated):** 7.4 V DC

**Power Consumption (while recording with the AF turned on):**

3.7 W (Using viewfinder),

4.5 W (Using LCD screen)

**Television system:**

EIA standard (525 lines, 60 fields) NTSC color signal

**Video recording system:**

3 rotary heads, helical scanning

DV system (Consumer digital VCR

SD/SDL system)

Digital component recording

**Audio recording system:**

PCM digital sound: 16 bit (48kHz/2ch),

12 bit (32kHz/4ch)

■ SP and ■ LP: 12 bit only (32kHz/2ch)

**Image sensor:** 1/4" CCD (charge coupled device), approx. 460,000 pixels (approx. 290,000 effective pixels)

**Tape format:** Videocassettes bearing the Mini DV mark.

**Tape speed:**

SP: 3/4 ips (18.81 mm/s),

LP: 1/2 ips (12.56 mm/s),

■ SP: 3/8 ips (9.41 mm/s),

■ LP: 1/4 ips (6.28 mm/s)

**Maximum recording time (with an 80 min. cassette):**

SP: 80 min., LP: 120 min.,

■ SP: 160 min., ■ LP: 240 min.

**Fast forward/rewind time:**

Approx. 2 min. 20 sec. (with a 60 min. cassette)

**Lens:** F/1.8–2.9, 10× power zoom, 4.2–42.0 mm

**Focusing system:** TTL autofocus, manual focusing possible

**Minimum focusing distance:** 3ft 3<sup>3</sup>/<sub>8</sub> in (1 m) (3<sup>3</sup>/<sub>8</sub> in (1 cm) on maximum wide angle)

**Maximum shutter speed:**

1/8,000 sec.

(1/250 sec. when using a memory card)

**Minimum illumination:** 2 lx (using the Low Light program in TAPE CAMERA mode)

**Recommended illumination:**

More than 100 lx

**Filter diameter:** 30.5 mm

**Viewfinder:** 0.44 in, TFT color LCD, approx. 113,000 pixels

**LCD screen:** 2.5 in measured diagonally, TFT color, approx. 112,000 pixels

**Microphone:** Stereo electret condenser microphone

**DV terminal input/output:**

Special 4-pin connector (conforms to IEEE1394)

**AV/headphone terminal:**

ø 3.5 mm minijack

Audio input: –10dBV/ at least 40 kohms, (L, R), unbalanced

output: –10dBV (47 kohm load)/ less than 3 kohms, unbalanced

Video: 1 V<sub>p</sub>-p/75 ohms unbalanced

**S-video terminal input/output:**

1 V<sub>p</sub>-p (Y signal), 0.286 V<sub>p</sub>-p (C signal)

**MIC terminal input:** ø 3.5 mm stereo minijack, – 57 dBV (with 600 ohm mic)/ at least 5 kohms

**LANC terminal:** ø 2.5 mm mini minijack

**Operating temperature range:** 32–104 °F (0–40 °C)

**Dimensions:** 2<sup>1</sup>/<sub>4</sub> × 4 × 5<sup>1</sup>/<sub>4</sub> in (57 × 102 × 134 mm)

**Weight:** 1 lb 3 oz (540 g)

## BP-512 Battery Pack

**Battery type:** Rechargeable lithium ion battery

**Rated voltage:** 7.4 V DC

**Operating temperature:** 32°–104°F (0°–40°C)

**Battery capacity:** 1100 mAh

**Dimensions:** 1<sup>1</sup>/<sub>2</sub> × 7<sup>7</sup>/<sub>8</sub> × 2<sup>1</sup>/<sub>8</sub> in (38 × 21 × 55 mm)

**Weight:** 2<sup>1</sup>/<sub>2</sub> oz (70 g)

Weight and dimensions are approximate  
Errors and omissions excepted.  
Subject to change without notice.

Canon is a trademark of Canon Inc.



# Index

16:9, 22

## A

Abroad, Using the Camcorder, 127  
Accessories, 7, 134  
Adapter, AC, 12-14, 16  
AE Programs, 55  
AE Shift, 72  
Analog line-in, 86  
Art, 61  
Audio Dubbing, 91  
Audio Mix, 94  
Audio Mode, 66  
Audio Output, 95  
Audio Recording and Playback,  
30, 66, 94  
Audio/Video Terminal, 31  
Auto, 57  
Autofocus, 75, 130  
AV Insert, 88

## B

Backup Battery, 124  
Basic Recording, 19  
Battery Charger, 15-16  
Battery Pack, 13, 15-16, 122  
Beep, 22  
Black and White, 61  
Buttons, light-up, 48

## C

Cables, 7, 32  
Cassettes, 17  
Charging the Battery Pack,  
13, 15-16, 122  
Choosing a Recording Program, 55  
Cleaning the Camcorder, 126  
Clock, 51  
Combining Images, 110  
Condensation, 128  
Connecting to a PC, 96  
Connection to TV or VCR, 31  
Copying from Cassette to  
Memory Card, 113  
Copying from Memory Card to  
Cassette, 114

## D

Data Code, 78  
Date and Time, 49  
Date Search, 81  
Digital Effects, 59  
Digital Video, 7  
Digital Zoom, 23  
DV Dubbing, 84, 104

## E

Easy Recording, 57  
Editing to a VCR, 83  
Effects, 61  
Erasing Still Images from a  
Memory Card, 108  
Extended Recording Time  
Function, 21  
External Microphone, 66, 71, 91

E

Additional  
Information

**E****F**

Fade Trigger, 60  
Faders, 60  
Fast Forward, 27  
Feedback, 33  
File Numbers, 100  
Finding Your Way Around the ZR30 MC, 9  
Focusing, 75  
Formatting a Memory Card, 116

**H**

Head Cleaning, 127  
Headphones, 30, 31  
Horizontal Wipe, 60

**I**

Image Stabilizer, 36  
Image Quality, 98  
Index Screen, 106  
Introducing the ZR30 MC, 8

**L**

LANC, 83  
LCD Screen, 24  
Lens Cap, 120  
Light-up buttons, 48  
Loading Cassettes, 17  
Low Light, 58  
LP Mode, 21

**M**

Maintenance, 125  
Making Better Videos, 34  
Manual Focus, 75  
Memory Card Introduction, 97  
Menus, 37  
Microphone, 66, 71, 91  
Monitor Recording, 26  
Mosaic, 61  
Mosaic Fade, 60  
Multi-Image Screen, 64

**O**

Optional Accessories, 134

**P**

Pause, Record, 19  
PC Connection, 96  
Photo Search, 81  
Playback, 28  
Playback Connection, 31  
Playback Pause, 28  
Portrait, 57  
Power Adapter, 12-14, 16  
Powering Your Camcorder, 12  
Pre-Marked Position, 82  
Preparing the Camcorder, 120  
Preventing Accidental Erasure, 107  
Print Mark, 115  
Problems, 129  
Progressive Photo, 101  
Protect, 107

**R**

Recharging the Battery Pack, 123  
Recording, 19, 101  
Recording from Cassette to Memory Card, 103  
Recording from DV Device to Memory Card, 104  
Recording Programs, 55  
Record Pause Mode, 19  
Record Review, 54  
Record Search, 54  
Remote Control, 45  
Remote Sensor, 45-46  
Rewind, 27

**S**

S1 video input terminal, 32  
Sample images, 118  
Sand & Snow, 58  
Screen Displays, 137  
SD Memory Card, 97, 117  
Self-Timer, 68  
Sepia, 61  
Shutter Speed, 73  
Slide Show, 106  
Speaker, 30  
Specifications, 14, 119, 144  
SP Mode, 21  
Sports, 57  
Spotlight, 58  
Still Picture, 52, 101  
Storage, 126  
S-video, 32  
System Diagram, 133

**T**

Tape Protection, 18  
Telephoto, 23  
Temperature, 14, 122, 126, 144  
Time Code, 141  
Time Zone, 49  
Tips for Making Better Videos, 34  
Tripod, 34  
Troubleshooting, 129  
TV, 31, 137

**U**

Using the Camcorder Abroad, 127  
Using the Menus, 37

**V**

VCR, 31  
Vertical Wipe, 60  
Videocassettes, 17  
Video Heads, 127  
Video ID-1 system, 32  
Video Light, 70  
Viewfinder, 120, 126  
Viewing Still Images, 105

**W**

White Balance, 76  
Wide-angle, 23  
Widescreen TV, 22  
Wind Screen, 67  
Wipe, 60  
Wireless Controller, 45

**Z**

Zero Set Memory, 82  
Zooming, 23

**E**

## Menu at a Glance

E

Use the list below to quickly navigate the camcorder's menu. Functions are listed alphabetically.

Function	First make sure the camera is set to...				Then select it from this submenu and set.
	TAPE + CAMERA	TAPE + PLAY (VCR)	CARD + CAMERA	CARD + PLAY (VCR)	
16:9 effect	<input type="radio"/>				CAM.SET UP
6-sec. Date		<input type="radio"/>			DISP.SET UP
Audio dub		<input type="radio"/>			VCR SET UP
Audio mode	<input type="radio"/>	<input type="radio"/>			VCR SET UP
AV/headphones	<input type="radio"/>	<input type="radio"/>	<input type="radio"/>	<input type="radio"/>	VCR SET UP
Beep	<input type="radio"/>	<input type="radio"/>	<input type="radio"/>	<input type="radio"/>	SYSTEM
Brightness	<input type="radio"/>	<input type="radio"/>	<input type="radio"/>	<input type="radio"/>	DISP.SET UP
Button light	<input type="radio"/>	<input type="radio"/>	<input type="radio"/>	<input type="radio"/>	SYSTEM
Button light color	<input type="radio"/>	<input type="radio"/>	<input type="radio"/>	<input type="radio"/>	SYSTEM
Card mix	<input type="radio"/>				➔ CARD MIX
Copy - card to cassette				<input type="radio"/>	CARD OPER.
Copy - cassette to card		<input type="radio"/>			CARD OPER.
Data code		<input type="radio"/>			DISP.SET UP
Date/time display	<input type="radio"/>		<input type="radio"/>		DISP.SET UP
Date/time select		<input type="radio"/>		<input type="radio"/>	DISP.SET UP
Date/time set	<input type="radio"/>		<input type="radio"/>		SYSTEM
Displays		<input type="radio"/>		<input type="radio"/>	DISP.SET UP
Erase				<input type="radio"/>	CARD OPER.
File numbers		<input type="radio"/>	<input type="radio"/>		CARD SET UP
Format				<input type="radio"/>	CARD OPER.

Additional  
Information

Function	First make sure the camera is set to...				Then select it from this submenu and set.
	TAPE + CAMERA	TAPE + PLAY (VCR)	CARD + CAMERA	CARD + PLAY (VCR)	
Image stabilizer	<input type="radio"/>		<input type="radio"/>		CAM.SET UP
Mirror mode	<input type="radio"/>		<input type="radio"/>		DISP.SET UP
Mix level	<input type="radio"/>				➔ CARD MIX
Mix type	<input type="radio"/>				➔ CARD MIX
Output channel		<input type="radio"/>			VCR SET UP
Print mark				<input type="radio"/>	CARD OPER.
Protect				<input type="radio"/>	CARD OPER.
Quality		<input type="radio"/>	<input type="radio"/>		CARD SET UP
Record mode	<input type="radio"/>	<input type="radio"/>		<input type="radio"/>	VCR SET UP
Remote sensor mode	<input type="radio"/>	<input type="radio"/>	<input type="radio"/>	<input type="radio"/>	SYSTEM
Shutter speed	<input type="radio"/>		<input type="radio"/>		CAM.SET UP
Time zone/DST	<input type="radio"/>		<input type="radio"/>		SYSTEM
TV screen	<input type="radio"/>		<input type="radio"/>		DISP.SET UP
White balance	<input type="radio"/>		<input type="radio"/>		CAM.SET UP
Wind screen	<input type="radio"/>	<input type="radio"/>			VCR SET UP
Zoom	<input type="radio"/>		<input type="radio"/>		CAM.SET UP



**U.S.A.**

**E**

## **CANON® ZR30 MC DIGITAL VIDEO CAMCORDER LIMITED WARRANTY**

The limited warranty set forth below is given by Canon U.S.A., Inc. ("CUSA") with respect to each Canon ZR30 MC Digital Video Camcorder ("DV Camcorder") purchased and used in the United States.

Each Canon DV Camcorder, when delivered to you in new condition in its original container, is warranted against defective material or workmanship as follows: for a period of one (1) year from the date of original purchase (three (3) months in the case of the video head part), defective parts or DV Camcorders returned to a CUSA factory service center ("CUSA Center") or an authorized DV Camcorder service facility ("Service Facility"), and proven to be defective upon inspection, will be repaired or exchanged for new or comparable rebuilt parts or DV Camcorders. The warranty period for repaired or replacement parts or DV Camcorders shall begin upon shipment of the same, but shall in no event exceed the original warranty period of the defective part or DV Camcorder.

**Non-Canon brand peripheral equipment and software which may be distributed with Canon DV Camcorders are sold "AS IS", without warranty of any kind by CUSA, including any implied warranty regarding merchantability or fitness for a particular purpose. The sole warranty with respect to such non-Canon brand items is given by the manufacturer or producer thereof.**

CUSA shall have no responsibility under this limited warranty for use of Canon DV Camcorders in conjunction with incompatible peripheral equipment and incompatible software.

In order to obtain warranty service, contact the authorized Canon retail dealer from whom you purchased the DV Camcorder or call the CANON INFORMATION CENTER AT 1-800-828-4040 (which is open from 9:00 a.m. to 5:00 p.m. (E.S.T.), Monday through Friday, excluding holidays). Have your unit serial number and your date of purchase available when you make the call to expedite service. In either case you will be directed to ship the DV Camcorder, postage prepaid, to the CUSA Center or Service Facility nearest to you. You must include a copy of the proof of purchase (bill of sale) and a complete explanation of the problem. DV Camcorders covered by this limited warranty will be repaired and returned to you without charge by the CUSA Center or the Service Facility. Repairs not under warranty will be at such cost as the CUSA Center or Service Facility may from time to time generally establish.

This limited warranty covers all defects encountered in normal use of the DV Camcorder, and does not apply in the following cases:

- (a) Loss of or damage to the DV Camcorder due to abuse, mishandling, improper packaging by you, alteration, accident, leaking batteries, exterior nicks, scratches or dents, electrical current fluctuations, failure to follow operating instructions, maintenance and environmental instructions prescribed in CUSA's instruction manual, or service performed by other than a CUSA Center or Service Facility.
- (b) Use of parts or supplies (other than those sold by CUSA) which cause damage to the DV Camcorder or cause abnormally frequent service calls or service problems.
- (c) If any DV Camcorder has had its serial number or dating altered or removed.

This limited warranty does not apply to accessories or consumables for the DV Camcorder, which are sold "AS IS", without warranty of any kind by CUSA.

**NO IMPLIED WARRANTY, INCLUDING ANY IMPLIED WARRANTY OF MERCHANTABILITY OR FITNESS FOR A PARTICULAR PURPOSE, APPLIES TO THE DV CAMCORDER AFTER THE APPLICABLE PERIOD OF EXPRESS WARRANTY STATED ABOVE, AND NO OTHER EXPRESS WARRANTY OR GUARANTY, EXCEPT AS MENTIONED ABOVE, GIVEN BY ANY PERSON, FIRM OR CORPORATION WITH RESPECT TO THE DV CAMCORDER SHALL BIND CUSA. (SOME STATES DO NOT ALLOW LIMITATIONS ON HOW LONG AN IMPLIED WARRANTY LASTS, SO THE ABOVE LIMITATION MAY NOT APPLY TO YOU) CUSA SHALL NOT BE LIABLE FOR LOSS OF REVENUES OR PROFITS, EXPENSE FOR SUBSTITUTE EQUIPMENT OR SERVICE, STORAGE CHARGES, LOSS OF DATA, OR ANY OTHER SPECIAL, INCIDENTAL OR CONSEQUENTIAL DAMAGES CAUSED BY THE USE, MISUSE OR INABILITY TO USE THE DV CAMCORDER, REGARDLESS OF THE LEGAL THEORY ON WHICH THE CLAIM IS BASED, AND EVEN IF CUSA HAS BEEN ADVISED OF THE POSSIBILITY OF SUCH DAMAGES. NOR SHALL RECOVERY OF ANY KIND AGAINST CUSA BE GREATER IN AMOUNT THAN THE PURCHASE PRICE OF THE DV CAMCORDER SOLD BY CUSA AND CAUSING THE ALLEGED DAMAGE. WITHOUT LIMITING THE FOREGOING, YOU ASSUME ALL RISK AND LIABILITY FOR LOSS, DAMAGE OR INJURY TO YOU AND YOUR PROPERTY AND TO OTHERS AND THEIR PROPERTY ARISING OUT OF USE, MISUSE OR INABILITY TO USE THE DV CAMCORDER NOT CAUSED DIRECTLY BY THE NEGLIGENCE OF CUSA. (SOME STATES DO NOT ALLOW THE EXCLUSION OR LIMITATION OF INCIDENTAL OR CONSEQUENTIAL DAMAGES, SO THE ABOVE LIMITATION MAY NOT APPLY TO YOU.) THIS LIMITED WARRANTY SHALL NOT EXTEND TO ANYONE OTHER THAN THE ORIGINAL PURCHASER OF ANY DV CAMCORDER, OR THE PERSON FOR WHOM IT WAS PURCHASED AS A GIFT, AND STATES YOUR EXCLUSIVE REMEDY.**

This limited warranty gives you specific legal rights, and you may also have other rights which vary from state to state.

**Canon U.S.A., Inc.**  
One Canon Plaza  
Lake Success, New York 11042

**Additional  
Information**

## **CANON CONSUMER DIGITAL VIDEO EQUIPMENT LIMITED WARRANTY**

The limited warranty set forth below is given by Canon Canada Inc. ("Canon Canada") with respect to Canon digital video equipment purchased in Canada. This limited warranty is only effective upon presentation of a bill of sale or other proof of purchase for this Canon digital video equipment to a Canon Service Facility when repairs are required.

Canon consumer video digital equipment is warranted under normal, non-commercial, personal use, against defective materials or workmanship as follows:

**Parts:** Defective parts will be exchanged for new parts or, at Canon Canada's option, comparable rebuilt parts for a period of one year from the date of original purchase, except Video Heads which will be exchanged for a period of 3 months from the date of purchase.

**Labour:** For a period of one year from the date of original purchase, labour will be provided free of charge by our Canon Service Facilities in Canada.

This limited warranty covers all defects except where:

- (a) The loss or damage to the product results from:
    - i) accident, natural disaster, mishandling, abuse, neglect, unauthorized product modification or failure to follow instructions contained in the instruction manual;
    - ii) the use of accessories, attachments, products, supplies, parts or devices with this Canon product that do not conform to Canon specifications or that cause abnormally frequent service problems;
    - iii) repairs or services performed by any party other than a Canon Service Facility;
    - iv) defective batteries or any exposure to water, sand or dirt;
    - v) shipping (claim must be presented to the shipper);
  - (b) Any serial number on the video equipment is altered or removed.
  - (c) The digital video equipment is used for commercial, professional or industrial purposes.
- This limited warranty does not cover the cabinet (exterior finish) of the digital video equipment, video cassette tapes, head cleanings, nor does it apply to digital video equipment purchased outside Canada.

### **TO OBTAIN WARRANTY SERVICE**

Ship your Canon digital video equipment in its original carton, box or equivalent, properly packed, fully insured with shipping charges prepaid, together with a copy of your bill of sale or other proof of purchase and a description of the problem to any of the Canon Service Facilities in Canada.

### **LIMITATIONS**

Except as otherwise required by applicable legislation, this warranty is in lieu of all other warranties, conditions, guarantees or representations, express or implied, statutory or otherwise, relative to this Canon product, including implied warranties or conditions of merchantability or fitness for a particular purpose.

Canon Canada assumes no liability for special, consequential or incidental damages or loss that may arise, whether on account of negligence or otherwise, from the use, misuse or inability to use this Canon product (including loss of profit, revenue, video tapes or enjoyment) or from failure to conform to any express or implied warranties, conditions, guarantees or representations. Any recovery under this limited warranty shall not exceed the purchase price of the product. Canon Canada does not assume or authorize any other person to assume for Canon Canada any other liability with respect to this Canon product.

This warranty does not extend to any person other than the original purchaser of this Canon product or the person for whom it was purchased as a gift and states your exclusive remedy.

### **NOTICE TO CONSUMER**

If you plan to take important videos or if the product has not been used for some time, please check all functions with the instruction book before using it.