

ZANUSSI

LAVADORA
WASHING MACHINE

ZWF388

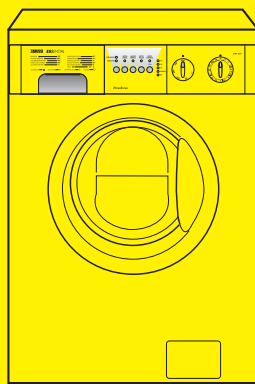

Child safety

- Children are often not aware of how dangerous electrical appliances can be. When the machine is working, children should be carefully supervised and not be allowed to play with the appliance.
- The packaging components (e.g. plastic film, polystyrene) can be dangerous to children - danger of suffocation! Keep them out of children's reach.
- Keep all detergents in a safe place out of children's reach.
- Make sure that children or pets do not climb into the drum.
- When the appliance is to be scrapped, cut off the electrical supply cable and destroy the plug with the remaining cable. Disable the door catch in order to prevent children from becoming trapped inside while playing.

Disposal

Packaging materials

The materials marked with the symbol  are recyclable.

>PE<=polyethylene

>PS<=polystyrene

>PP<=polypropylene

This means that they can be recycled by disposing of them properly in appropriate collection containers.

Machine





The symbol  on the product or on its packaging indicates that this product may not be treated as household waste. Instead it shall be handed over to the applicable collection point for the recycling of electrical and electronic equipment. By ensuring this product is disposed of correctly, you will help prevent potential negative consequences for the environment and human health, which could otherwise be caused by inappropriate waste handling of this product. For more detailed information about recycling of this product, please contact your local city office, your household waste disposal service or the shop where you purchased the product.

Tips for environmental protection

To save water, energy and to help protect the environment, we recommend that you follow these tips:

- Normally soiled laundry may be washed without prewashing in order to save detergent, water and time (the environment is protected too!).
- The machine works more economically if it is fully loaded.
- With adequate pre-treatment, stains and limited soiling can be removed; the laundry can then be washed at a lower temperature.
- Measure out detergent according to the water hardness, the degree of soiling and the quantity of laundry being washed.

Installation instructions

-  It is dangerous to alter the specifications or attempt to modify this product in any way.
-  Care must be taken to ensure that the appliance does not stand on the electrical supply cable.
-  Any electrical work required to install this appliance should be carried out by a qualified electrician or competent person.
-  Any plumbing work required to install this appliance should be carried out by a qualified plumber or competent person.
-  The power supply cable only can be replaced by a person of our Service Force Centre.

Technical specifications

DIMENSIONS	Height	85 cm
	Width	60 cm
	Depth	60 cm
MAXIMUM RECOMMEND LOAD	Cotton, linen	5 kg
	Synthetics	2 kg
	Delicates	2 kg
	Woollens	1 kg
SPIN SPEED		800 rpm máx.
POWER SUPPLY VOLTAGE/FREQUENCY		230 V/50 Hz
TOTAL POWER ABSORBED		2100 W
MINIMUM FUSE PROTECTION		10 A
WATER PRESSURE	Minimum	50 kPa
	Maximum	800 kPa



This appliance complies with the following EEC Directives:
73/23/EEC of 19/02/73 relating to low voltage
89/336/EEC of 03/05/89 relating to electromagnetic compatibility.

Installation

Transit security bars

Before starting the machine up, the **transport security bars must be removed** as follows:
You are advised to keep all the transport security bars. In case the appliance has to be transported again.

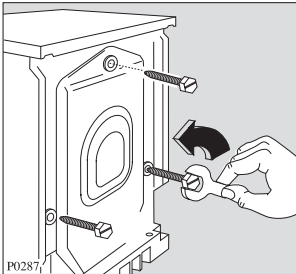

1. Unscrew and remove the three rear screws by means of a key.

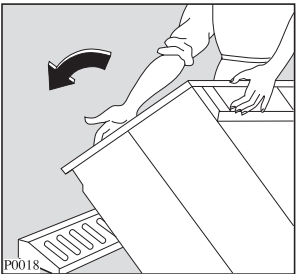

2. Lean the appliance back on the rear and fit one of the polystyrene angles between the appliance and the floor.

Make sure the hoses are not squashed.

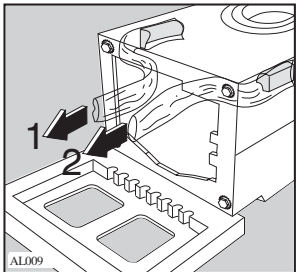

3. Carefully remove the plastic bags on the left and the right, pulling them to the centre of the appliance

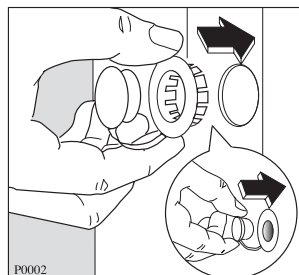
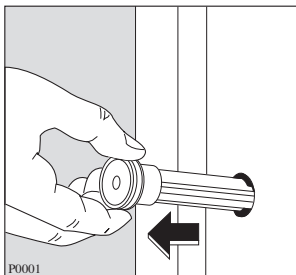

4. Place the machine in an upright position and remove the three plastic bolts.
5. Plug the 3 holes with the plastic plugs which you can find in the envelope containing the instruction booklet.

Hydraulic connection

There should be a **COLD WATER** tap near the washing machine with a screwing on connection pipe of 3/4 gas for the water supply, a sink, a wash basin or a drainage system in the wall.

Previously check if:

- it is not a hot water tap.
- the running water is clean. If not, run off a reasonable amount of water to flush out any debris that may have collected in the pipes.

Have the permanent drainage system in the wall checked by a plumber.

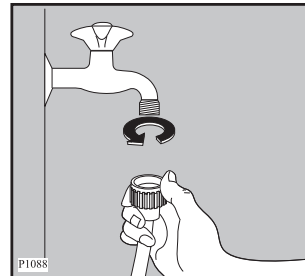

1. Carefully screw the pipe to the tap taking care not to damage the screwdriver and fix the nut well on to the end in order to avoid leaking.

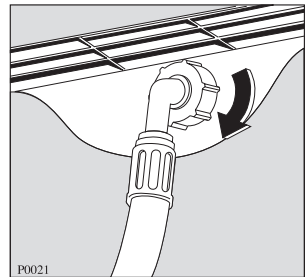

2. If necessary turn the hose adequately by unscrewing the nut at the rear of the appliance. Now tighten the nut anew to avoid leaks. (Open the tap and assure that it does not leak and close it again.)

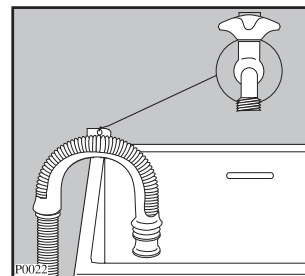

3. Place the discharging hose in a washbasin or sink with the aid of the bent piece delivered separately. The bent piece has to be entered into the tube's mouth in order to assure the support. Aforesaid piece allows the hose to be

fixed to the wall by means of an opening on the upper part and that way the hose does not move and its falling is avoided.

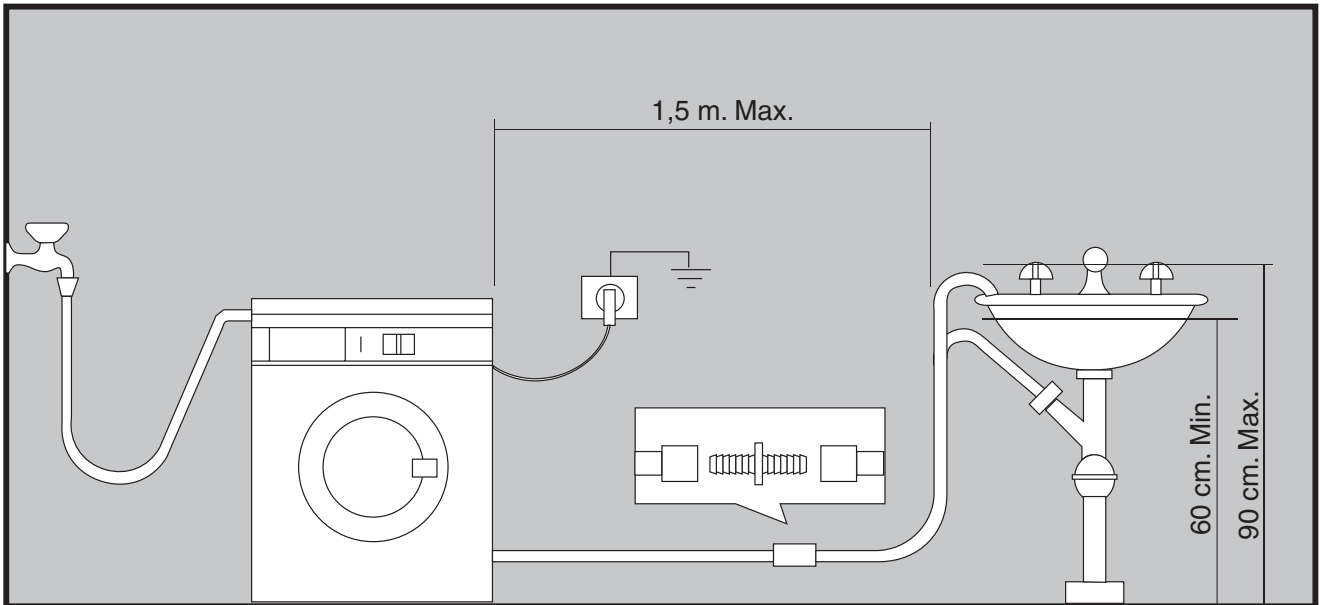

IMPORTANT: The distance from the floor to the highest part of the hose should be between 60 to 90 cm. (It is advised to be between 60 and 70 cm). The hose must not be bent nor twisted to avoid clogging. Should a prolongation of the discharging hose be unavoidable this must never surpass 1.5 m and must be of the same diameter as the original hose.
Make sure the hoses are not too tense.

Levelling

Level the appliance by loosening or tightening the feet. Once in the right position fix the feet by pushing the nuts (A) (see graphic P0254) against the base of the case. Accurate levelling will prevent vibration, noise and displacement of the appliance during operation.

Some vibration is inevitable, especially if placed on a wooden floor. Wooden floors are particularly susceptible to vibrations. If possible always place the appliance on a solid floor.

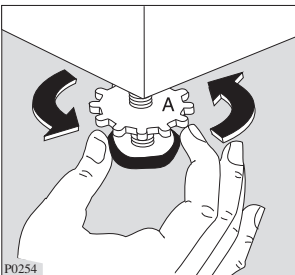

Electrical connections

Before plugging the appliance make sure that:

- 1°. the mains of your installation is the same as on the rating plate of your appliance (the plate is stuck to the rear of the appliance).
- 2°. The meter, the fuses, the wiring and the socket outlet can support the max. power absorbed stated on the rating plate.
- 3°. The socket base and the plug must fit in adequately without any reducing interposition, multiple outlets or adapters. If necessary replace the socket outlet by an adequate one.

The applicable rules for electrical security require an adequate earthing. The plug of the appliance is provided with such a device.

Make sure your socket outlet is provided with an adequate earthing too.

The manufacturer declines any liability in case of accidents or incidents should these safety measures not be observed.

The power supply cable only can be replaced by a person of our Service Force Centre.

Your new washing machine

This new machine meets all modern requirements for effective treatment of laundry with low water, energy and detergent consumption.



- **The balance control device** reduces the risk of instability in machine movement and it guarantees a quieter operation.

Description of the appliance

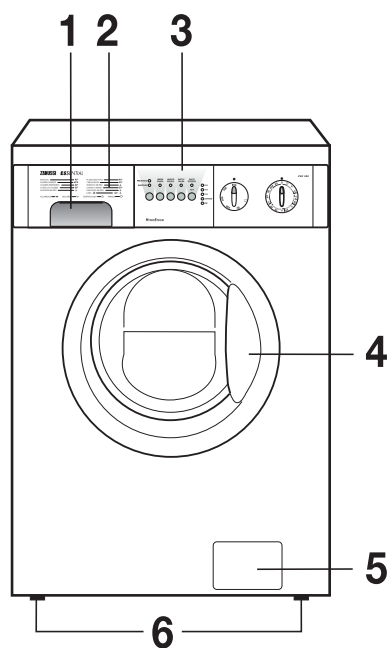
- 1 Detergent dispenser drawer
- 2 Programme chart
- 3 Control panel
- 4 Door handle
- 5 Drainage area door
- 6 Adjustable feet



Detergent dispenser drawer

-  Prewash
-  Main wash
-  Fabric softener, starch

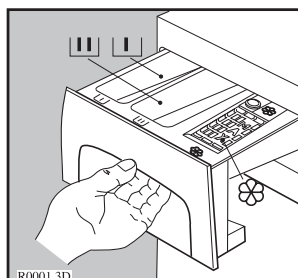

Use

Control panel

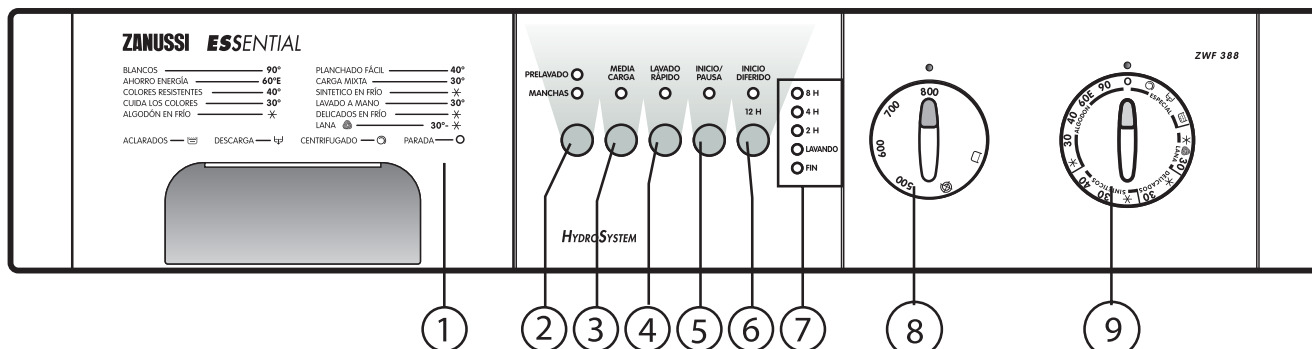

1. Detergent dispenser drawer

Programme option buttons

Depending on the programme, different option buttons can be combined.

When these buttons are pressed, the corresponding lights come on. When they are pressed again, the lights go off.

If an incompatible option with the selected programme has been chosen, the corresponding light flashes for about 2 seconds.

The option buttons: **PRELAVADO/MANCHAS**; **MEDIA CARGA** and **LAVADO RÁPIDO** must be selected after the required programme has been chosen, by turning the programme selector (see section 9) and before starting the machine, by pressing **INICIO / PAUSA** button.

2. PRELAVADO/ MANCHAS button

Adds a pre-wash phase at the start of the cycle with water heating to 30° C.

In COTTON and SYNTHETIC cycles, performs a short spin before passing to the washing phase. This option cannot be selected for LANA and LAVADO A MANO cycles.

3. MEDIA CARGA button

Select this button to reduce water consumption on the rinse cycle when washing a smaller load of cottons or linens (maximum load size = 2.25 kg). The machine will perform 2 rinses instead of 3.

4. LAVADO RÁPIDO button

Using this option, you can get good washing results in a short period of time, since with option, the COTTON, SYNTHETICS, and DELICATES programmes are modified in order to obtain short washing times (recommended for small or lightlysoiled loads).

This modification consists of reducing the number of rinse cycles (one less) and also increases the water level used in the remaining two rinse cycles.

5. INICIO / PAUSA button

After selecting the required programme, by the programme selector (see section 9), press this button to start the machine; the corresponding light stops flashing and will keep lighting until the programme finishes.

To interrupt the running programme, depress **INICIO / PAUSA** button: the corresponding light starts to flash.

To restart the programme from the point at which it was interrupted, press **INICIO / PAUSA** button again.

6. DELAY START button

This button allows the delay of starting of the washing programme by 12, 8, 4 and 2 hours. The delay which has been selected is indicated when the corresponding light comes on.

To use this option proceed as follows:

1. Select the required programme by the programme selector (see section 9).
2. Press the required option buttons.
3. Push DELAY START button, as many times as necessary to get the required delay until the corresponding light comes on
4. Press START / PAUSE button.

IMPORTANT!

- If you would like to cancel DELAY START option or to change the selected delay, proceed as follows:
 1. Turn the dial programme selector to position "O".
 2. Start the normal process to select a programme again.

- If you need to stop the machine to put in more laundry (having selected DELAY START option first), proceed as follows:

1. Depress START / PAUSE button.
2. Turn the dial programme selector to position "O".
3. **Wait two or three minutes before opening the door to give the electric locking mechanism time to release.**
4. Place the laundry in the drum.
5. Follow the normal operating sequence to select a programme.

DELAY START OPTION CAN'T BE SELECTED WITH  SPIN and  DRAIN programmes.

7. Programme progress display

When DELAY START option is chosen, the light relevant to the selected delay lights up.

After the machine has started, the remaining time is shown by the corresponding indicator light. During programme cycle the light WASHING will remain lit.

The light END will illuminate to indicate that the selected programme has finished.

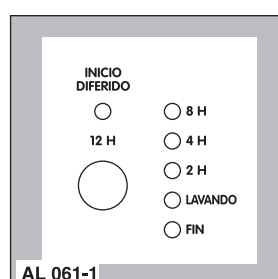



The light END flashes in the event of operating problems:

- 4 flashes: door open.
- 2 flashes: problem with water draining.
- 1 flash: problem with water supply.

For more information see paragraph "Something not working?" at the end of this booklet.

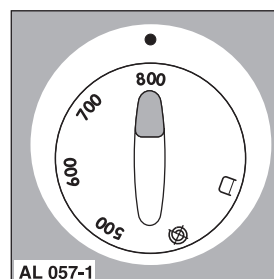

8. Spin speed selector dial or no spin / rinse hold options





This dial allows the reduction of the final and the intermediate spin speed or to select  NO SPIN or  RINSE HOLD options.

The position 800 r.p.m. corresponds to 700 r.p.m. for delicates.

Position 500 r.p.m. is common for all fabrics.

-  NO SPIN: by selecting this option all the spinning phases are turned off. To be used for extremely delicate items. The washing machine will add 3 rinses in the cotton programmes and 1 rinse in the synthetics programmes.
-  RINSE HOLD: by selecting this option, the water of the last rinse is not drained, in order to prevent the fabrics from wrinkling. When the programme has finished, **FIN** light will illuminate.

To drain the water follow these three steps:

- A) Turn the programme selector dial to "O".
- B) Select  DRAIN or  SPIN programme.
- C) Press **INICIO / PAUSA** button.

9. Programme selector dial

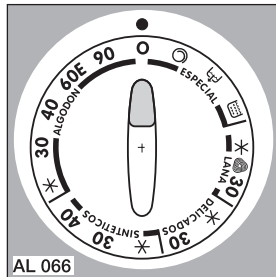

The selector dial can be turned either clockwise or counter-clockwise.

Use this selector dial to select the required programme.

At the end of each programme the selector dial must be turned to position “0”, to switch off the machine.

ATTENTION!

If the programme selector dial is turned to another position (programme) when the machine is working, the lights of the programme progress display start to flash. The machine will not perform the new selected programme, but it will continue running on the same cycle.

REMEMBER!

In the event a wrong programme has been selected and the machine is already working, proceed as follows:

1. Turn the programme selector dial to position “0”.
2. Select the new required programme.
 - If the machine has not already gone through the rinse cycle, when you decide to change the running programme, in the new programme the water and the detergent from the previous cycle will be re-used, making it an **energy-saving tool**. On the other hand, if it is already in the rinse phase; detergent, bleach,... must be re-measured.
3. Press **INICIO / PAUSA** button, to start the new cycle.

i Washing hints

Sorting the laundry

Follow the wash code symbols on each garment label and the manufacturer's washing instructions. Sort the laundry as follows: whites, coloureds, synthetics, delicates, woollens.

Temperatures

90° for normally soiled white cottons and linen (e.g. tea cloths, towels, tablecloths, sheets...)

60° for normally soiled, colour fast garments (e.g. shirts, night dresses, pyjamas...) in linen, cotton or synthetic fibres and for lightly soiled white cotton (e.g. underwear).

✱ (cold) 30°-40° for delicate items (e.g. net curtains), mixed laundry including synthetic fibres and woollens.

Before loading the laundry

Never wash whites and coloureds together. Whites may lose their "whiteness" in the wash.

New coloured items may run in the first wash; they should therefore be washed separately the first time.

Make sure that no metal objects are left in the laundry (e.g. hair clips, safety pins, pins).

Button up pillowcases, close zip fasteners, hooks and poppers. Tie any belts or long tapes.

Remove difficult stains before washing. Rub particularly soiled areas with a special detergent or detergent paste.

Treat curtains with special care. Remove hooks or tie them up in a bag or net.

Maximum loads

Recommended loads are indicated in the programme charts.

General rules:

Cotton, linen: drum full but not too tightly packed;

Synthetics: drum no more than half full;

Delicate fabrics and woollens: drum no more than one third full.

Washing a maximum load makes the most efficient use of water and energy.

For heavily soiled laundry, reduce the load size.

Laundry weights

The following weights are indicative:

bathrobe	1200 g
napkin	100 g
quilt cover	700 g
sheet	500 g
pillow case	200 g
tablecloth	250 g
towelling towel	200 g
tea cloth	100 g
night dress	200 g
ladies' briefs	100 g
man's work shirt	600 g
man's shirt	200 g
man's pyjamas	500 g
blouse	100 g
men's underpants	100 g

Removing stains

Stubborn stains may not be removed by just water and detergent. It is therefore advisable to treat them prior to washing.

Blood: treat fresh stains with cold water. For dried stains, soak overnight in water with a special detergent then rub in the soap and water.

Oil based paint: moisten with benzine stain remover, lay the garment on a soft cloth and dab the stain; treat several times.

Dried grease stains: moisten with turpentine, lay the garment on a soft surface and dab the stain with the fingertips and a cotton cloth.

Rust: oxalic acid dissolved in hot water or a rust removing product used cold. Be careful with rust stains which are not recent since the cellulose structure will already have been damaged and the fabric tends to hole.

Mould stains: treat with bleach, rinse well (whites and fast coloureds only).

Grass: soap lightly and treat with bleach (whites and fast coloureds only).

Glue: moisten with acetone (*), lay the garment on a soft cloth and dab the stain.

Lipstick: moisten with acetone as above, then treat stains with methylated spirits. Remove any residual marks from white fabrics with bleach.

Red wine: soak in water and detergent, rinse and treat with acetic or citric acid, then rinse. Treat any residual marks with bleach.

Ink: depending on the type of ink, moisten the fabric first with acetone (*), then with acetic acid; treat any residual marks on white fabrics with bleach and then rinse thoroughly.

Tar stains: first treat with stain remover, methylated spirits or benzine, then rub with detergent paste.

(* **do not use acetone on artificial silk.**)

Detergents and additives

Good washing results also depend on the choice of detergent and use of the correct quantities to avoid waste and protect the environment. Although biodegradable, detergents contain substances which, in large quantities, can upset the delicate balance of nature.

The choice of detergent will depend on the type of fabric (delicates, woollens, cottons, etc.), the colour, washing temperature and degree of soiling.

All commonly available washing machine detergents may be used in this appliance:

- powder detergents for all types of fabric,
- powder detergents for delicate fabrics (60°C max) and woollens,
- liquid detergents, preferably for low temperature wash programmes (60°C max) for all types of fabric, or special for woollens only.

The detergent and any additives must be placed in the appropriate compartments of the dispenser drawer before starting the wash programme.

If using concentrated powder or liquid detergents, a programme **without** prewash must be selected.

The washing machine incorporates a recirculation system which allows an optimal use of the concentrated detergent.

Pour liquid detergent into the dispenser drawer compartment marked  **just before** starting the programme.

Any fabric softener or starching additives must be poured into the compartment marked  before starting the wash programme.

Follow the product manufacturer's recommendations on quantities to use and **do not exceed the «MAX» mark in the detergent dispenser drawer.**

Quantity of detergent to be used

The type and quantity of detergent will depend on the type of fabric, load size, degree of soiling and hardness of the water used.

Water hardness is classified in so-called “degrees” of hardness. Information on hardness of the water in your area can be obtained from the relevant water supply company, or from your local authority.

Follow the product manufacturer's instructions on quantities to use.

Use less detergent if:













- you are washing a small load,
- the laundry is lightly soiled,
- large amounts of foam form during washing.



Degrees of water hardness





Level	Characteristic	Degrees	
		German °dH	French °T.H.
1	soft	0- 7	0-15
2	medium	8-14	16-25
3	hard	15-21	26-37
4	very hard	more than 21	more than 37





i International wash code symbols







These symbols appear on fabric labels, in order to help you choose the best way to treat your laundry.

Energetic wash   Delicate wash	 Max. wash temperature 95°C	 Max. wash temperature 60°C	 Max. wash temperature 40°C	 Max. wash temperature 30°C	 Hand wash	 Do not wash at all
	   					

 Bleaching	 Bleach in cold water	 Do not bleach
---	---	--

 Ironing	 Hot iron max 200°C	 Warm iron max 150°C	 Lukewarm iron max 110°C	 Do not iron
---	---	--	---	--

 Dry cleaning	 Dry cleaning in all solvents	 Dry cleaning in perchlorethylene, petrol, pure alcohol, R 111 & R 113	 Dry cleaning in petrol, pure alcohol and R 113	 Do not dry clean
--	---	--	--	---

 Drying	 Flat	 On the line	 On clothes hanger	 high temperature  low temperature Tumble dry	 Do not tumble dry
--	---	--	--	---	--

i Operating sequence

Before washing your first load of laundry, we recommend that you run a cotton cycle at 60° C, with the machine empty, in order to remove any manufacturing residue from the drum and tub. Pour half of the normal amount of detergent into the main wash compartment and start up the machine.

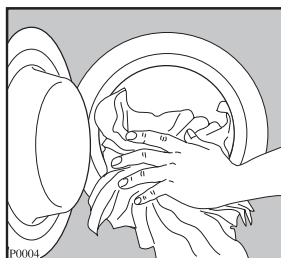

1. Place the laundry in the drum

Open the door by pulling the handle outwards. Place the laundry in the drum, one item at a time, shaking them out as much as possible. Close the door.



2. Measure the detergent

Pull out the dispenser drawer until it stops.

Measure the required amount of detergent, pour it into the main wash compartment  and into the compartment marked  (if  PRE-WASH option has been chosen).

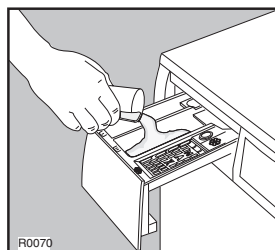

3. Measure the fabric softener

If required, pour fabric softener into the compartment marked  (the amount used must not exceed the "MAX" mark in the drawer).

Close the drawer gently.

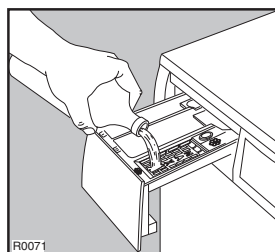

4. Select the required programme

Turn the programme selector to the required programme.

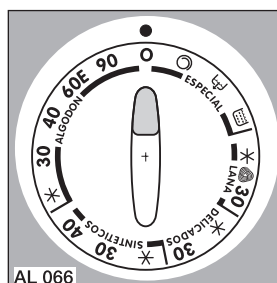

5. Select the spin speed or no spin / rinse hold options

Turn the spin selector to the required position.

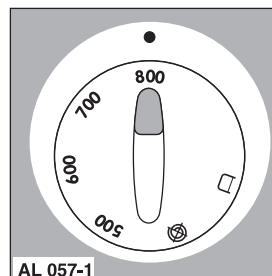

6. Select the required option push button/s

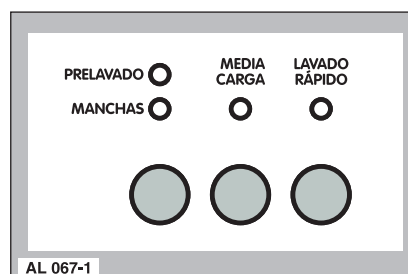

7. OPTIONAL! Select, if required, “DELAY START” option button

Push “DELAY START” button as many times as necessary until the corresponding light to the required delay (12H, 8H, 4H y 2H) comes on.

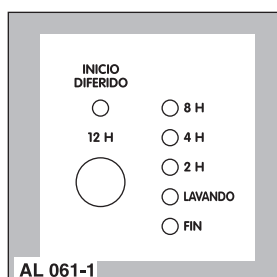

8. Start the machine

Before starting the machine check that:

- the appliance is plugged in.
- the water supply tap is turned on.
- the drain hose is correctly and securely positioned.
- the door and the detergent dispenser drawer are closed.

To start the selected programme, push **INICIO / PAUSA** button; the corresponding light will stop flashing and will remain lit until the end of the programme.

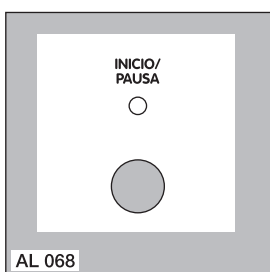

If “DELAY START” option has been chosen, the machine will begin the countdown.

9. Modification of a running washing programme

Once the programme has started, it only can be modified by turning the programme selector dial to “O” and afterwards the new programme can be chosen.

The washing water remains in the tub, provided that the machine does not reach the rinse phase, since, in this case, the machine drains it automatically.

Start the new programme by pressing **INICIO / PAUSA** button.

10. Interrupting a programme

Depress **INICIO / PAUSA** button to interrupt a running programme, the corresponding light will begin flashing. Press this button again to re-start the programme.

11. Opening the door after the programme has started

Firstly, stop the machine by pressing **INICIO / PAUSA** button.

After about two or three minutes the door can be opened.

If the door does not open, this means that the temperature of the water is too high, that the water level exceed the lower limit of the door (which could cause overflowing) or that the drum is spinning.

If the door cannot be opened but you need to open it, switch the machine off by turning the selector dial to “O”. After approximately two or three minutes the door can be opened. (PAY ATTENTION TO THE WATER LEVEL AND TEMPERATURE!)

12. At the end of the programme

The machine stops automatically.

Release of the lock is indicated when **FIN** light comes on.



Turn the programme selector dial to position “O” to switch the machine off.



Remove the laundry from the drum and carefully check that the drum is empty.

If you do not intend to put in another wash, turn off the water tap. Leave the door open to prevent from forming mildew and unpleasant smells.

ATTENTION!

If the  **RINSE HOLD** option has been selected, the last rinse water does not drain. To drain the water, carry out the following steps:







1. Turn the programme selector dial to “O”.
2. Select  **DRAIN** or  **SPIN** programme.



If programme  (**SPIN**) has been selected: Use the spin speed selector dial to choose the required speed. If the dial is kept in the same position as at the beginning, in other words  **RINSE HOLD** (no-wrinkle) position, the machine will spin at 400 r.p.m.

3. Press **INICIO / PAUSA** button

Programme table

Washing programmes for cotton and linen







Programme selector dial position	Washing programme	Stains and type of fabric	Description	Possible option	Load
90 ALGODÓN	BLANCOS	For heavily soiled cotton items.	Wash at 90° C 3 rinses Spin	Prelavado Manchas Inicio diferido Lavado rápido <input type="checkbox"/> Rinse hold (*) Media carga 	5 kg
60E ALGODÓN	AHORRO ENERGÍA (**)	White cotton, for example moderately soiled work garments, sheets, household linen, underwear, towels.	Wash at 60° C 3 rinses Spin	Prelavado Manchas Inicio diferido Lavado rápido <input type="checkbox"/> Rinse hold (*) Media carga 	5 kg
40 ALGODÓN	COLORES RESISTENTES	Fast coloured cotton or linen fabrics, moderately soiled, shirts, blouses, underwear.	Wash at 40° C 3 rinses Spin	Prelavado Manchas Inicio diferido Lavado rápido <input type="checkbox"/> Rinse hold (*) Media carga 	5 kg
30 ALGODÓN	CUIDA LOS COLORES	Non fast coloured cotton or linen fabrics, moderately soiled, shirts, blouses, underwear.	Wash at 30° C 3 rinses Spin	Prelavado Inicio diferido Lavado rápido <input type="checkbox"/> Rinse hold (*) Media carga 	5 kg
 ALGODÓN	ALGODÓN EN FRÍO	For slightly soiled cotton fabrics.	Cold wash 3 rinses Spin	Prelavado Inicio diferido Lavado rápido <input type="checkbox"/> Rinse hold (*) Media carga 	5 kg
O	PARADA	To cancel the running wash programme and to switch the machine off.			—



(*) When this option is selected, the last rinse water does not drain to avoid wrinkling in the fabrics. To drain the water select  **SPIN** or  **DRAIN** programme.

(**) In compliance with EC directive 92/75, the consumption figures indicated on the energy label refer to the 60° C wash programme for cotton (programme **E60**) with a wash load of 5 Kg.

Programme table





Washing programmes for synthetics, mixed fabrics, delicates, wool



Programme selector dial position	Washing programme	Stains and type of fabric	Description	Possible option	Load
40 SINTÉTICOS	PLANCHADO FÁCIL	Special programme for synthetic fabrics, which makes ironing easier.	Wash at 40° C 4 rinses Spin impulse	Prelavado Media carga Inicio diferido Lavado rápido <input type="checkbox"/> Rinse hold (*) 	2 kg
30 SINTÉTICOS	CARGA MIXTA	Synthetic or mixed fabrics, underwear, coloured garments, perma-press shirts, blouses.	Wash at 30° C 3 rinses Short spin	Prelavado Media carga Inicio diferido Lavado rápido <input type="checkbox"/> Rinse hold (*) 	2 kg
✳ SINTÉTICOS	SINTÉTICO EN FRÍO	Slightly soiled delicate synthetic fabrics.	Cold wash 3 rinses Short spin	Prelavado Media carga Inicio diferido Lavado rápido <input type="checkbox"/> Rinse hold (*) 	2 kg
30 DELICADOS	LAVADO A MANO	Epecially delicate fabrics.	Wash at 30° C 3 rinses Short spin	Media carga Inicio diferido <input type="checkbox"/> Rinse hold (*) 	2 kg
✳ DELICADOS	DELICADOS EN FRÍO	Delicate fabrics, such as curtains.	Cold wash 3 rinses Short spin	Prelavado Media carga Inicio diferido Lavado rápido <input type="checkbox"/> Rinse hold (*) 	2 kg
30- ✳ LANA 	LANA	Use this wash cycle to wash Woolmark garments according to the instructions on the garments label and following the instructions booklet provided by the manufacturer of this machine (M9604).	Cold wash or wash at 30° C (depending on the selected position) 3 rinses Short spin	Media carga Inicio diferido <input type="checkbox"/> Rinse hold (*) 	1 kg
O	PARADA	To cancel the running wash programme and to switch the machine off.			—

(*) When this option is selected, the last rinse water does not drain to avoid wrinkling in the fabrics. To drain the water select  **SPIN** or  **DRAIN** programme.

Programme table

Special washing programmes

Programme selector dial position	Washing programme	Stains and type of fabric	Description	Possible option	Load
	ACLARADOS	With this programme it is possible to rinse and spin garments which have been washed by hand. The machine performs 3 rinses, and it finishes with a short spin.	3 rinses Short spin	Inicio diferido Lavado rápido <input type="checkbox"/> Rinse hold (*) 	5 kg
	CENTRIFUGADO	This programme can be used to perform a short spin: for garments washed by hand, for example: to wring them out, before hanging them up. This programme can be used to drain and spin, too, when <input type="checkbox"/> RINSE HOLD option has been selected.	Short spin		5 kg
	DESCARGA	To drain the water from the last rinse in programmes with <input type="checkbox"/> RINSE HOLD option selected.	Water drain		5 kg
	PARADA	To cancel the running wash programme and to switch the machine off.			—

(*) When this option is selected, the last rinse water does not drain to avoid wrinkling in the fabrics. To drain the water select  **SPIN** or  **DRAIN** programme.

Maintenance

1. Bodywork

Clean the outside of the machine with warm water and a neutral, non-abrasive household detergent. Rinse with clean water and dry with a soft cloth.

Important: do not use methylated spirits, solvents or similar products to clean the bodywork.

2. Detergent dispenser drawer

After a while, detergents and fabric softeners leave deposits in the drawer.

Clean the drawer from time to time by rinsing it under a running tap. To remove the drawer from the machine, press the button in the rear left-hand corner.

To facilitate cleaning, the top part of the additive compartments can be removed.

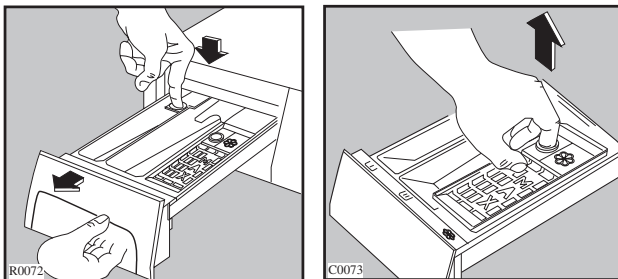

Detergent can also accumulate inside the drawer recess: clean it with an old toothbrush. Refit the drawer after cleaning.

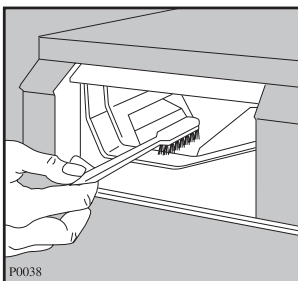

3. Cleaning of the drainage area

The drainage area must be cleaned if the pump has been blocked with objects such as buttons, safety pins, coins, etc. , or if lint has built up because clothes that generate lint have been washed at high temperatures.

- Pull out the plug from the power socket.
- If necessary, wait until the water has cooled down.
- Open the drainage area door.
- Place a bowl to collect the water.
- Release the emergency emptying hose, place it in the bowl and remove its cap, when the bowl is full put the cap back on the emergency emptying hose.
- Empty the bowl. Repeat the procedure until you have completely emptied the washing machine.

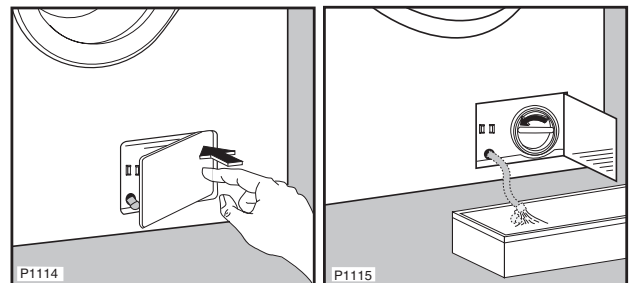

- To continue, unscrew the lid of the diaphragm by turning it counter clockwise and pull it out.
- Always keep a rag nearby to dry up spillage of water when removing the cover.
- Remove the objects such as buttons, coins and the lint that has been accumulated in the area of the pump impeller by rotating it.
- Screw the lid of the diaphragm clockwise, be sure is completely tighten.
- Replace the emergency emptying hose in its initial position and close the drainage area door.

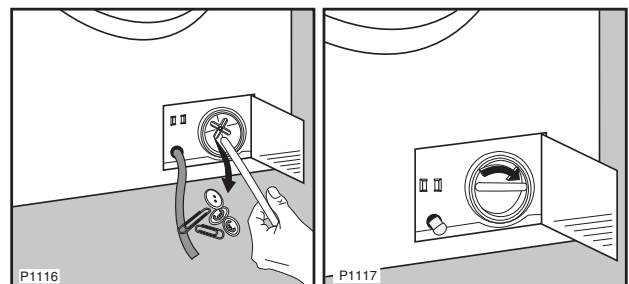

4. The water inlet hose filter

If your water is very hard or contains traces of lime deposit, the water inlet filter may become clogged.

It is therefore a good idea to clean it from time to time.

Turn off the water tap. Unscrew the water inlet hose.

Clean the filter using a hard bristle brush.

Tighten up the inlet hose.

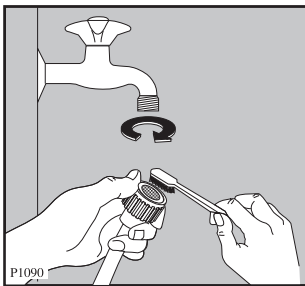

5. Emergency emptying out

If the water is not discharged (outlet pump is blocked, filter or drain hose are clogged), proceed as follows to empty out the machine:

- pull out the plug from the power socket;
- close the water tap;
- if necessary, wait until the water has cooled down;
- open the drainage area door;
- place a bowl to collect the water;
- release the emergency emptying hose, place it in the bowl and remove its cap, when the bowl is full put the cap back on the emergency emptying hose;
- empty the bowl, repeat the procedure until you have completely emptied the washing machine;
- replace the emergency emptying hose in its initial position and close the drainage area door.

6. Frost precautions

If the machine is installed in a place where the temperature could drop below 0°C, proceed as follows:

- disconnect the appliance;
- close the water tap;
- if necessary, wait until the water has cooled down;
- open the drainage area door;
- place a bowl to collect the water that will flow out;
- release the emergency emptying hose, place it in the bowl and remove its cap;
- when the water stops flowing out, put the cap back on the emergency emptying hose, replace the emergency emptying hose in its initial position and close the drainage area door.

By doing this, any water remaining in the machine is removed, avoiding the formation of ice and, consequently, breakage of the affected parts.

When you use the machine again, make sure that the ambient temperature is above 0°C.

Something not working?



Certain problems are due to lack of simple maintenance or oversights, which can be solved easily without calling technical service. Before contacting your local Service Force Centre, please check the following possible problems listed below.

During machine operation it is possible that **FIN** light flashes to indicate that something is not working correctly.

- 4 flashes = door open.
- 2 flashes = the water is not drained.
- 1 flash = there is no water filling.

Once the problem has been eliminated, press **INICIO / PAUSA** button to restart the programme. If after all checks, the problem persists, contact your local Service Centre.

Problems which can be resolved without a technician's help.

Problems	Possible cause
- The machine does not start up:	<ul style="list-style-type: none"> • The door has not been closed. • The plug is not properly inserted in the power socket. • There is no power in the socket. • The main fuse or the fuse in the plug has blown. • The programme selector dial is not correctly positioned and INICIO / PAUSA button has not been pressed.
- The machine does not fill:	<ul style="list-style-type: none"> • The water tap is off. • The filter in the inlet hose is blocked. • The inlet hose may be squashed or kinked. • The door has not been closed.
- The machine fills then empties immediately:	<ul style="list-style-type: none"> • The end of the drain hose is lower than the machine. • The end of the drain hose is submerged in water. • There is no air circulation in the installation, between the machine drain hose and the one in the house.
- The machine does not drain and / or does not spin:	<ul style="list-style-type: none"> • The drain hose may be squashed or kinked. •  RINSE HOLD option has been selected. • The drain pump may be blocked. • The drain hose extension is not correct. Follow the instructions to connect it to the drain. • The drainage system pipes are blocked. • The laundry load is off balance: redistribute the garments in the drum to allow the machine to spin. •  option has been selected.
- There is water on the floor:	<ul style="list-style-type: none"> • There is too much detergent or an inappropriate detergent has been used (it makes too much foam). • Check whether there are any leaks from one of the inlet hose fittings. It is not always easy to see this as the water runs down the hose; check to see if it is damp. • The drain hose may be damaged or is not securely positioned to prevent leaks. • The detergent dispenser drawer is clogged. • The drainage system pipes are blocked.

Problems	Possible cause
- Unsatisfactory washing results:	<ul style="list-style-type: none"> • Little detergent or an inappropriate one has been used. An insufficient amount of detergent leaves the laundry looking grey. • Stubborn stains have not been treated prior to washing. • The correct wash programme has not been selected. • Too much laundry has been placed in the drum.
- The machine vibrates when spinning:	<ul style="list-style-type: none"> • The transit bolts and packaging have not been removed. • The machine is in contact with the wall or furniture. • The machine is not level and stable (check diagonally). • The laundry is not well distributed in the drum. • There may not be enough laundry in the drum.
- The door does not open::	<ul style="list-style-type: none"> • The programme is still running. • The door lock has not released yet. • Water in the tub: if there is water in the tub, the door cannot be opened (<input type="checkbox"/> RINSE HOLD option selected).
- Spinning starts late or the machine does not spin:	<ul style="list-style-type: none"> • The electronic off balance detection device has interrupted the spin because the laundry is not evenly distributed in the drum. The laundry is redistributed by reverse rotation of the drum. This may happen several times before the off balance disappears and normal spinning can resume. If, after 10 minutes, the laundry is still not evenly distributed in the drum, the machine will not spin. In this case, redistribute the load manually and re-select the spin programme.
- The machine makes an unusual noise:	<ul style="list-style-type: none"> • The machine is fitted with a type of motor which makes an unusual noise compared to other traditional motors. This new motor ensures a smoother starting and an even distribution of the laundry in the drum when the machine is spinning. At the same time it increases the appliance stability.
- No water is visible in the drum:	<ul style="list-style-type: none"> • Appliances using modern technology are energy efficient. They use very little water without affecting washing results.

If you are unable to identify or solve the problem, contact our service centre. Before telephoning, make a note of the model, serial number and purchase date of your machine: the Service Centre will require this information.

