

ZANUSSI

LAVADORA WASHING MACHINE ZWF 260

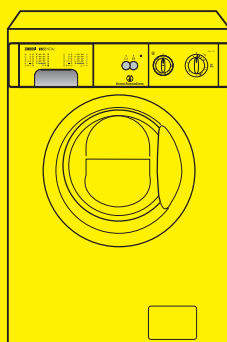

Dear customer,

Please read these operating instructions carefully and pay particular attention to the safety notes indicated in the first pages. We recommend that you keep this instruction booklet for future reference and pass it on to any future owners.

Transport damages

When unpacking the appliance, check that it is not damaged. If in doubt, do not use it and contact the Service Centre.

The symbols you will see on some paragraphs of this booklet have the following meaning:



The warning triangle and/or the key words (Warning!, Caution!) emphasize information that is particularly important for your safety or correct functioning of the appliance.



The information marked with this symbol provides additional instructions and practical tips on the use of the appliance.



Tips and information about economical and ecological use of the machine are marked with this symbol.

Contents

Warnings	24-25	Maintenance	38
Disposal	25	Bodywork	38
Tips for environmental protection	25	Detergent dispenser drawer	38
Technical specifications	26	Cleaning of the drainage area	38
Installation	27-28	Water inlet filter	39
Unpacking	27	Frost precautions	39
Hydraulic connection	27	Emergency emptying out	39
Levelling	28	Something not working?	40-41
Electrical connection	28		
Your new washing machine	29		
Description of the appliance	29		
Detergent dispenser drawer	29		
Use	30		
Control panel	30		
Controls	30		
Washing hints	31		
Sorting the laundry	31		
Temperatures	31		
Before loading the laundry	31		
Maximum loads	31		
Laundry weights	31		
Removing stains	31		
Detergents and additives	32		
International wash code symbols	33		
Operating sequence	34-35		
Washing programmes	36-37		

Warnings

The following warnings are provided in the interests of overall safety. You must read them carefully before installing or using the appliance.

Installation

- All internal packing must be removed before using the appliance. Serious damage may be caused to the machine or adjacent furniture if the protective transit devices are not removed or are not completely removed. Refer to the relevant paragraph in the instruction book.
- Any electrical work required to install this appliance must be carried out by a qualified electrician.
- Any plumbing work required to install this appliance must be carried out by a qualified plumber.
- After having installed the machine, check that it is not standing on its electrical supply cable.
- If the appliance is placed on a carpeted floor, ensure that air can circulate freely between the feet and the floor.

Use

- This appliance is designed for domestic use. It must not be used for purposes other than those for which it was designed.
- Only wash fabrics which are designed to be machine washed. Follow the instructions on each garment label.
- Do not overload the appliance. Follow the instructions in the instruction book.
- Make sure that all pockets are empty. Objects such as coins, safety pins, pins and screws can cause extensive damage.
- Do not machine wash garments saturated with petroleum, methylated spirits, trichlorethylene, etc. If such fluids have been used to remove stains prior to washing, wait until they have completely evaporated from the fabric before placing garments in the appliance.
- Place small items such as socks, belts, etc. in a cloth bag or pillowcase to prevent them getting trapped between the drum and the tub.
- Use only the recommended quantities of fabric softener. An excessive amount could damage the laundry.

- Leave the porthole door slightly ajar when the appliance is not in use. This preserves the door seal and prevents the formation of musty smells.
- Always check that water has emptied out before opening the door. If not, drain the water following the instructions in the instruction book.
- Always unplug the appliance and shut the water tap after use.

General safety

- Repairs to the machine must be carried out only by qualified personnel. Repairs carried out by inexperienced persons could cause serious danger. Contact your local Service Centre.
- Never pull the power supply cable to remove the plug from the socket; always take hold of the plug itself.
- During high temperature wash programmes the door glass may get hot. Do not touch it!

Child safety

- Children are often not aware of how dangerous electrical appliances can be. When the machine is working, children should be carefully supervised and not be allowed to play with the appliance.
- The packaging components (e.g. plastic film, polystyrene) can be dangerous to children - danger of suffocation! Keep them out of children's reach.
- Keep all detergents in a safe place out of children's reach.
- Make sure that children or pets do not climb into the drum.
- When the appliance is to be scrapped, cut off the electrical supply cable and destroy the plug with the remaining cable. Disable the door catch in order to prevent children from becoming trapped inside while playing.



Disposal

Packaging materials

The materials marked with the symbol  are recyclable.

>PE<=polyethylene

>PS<=polystyrene

>PP<=polypropylene

This means that they can be recycled by disposing of them properly in appropriate collection containers.

Machine



The symbol  on the product or on its packaging indicates that this product may not be treated as household waste. Instead it shall be handed over to the applicable collection point for the recycling of electrical and electronic equipment. By ensuring this product is disposed of correctly, you will help prevent potential negative consequences for the environment and human health, which could otherwise be caused by inappropriate waste handling of this product. For more detailed information about recycling of this product, please contact your local city office, your household waste disposal service or the shop where you purchased the product.



Tips for environmental protection

To save water, energy and to help protect the environment, we recommend that you follow these tips:

- Normally soiled laundry may be washed without prewashing in order to save detergent, water and time (the environment is protected too!).
- The machine works more economically if it is fully loaded.
- With adequate pre-treatment, stains and limited soiling can be removed; the laundry can then be washed at a lower temperature.
- Measure out detergent according to the water hardness, the degree of soiling and the quantity of laundry being washed.

Technical specifications

DIMENSIONS	Height	85 cm
	Width	60 cm
	Depth	60 cm
MAXIMUM LOAD	Cotton	5 kg
	Synthetics	2 kg
	Delicates	2 kg
	Woollens	1 kg
SPIN SPEED		600 rpm max.
POWER SUPPLY VOLTAGE/FREQUENCY		230 V/50 Hz
TOTAL POWER ABSORBED		2300 W
MINIMUM FUSE PROTECTION		10 A
WATER PRESSURE	Minimum	5 N/cm ²
	Maximum	80 N/cm ²



This appliance complies with the following EEC Directives:
73/23/EEC of 19/02/73 relating to low voltage
89/336/EEC of 03/05/89 relating to electromagnetic compatibility.

Installation

Transit security bars

Before starting the machine up, **the transport security bars must be removed** as follows:
You are advised to keep all the transport security bars in case the appliance has to be transported again.

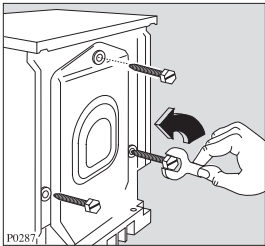

1. Unscrew and remove the three rear screws by means of a key.

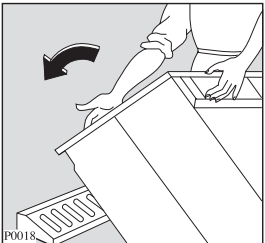

2. Lean the appliance back on the rear and fit one of the polystyrene angles between the appliance and the floor.

Make sure the hoses are not squashed.

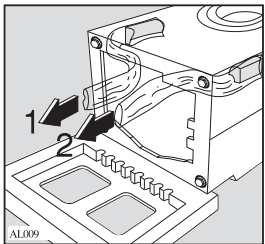

3. Carefully remove the plastic bags on the right and the left, pulling them to the centre of the appliance

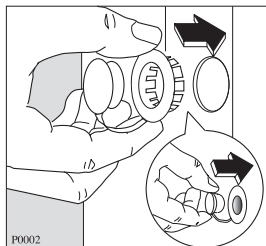
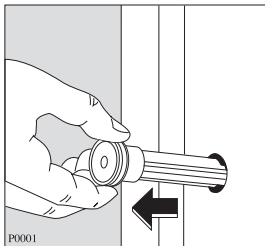

4. Place the machine in an upright position and remove the three plastic bolts.
5. Plug the 3 holes with the plastic plugs which you can find in the envelope containing the instruction booklet.

Hydraulic connection

There should be a **COLD WATER** tap near the washing machine with a screwing on connection pipe of 3/4 gas for the water supply, a sink, a wash basin or a drainage system in the wall.

Previously check if:

- it is not a hot water tap.
- the running water is clean. If not, run off a reasonable amount of water to flush out any debris that may have collected in the pipes.

Have the permanent drainage system in the wall checked by a plumber.

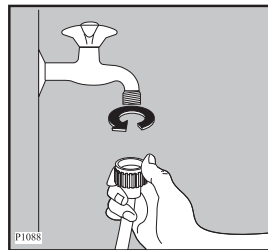

- A)** Carefully screw the pipe to the tap taking care not to damage the screwdrive and fix the nut well on to the end in order to avoid leaking.

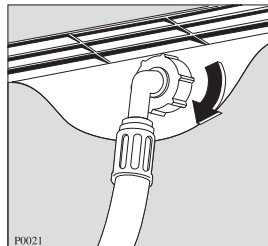

- B)** If necessary turn the hose adequately by unscrewing the nut at the rear of the appliance.

- C)** Now tighten the nut anew to avoid leaks. (Open the tap and assure that it does not leak and close it again.)

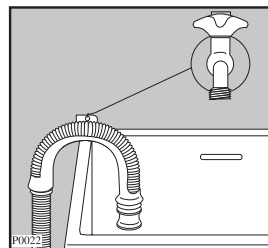

- D)** Place the discharging hose in a washbasin or sink with the aid of the bent piece delivered separately. The bent piece has to be entered into the tube's mouth in order to assure the support. Aforesaid piece allows the hose to be fixed to the wall by means of an opening on the upper part and that way the hose does not move and its falling is avoided.

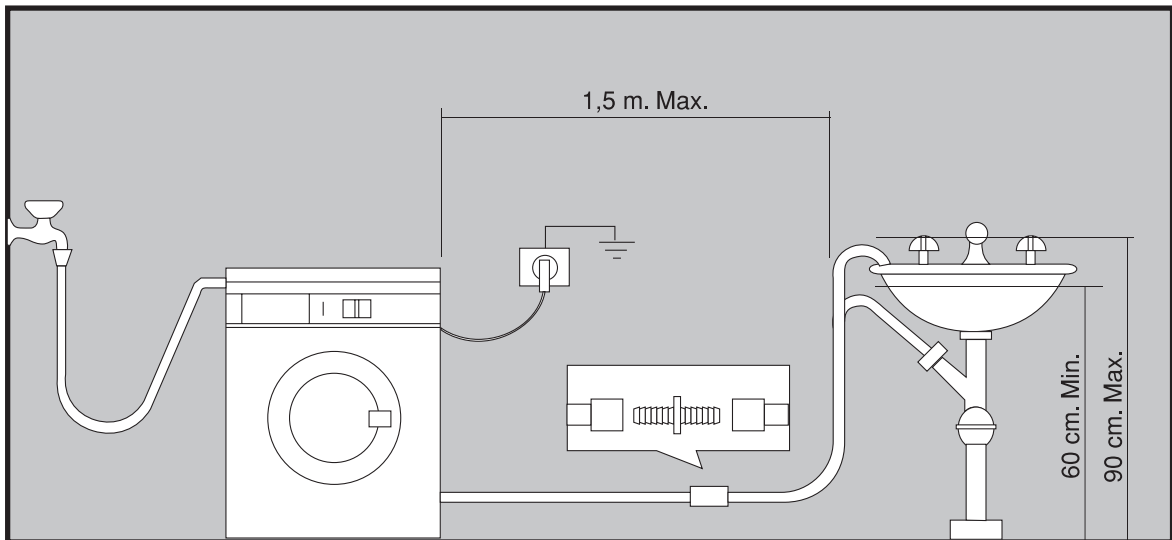

IMPORTANT: The distance from the floor to the highest part of the hose should be between 60 to 90 cm. (It is advised to be between 60 and 70 cm). The hose must not be bent nor twisted to avoid clogging. Should a prolongation of the discharging hose be unavoidable this must never surpass 1.5 m and must be of the same diameter as the original hose.

Make sure the hoses are not too tense.

Levelling

Level the appliance by loosening or tightening the feet. Once in the right position fix the feet by pushing the nuts against the base of the case. Accurate levelling will prevent vibration, noise and displacement of the appliance during operation.

Some vibration is inevitable, especially if placed on a wooden floor. Wooden floors are particularly susceptible to vibrations. For advice, consult a builder. If possible always place the appliance on a solid floor.

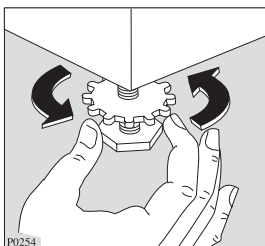

Electrical connections

Before plugging the appliance make sure that:

- 1°. the mains of your installation is the same as on the rating plate of your appliance (the plate is stuck to the rear of the appliance).
- 2°. The meter, the fuses, the wiring and the socket outlet can support the max. power absorbed stated on the rating plate.
- 3°. The socket base and the plug must fit in adequately without any reducing interposition, multiple outlets or adapters. If necessary replace the socket outlet by an adequate one.

The applicable rules for electrical security require an adequate earthing. The plug of the appliance is provided with such a device.

Make sure your socket outlet is provided with an adequate earthing too.

The manufacturer declines any liability in case of accidents or incidents should these safety measures not be observed.

The power supply cable only can be replaced by a person of our Service Force Centre.

Your new washing machine

This new machine meets all modern requirements for effective treatment of laundry with low water, energy and detergent consumption.



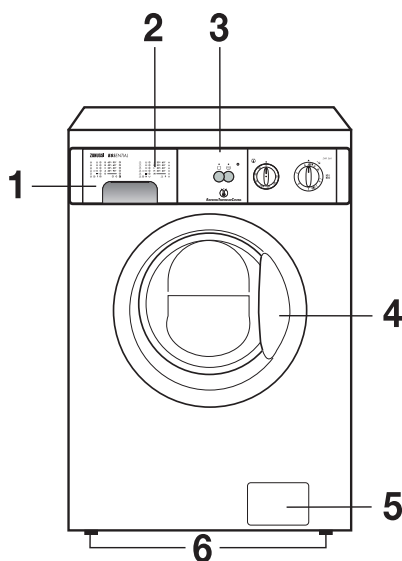

- **The temperature selector dial** will allow you to choose the most suitable temperature for your laundry.

Description of the appliance

- 1 Detergent dispenser drawer
- 2 Programme chart
- 3 Control panel
- 4 Door handle
- 5 Drainage area door
- 6 Adjustable feet



Detergent dispenser drawer

-  Prewash
-  Main wash
-  Fabric softener, starch
-  Bleaching agent

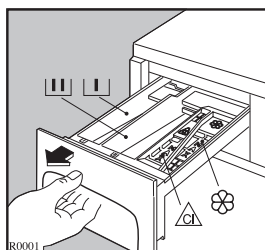

Use

Control panel

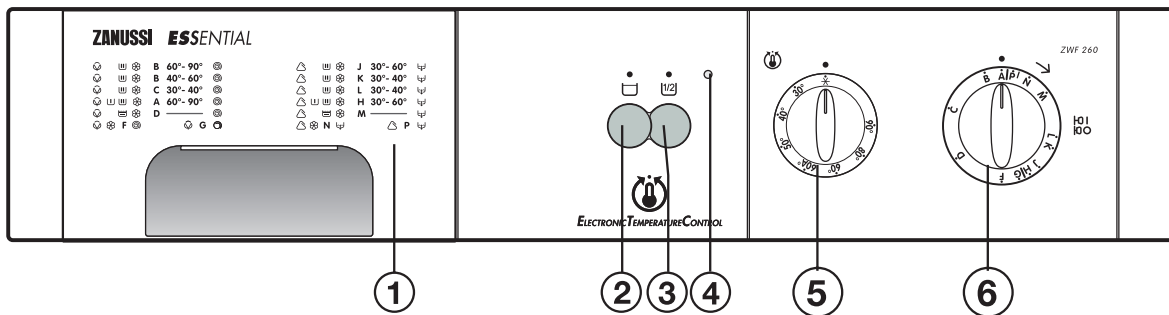

1 Programme chart

It will help you to choose the most suitable washing programme for your laundry.

2. RINSE HOLD button

(Easy iron. If you use this button it will be easier to iron the fabrics later).

Pressing this button together with the programs for delicate fabrics, the water will hold up in the wash tub at the end of the cycle. Press again to drain the water and take out the clothes.

3 ECONOMY button

Pressing this button before starting the intense program there will be one rinse less which leads to energy and water saving.

4 On/off lamp

It lights when the appliance is operating.

5 Temperature selector

This control allows you to select the temperature of the washing cycle in accordance with the kind of clothes to be washed.

Turn the control until the required temperature coincides with the marker.

On the program table you will find the most appropriate temperature for each kind of washing. Selecting  any program can be run through with cold water. This will ensure a saving in electricity consumption.

6. Program selector

To select the required program turn the control clockwise until the marker on the top coincides with the letter of the required program (reference mark on the control panel). If at any chance you pass by the required letter **NEVER TURN THE CONTROL ANTICLOCKWISE** just continue clockwise until the required letter is reached again.

i Washing hints

Sorting the laundry

Follow the wash code symbols on each garment label and the manufacturer's washing instructions. Sort the laundry as follows:
whites, coloureds, synthetics, delicates, woollens.

Temperatures

- 90°** for normally soiled white cottons and linen (e.g. tea cloths, towels, tablecloths, sheets...)
- 60°** for normally soiled, colour fast garments (e.g. shirts, night dresses, pyjamas....) in linen, cotton or synthetic fibres and for lightly soiled white cotton (e.g. underwear).
- ✱ (cold) 30°-40°** for delicate items (e.g. net curtains), mixed laundry including synthetic fibres and woollens.

Before loading the laundry

Never wash whites and coloureds together. Whites may lose their "whiteness" in the wash.

New coloured items may run in the first wash; they should therefore be washed separately the first time.

Make sure that no metal objects are left in the laundry (e.g. hair clips, safety pins, pins).

Button up pillowcases, close zip fasteners, hooks and poppers. Tie any belts or long tapes.

Remove persistent stains before washing. Rub particularly soiled areas with a special detergent or detergent paste.

Treat curtains with special care. Remove hooks or tie them up in a bag or net.

Maximum loads

Recommended loads are indicated in the programme charts.

General rules:

Cotton, linen: drum full but not too tightly packed;

Synthetics: drum no more than half full;

Delicate fabrics and woollens: drum no more than one third full.

Washing a maximum load makes the most efficient use of water and energy.

For heavily soiled laundry, reduce the load size.

Laundry weights

The following weights are indicative:

bathrobe	1200 g
napkin	100 g
quilt cover	700 g
sheet	500 g
pillow case	200 g
tablecloth	250 g
towelling towel	200 g
tea cloth	100 g
night dress	200 g
ladies' briefs	100 g
man's work shirt	600 g
man's shirt	200 g
man's pyjamas	500 g
blouse	100 g
men's underpants	100 g

Removing stains

Stubborn stains may not be removed by just water and detergent. It is therefore advisable to treat them prior to washing.

Blood: treat fresh stains with cold water. For dried stains, soak overnight in water with a special detergent then rub in the soap and water.

Oil based paint: moisten with benzine stain remover, lay the garment on a soft cloth and dab the stain; treat several times.

Dried grease stains: moisten with turpentine, lay the garment on a soft surface and dab the stain with the fingertips and a cotton cloth.

Rust: oxalic acid dissolved in hot water or a rust removing product used cold. Be careful with rust stains which are not recent since the cellulose structure will already have been damaged and the fabric tends to hole.

Mould stains: treat with bleach, rinse well (whites and fast coloureds only).

Grass: soap lightly and treat with bleach (whites and fast coloureds only).

Ball point pen and glue: moisten with acetone (*), lay the garment on a soft cloth and dab the stain.

Lipstick: moisten with acetone as above, then treat stains with methylated spirits. Remove any residual marks from white fabrics with bleach.

Red wine: soak in water and detergent, rinse and treat with acetic or citric acid, then rinse. Treat any residual marks with bleach.

Ink: depending on the type of ink, moisten the fabric first with acetone (*), then with acetic acid; treat any residual marks on white fabrics with bleach and then rinse thoroughly.

Tar stains: first treat with stain remover, methylated spirits or benzine, then rub with detergent paste.

(* **do not use acetone on artificial silk.**)

Detergents and additives

Good washing results also depend on the choice of detergent and use of the correct quantities to avoid waste and protect the environment. Although biodegradable, detergents contain substances which, in large quantities, can upset the delicate balance of nature.

The choice of detergent will depend on the type of fabric (delicates, woollens, cottons, etc.), the colour, washing temperature and degree of soiling.

All commonly available washing machine detergents may be used in this appliance:

- powder detergents for all types of fabric,
- powder detergents for delicate fabrics (60°C max) and woollens,
- liquid detergents, preferably for low temperature wash programmes (60°C max) for all types of fabric, or special for woollens only.

The detergent and any additives must be placed in the appropriate compartments of the dispenser drawer before starting the wash programme.

If using concentrated powder or liquid detergents, a programme **without** prewash must be selected.

The washing machine incorporates a recirculation system which allows an optimal use of the concentrated detergent.

Pour liquid detergent into the dispenser drawer compartment marked  **just before** starting the programme.

Any fabric softener or starching additives must be poured into the compartment marked  before starting the wash programme.

The bleaching agent (chlorine) can be used only for white or fast coloured cotton and linen items.

Pour it into the compartment marked .

Follow the product manufacturer's recommendations on quantities to use and **do not exceed the «MAX» mark in the detergent dispenser drawer.**

Quantity of detergent to be used

The type and quantity of detergent will depend on the type of fabric, load size, degree of soiling and hardness of the water used.

Water hardness is classified in so-called “degrees” of hardness. Information on hardness of the water in your area can be obtained from the relevant water supply company, or from your local authority.

Follow the product manufacturers' instructions on quantities to use.

Use less detergent if:









- you are washing a small load,
- the laundry is lightly soiled,
- large amounts of foam form during washing.



Degrees of water hardness





Level	Characteristic	Degrees	
		German °dH	French °T.H.
1	soft	0- 7	0-15
2	medium	8-14	16-25
3	hard	15-21	26-37
4	very hard	more than 21	more than 37



i International wash code symbols







These symbols appear on fabric labels, in order to help you choose the best way to treat your laundry.

<p>Energetic wash</p>   <p>Delicate wash</p>	 <p>Max. wash temperature 95°C</p>	 <p>Max. wash temperature 60°C</p>	 <p>Max. wash temperature 40°C</p>	 <p>Max. wash temperature 30°C</p>	 <p>Hand wash</p>	 <p>Do not wash at all</p>
---	---	---	---	---	---	---

 <p>Bleaching</p>	 <p>Bleach in cold water</p>	 <p>Do not bleach</p>
---	---	---

 <p>Ironing</p>	 <p>Hot iron max 200°C</p>	 <p>Warm iron max 150°C</p>	 <p>Lukewarm iron max 110°C</p>	 <p>Do not iron</p>
---	---	--	--	--

 <p>Dry cleaning</p>	 <p>Dry cleaning in all solvents</p>	 <p>Dry cleaning in perchlorethylene, petrol, pure alcohol, R 111 & R 113</p>	 <p>Dry cleaning in petrol, pure alcohol and R 113</p>	 <p>Do not dry clean</p>
--	---	--	---	---

 <p>Drying</p>	 <p>Flat</p>	 <p>On the line</p>	 <p>On clothes hanger</p>	 <p>high temperature</p>  <p>low temperature</p> <p>Tumble dry</p>	 <p>Do not tumble dry</p>
--	---	--	--	--	--

Operating sequence

Before washing your first load of laundry, we recommend that you run a cotton cycle at 60°C, with the machine empty, in order to remove any manufacturing residue from the drum and tub. Pour half a measure of detergent into the main wash compartment and start up the machine.

1. Place the laundry in the drum

Open the door.

Place the laundry in the drum, one item at a time, shaking them out as much as possible.

Close the door.

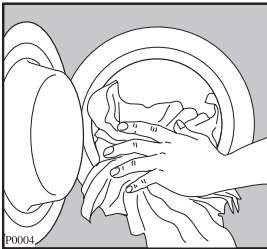



2. Measure out the detergent

Pull out the dispenser drawer until it stops. Measure out the amount of detergent recommended by the manufacturer in a graduated cup and pour it into the main wash compartment .

If you wish to carry out the prewash, pour detergent into the appropriate compartment marked .

3. Measure out the additives

If required, pour fabric softener into the compartment marked , and bleach into the compartment marked  **without exceeding the «MAX» mark.**

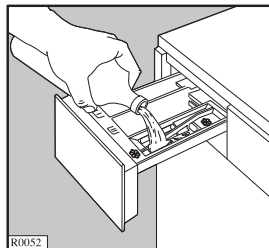
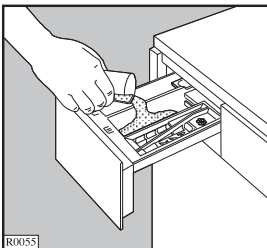

4. Select the temperature

Turn the dial to the required setting.

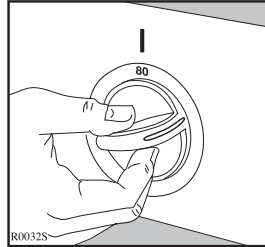

5. Select the option push button/s.

6. Select the programme and start the machine

Turn the programme selector dial **clockwise** to the required programme.

Before pulling the On/off programme selector check if:

- The door is properly closed.
- The appliance is plugged in.
- The water supply tap is turned on.
- The diaphragm lid is correctly screwed into place.
- The drain hose is adequately positioned.

Pull the program dial up to you till it clicks.

The pilot light comes on and the program will begin.

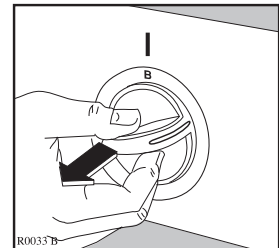
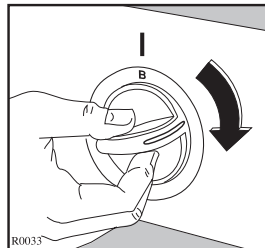

7. At the end of the programme

The machine stops automatically. The mains on light goes out.

If you have selected a programme which ends with the water of the last rinse left in the tub, drain the water before opening the door. Select programme "P" (drain) or "G" (spin).

Wait two or three minutes before opening the door to give the electric locking mechanism time to release it.

Remove the laundry.

Turn the drum by hand to make sure it is completely empty, so as to avoid any forgotten items being damaged in a subsequent wash (e.g. shrinking) or their colour running into a load of whites.

Release any buttons which have been pressed.





Turn the water tap off and unplug the machine.

Leave the door ajar to air the machine.

Programme table

Washing programmes for cotton and linen

Load: 5 kg







Programme	Temp.	Fabrics	Additional functions	DESCRIPTION
A	60°-90°	WHITES WITH PREWASH, for example work garments, sheets, household linen, underwear, towels		Prewash Wash at 60°-90°C 4 rinses Spin
B	60°-90°	WHITES WITHOUT PREWASH, for example household linen, sheets, shirts, underwear		Wash at 60°-90°C 4 rinses Spin
B	40°-60°	FAST COLOUREDS, for example shirts, blouses, terry cloths, underwear		Wash at 40°-60°C 4 rinses Spin
C	30°-40°	NON FAST COLOUREDS slightly soiled laundry		Wash at 30°-40°C 4 rinses Spin
D Rinses	✱ (COLD)	This programme can be used for rinsing hand washed garments		4 rinses Spin
F Softeners	✱ (COLD)	For hand washed items to be softened		Load additif 1 rinse Spin
G Long spin		Separate spin for cotton and linen		Spin

In compliance with EC directive 92/75, the consumption figures indicated on the energy label refer to the wash programme "B" for cotton with the temperature selector in the position **60A** and with a wash load of 5 kg.

Programme table

Washing programmes for synthetics, mixed fabrics, delicates and wool

Load: 2 kg, wool 1 kg

Programme	Temp.	Fabrics	Additional functions	DESCRIPTION
H	30°-60°	SYNTHETICS WITH PREWASH, for example underwear, coloured items, shirts, blouses	 (*)	Prewash at 30°C Wash at 30°-60°C 3 rinses Water drain
J	30°-60°	SYNTHETICS WITHOUT PREWASH, for example shirts, blouses, mixed fabrics	 (*)	Wash at 30°-60°C 3 rinses Water drain
K	30°-40°	EXPRESS slightly soiled laundry	 (*)	Wash at 30°-40°C 3 rinses Water drain
L	30°-40°	WOOL	 (*)	Wash at 30°-40°C 3 rinses Water drain
M Rinses	✕ (COLD)	This programme can be used for rinsing hand washed garments	 (*)	3 rinses Water drain
N Softeners		For hand washed items to be softened	 (*)	Load additif 1 rinse Water drain
P Drain		For emptying out the water		Drain water drum stands still

(*) When this button is pressed, the last rinse water of these programmes is not emptied out, so as to avoid creasing if the laundry is not removed from the machine immediately after washing. To drain the water select programme "G" (spin) or "P" (drain).

Maintenance

1. Bodywork

Clean the outside of the machine with warm water and a neutral, non-abrasive household detergent. Rinse with clean water and dry with a soft cloth.

Important: do not use methylated spirits, solvents or similar products to clean the bodywork.

2. Detergent dispenser drawer

After a while, detergents and fabric softeners leave deposits in the drawer.

Clean the drawer from time to time by rinsing it under a running tap. To remove the drawer from the machine, press the button in the rear left-hand corner.

To facilitate cleaning, the top part of the additive compartments can be removed.

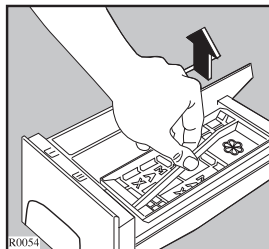
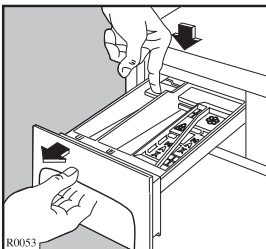

Detergent can also accumulate inside the drawer recess: clean it with an old toothbrush. Refit the drawer after cleaning.

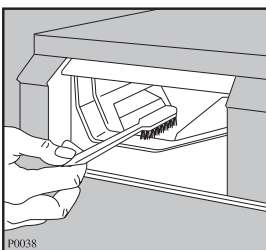

3. Cleaning of the drainage area

The drainage area must be cleaned if the pump has been blocked with objects such as buttons, safety pins, coins, etc. , or if lint has built up because clothes that generate lint have been washed at high temperatures.

- Pull out the plug from the power socket.
- If necessary, wait until the water has cooled down.
- Open the drainage area door.
- Place a bowl to collect the water.
- Release the emergency emptying hose, place it in the bowl and remove its cap, when the bowl is full put the cap back on the emergency emptying hose.
- Empty the bowl. Repeat the procedure until you have completely emptied the washing machine.

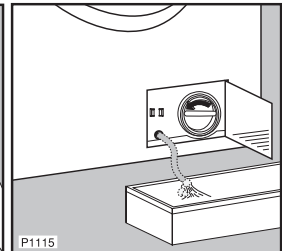
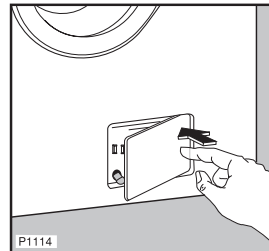

- To continue, unscrew the lid of the diaphragm by turning it counter clockwise and pull it out.
- Remove the objects such as buttons, coins and the lint that has been accumulated in the area of the pump impeller by rotating it.
- Screw the lid of the diaphragm clockwise, be sure is completely tighten.
- Replace the emergency emptying hose in its initial position and close the drainage area door.

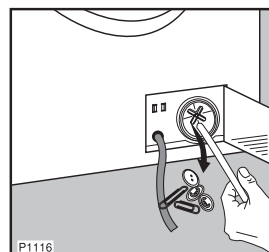

4. The water inlet hose filter

If your water is very hard or contains traces of lime deposit, the water inlet filter may become clogged.

It is therefore a good idea to clean it from time to time.

Turn off the water tap. Unscrew the water inlet hose.

Clean the filter using a hard bristle brush.

Tighten up the inlet hose.

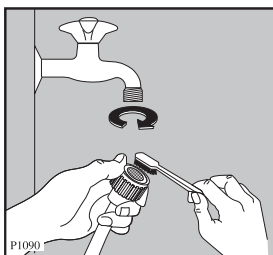

5. Emergency emptying out

If the water is not discharged (outlet pump is blocked, filter or drain hose are clogged), proceed as follows to empty out the machine:

- pull out the plug from the power socket;
- close the water tap;
- if necessary, wait until the water has cooled down;
- open the drainage area door;
- place a bowl to collect the water;
- release the emergency emptying hose, place it in the bowl and remove its cap, when the bowl is full put the cap back on the emergency emptying hose;
- empty the bowl, repeat the procedure until you have completely emptied the washing machine;
- replace the emergency emptying hose in its initial position and close the drainage area door.

6. Frost precautions

If the machine is installed in a place where the temperature could drop below 0°C, proceed as follows:

- disconnect the appliance;
- close the water tap;
- if necessary, wait until the water has cooled down;
- open the drainage area door;
- place a bowl to collect the water that will flow out;
- release the emergency emptying hose, place it in the bowl and remove its cap;
- when the water stops flowing out, put the cap back on the emergency emptying hose, replace the emergency emptying hose in its initial position and close the drainage area door.

By doing this, any water remaining in the machine is removed, avoiding the formation of ice and, consequently, breakage of the affected parts.

When you use the machine again, make sure that the ambient temperature is above 0°C.

Something not working?

Problems which you can resolve yourself.

Problem	Possible cause
<ul style="list-style-type: none"> • The machine does not start up: 	<ul style="list-style-type: none"> • The door is not firmly closed. • The machine is not plugged in or there is no power at the socket. • The main fuse has blown. • The programme selector is not positioned correctly or the programme selector knob has not been pulled out.
<ul style="list-style-type: none"> • The machine does not fill: 	<ul style="list-style-type: none"> • The water tap is closed. • The inlet hose is squashed or kinked. • The filter in the inlet hose is blocked. • The door is not properly closed.
<ul style="list-style-type: none"> • The machine fills then empties immediately: 	<ul style="list-style-type: none"> • The end of the drain hose is too low. Refer to relevant paragraph in “water drainage” section.
<ul style="list-style-type: none"> • The machine does not empty and/or does not spin: 	<ul style="list-style-type: none"> • The drain hose is squashed or kinked. • The option <input type="checkbox"/> has been selected. • The laundry is not evenly distributed in the drum. • The drainage area is blocked. Clean it.
<ul style="list-style-type: none"> • There is water on the floor: 	<ul style="list-style-type: none"> • Too much detergent or unsuitable detergent (creates too much foam) has been used. • Check whether there are any leaks from one of the inlet hose fittings. It is not always easy to see this as the water runs down the hose; check to see if it is damp. • The drain hose is damaged. • Check that the diaphragm lid is correctly screwed into place.
<ul style="list-style-type: none"> • Unsatisfactory washing results: 	<ul style="list-style-type: none"> • Too little detergent or unsuitable detergent has been used. • Stubborn stains have not been treated prior to washing. • The correct temperature was not selected. • Excessive laundry load.
<ul style="list-style-type: none"> • The machine vibrates or is noisy: 	<ul style="list-style-type: none"> • The transit bolts and packing have not been removed. • The support feet have not been adjusted. • The laundry is not evenly distributed in the drum. • Maybe there is very little laundry in the drum.
<ul style="list-style-type: none"> • The door will not open: 	<ul style="list-style-type: none"> • The programme is still running. • The door lock has not been released. • There is water in the drum.

If you are unable to identify or solve the problem, contact our service centre. Before telephoning, make a note of the model, serial number and purchase date of your machine: the Service Centre will require this information.

