

Handbook

CLiÉ™ handheld basic operations

Entering text on your CLiÉ™ handheld

Exchanging and updating files/data using the HotSync® operation

Customizing your CLiÉ™ handheld (Preferences)

Exchanging and updating files/data using the HotSync® operation (Other HotSync® operations)

Using storage media such as “Memory Stick™” media

Beaming

Using the Bluetooth® function

Using the Calculator and finding records

Backing up your CLiÉ™ handheld data and applications

Protecting your data with a password

Enhancing features with add-on applications

Transferring data from another CLiÉ™ handheld

CLiÉ™

Introduction

This Handbook explains the basic operations and useful features of your CLIÉ™ handheld.

Using your CLIÉ handheld for the first time

The basic features and operations are explained in detail (pages 9-69).

CLIÉ™ handheld basic operations

Explains the basic operations of your CLIÉ handheld and how to use the applications.

Entering text on your CLIÉ™ handheld

Explains how to enter text on your CLIÉ handheld.

Exchanging and updating files/data using the HotSync® operation

Explains how to use your CLIÉ handheld with your computer.

CLIÉ handheld advanced operations

Useful and advanced features to make full use of your CLIÉ handheld are explained in detail (pages 70-192).

Customizing your CLIÉ™ handheld (Preferences)

Explains how to customize your CLIÉ handheld in a way that suits you.

Exchanging and updating files/data using the HotSync® operation (Other HotSync® operations)

Explains the various methods of HotSync® operations.

Using storage media such as “Memory Stick™” media

Explains how to use files/data stored on storage media such as “Memory Stick” media.

Beaming

Explains how to exchange data or applications with another CLIÉ handheld by beaming.

Using the Bluetooth® function

Explains how to exchange files/data with another CLIÉ handheld using the Bluetooth® function.

Using the Calculator and finding records

Explains how to use the calculator and how to find records.

Backing up your CLIÉ™ handheld data and applications

Explains how to back up the data and applications of your CLIÉ handheld.

Protecting your data with a password

Explains how to assign a password to restrict the use of your CLIÉ handheld or to protect your data.

Enhancing features with add-on applications

Explains how to install additional applications on your CLIÉ handheld.

Transferring data from another CLIÉ™ handheld

Explains how to transfer data from your old CLIÉ handheld to your new CLIÉ handheld.

The following manuals are included with your CLIÉ handheld.
Refer to the following together with this manual.

Before you start using your CLIÉ handheld

Read This First (Operating Instructions)

Explains the following:

- Setting up your CLIÉ handheld and computer
- Basic operations
- What you can do with the applications

Be sure to read the supplied “Safety & Regulations Guide” to use your CLIÉ handheld safely.

- ↓
- When you want to become more familiar with the basic operations of your CLIÉ handheld
 - When you want to change the settings of your CLIÉ handheld

Handbook (This manual)

Using your CLIÉ handheld for the first time

The basic features and operations are explained in detail.

CLIÉ handheld advanced operations

Useful and advanced features to make full use of your CLIÉ handheld are explained in detail.

- ↓
- When you want to become more familiar with using the supplied applications
 - When you want to install additional applications

CLIÉ Application Manual (HTML format: Read via a computer window)

Explains how to use the supplied applications in detail.

For details on using this manual, refer to “Using the CLIÉ Application Manual” in the “Read This First (Operating Instructions)”.

- If you have problems

Troubleshooting Q&A

Helps in solving common problems that you may have while using your CLIÉ handheld.

Notes

- Some of the illustrations in this manual (Handbook) may not be consistent with your CLIÉ handheld.
 - ➔ For details on your CLIÉ handheld, refer to the “Read This First (Operating Instructions)”.
- Some of the accessories described in this manual (Handbook) may not be supported by your CLIÉ handheld.
- This manual supports PEG-UX50 and PEG-UX40.
 - The illustrations used in this manual are for PEG-UX50, unless specified otherwise.
 - Differences between PEG-UX50 and PEG-UX40 are specified in each corresponding section.

Table of Contents

CLIE™ handheld basic operations

Basic operations	10
Using the stylus	10
Using the Jog Dial™ navigator	12
Starting an application	14
Starting an application in the CLIE 3D Launcher	15
Quitting an application	16
Using CLIE 3D Launcher	17
Locating the components	17
CLIE 3D Launcher group	18
Using Favorite Applications (shortcuts)	22
Changing the CLIE 3D Launcher view	24
Displaying information about applications	25
Menu List	26
Using the Palm OS® Standard screen	27
Switching to the Palm OS® Standard screen	27
Starting an application	29
Changing the display style of the Palm OS® Standard screen	33
Displaying applications by category	35
Changing fonts	37
Common menu items	38

Continued on next page

Entering text on your CLIÉ™ handheld

Entering text on your CLIÉ™ handheld	40
Using Graffiti® 2 writing to enter text	41
What is Graffiti® 2?	41
Writing a stroke on your CLIÉ™ handheld	42
Using the Graffiti® 2 writing area	42
Graffiti® 2 character list.	44
Entering text	50
Using navigation strokes and shortcuts	52
Using Decuma Input to enter text.	54
Entering text	54
Using the on-screen keyboard to enter text	59
Entering text	59

Exchanging and updating files/data using the HotSync® operation

What is the HotSync® operation?	63
Performing the HotSync® operation	65
Performing the HotSync® operation with the USB cable (Local HotSync®)	65
Using Palm™ Desktop for CLIÉ.	67
Starting Palm™ Desktop for CLIÉ.	67
Locating components of Palm™ Desktop for CLIÉ	68
Basic operations of Palm™ Desktop for CLIÉ	69

Continued on next page

Customizing your CLIÉ™ handheld (Preferences)

What you can do with Preferences . . .	71
Setting the Bluetooth® function . . .	73
Turning the Bluetooth® function on or off	73
Viewing/Customizing Bluetooth® information	74
Displaying/Deleting the information of registered target Bluetooth® compatible devices	75
Setting the Graffiti® 2	76
Creating Graffiti® 2 ShortCuts	77
Adjusting the Digitizer	78
Setting the Network preferences for a wireless LAN (for PEG-UX50 only)	79
Setting a wireless LAN access point manually	79
Searching and setting a wireless LAN access point manually	81
Connecting your CLIÉ handheld to a wireless LAN access point automatically	82
Checking the wireless LAN communication status	83
Using the SSID menu	84
Setting the Network preferences for your provider and dial-up server . . .	85
Selecting a service template . . .	85
Entering a user name	85
Entering a password	86
Selecting a connection	86
Setting the telephone information	87
Adding detailed information to a service template	89
Duplicating/deleting additional service templates	91
Creating log-in scripts	92

Using the Network preferences menus	95
Assigning applications to application buttons	96
Customizing the full-screen pen stroke activities	97
Setting the automatic power-off time	98
Setting sounds	99
Turning the Alarm LED on or off . .	100
Turning the Beam Receive feature on or off	101
Selecting the screen color theme . .	102
Setting the display format for time, date, and numbers	103
Selecting a regional default . . .	103
Customizing your own settings . .	103
Changing the position of the Silk Screen area	104
Switching the keyboard-illumination	105
Starting applications by pressing the Ctrl key and a numeric key	106
Adding/Changing communication device preferences	107
Setting up the Date & Time preferences	108
Setting the date	108
Setting the time	108
Setting the time zone and daylight saving time	109
Setting the Phone function	110

Continued on next page

Exchanging and updating files/data using the HotSync® operation (Other HotSync® operations)

Customizing HotSync® application settings (Conduit)	112
Synchronizing with external data (File Link)	114
Customizing HotSync® Manager startup and HotSync® setup options	115
Performing the HotSync® operation via a wireless LAN (for PEG-UX50 only)	116
Performing the HotSync® operation using the Bluetooth® function	119
Performing the IR HotSync® operation	123
Performing the HotSync® operation via LAN (LANSync)	126

Using storage media such as “Memory Stick™” media

Using storage media such as “Memory Stick™” media	130
The type of storage media you can use with your CLIÉ handheld	130
Using “Memory Stick” media	130
Protecting the files/data on “Memory Stick” media	132
Starting an application on storage media	133
Viewing information of storage media (Card Info)	134
Assigning a name to “Memory Stick” media	135
Formatting “Memory Stick” media	136

Exchanging data via storage media	138
Starting CLIÉ Files	138
Copying your CLIÉ handheld data to storage media	140
Copying data on storage media to your CLIÉ handheld	143
Deleting files/directory on storage media	145
Extracting a Zip file	146
CLIÉ Files menu items	149
Exchanging files/data without using CLIÉ Files	150
Notes on starting applications from storage media	151

Beaming

Beaming between your CLIÉ handheld and another Palm OS® PDA	153
What you can do with beaming	153
Beaming information	154

Using the Bluetooth® function

Exchanging files/data using the Bluetooth® function	158
What you can do with the Bluetooth® function	158
Sending files/data, such as image files or Date Book data, to another CLIÉ handheld with the built-in Bluetooth® function or Bluetooth® Module (optional)	158
Performing the wireless HotSync® operation with a computer	159
Connecting to the Internet by communicating with a Bluetooth® compatible mobile phone	160

Continued on next page
.....

Using the Calculator and finding records

- Using the Calculator (Calc) 166
 - Making Calculations 166
 - The functions of the Calculator buttons. 167
 - Using the Calculator menus . . 168
- Finding records. 169
 - Using the Find option 169

Backing up your CLIÉ™ handheld data and applications

- Backing up your CLIÉ™ handheld data and applications 172
 - Backing up data and applications to your computer with the HotSync® operation 172

Protecting your data with a password

- Entering personal information . . . 174
- Locking your CLIÉ handheld with a password (Data protection). 176
 - Turning off your CLIÉ handheld after locking. 176
 - Setting your CLIÉ handheld to be locked automatically 178
- Protecting data. 179
 - Assigning a password 179
 - Changing or deleting a password. 180
 - Hiding or masking private data 181

Enhancing features with add-on applications

- Enhancing features with add-on applications. 183
- Installing 184
 - Installing from your computer. 184
 - Installing applications on storage media 186
 - Installing from the Internet. . . 186
 - Deleting installed add-on applications 187

Transferring data from another CLIÉ™ handheld

- Transferring data from another CLIÉ™ handheld 189
 - Transferring data using Palm™ Desktop for CLIÉ 189

INDEX 193

CLIE™ handheld basic operations

This chapter explains the basic operations of your CLIE handheld such as using the stylus and the Jog Dial™ navigator, locating components and starting applications.

This chapter also gives an overview of menus that are common to applications and explains how to select character fonts.

Basic operations	10
Starting an application	14
Using CLIE 3D Launcher	17
Using the Palm OS® Standard screen	27
Changing fonts	37
Common menu items	38

Basic operations

Operating using the stylus and the Jog Dial™ navigator.

Using the stylus

What is a stylus?

A stylus is a pen-like device for operating your CLIÉ handheld by directly touching the screen.

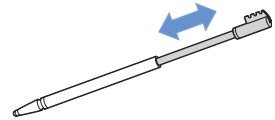

Tip

Where is the stylus located?

The stylus is stored in your CLIÉ handheld.

The exact storage location varies depending on your model.

- ➔ For details, refer to “CLIÉ™ handheld components” in the “Read This First (Operating Instructions)”.

Note

To prevent losing the stylus, always put it back in its holder on your CLIÉ handheld after use.

Continued on next page

You can operate your CLIÉ handheld using the stylus in the following ways.

Tapping

Lightly pressing the required item on the screen with the stylus is called “Tapping”. When entering text with the on-screen keyboard or starting an application, “tap” the desired button or icon with the stylus.

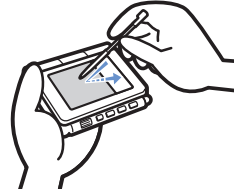

Dragging

Touching the required item on the screen with the stylus and moving it along the screen surface is called “Dragging”. Just as you “drag” the mouse on your computer, you can use the stylus to “drag” the scroll bar to scroll the screen, or to “drag” across characters to highlight them.

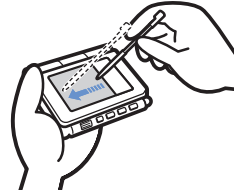

Using the Jog Dial™ navigator

What is the Jog Dial™ navigator?

Your CLIÉ handheld is equipped with a Jog Dial™ navigator, located on the front side of your CLIÉ handheld.

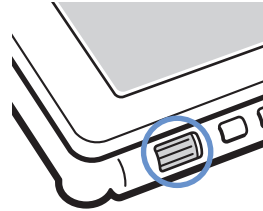

Rotating the Jog Dial™ navigator

Rotate the Jog Dial™ navigator to find the application you want to start.

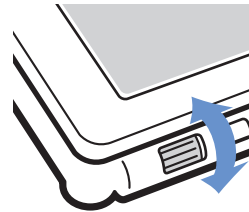

Continued on next page

Pressing the Jog Dial™ navigator

Press the Jog Dial™ navigator to select an item or to start a selected application.



Note

The operations you can perform using the Jog Dial™ navigator vary depending on the application.

- ➔ For details on the operations of each application, refer to the “CLÍÉ Application Manual” installed on your computer.

Tip

Rotating while pressing the Jog Dial™ navigator

In some applications, operations are executed by pressing and rotating the Jog Dial™ navigator.

Starting an application

A software that you can use on your CLIÉ handheld to execute a task, such as **Date Book**, **To Do List**, or e-mail software, is called an “application”. You need to start an application to operate your CLIÉ handheld.

Note

For details on starting applications from “Memory Stick” media (referred to as storage media), refer to page 133.

There may be some system limitations when starting applications that are stored on a storage media in the Home screen.

Tip

What is the Home screen?

The screen displayed when you turn on your CLIÉ handheld or tap  (Home), is called the Home screen. In your CLIÉ handheld, the CLIE 3D Launcher and the Palm OS Standard screen are installed as the Home screen. The screen specific to your CLIÉ handheld, the CLIE 3D Launcher, is displayed by default. The CLIE 3D Launcher is used in this manual as the Home screen.

Starting an application in the CLIE 3D Launcher

- 1 Tap  (Home).
The CLIE 3D Launcher is displayed.
- 2 Rotate the Jog Dial™ navigator to select an application icon and press the Jog Dial™ navigator to start the application.



Tip

You can also tap an application icon in the CLIE 3D Launcher to start the application.

Continued on next page

Quitting an application

You do not need to save data manually on your CLIÉ handheld as you do with the computer.

All the changes in the application that you are working on are automatically saved, and the last screen you worked on is displayed when you restart the application.

Display the CLIÉ 3D Launcher to switch to another application while you are working on an application.

You can select one of two methods to display the CLIÉ 3D Launcher as follows.

Return to the CLIÉ 3D Launcher by tapping  (Home).

Return to the CLIÉ 3D Launcher by pressing and holding the BACK button.

Tip

You can switch from one application to another by pressing the Application button.

Note

For some applications, you need to save data manually.

- ➔ For details, refer to the “CLIÉ Application Manual” installed on your computer.

Using CLIE 3D Launcher

Locating the components

Tip

Tap  (Home) to display the CLIE 3D Launcher if it is not displayed.

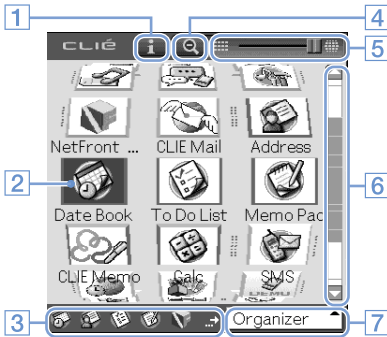

1 Information icon (page 18)

Tap to display the information for a selected application icon.

2 Application icons

3 Favorite Applications (shortcuts) (page 22)

You can create shortcuts to favorite applications.

4 Zoom In/Out icon (page 18)

Tap to change application icons to small or large.

5 3D Adjust bar (page 18)

Scroll the bar with the stylus to adjust the 3D degree.

6 Scroll bar

7 CLIE 3D Launcher group list (page 18)

The list of CLIE 3D Launcher groups is displayed.

CLIE 3D Launcher group

You can organize applications by group.

Note

Applications stored on storage media cannot be grouped.

Editing groups

1 Tap  (Home).
The CLIE 3D Launcher is displayed.

2 Tap  (Menu).
The menu is displayed.

3 Tap [Edit Group] from [CLIE 3D Launcher].
The **Group** screen is displayed.

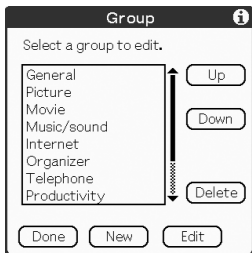

Note

CLIE 3D Launcher groups differ from Palm OS® Standard screen categories.

Continued on next page

4 Select a group to edit, and tap [Edit].

The display of the **Group** screen is changed.



Name: You can rename groups.

Ordering applications listed: Select an application and tap [Up] or [Down] to reposition applications in the CLIE 3D Launcher.

Adding applications: Tap [Add] to display the list, and select an application to add.

Removing applications: Select an application to be removed and tap [Remove]. Applications removed will be listed in the Unfiled group.

Note

The Unfiled group cannot be renamed.

5 Tap [Done].

The **Group** screen display returns.

6 Tap [Done].

The CLIE 3D Launcher is displayed.

Continued on next page



Ordering listed groups

1 Select a group on the **Group** screen.

2 tap [Up] or [Down].

The order of listed groups in the CLIE 3D Launcher is changed.

Creating a new group

1 Tap [New] on the **Group** screen.

The **New Group** screen is displayed.

2 Enter a new group name, and then tap [OK].



Note

Groups that do not include an application are not listed in the CLIE 3D Launcher.

Continued on next page

Deleting a group

- 1 Select a group you want to delete, and tap [Delete] on the **Group** screen.
If the group to be deleted includes any applications, the **Delete Group** dialog box will be displayed. In the dialog box, tap [Yes] to delete the group. The applications included in the deleted group will be listed in the Unfiled group.

Note



You cannot delete the Unfiled group.

Using the Scroll bar

Normally, the selection area moves from one application icon to another when you rotate the Jog Dial™ navigator. You can scroll each line of the CLIE 3D Launcher as follows.

- 1 Tap  (Home).
The CLIE 3D Launcher is displayed.
- 2 Press the BACK button.
You can now operate the scroll bar with the Jog Dial™ navigator.
- 3 Rotate the Jog Dial™ navigator to select a group.
If you press the Jog Dial™ navigator, the selection area moves to an application icon of the selected group.

Tips

- Applications saved on storage media will be listed in  (Card group) or  (Int.Media).
- You can select a group by tapping  (Home) repeatedly, or by tapping the CLIE 3D Launcher group list and selecting from the pop up list.



Using Favorite Applications (shortcuts)

You can create a Favorite Application (shortcut) for frequently used applications.

Note

You cannot create a Favorite Application (shortcut) for an application on storage media.

Creating a Favorite Application (shortcut)

- 1 Tap  (Home).
The CLIE 3D Launcher is displayed.
- 2 Tap  (Menu).
The menu is displayed.
- 3 Select [Edit Favorite Applications] from [CLIE 3D Launcher].
The **Favorite Application** screen is displayed.



Continued on next page

- 4 Tap a Favorite Application (shortcut) number that you want to assign to an application. The list of applications is displayed. Tap the application name to create a Favorite Application (shortcut).



Tip

You can create 10 shortcuts.

- 5 Tap [Done].

Note

When you delete an application that is saved as a shortcut, the shortcut is also automatically deleted from the Favorite Application list.

To delete a Favorite Application (shortcut)

In step 4, tap the Favorite Application (shortcut) number that you want to delete, and select **(None)** at the top of the list.

Changing the CLIE 3D Launcher view

You can change the size of application icons and adjust the 3D effect of the CLIE 3D Launcher.

Changing the size of application icons

1 Tap  (Home).
The CLIE 3D Launcher is displayed.

2 Tap .
Application icons are enlarged.

Tips

You can change the icon size back by tapping .





Adjusting the 3D effect of CLIE 3D Launcher

1 Tap  (Home).
The CLIE 3D Launcher is displayed.

2 Drag the slider of the 3D Adjust bar.
You can adjust the effect of CLIE 3D Launcher.



Displaying information about applications

- 1 Tap  (Home).
The CLIE 3D Launcher is displayed.
- 2 Rotate the Jog Dial™ navigator to select an application icon whose information you want to display.
- 3 Tap .
The **CLIE 3D Launcher Info** screen is displayed.
Tap [OK] to close the screen.



Editing a description

Tap [Edit] to display the **Edit Description** screen and enter the new description.



- [OK]: Changes to the description entered.
- [Cancel]: Cancels the description entered.
- [Default]: Restores the default description.

Menu List

The following list describes the functions of each menu in the CLIE 3D Launcher.

Menus in the CLIE 3D Launcher

Delete...	Deletes an application (page 187).
Beam...	Sends an application or data to another Palm OS PDA device via the IR port (page 153).
Send...	<p>Bluetooth: Sends an application or data to another Bluetooth[®] compliant Palm OS PDA device by wireless communication (page 158).</p> <p>SMS: Sends messages via a connected GSM wireless device, such as a mobile phone.</p>
<div style="background-color: #0056b3; color: white; padding: 2px 5px; display: inline-block;">Note</div> <p>Applications and data cannot be sent by SMS.</p>	
Edit Group	Edits a group of applications (page 18).
Edit Favorite Applications	Creates a shortcut to an application (page 22).
Info...	Displays the version, memory size, and the number of records of an application.
Copy...	Copies an application.



Options menu in the CLIE 3D Launcher

Preferences...	Makes settings for the CLIE 3D Launcher.
	<p>Show Expansion Cards</p> <p>Check the box to display the applications on the storage media (“Memory Stick” media or Internal Media) (Default: On).</p>
Go To Standard View	Switches to the Palm OS Standard screen (page 27).
About Applications	Displays version information of the application.

Using the Palm OS® Standard screen

Switching to the Palm OS® Standard screen

Your CLIE handheld is initially set to display the CLIE 3D Launcher when you tap  (Home). To switch to the Palm OS Standard screen, follow the procedure below.

- 1 Tap  (Home).
The CLIE 3D Launcher is displayed.
- 2 Tap  (Menu).
The menu is displayed.
- 3 Tap [Options].
The **Options** menu is displayed.
- 4 Tap [Go To Standard View] from [Options].
The screen will be switched to the Palm OS Standard screen.

Tap to display menus.

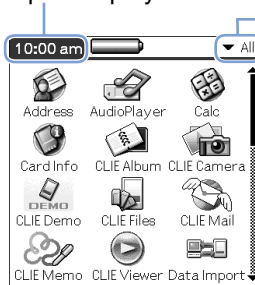

Tap to select a category to be displayed.

Tip

You can display categories in sequence by tapping  (Home).

Note

Palm OS Standard screen categories differ from CLIE 3D Launcher groups.

Continued on next page



Switching to the CLIE 3D Launcher

- 1 Tap  (Home).

The Palm OS® Standard screen is displayed.

- 2 Tap  (Menu).

The menu is displayed.

- 3 Tap [Options].

The **Options** menu is displayed.

- 4 Tap [Go To CLIE 3D Launcher View] from [Options].

The screen is switched to the CLIE 3D Launcher.

Starting an application

Note

For details on starting applications on storage media, refer to page 133.

There may be some system limitations when starting applications on storage media in the Palm OS Standard screen.

Starting an application with the Jog Dial™ navigator

- 1 Tap  (Home).

The Palm OS® Standard screen is displayed.

- 2 Rotate the Jog Dial™ navigator to select the application you want to start, then press the Jog Dial™ navigator.

The application starts.



Continued on next page

Changing the preferences of the start-up screen for the Jog Dial™ navigator operation

Set the preferences so that rotating the Jog Dial™ navigator displays a list of applications on the left side of the screen.

- 1 Tap  (Menu) on the Palm OS® Standard screen.

The menu is displayed.

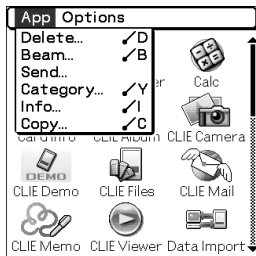

- 2 Tap [Options].

The **Options** menu is displayed.

- 3 Tap [Preferences] from [Options].

The **Preferences** screen is displayed.

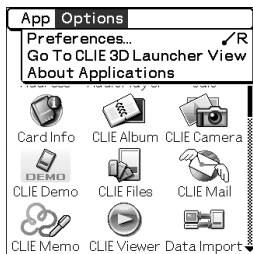

Continued on next page

4 Tap ▼ next to [Jog Select:], and select [PopUp].

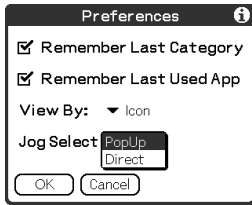

5 Tap [OK].

When the Jog Dial™ navigator is rotated, the list of applications is automatically displayed on the left of the screen.

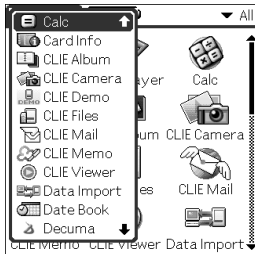

Continued on next page

Starting an application by tapping an application icon

- 1 Tap  (Home).
The Palm OS® Standard screen is displayed.

- 2 Tap the icon of the application you want to start.
The application starts.



Changing the display style of the Palm OS® Standard screen

On the Palm OS Standard screen, you can display applications in the list format or in the small-icon format. You can also choose to display your favorite category or last-used application when the Palm OS Standard screen is displayed.

The Icon (Small) view is displayed by default.

- 1 Tap  (Home).

The Palm OS® Standard screen is displayed.

- 2 Tap  (Menu).

The menu is displayed.

- 3 Tap [Options].

The **Options** menu is displayed.

- 4 Tap [Preferences] from [Options].

- 5 Tap ▼ next to [View By:], and select [List], [Icon], [List (Small)] or [Icon (Small)].

- 6 Tap [OK].

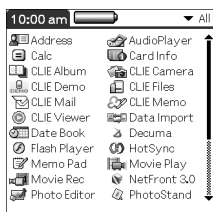

List view

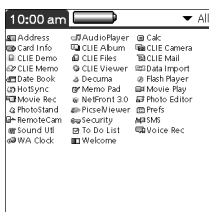

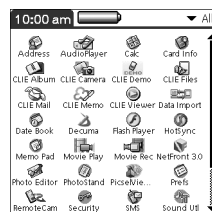

List (Small) view



Icon (Small) view

Continued on next page

Setting to display the last-opened category or the last-used application when the Palm OS Standard screen is displayed

- 1 Tap  (Home).
The Palm OS® Standard screen is displayed.
 - 2 Tap  (Menu).
The menu is displayed.
 - 3 Tap [Options].
The **Options** menu is displayed.
 - 4 Tap [Preferences] from [Options].
 - 5 Tap / (check boxes) next to [Remember Last Category] or [Remember Last Used App], to select the desired settings.
The check boxes are changed by tapping.
-
- 6 Tap [OK].

Tip

The check boxes are , in the default setting.

Note

Applications are not recognized as the last-used applications and categories in the following cases:

- Pressing an application button to start an application or category.
- Switching the screen from Palm OS Standard screen to CLIE 3D Launcher.

Displaying applications by category

You can choose to display applications by category.

Categorizing applications

-
- 1 Tap  (Home).
The Palm OS® Standard screen is displayed.

 - 2 Tap  (Menu).
The menu is displayed.

 - 3 Tap [App].
The **App** menu is displayed.

 - 4 Tap [Category...] from [App].
The **Category** screen is displayed.

 - 5 Tap ▼ next to each application, and select the category.

Note

To create a new category, tap ▼ at the top right of the Palm OS Standard screen, and then tap [Edit Categories...] to display the **Edit Categories...** screen.

Tap [New], enter a category name, and tap [OK]. Tap [OK] again when the new category is added.

-
- 6 Tap [Done].

Continued on next page

Displaying applications by category

1 Tap (Home).

The Palm OS® Standard screen is displayed.

2 Perform either of the following operations.

- Repeatedly tap  (Home) or repeatedly press the Jog Dial™ navigator to display the categories in sequence.
- Tap ▼ at the top right of the screen, and select the category you want to display.

Tip

If you select [All], all applications are displayed on the Palm OS Standard screen.

If you use the Jog Dial™ navigator often, it is convenient to select [All].

Note

CLIE 3D Launcher groups differ from Palm OS® Standard screen categories.

Changing fonts

You can change the font style in applications, such as **Date Book** or **Address Book**, according to your preferences. A font style can be assigned to each application.

1 Start an application whose font style you want to change.

2 Tap  (Menu).
The menu is displayed.

3 Tap [Options].
The **Options** menu is displayed.

4 Tap [Font...] from [Options].
The **Select Font** screen is displayed.

5 Tap the font style you want to use.

6 Tap [OK].
The text in the application is displayed in the font style you selected.

Note

Font style cannot be changed for some applications.

Common menu items

The following list describes functions that are common for your CLIÉ handheld applications, such as **Date Book**, **Address Book**, **To Do List**, and **Memo Pad**. To display the menu, tap  (Menu) while starting the application.

For menu items that are specific to an application, refer to the Menu description for each application.

Note

Some menus may not be displayed depending on the display style.

Edit Menu

Undo	Reverses the action of the last edit command. For example, if you used [Cut] to remove text, [Undo] restores the text you removed.
Cut	Removes the selected text and stores it temporarily in the memory of your CLIÉ handheld. You can paste the text you cut into another area of the current application or into other applications.
Copy	Copies the selected text and stores it temporarily in the memory of your CLIÉ handheld. You can paste the text you copied into another area of the current application or into other applications.
Paste	Inserts the text that you cut or copied at the selected point. If you did not previously cut or copy text, paste has no effect.
Select All	Selects all of the text in the current record or screen. This function enables you to cut or copy all of the text and paste it at the selected point.
Keyboard	Opens the on-screen keyboard.
Graffiti 2 Help	Opens the list of Graffiti [®] 2 character strokes. You can view the required stroke order for characters as needed.



Entering text on your CLIÉ™ handheld

This chapter explains how to enter text on your CLIÉ handheld.

Entering text on your CLIÉ™ handheld	40
Using Graffiti® 2 writing to enter text	41
Using Decuma Input to enter text	54
Using the on-screen keyboard to enter text	59

Entering text on your CLIÉ™ handheld

You can enter text by the following methods, other than the hardware keyboard.

Handwriting input system

Graffiti® 2 (page 41)

Enter text using the freehand input characters, called Graffiti 2. Once you get used to entering text using Graffiti 2, it is much faster than entering text with the on-screen keyboard.



Decuma Input (page 54)

Decuma Input converts your handwriting into typed text and can be used to input text with any application. Simply write in the input area in the lower part of the screen. The interpretation of your handwriting is displayed in the same place you write.

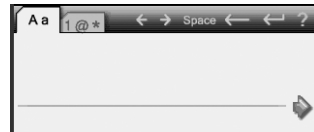

On-screen keyboard (Input panel) (page 59)

Enter text by tapping the keyboard displayed on the screen.

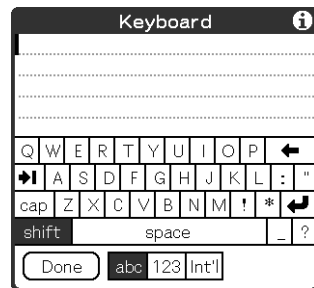

Using Graffiti® 2 writing to enter text

This section describes the procedures for creating letters, numbers, punctuation marks and symbols, and teaches you some Graffiti® 2 tips and tricks.

What is Graffiti® 2?

Graffiti® 2 is a unique writing method for quickly and easily entering text into CLIE applications. Text is entered in the Graffiti® 2 area using the stylus. Graffiti® 2 recognizes your handwriting and immediately converts it to typed text.



Displaying the on-screen Graffiti 2 Help

Drag the stylus to the other end of the screen from the Graffiti® 2 writing area. Graffiti 2 Help opens a series of screens that show the character set of Graffiti® 2 writing.

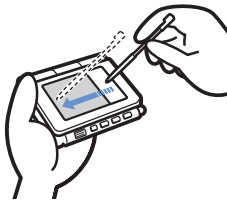

Tip

You can customize the way you write the characters t, p, y, and \$. For details, refer to “Setting the Graffiti® 2” on page 76.

Writing a stroke on your CLIÉ™ handheld

The dot on each stroke shows where to begin the stroke

Certain characters have similar stroke shapes, but different beginning and end points. Always begin each stroke from the dot and lift the stylus at the end.

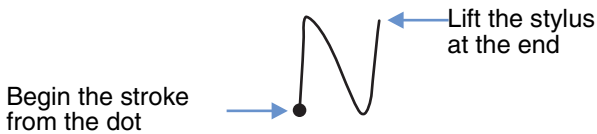

Note

You do not need to create the dot when you actually write a stroke. It is only shown in this manual to illustrate where to begin the stroke.

Using the Graffiti[®] 2 writing area

The Graffiti[®] 2 writing area is divided into two halves: one for writing the lower case letters of the alphabet and one for writing numbers. The area around the division line is used for writing upper case letters of the alphabet.

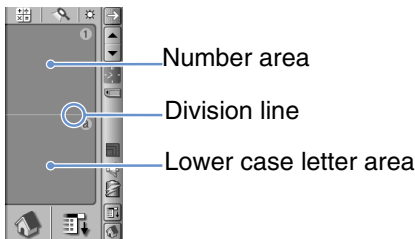

Writing upper case letters

To enter an upper case letter, write the stroke(s) across the division line of the Graffiti[®] 2 writing area*.

* Memo Pad is used as an example application in this manual.

Continued on next page

Write the stroke(s) across the division line

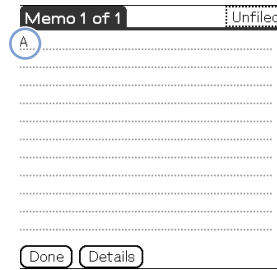
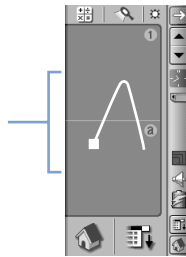

Writing lower case letters

To enter a lower case letter, write the stroke(s) on the Lower case letter area of the Graffiti® 2 writing area.

Write the stroke(s) within this area

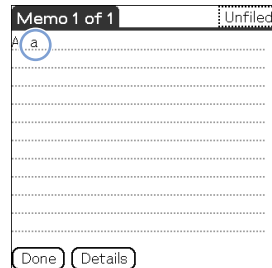
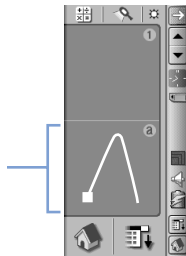

Writing numbers

To enter a number, write the stroke(s) on the Number area of the Graffiti® 2 writing area.

Write the stroke(s) within this area

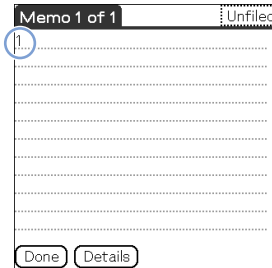
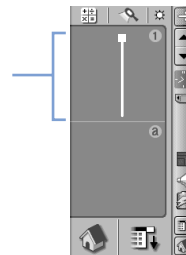

Graffiti® 2 character list

Alphabet

A	Λ A A A a	N	N N n
B	B B b b	O	O O
C	C	P	P P
D	D D d d	Q	q q q q
E	E E	R	R R r
F	F F f f ² f ¹	S	S
G	G G g g	T	t ² †
H	h h H	U	U U
I	i ¹ i ²	V	V V
J	J J j j ² j ¹ j ²	W	W
K	k ¹ k ²	X	x ¹ x ²
L	L I	Y	y y
M	m m	Z	Z z

Numbers

1	1 1	6	6
2	2 2	7	7
3	3	8	8 8
4	4 ¹ 4 ² 4 4	9	9 9
5	5 5 ¹ 5 ²	0	O O

Continued on next page

Writing symbols

To enter a symbol, activate Symbol mode. In Symbol mode, you can write on the Lower case letter area or the Number area of the Graffiti® 2 writing area. Follow the steps below to enter a symbol.

1 Write the stroke | anywhere within the Graffiti® 2 writing area.

The Punctuation Shift indicator is displayed on the screen to show that you are in Symbol mode.

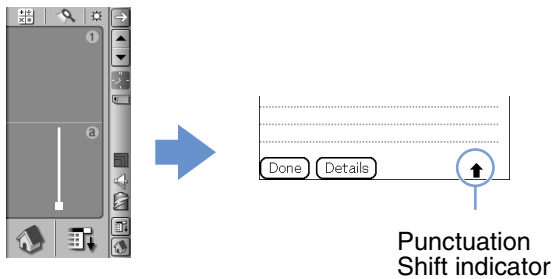

Tip

You can write the stroke |, to enter Symbol mode or exit Symbol mode, on either the Lower case letter area or the Number area.

2 Write the symbol stroke(s).



Continued on next page

Tip

- Write the stroke(s) as soon as you enter Symbol mode before Symbol mode automatically exits.
- You can write the stroke(s) anywhere in the Graffiti® 2 input area when Symbol mode is activated.

3 Write the stroke | again.

This will enter the symbol, and exit Symbol mode.





Tips

Some symbols can be entered without activating Symbol mode. You need to write the stroke(s) on the Lower case letter area or the Number area of the Graffiti® 2 writing area, depending on the symbol. For details, refer to Graffiti 2 Help on your CLIÉ handheld. This shows which symbols need to be written on the Lower case letter area of the Graffiti® 2 writing area, and which need to be written on the Number area.

Continued on next page

Symbol (Lower case letter area)

You can write the following stroke(s) directly in the Lower case letter area without switching to Symbol mode.

. (Period)	•	@	
, (Comma)	┘	"	┘┘
' (Apostrophe)	┘	Space	—
? (Question mark)	¹ ┘ ₂ •	Carriage return	↵
! (Exclamation mark)	¹ ┘ ₂ •	Tab	┘
&			

Symbol (Number area)

You can write the following stroke(s) directly in the Number area without switching to Symbol mode.

. (Period)	•	\ (Back slash)	↘
, (Comma)	┘	/ (Slash)	↙
~ (Tilde)		((Left paren)	(
-	—) (Right paren))
+	² ┘ ₁ ┘	=	==
*	² ┘ ₁ ┘		

Continued on next page

Symbol (Symbol mode)

You can input the following symbols in Symbol mode.

. (Period)	•	((Left paren)	(
, (Comma)	,) (Right paren))
' (Apostrophe)	'	<	<
? (Question mark)	?	>	>
! (Exclamation mark)	!	[[
&	&]]
@	@	{	{
\$	\$	}	}
~ (Tilde)	~	+	+
/ (Slash)	/	-	-
\ (Back slash)	\	*	*
"	"	÷	÷
;	;	=	=
:	:	#	#
_	_	%	%
		^	^
'	'	`	`
'	'	™	™
“	“	®	®
”	”	©	©

Continued on next page

Using Graffiti® 2 writing to enter text

§		ı	
•		°	
¢		ß	
€		μ	
¥		f	
£		ø	
ı			

Writing accented letters

To enter an accented letter, first write the lower case letter or upper case letter, then write the accent stroke on the Number area of the Graffiti® 2 writing area. For details, refer to the following and Graffiti 2 Help on your CLIÉ handheld.

à è ì ò ù		á é í ó ú ý	
â ê î ô û		ã õ ñ	
ä ï ö ü ÿ		å	

Entering text

To enter text, you will need software (an application) that is compatible with your CLIE handheld. Follow the steps below to enter text using **Date Book**.

- 1 Tap  (Date Book) on the CLIE 3D Launcher. **Date Book** starts. Today's schedule is displayed.

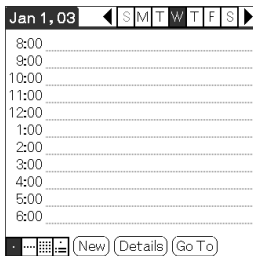

- 2 Tap the time line in the **Date Book** screen.

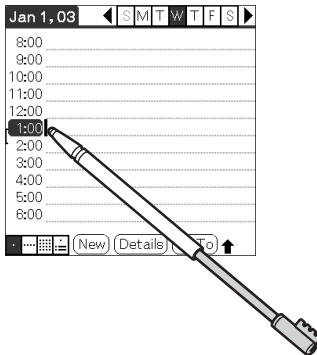

Continued on next page

- 3 Use the tables on the previous pages to find the stroke shape for the letter you want to create. There are several different stroke shapes available for some letters. For those letters, choose the one that is easier for you. You use the same shape to create both the upper case and lower case version of a letter.

- 4 Position the stylus on the Lower case letter area of the Graffiti 2 writing area. Start your stroke at the dot and draw the stroke shape as it is displayed in the tables.

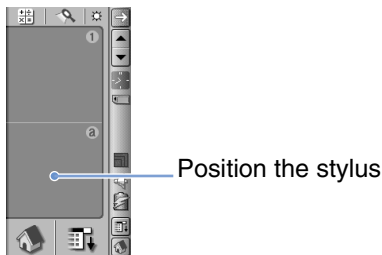

Note

You must begin the character strokes in the Graffiti 2 writing area. If you do not make Graffiti 2 strokes in the Graffiti 2 writing area, your CLIÉ handheld does not recognize them as text characters.







Notes on writing Graffiti 2 characters

- Recognition accuracy improves when you write large characters. You should draw strokes that nearly fill the Graffiti 2 writing area.
- Write at natural speed. Writing too slowly can generate recognition errors.
- Do not write on a slant. Vertical strokes should be parallel to the sides of the Graffiti 2 writing area.

Using navigation strokes and shortcuts

Using navigation strokes

When you are entering text or operating an application, you can use navigation strokes within the field of the application. For details, refer to the following and Graffiti 2 Help on your CLIÉ handheld.

Back Space		Punctuation Shift	
Cut		Copy	
Paste		Undo	
Menu Command*			





*Certain function icons, such as Copy and Delete, will display only when that function is available.

Note

If the letter “L” is registered as a menu command for an application, the letters “K”, “T”, “I”, and “X” will not work as menu commands. This is because the first stroke of these two-stroke letters will be mistakenly recognized as the command “L”. If there is no command “L,” any or all of the four letters can be registered as menu commands.

Continued on next page

Using shortcuts

Default shortcuts are registered on your CLIÉ handheld. To use a shortcut, write the shortcut stroke  followed by the shortcut characters. When you write the shortcut stroke, the Short Cut Shift indicator is displayed at the insertion point to show that you are in Shortcut mode. For example, if you write the Graffiti® 2 writer shortcut “ds” (, , and ) in the Graffiti® 2 writing area, this enters the current date and time. For details, refer to the following.

The following are the Graffiti 2 Shortcuts that are registered on your CLIÉ handheld:

Date stamp	ds	Breakfast	br
Time stamp	ts	Lunch	lu
Date/time stamps	dts	Dinner	di
Meeting	me		

Tips

- You can also enter shortcuts by using Symbol mode.
- You can also create your own shortcuts. For details, refer to “Customizing your CLIÉ™ handheld (Preferences): Creating Graffiti® ShortCuts”.

Using Decuma Input to enter text

Decuma Input converts your handwriting into typed text and can be used to input text with any application. Simply write in the input area. The interpretation of your handwriting is displayed in the same place you write.

Entering text

To enter text, you will need software (an application) that is compatible with your CLIE handheld. Follow the steps below to practice entering text using **Date Book**.

- 1 Tap  (Date Book) on the CLIE 3D Launcher. **Date Book** starts. Today's schedule is displayed.

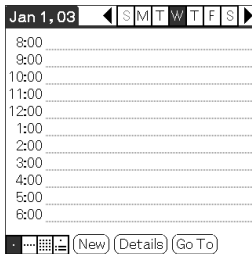

- 2 Tap the time line on the **Date Book** screen.

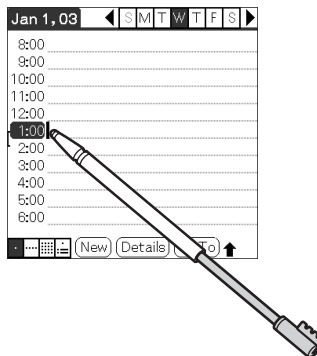

Continued on next page

- 3 Tap **a** on the Graffiti 2 input area.
The **Decuma Input** screen is displayed.

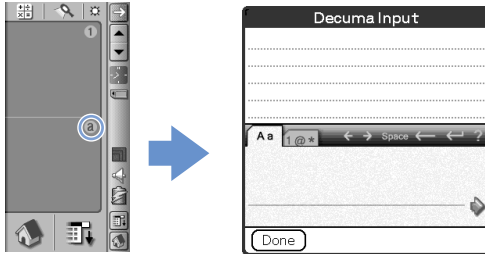

Tip

You can also display the Decuma Input screen by tapping **1** on the Graffiti 2 input area. In this case, the Decuma Input screen for Numbers and Special characters is displayed.

For details, refer to “The areas for writing letters and numbers are different” on page 57.

- 4 Write on the baseline of the input area.

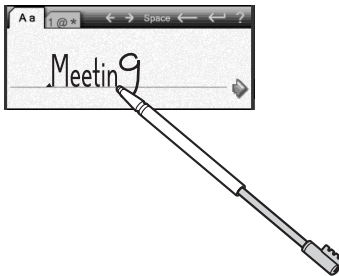

Tip

Write as you normally would.

Continued on next page

5 Tap ► at the end of the baseline.

The typed text is inserted in the top of **Decuma Input** screen.

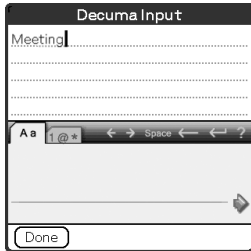

6 Tap [Done].

The typed text is inserted in the **Date Book** screen.

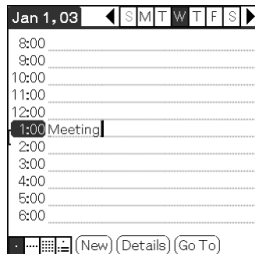

Continued on next page

The areas for writing letters and numbers are different

Your handwriting can be recognized in two different modes: as general characters, and as numbers and special characters.



General characters mode

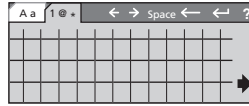

Numbers and special characters mode

Other input operations

←, →: Moves the cursor

Space: Inserts a space

←: Deletes the last character

↵: Starts a new line behind the cursor

?: Displays the **Decuma Latin** help screen

Tip

You can drag the stylus to the other end of the screen from the Graffiti 2 Input area, to display the **Decuma Latin** help screen.

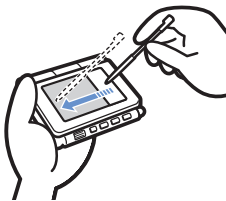

Continued on next page

Changing the Decuma Input settings

- 1 Tap  (Decuma) on the CLIE 3D Launcher. The **Decuma** screen is displayed.

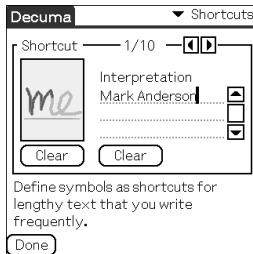

- 2 Tap ▼ at the top right of the screen, and select the desired settings.

Shortcuts:

Defines shortcuts for lengthy text that you write frequently.

Personalize:

Edits the Decuma alphabet to adjust individual characters for improved recognition.

Settings:

Customizes Decuma Input's features.

Info:

Displays the version of Decuma Input on your CLIE handheld.

Using the on-screen keyboard to enter text

You can enter text using the stylus of your CLIÉ handheld.

Entering text

To enter text, you will need software (an application) that is compatible with your CLIÉ handheld. Follow the steps below to practice entering text using **Date Book**.

- 1 Tap  (Date Book) on the CLIE 3D Launcher. **Date Book** starts. Today's schedule is displayed.

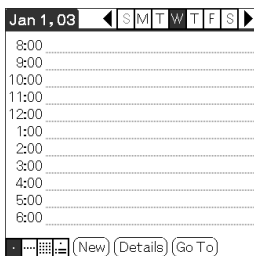

- 2 Tap the time line on the **Date Book** screen.

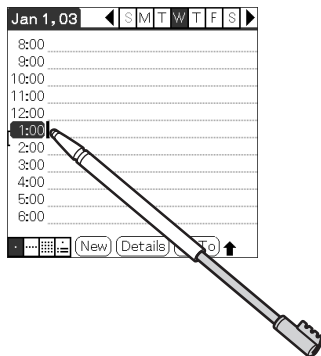

Continued on next page

3 Tap  (Menu).

The menu is displayed.

4 Tap [Edit], and select [Keyboard].

The keyboard screen is displayed.

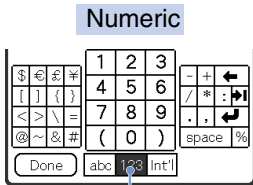
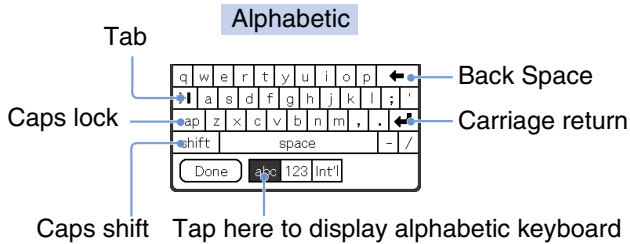

Tap here to display the numeric keyboard



Tap here to display the international keyboard

5 Select the required keyboard and tap the characters to enter text and numbers.

You can use the on-screen keyboard in the same way as your computer's keyboard. To enter a capital letter, tap "cap" and then tap the character button. To delete a character, tap .

Continued on next page

6 When you have finished entering the text, tap [Done].

The keyboard screen is closed, and the typed text is inserted in the **Date Book** screen.

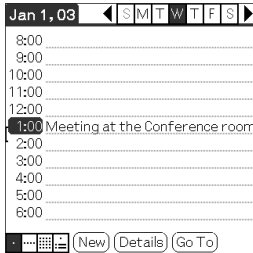



Exchanging and updating files/data using the HotSync[®] operation

This chapter explains how to perform the HotSync[®] operation with your computer.

What is the HotSync[®] operation?	63
Performing the HotSync[®] operation	65
Using Palm[™] Desktop for CLIÉ	67

What is the HotSync® operation?

The HotSync® operation is a one-step operation that enables you to synchronize files/data between your CLIÉ handheld and your computer. With just one press of the HotSync button, you can synchronize your CLIÉ handheld application files/data with **Palm™ Desktop for CLIÉ** files/data on your computer, back up the files/data of your CLIÉ handheld on your computer, and install add-on applications.

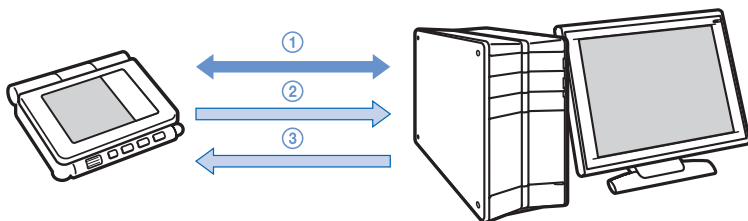

① Synchronizing the files/data between your CLIÉ handheld and your computer

Synchronizes the data of **Date Book**, **Address Book**, **To Do List**, and **Memo Pad** between your CLIÉ handheld and your computer. You can manage the files/data of multiple CLIÉ handhelds separately using **Palm™ Desktop for CLIÉ**.

② Saving backup data or applications on your computer

Automatically creates a backup of the data or applications currently held in your CLIÉ handheld to your computer. If you delete data or applications by accident, or if you need to perform a hard reset, the HotSync® operation allows you to restore the data or applications using the backup data or applications on your computer.

For details on backing up data and applications, refer to page 172.

Continued on next page

③ Using the files/data created in Microsoft® Windows® applications in your CLIÉ handheld

Imports or exports the files/data between a Windows software on your computer and your CLIÉ handheld.

The compatible file formats that you can import/export to the Palm™ Desktop for CLIÉ

- Comma/Tab delimited (*.csv, *.txt, *.tab, *.tsv)
- Text file (*.txt)
- vCal (Date Book) file (*.vcs)
- vCard (Address) file (*.vcf)
- Date Book archive of Palm™ Desktop for CLIÉ (*.dba)
- Address Book archive of Palm™ Desktop for CLIÉ (*.aba)
- To Do List archive of Palm™ Desktop for CLIÉ (*.tda)
- Memo Pad archive of Palm™ Desktop for CLIÉ (*.mpa)

* The words in parentheses are file extensions. Archive is a unit that gathers associated files.

➔ For details on importing/exporting files/data, refer to the online help of Palm™ Desktop for CLIÉ.

Performing the HotSync[®] operation

To perform the HotSync[®] operation, **Palm™ Desktop for CLIÉ** must be installed on your computer.

- ➔ For details on the HotSync[®] operation, refer to “Using your CLIÉ™ handheld with your computer” in the “Read This First (Operating Instructions)”.

Performing the HotSync[®] operation with the USB cable (Local HotSync[®])

Performing the HotSync[®] operation with the USB cable supplied with your CLIÉ™ handheld is called a Local HotSync[®].

1 Connect your CLIÉ handheld to your computer with the USB cable supplied with your CLIÉ handheld.

2 Tap  (Home).
The CLIE 3D Launcher is displayed.

3 Rotate the Jog Dial™ navigator to select  (HotSync), and then press the Jog Dial™ navigator.
The HotSync screen is displayed.

Tip

You can tap  (HotSync) on the CLIE 3D Launcher to display the HotSync screen.

4 Tap  (HotSync).
The HotSync[®] operation starts.

Continued on next page

Performing the HotSync® operation



When the HotSync® operation is complete, a message showing the HotSync® completion is displayed on your CLIÉ handheld.

Note

Do not disconnect your CLIÉ handheld from your computer until the HotSync® operation is complete. Also, do not insert or remove “Memory Stick” media while the HotSync® operation is being performed. Otherwise, **Palm™ Desktop for CLIÉ** may not finish normally.

If the HotSync® operation does not start

Make sure that  (HotSync) is displayed in the Windows task tray (Notification area).

If  (HotSync) is not displayed in the task tray (Notification area), click [Start], select [Programs] (for Windows XP, select [All Programs]), [Sony Handheld], and click [HotSync Manager]. Check that  (HotSync) is displayed in the task tray (Notification area) and tap  (HotSync) on the screen of your CLIÉ handheld to start the HotSync® operation.

The message is displayed on your computer window when the HotSync® operation starts.

* From this point onwards, where Windows XP Home Edition and Windows XP Professional are common, they will both be referred to as Windows XP.

**In Windows XP, the task tray is called “Notification area”.

In this manual, it is written as “task tray (Notification area)”.

Tip

If you cannot perform the HotSync® operation

Refer to the “Troubleshooting Q&A”.

Using Palm™ Desktop for CLIÉ

Palm™ Desktop for CLIÉ enables you to view the data transferred from your CLIÉ handheld by the HotSync® operation, on your computer.

Additionally, **Palm™ Desktop for CLIÉ** has the same functions as **Date Book**, **Address Book**, **To Do List**, and **Memo Pad** so that you can enter or modify schedules or address book data on your computer and export data to your CLIÉ handheld.

Starting Palm™ Desktop for CLIÉ

- 1 Double-click  (Palm Desktop for CLIÉ) on the Windows desktop.
You can also click [Start], select [Programs] (for Windows XP, select [All Programs]), [Sony Handheld], and click [Palm Desktop for CLIÉ].
Palm™ Desktop for CLIÉ starts.

Tip

To quit Palm™ Desktop for CLIÉ

Click  at the top right of the window or select [Exit] from the **File** menu.

Locating components of Palm™ Desktop for CLIÉ

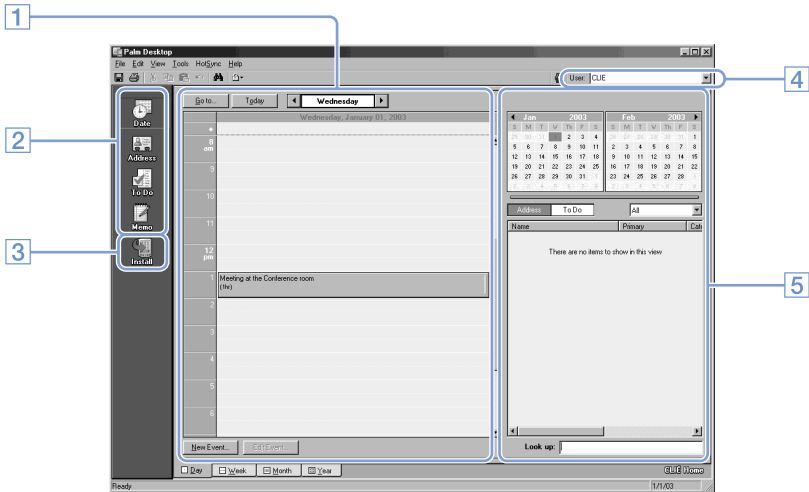

1 List pane

Displays the records in the current Desktop application.

2 Application Launch bar

Click an icon to open the associated application.

3 Install icon

Click this icon to display the **Install Tool** dialog box. You can install applications onto your CLIÉ handheld with the HotSync® operation.

➔ For details, refer to “Installing” on page 184.

4 User selector

Displays the user name of the current information.

5 Record pane

Displays full details of the record that is selected in the List pane. The information displayed here is the same as that displayed on your CLIÉ handheld’s **Details** screen.

Basic operations of Palm™ Desktop for CLIÉ

Click the icon of the application you want to use. The window switches to the selected application window.

Basic operations for each application are the same as those of the corresponding CLIÉ handheld application.

- ➔ For details on operations, refer to the online help of **Palm™ Desktop for CLIÉ**. To display the online help, select [Palm™ Desktop Help] from [HELP].

Tip

Changing the user name of your CLIÉ handheld

- ① **In the Palm™ Desktop for CLIÉ window, click [Users] from the Tools menu.**
The **Users** dialog box is displayed.
- ② **Click the user name you want to change and click [Rename].**
- ③ **Enter a new user name and click [OK].**
Your CLIÉ handheld user name is changed at the next HotSync® operation.

When using the Microsoft® Windows® XP operating system

When you start Palm™ Desktop for CLIÉ software on your computer, and select [Custom], [File Link], [View Log], or [Setup] from [HotSync], the configuration window may open behind **Palm™ Desktop for CLIÉ** window.

In this case, bring the configuration window to the front by performing one of the following:

- Press the Alt and Tab keys at the same time.
- Click  (HotSync) at the bottom right of the Windows task tray (Notification area).

Customizing your CLIE™ handheld (Preferences)

This chapter explains how to customize your CLIE handheld by changing the Preferences settings.

What you can do with Preferences	71
Setting the Bluetooth® function	73
Setting the Graffiti® 2	76
Creating Graffiti® 2 ShortCuts	77
Adjusting the Digitizer	78
Setting the Network preferences for a wireless LAN (for PEG-UX50 only)	79
Setting the Network preferences for your provider and dial-up server	85
Assigning applications to application buttons . .	96
Customizing the full-screen pen stroke activities	97
Setting the automatic power-off time	98
Setting sounds	99
Turning the Alarm LED on or off	100
Turning the Beam Receive feature on or off . .	101
Selecting the screen color theme	102
Setting the display format for time, date, and numbers	103
Changing the position of the Silk Screen area .	104
Switching the keyboard-illumination	105
Starting applications by pressing the Ctrl key and numeral key	106
Adding/Changing communication device preferences	107
Setting up the Date & Time preferences	108
Setting the Phone function	110

What you can do with Preferences

The **Preferences** screen enables you to customize the configuration options on your CLIÉ handheld.

Setting options may be added by installing new application or software for peripheral devices.

Settings	Details
Bluetooth	Sets the configuration for the Bluetooth [®] function. ➔ For details, refer to page 73.
Buttons	Customizes applications assigned to application buttons, and the full-screen pen stroke operation. ➔ For details, refer to pages 96 to 97.
Connection	Sets the configuration for the communication device. ➔ For details, refer to page 107.
Date & Time	Sets the current date, time, time zone and daylight saving configuration. ➔ For details, refer to page 108.
Digitizer	Calibrates the screen of your CLIÉ handheld. ➔ For details, refer to page 78.
Extension	Sets the position of the Silk Screen area, the keyboard illumination ON or OFF, and assigned applications to be started by pressing the Ctrl key and numeric keys ➔ For details, refer to page 103.
Formats	Sets the formats for time, date, or numbers. ➔ For details, refer to page 103.
General	Sets the configurations for auto shut-off interval, system sound, LED feature, and display color theme. ➔ For details, refer to pages 98 to 101.
Graffiti 2	Sets alternate forms of writing the characters T, P, Y, and \$. ➔ For details, refer to page 76.
Network	Sets the Internet connection configuration. ➔ For details, refer to page 85.
Owner	Sets the owner information, such as name and phone number. ➔ For details, refer to page 174.
Phone	Sets the connection configuration with GSM phone and the model of GSM phone. ➔ For details, refer to page 110.
Power Saving	Sets the Power Saving Mode.
ShortCuts	Defines a list of Graffiti [®] 2 abbreviations. ➔ For details, refer to page 77.

Continued on next page

Displaying the Preferences screen for each menu

- 1 Rotate the Jog Dial™ navigator to select  (Prefs) on the CLIE 3D Launcher and press the Jog Dial™ navigator. The **Preferences** screen is displayed.

Tip

You can also tap the Prefs icon to display the **Preferences** screen.

- 2 Tap ▼ at the top right of the screen, and select the Preferences menu you want to configure.

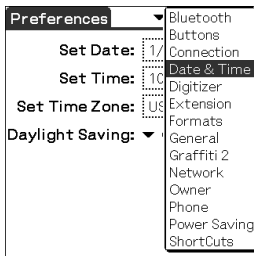

Setting the Bluetooth® function

Note

You cannot use the Bluetooth® function while the **Preferences** screen for Bluetooth is displayed.

Turning the Bluetooth® function on or off

You can turn the Bluetooth® function on or off.

You cannot receive data via the Bluetooth® function when it is disabled. By default, the Bluetooth® function is disabled to conserve your CLIÉ handheld's battery.

- 1 Tap ▼ at the top right of the **Preferences** screen, and select [Bluetooth].

The **Preferences** screen for Bluetooth is displayed and the Bluetooth LED lights up.

- 2 Tap ▼ next to [Bluetooth:], and select [Enabled] or [Disabled].

- **Enabled:** Turns on the Bluetooth® function. The Bluetooth LED lights up or blinks.
- **Disabled:** Turns off the Bluetooth® function.

Note

Bluetooth LED remains lit when the **Preferences** screen for Bluetooth is displayed.

Viewing/Customizing Bluetooth® information

You can set the Bluetooth® function with the following items displayed on the **Preferences** screen for Bluetooth:

Device name	You can enter a name for your CLIÉ handheld. A device name is required for each CLIÉ handheld to be identified. You can display the Edit Device Name dialog box by tapping the square box.
Allow Device to be Discovered	Yes: Another Bluetooth® compatible device detects your CLIÉ handheld as a target Bluetooth® compatible device. No: Another Bluetooth® compatible device does not detect your CLIÉ handheld as a target Bluetooth® compatible device. (Default: Yes)
Allow Wake Up	Yes: Another Bluetooth® compatible device can turn on your CLIÉ handheld automatically and detect your CLIÉ handheld as a target Bluetooth® compatible device when your CLIÉ handheld is turned off. (The Bluetooth LED blinks while this feature is enabled). No: Another Bluetooth® compatible device cannot detect your CLIÉ handheld as a target Bluetooth® compatible device when your CLIÉ handheld is turned off. (Default: No)
Device Address	You can display the device address (identification number of Bluetooth® device) of your CLIÉ handheld. The device address cannot be edited.

You can change your device name cache settings by tapping  (Menu) on the **Preferences** screen for Bluetooth.

Tap **Enable device name cache** or **Disable device name cache**.

Enable device name cache	The list of device names registered on your CLIÉ handheld is displayed. The most current device names might not be displayed. (The name list will be updated after you connect to the Bluetooth® compatible device).
Disable device name cache	Another Bluetooth® compatible device will be detected whether or not that device name is registered on your CLIÉ handheld. Discovery will be slower, but the most current device names will be displayed. (Default: Enable device name cache)

..... **Displaying/Deleting the information of registered target Bluetooth® compatible devices**

You can view information of Bluetooth® compatible devices registered on your CLIÉ handheld or delete devices from Trusted Devices list.

- 1** Tap ▼ at the top right of the **Preferences** screen, and select [Bluetooth].
The **Preferences** screen for Bluetooth is displayed.
- 2** Tap [Trusted Devices].
The Bluetooth® compatible devices registered on your CLIÉ handheld are displayed.
- 3** Select the device whose information you want to display, and tap [Details...].
The **Device Details** dialog box is displayed.
Tap [Done] to return to the **Trusted Devices** screen.
- 4** To delete the selected device, tap [Delete Device].
When the confirmation dialog box is displayed, tap [OK].
- 5** Tap [Done] to return to the **Preferences** screen for Bluetooth.

Adding target Bluetooth® compatible devices to list of Trusted Devices

Tap [Add Device] in the **Trusted Devices** dialog box and follow the on-screen instructions.

Setting the Graffiti® 2

You can select alternate forms of writing the characters T, P, Y, and \$ on your CLIÉ handheld.

For example, to select an alternate way to write the character T:

- 1** Tap ▼ at the top right of the **Preferences** screen, and select [Graffiti 2].
- 2** Tap [t].
The **Graffiti 2 Tuner** screen is displayed.
- 3** To confirm the displayed method of writing the letter T, tap next to [Use this form of 't'.] to change to .
- 4** Tap [Done].

Tip

You can change the way you write the character P, Y, and \$ in the same way.

Note

When an alternate method of writing the selected character is selected, your CLIÉ handheld will not recognize the default method of writing that character.

Creating Graffiti® 2 ShortCuts

You can create abbreviations (ShortCuts) for entering text with Graffiti® 2 strokes.

► For details on using Graffiti® 2 ShortCuts, refer to “Using Shortcuts” on page 53.

- 1** Tap ▼ at the top right of the **Preferences** screen, and select [ShortCuts].
- 2** Tap [New].
The **ShortCut Entry** screen is displayed.
- 3** Enter [ShortCut Name:] (abbreviation) and [ShortCut Text:] (character string).
- 4** Tap [OK].
The new ShortCut is created and the list of ShortCuts is displayed.

To Edit a ShortCut

- 1** Tap the ShortCut you want to edit and tap [Edit].
- 2** Edit [ShortCut Name:] (abbreviation) and [ShortCut Text:] (character string) and tap [OK].

To Delete a ShortCut

- 1** Tap the ShortCut you want to delete and tap [Delete...].
A confirmation dialog box is displayed.
- 2** Tap [Yes].
The selected ShortCut is deleted.

Adjusting the Digitizer

You need to adjust the digitizer when performing a hard reset, when the tapping operation or scrolling does not work properly, or when you cannot adjust the brightness of the backlight or screen contrast.

- 1 Tap ▼ at the top right of the **Preferences** screen, and select [Digitizer].

The **Digitizer calibration** screen is displayed.

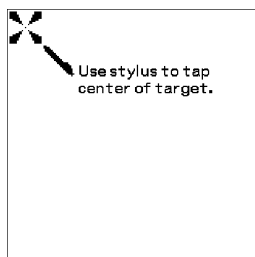

This Digitizer calibration screen is the same as the screen displayed the first time you turned on your CLIÉ handheld. Follow the on-screen instructions to adjust the digitizer.

Tip

Use the stylus perpendicular to the screen to tap targets.

Setting the Network preferences for a wireless LAN (for PEG-UX50 only)

Setting a wireless LAN access point manually

- 1** Tap ▼ at the top right corner of the **Preferences** screen, and select [Network].
- 2** Tap [▼ Service:], and select [Wireless LAN].
- 3** Tap [Details...].
The **Wireless LAN Setup** screen is displayed.
- 4** Tap  (Menu).
The **SSID** menu is displayed.
- 5** Tap [New...] from [SSID].
The **SSID Setup** screen is displayed.
- 6** Enter the SSID into [SSID:].
- 7** Tap [-Not Used-] next to [WEP Key:].
The **WEP Key** screen is displayed.
- 8** Enter WEP Key, and then tap [OK].
The **WEP Key** screen is closed.
- 9** Perform the following procedures if necessary:
 - ① Adhoc mode:**

Your CLIÉ handheld can communicate directly with other wireless LAN compatible devices without using a wireless LAN access point. To use a wireless LAN communication in this mode, tap next to [Adhoc mode:] to change to . Then, tap [▼ 1ch], and select the channel number to use for the wireless LAN communication.

Continued on next page

Setting the Network preferences for a wireless LAN (for PEG-UX50 only)

② Power Save:

The Power Save function is enabled by default. If the communication reception of the wireless LAN is low, cancel the Power Save function, and communicate with the maximum power. In this case, the battery of your CLIÉ handheld is quickly exhausted. Enable Power Save function in normal use. To cancel the Power Save function, tap next to [Power Save:] to change to .

③ IP address:

DHCP (Dynamic Host Configuration Protocol) is enabled by default. When DHCP is cancelled, the **IP Address** screen is displayed and you can manually set up an IP Address, Netmask(Subnet mask), Router(Gateway), Primary DNS, and Secondary DNS. To cancel DHCP, tap next to [IP address:] to change to .

④ Auto Connect:

If this item is enabled, when your CLIÉ handheld is connected to a wireless LAN access point automatically (refer to P.82), this setup is treated as one for selection. Auto Connect is enabled by default. To cancel Auto Connect, tap next to [Auto Connect:] to change to .

10 Tap [OK].

The **SSID Setup** screen is closed, and the **Wireless LAN Setup** screen which added the new SSID setting under [SSID:] is displayed.

11 Tap [OK].

The **Wireless LAN Setup** screen is closed, and the **Preferences** screen is displayed.

.....
Searching and setting a wireless LAN access point manually

- 1** Tap ▼ at the top right corner of the **Preferences** screen, and select [Network].
 - 2** Tap [▼ Service:], and select [Wireless LAN].
 - 3** Tap [Details...].
The **Wireless LAN Setup** screen is displayed.
 - 4** Tap [Scan...].
The **Scan Progress** dialog box is displayed until a wireless LAN access point is found at least. When wireless LAN access point(s) is(are) found, it(they) is(are) displayed on the **Access Points** screen.
- Tip**
- The existing wireless LAN access point may be not detected via Scan operation because of an electric wave condition or timing. Moreover, SSID may be set to be hidden at the wireless LAN access point side. In this case, your CLIÉ handheld also can not detect it.
- 5** Tap one from the found wireless LAN access points, then tap [Select].
The **WEP Key** screen is displayed.
 - 6** Enter the WEP Key and tap [OK].
The **Wireless LAN Setup** screen which added new SSID setting for the selected wireless LAN access point under [SSID:] is displayed.
 - 7** Tap [OK].
The **Wireless LAN Setup** screen is closed, and the **Preferences** screen is displayed.

..... Connecting your CLIÉ handheld to a wireless LAN access point automatically

You can enable the Auto Connect function at the setting of more than one wireless LAN access point. In this case, the most suitable wireless LAN access point is selected.

Tip

To connect your CLIÉ handheld to a wireless LAN access point automatically, enable the Auto Connect function (refer to P.80) by tapping (check box) next to [Auto Connect] at the setting of wireless LAN access point. When the Auto Connect function is enabled for a wireless LAN access point, “*” is indicated at the left side of the SSID of the wireless LAN access point on the **Wireless LAN setup** screen.

- 1** Tap ▼ at the top right corner of the **Preferences** screen, and select [Network].
- 2** Tap [▼ Service:], and select [Wireless LAN].
- 3** Tap [Details...].
The **Wireless LAN Setup** screen is displayed.
- 4** Tap [-Auto Connect-] under [SSID:].
- 5** Tap [OK].
The **Wireless LAN Setup** screen is closed and the **Preferences** screen is displayed.

..... Checking the wireless LAN communication status

Tip

If you need a MAC address, check [MAC Addr:] in the **Link Status** screen by the following method.

- 1 Tap ▼ at the top right corner of the **Preferences** screen, and select [Network].
- 2 Tap [▼ Service:], and select [Wireless LAN].
- 3 Tap [Details...].
The **Wireless LAN Setup** screen is displayed.
- 4 Tap [Status...].
The **Link Status** screen is displayed.
To return to the **Wireless LAN Setup** screen, tap [OK].

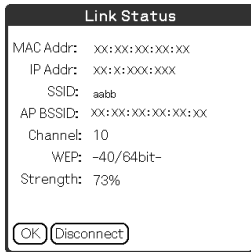

.....
Using the SSID menu

You can create/ edit/ delete/ duplicate a SSID setting on the **Wireless LAN Setup** screen.

- 1** Tap ▼ at the top right corner of the **Preferences** screen, and select [Network].
- 2** Tap [▼ Service:], and select [Wireless LAN].
- 3** Tap [Details...].
The **Wireless LAN Setup** screen is displayed.
- 4** Tap a SSID setting to select under [SSID:], and tap  (Menu).
The **SSID** menu is displayed.

- [New...]** : To create a new SSID setting.
- [Edit...]** : To edit a SSID setting.
- [Delete...]** : To delete a SSID setting.
- [Duplicate...]** : To duplicate a SSID setting.

To return to the **Wireless LAN Setup** screen, tap [OK].

Setting the Network preferences for your provider and dial-up server

Note

For the settings specific to a peripheral device, refer to the manual of that device.

Selecting a service template

You can customize the Service setting to select the service template for your Internet Service Provider or a dial-up server.

- 1 Tap ▼ at the top right of the **Preferences** screen, and select [Network].
The **Preferences** screen for Network is displayed.
- 2 Tap [▼ Service:], and select the service template (**Internet Service Provider name**) you want to use.

Tips

- To add a new service template, select [New] from the **Service** menu.
If the Internet Service Provider name you want to use is not displayed in the list, tap the area showing the service template, or select [New] from the **Service** menu, and enter the new Internet Service Provider name.
You can create multiple service templates for your Internet Service Provider. You should name them so that those service templates are uniquely identified, such as “So-net1” and “So-net2”. This is useful when using your Internet Service Provider by access point. It is also useful when setting the service template.
- If you want to copy an existing service template without changing, select [Duplicate] from the **Service** menu.

Entering a user name

The User Name setting identifies the name you use when you log into your Internet Service Provider (ISP) or dial-up server.

- 1 Tap the User Name field on the **Preferences** screen for Network.
- 2 Enter your user name.

Notes

- Although this field can contain multiple lines of text, only two lines are displayed on-screen at a time.
- Most dial-up servers do not accept spaces in the user name.

Entering a password

The Password setting identifies the password you use to log into your server or ISP. Your entry in this field determines whether your CLIÉ handheld prompts you to enter a password each time you log into your network:

- If you do not enter a password, your CLIÉ handheld displays the word **-Prompt-** in this field and asks you to enter a password during the log-in procedure.
- If you enter a password, your CLIÉ handheld displays the word **-Assigned-** in this field and does not prompt you to enter a password during the log-in procedure.

Note

If you are concerned about security, select the **-Prompt-** and do not enter a password.

- 1** Tap the Password field on the **Preferences** screen for Network.
- 2** Enter the password you use to log into your server.
- 3** Tap [OK].
The **Password** field changes to display the word **-Assigned-**.

Selecting a connection

Use the Connection setting to select the method you want to use to connect to your Internet Service Provider (ISP) or a dial-up server.

- 1** Tap ▼ next to **Connection**, and select [Standard Modem] on the **Preferences** screen for Network.

Setting the telephone information

Define the telephone number you use to connect to your ISP or dial-up server. In addition, you can also define a prefix, disable Call Waiting, and using a calling card.

Note

The calling card option works correctly only for AT&T and Sprint long distance services. If you want to call by MCI, you need to set your telephone information by entering the calling card number in the **Phone #** field and the phone number in the **Use calling card** field.

- 1 Tap the Phone field on the Preferences screen for Network. The **Phone Setup** screen is displayed.
- 2 Enter the phone number for your ISP or dial-up server in the **Phone #** field.
- 3 Define the following settings if necessary:

Dial prefix:

Enter the dial prefix (e.g., “9”) to call an outside line.

① Tap next to [Dial prefix:] to change to .

Enter the dial prefix (e.g., “9,”) in the field next to [Dial prefix:].

Disable call waiting:

When you contract a call-waiting service with your telephone communication company, you have to interrupt the call-waiting function while accessing the Internet. Ask your telephone communication company about the code to interrupt the call-waiting function.

① Tap next to [Disable call waiting:] to change to .

② Enter the code to interrupt the call-waiting function (e.g., “1170,”) in the field next to [Disable call waiting:].

Use calling card:

This option is valid in the USA only.

You can access the Internet using a calling card.

Continued on next page

Setting the Network preferences for your provider and dial-up server

Note

The calling card option works correctly only for AT&T and Sprint long- distance services. If you want to call by MCI, you need to set your telephone information by entering the calling card number in the **Phone #** field and the phone number in the **Use calling card** field.

- ① Tap next to [Use calling card:] to change to .
- ② Enter your calling card number (e.g., “,,,,123456...”) in the field next to [Use calling card:].

Tip

Usually, waiting time is needed before entering a calling card number. When you enter your calling card number, insert at least three commas before your calling card number for rectifying the waiting time (transmission of a calling card number delays for 2 seconds per one comma).

4 Tap [OK].

The **Preferences** screen for Network is displayed.

Adding detailed information to a service template

If you are using one of the predefined service templates, you probably only need to enter your user name and telephone number. If you are creating a new service template, you may need to provide additional information to your ISP or dial-up server. Use the **Details** dialog box to add additional information to a selected service template.

- 1 Tap [▼ Service:] field on the **Preferences** screen for Network, and select the service template (**Internet Service Provider name**) you want to add detailed information.
- 2 Tap [Details...].
The **Details** screen is displayed.
- 3 Tap ▼ next to [Connection type:], and select one of the following connection types.
 - **PPP:**
Point-to-Point Protocol
 - **SLIP:**
Serial Line Internet Protocol
 - **CSLIP:**
Compressed Serial Line Internet Protocol

Tip

If you are not sure, try PPP; if that doesn't work, ask your Internet Service Provider (ISP) or your System Administrator for the correct connection type.

Continued on next page

- 4** Tap ▼ next to [Idle timeout:], and select one of the following options.
 - **1 Minute:**
Waits one minute before dropping the connection when you open another application that does not use the network.
 - **2 Minutes:**
Waits two minutes.
 - **3 Minutes:**
Waits three minutes.
 - **Never:**
Keeps your PPP or SLIP connection open until you turn off your CLIÉ handheld (or until it times out). Note that this option will be more costly than others.

- 5** Tap the Query DNS check box to deselect it.

- 6** Enter the IP address for the Primary and Secondary DNS (Domain Naming System).
Ask your ISP or System Administrator for the correct Primary or Secondary DNS IP numbers.

- 7** If you need to enter your CLIÉ handheld's IP Address, tap the IP Address check box and display a permanent IP address field beneath the check box.
Normally, you do not need to enter this IP address. If you are not sure, select Automatic and go to step 9.

- 8** Enter your CLIÉ handheld's IP Address.

- 9** Tap [OK].

Duplicating/deleting additional service templates

You can create additional service templates from scratch or by duplicating existing templates and editing the information. After you create a new or duplicate template, you can add and edit settings.

Duplicating an existing service template

- 1 Tap [▼ Service:] on the **Preferences** screen for Network, and select the service template you want to duplicate.
- 2 Tap  (Menu).
The menu is displayed.
- 3 Tap [Duplicate] from [Service].
A copy of the service template (**The name of an original service template + Copy**) is added to the drop-down list for the **Service** field.

Deleting a service template

You can delete an existing service template.

- 1 Tap [▼ Service:] on the **Preferences** screen for Network, and select the service template you want to delete.
- 2 Tap  (Menu).
The menus displayed.
- 3 Tap [Delete...] from [Service].
The **Delete Service** dialog box is displayed.
- 4 Tap [OK].
The selected service template is deleted.
To cancel deleting, tap [Cancel].

..... Creating log-in scripts

A log-in script is a series of commands that automates logging in to a network server, such as your corporate network or your Internet Service Provider (ISP). You can also use non-ASCII characters or literal characters for Log-in Scripts.

► For details, refer to “Non-ASCII Characters for Log-in Scripts” on page 94.

- 1** Tap ▼ at the top right of the **Preferences** screen, and select [Network].
- 2** Tap [▼ Service:] on the **Preferences** screen for Network, and select the predefined service template you want to create log-in scripts.
- 3** Tap [Details...].
The **Details** screen is displayed.
- 4** Tap [Script...].
The **Log in Script** screen is displayed.
- 5** Tap ▼ next to [End], and select one of the following commands.
If the command requires additional information, a field is displayed to the right of it for you to enter the information.

Continued on next page
.....

Setting the Network preferences for your provider and dial-up server

Wait For	Makes your CLIÉ handheld wait for specific characters from the TCP/IP server before executing the next command.
Wait For Prompt	Detects a challenge-response prompt coming from the server and displays the dynamically generated challenge value. Then enter the challenge value into your token card, which in turn generates a response value for you to enter on your CLIÉ handheld. This command takes two arguments, separated by a vertical bar () on the input line.
Send	Transmits specific characters to the TCP/IP server to which you are connecting.
Send CR	Transmits a carriage return or LF character to the TCP/IP server to which you are connecting.
Send User ID	Transmits the User ID information entered in the User ID field of the Preferences screen for Network.
Send Password	Transmits the password entered in the Password field of the Preferences screen for Network. If you did not enter a password, this command prompts you to enter one. The Password command is usually followed by a Send CR command.
Delay	Makes your CLIÉ handheld wait a specific number of seconds before executing the next command in the log-in script.
Get IP	Reads an IP address and uses it as the IP address for your CLIÉ handheld. This command is used with SLIP connections.
Prompt	Opens a dialog box and prompts you to enter text (for example, a password or a security code).
End	Identifies the last line in the log-in script.

6 Repeat step 4 until the log-in script is complete.

7 Tap [OK].
The **Details** screen is displayed.

8 Tap [OK].
The **Preferences** screen for Network is displayed.

Continued on next page

Non-ASCII Characters for Log-in Scripts

The following information enables you to create custom log-in scripts that require non-ASCII characters. It is provided for advanced users who understand the use and requirements of such characters in a custom log-in script.

Use of ^char

You may use the caret (^) to transmit ASCII command characters. If you send ^char, and the ASCII value of character is between @ and _, then the character is automatically translated to a single-byte value between 0 and 31.

For example, ^M is converted to a carriage return.

If character is a value between A and Z, then the character sequence is translated to a single-byte value between 1 and 26. If character is any other value, then the character sequence is not subject to any special processing. For example, the string “Joe^M” transmits Joe, followed by a carriage return.

Carriage return and line feed

You may include carriage return and line feed commands as part of the log-in script, when they are entered in the following format.

- <cr> : Sends or receives a carriage return
- <lf> : Sends or receives a line feed

For example, the string “wait for Joe<cr><lf>” waits to receive Joe followed by a carriage return and line feed from the remote computer, before executing the next command in the script.

Literal characters

The backslash (\) character defines that the next character is transmitted as a literal character, and is not subject to any special processing ordinarily associated with that character.

Examples:

- \^ : Includes a caret as part of the string
- \< : Includes a < as part of the string
- \\ : Includes a backslash as part of the string

Using the Network preferences menus

This section describes the menu commands specific to network preferences. For the menu commands that are common for the CLIÉ handheld applications, refer to “Common menu items” on page 38.

Service menus

New	Creates a new service template.
Delete...	Deletes the current service template.
Duplicate	Duplicates the current service template.

Option menus

View Log	Displays the Network Log screen that lists the history of your Internet connection. Tap [Done] to close the Network Log screen.
-----------------	--

Assigning applications to application buttons

You can assign your favorite applications to the application buttons on the front panel of your CLIÉ handheld.

For example, you can assign the Date Book button to start **Calculator**.

- ▶ For details, refer to “CLIÉ™ handheld components” in the “Read This First (Operating Instructions)”.

- 1 Tap ▼ at the top right of the **Preferences** screen, and select [Buttons].

The **Preferences** screen for Buttons is displayed.

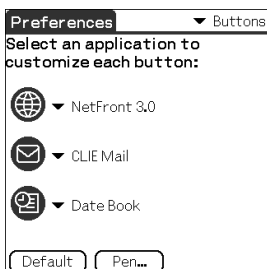

The screen may vary depending on your model.

- 2 Tap ▼ next to the icon, and select the application you want to assign.

The application button is changed.

To start the default applications

If you assign another application to a button, you can still start the default application from the CLIE 3D Launcher.

To reset to default settings

Tap [Default] in step 2.

All application buttons are reset to their factory settings.

Customizing the full-screen pen stroke activities

You can customize the assignment of the full-screen pen stroke.

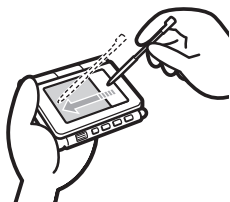

Drag the stylus to the other end of the screen from the Silk Screen area.

The full-screen pen stroke will perform the function you assigned to it.

Tip

Pressing the Ctrl and R key on the hardware keyboard at the same time also displays the function assigned to full-screen pen stroke.

- 1 Tap ▼ at the top right of the **Preferences** screen, and select [Buttons].
- 2 Tap [Pen...].
The **Pen** screen is displayed.
- 3 Tap [▼ Graffiti2 Help], and select the settings for the full-screen pen stroke.

Backlight	Turns on the backlight of your CLIÉ handheld without using the POWER button.
Brightness	Opens the Adjust Brightness screen.
Keyboard	Opens the on-screen keyboard for entering text.
Graffiti2 Help	Opens a series of screens that show the complete Graffiti character set.
Turn Off & Lock	Turns off and locks your CLIÉ handheld. To turn on your CLIÉ handheld when it is locked, you must enter a password. ➔ For details, refer to “Protecting your data with a password” (page 173).
Beam Data	Beams the current record to another Palm OS PDA.

- 4 Tap [OK].

Setting the automatic power-off time

Your CLIÉ handheld has an automatic power-off feature that turns off after a period of inactivity to conserve your CLIÉ handheld battery.

You can adjust the time setting for the automatic power-off feature.

By default, your CLIÉ handheld will turn off after two minutes of inactivity and will remain on when connected to the charger cradle.

- 1** Tap ▼ at the top right of the **Preferences** screen, and select [General].
The **Preferences** screen for General is displayed.
- 2** Tap ▼ next to [Auto-off After:], and select the desired time.
You can select 30 seconds, 1 minute, 2 minutes, or 3 minutes.
- 3** If you want to leave your CLIÉ handheld turned on while it is connected to the charger cradle, tap (check box) next to [Stay on in Cradle:].

Tips

- [Auto-off After:] is selected [2 minutes] by the default.
- [Stay on in Cradle:] is by the default.

Note

If you tap [Auto Lock Handheld] to lock in the **Security** screen (page 176), the **Stay on in Cradle** function is cancelled, and the data protection takes priority.

Setting sounds

You can adjust the volume level of the system sounds, alarm sounds, and game sounds, or turn the sound off completely.

- 1** Tap ▼ at the top right of the **Preferences** screen, and select [General].

The **Preferences** screen for General is displayed.

- 2** Tap ▼ next to [System Sound:], and select the desired volume level or [Off].

When [System Sound:] is turned off, the chime tones associated with the HotSync® operation are also turned off.

- 3** Tap ▼ next to [Alarm Sound:], and select the desired volume level or [Off].

- 4** Tap ▼ next to [Game Sound:], and select the desired volume level or [Off].

[Game Sound:] setting is only applied to the games programmed to respond to this setting.

Turning the Alarm LED on or off

You can set your CLIÉ handheld to flash its LED at a set time. If you turn the Alarm Sound off and turn the Alarm LED on, you can use the alarm feature without disturbing people around you.

- 1** Tap ▼ at the top right of the **Preferences** screen, and select [General].

The **Preferences** screen for General is displayed.

- 2** Tap ▼ next to [Alarm LED:], and select [On] or [Off].

Turning the Beam Receive feature on or off

You can turn on or off the Beam Receive feature.

When you turn off the Beam Receive feature, you cannot receive data via beaming. By default, the Beam Receive feature is set to On to conserve your CLIÉ handheld battery.

- 1** Tap ▼ at the top right of the **Preferences** screen, and select [General].
- 2** Tap ▼ next to [Beam Receive:], and select [On] or [Off].
 - **On:** Enables the Beam Receive feature.
 - **Off:** Disables the Beam Receive feature.

Selecting the screen color theme

You can select the screen color theme.

For example, to select the screen color theme, Indigo:

- 1** Tap ▼ at the top right of the **Preferences** screen, and select [General].
- 2** Tap ▼ next to [colors:], and tap [Indigo] from the list box.
The screen color theme is changed to Indigo.

Tips

The screen color theme is set to [Original] by default.

Note

This function is not applicable to all applications.

Setting the display format for time, date, and numbers

Selecting a regional default

When you select the region where you use your CLIÉ handheld, the display format of the time, date, week start day, and numbers are adjusted to the regional default. For example, in the United Kingdom, time is expressed using a 24-hour clock; in the United States, time is expressed using a 12-hour clock with an AM or PM suffix.

The regional default setting is applied to the display formats of all your CLIÉ handheld applications. However, you can customize your own settings for each unit, such as time or date.

- 1 Tap ▼ at the top right of the **Preferences** screen, and select [Formats].
- 2 Tap ▼ next to [Preset to:], and select a region name.

Customizing your own settings

You can customize your own settings for the display formats of the time, date, week start day, and numbers. The settings are applied to the display formats of all your CLIÉ handheld applications.

- 1 Tap ▼ at the top right of the **Preferences** screen, and select [Formats].
- 2 Tap ▼ next to [Time:], and select the desired format.
- 3 Tap ▼ next to [Date:], and select the desired format.
- 4 Tap ▼ next to [Week starts:], and select [Sunday] or [Monday].
This setting is applied to the Day, Week, Month, and Agenda views in **Date Book** and all other applications displaying calendars.
- 5 Tap ▼ next to [Numbers:], and select the desired format.

Changing the position of the Silk Screen area

You can change the position of the Silk Screen area to the right side or left side of the screen.

For example, to change the position of the Silk Screen area from the right to the left side:

- 1** Tap ▼ at the top right of the **Preferences** screen, and select [Extension].
- 2** Tap ▼ at the [Silk Position:], and tap [Left] from the list box. The position of the Silk Screen area is changed to the left side.

Tip

You can change the position of the Silk Screen area to right side by tapping [Right] in step 2.

Switching the keyboard-illumination

You can turn the keyboard-illumination on or off.

For example, to turn it off:

- 1** Tap ▼ at the top right of the **Preferences** screen, and tap [Extension] from the list box.
- 2** Tap ▼ at [Keyboard LED:], and tap [Off] from the list box.

Tip

You can switch the keyboard-illumination on by tapping [On] in step 2.

Starting applications by pressing the Ctrl key and a numeric key

If you assigned the Shortcut key-combination to start an application, you can start the application by pressing the Ctrl key and a numeric key.

- 1 Tap ▼ at the top right of the **Preferences** screen, and select [Extension] from the list box.
- 2 Tap [Setting] at [Hotkey Setting:].
The **Hotkey Setting** screen is displayed.

For example, to start **Calc** by pressing the Ctrl key and the number 1:

- 3 Tap ▼ next to [Ctrl+1=], and select [Calc].
- 4 Tap [Done].
The **Preferences** screen is displayed.

Tips

- If you want to cancel a shortcut key-combination, select [-NotAssigned-] in step 3.
- You can set other combinations in the same way.
- If you want to cancel shortcut key-combination, tap [All Clear] at the bottom center of the **Hotkey Setting** screen in step 3.

Adding/Changing communication device preferences

You can customize the preference for a communication device to be connected to your CLIÉ handheld. The applications using the communication device will comply with this preference.

- 1** Tap ▼ at the top right of the **Preferences** screen, and select [Connection].
- 2** Tap [New...].
- 3** Enter the connection name in [Name:] field.
Enter a suitable name.
- 4** Tap ▼ next to [Connect to:], and select how you connect your CLIÉ handheld to your computer.
- 5** Tap ▼ next to [Via:], and select what you use to connect your CLIÉ handheld to your computer.

If you select a modem for [Connect to:]

- ① Tap ▼ next to [Dialing:], and select the type of line you want to use.
The recommended setting is [TouchTone™].
Do not select [Rotary] unless you are sure that the telephone service being used is not [TouchTone™].
 - ② Tap ▼ next to [Volume:], and select the volume of the modem speaker at the time of connection.
 - ③ Tap [Details...].
 - ④ Tap ▼ next to [Speed:], and select the maximum speed for the transmission between the modem and CLIÉ handheld.
 - ⑤ Tap ▼ next to [Flow Ctl:], and select the flow control of the modem connection.
The recommended setting is [Automatic].
 - ⑥ Enter the modem initialization command in [Init String:].
By default, it is set to either **AT&FX4** or **ATZ**. If the modem initialization command is not specified on the modem, changes are not required.
 - ⑦ Tap [OK].
- 6** Tap [OK].
The configuration for the communication device is changed and the **Preferences** screen is displayed.

Setting up the Date & Time preferences

You can set the date, time, time zone, and daylight savings on/off for your CLIÉ handheld. After you set the local date and time of your home base, you can change the displayed time (for example, during business trips) simply by switching the time zones.

Setting the date

- 1 Tap ▼ at the top right of the **Preferences** screen, and select [Date & Time].
The **Preferences** screen for Date & Time is displayed.
- 2 Tap next to [Set Date:].
The **Set Date** screen is displayed.
- 3 Tap ◀ or ▶ beside the year at the top of the screen to set the year.
- 4 Tap the current month.
- 5 Tap the current date.

Setting the time

- 1 Tap ▼ at the top right of the **Preferences** screen, and select [Date & Time].
The **Preferences** screen for Date & Time is displayed.
- 2 Tap next to [Set Time:].
The **Set Time** screen is displayed.
- 3 Tap ▼ or ▲ to set the hour.
- 4 Tap the minute box and tap ▼ or ▲ to set the minute.
- 5 Tap [AM] or [PM].
- 6 Tap [OK].

..... Setting the time zone and daylight saving time

Setting the time zone

- 1** Tap ▼ at the top right of the **Preferences** screen, and select [Date & Time].
The **Preferences** screen for Date & Time is displayed.
- 2** Tap next to [Set Time Zone field:].
The **Set Time Zone** screen is displayed.
- 3** Select the time zone of your region.
- 4** Tap [OK].

Setting the daylight saving time

- 1** Tap ▼ at the top right of the **Preferences** screen, and select [Date & Time].
The **Preferences** screen for Date & Time is displayed.
- 2** Tap ▼ next to [Daylight Saving:].
- 3** Tap [On] or [Off].

Setting the Phone function

You need to configure the Phone Preferences before using SMS.

- 1 Tap ▼ at the top right of the **Preferences** screen, and select [Phone].

The **Preferences** screen for Phone is displayed.

- 2 Tap ▼ under [Connection:], and select [Sony BT to GSM] or [Edit Connections...].

Sony BT to GSM: You can connect to your GSM phone via BT.

Edit Connections: You can select any other available connections.

Tip

The default setting is [Sony BT to GSM].

- 3 Tap [Details].

The **Phone Driver Details** screen is displayed.

- 4 Tap ▼ next to [Phone:].

If you chose the default connection configuration [Sony BT to GSM], you can select the appropriate GSM phone model from the list.

- 5 Tap [OK].

Note

When you tap [Test], your CLIÉ™ handheld begin to search devices connectable by the Bluetooth function, according to the contents set up.

Exchanging and updating files/data using the HotSync[®] operation (Other HotSync[®] operations)

This chapter explains how to select the HotSync[®] operating options and how to perform the HotSync[®] operation with a USB cable, infrared communications port, or network. Other advanced HotSync[®] operations include how to use file link functions and how to import data from Windows applications.

Customizing HotSync[®] application settings (Conduit)	112
Synchronizing with external data (File Link) ..	114
Customizing HotSync[®] Manager startup and HotSync[®] setup options	115
Performing the HotSync[®] operation via a wireless LAN (for PEG-UX50 only)	116
Performing the HotSync[®] operation using the Bluetooth[®] function	119
Performing the IR HotSync[®] operation	123
Performing the HotSync[®] operation via LAN (LANSync)	126

Customizing HotSync® application settings (Conduit)

A program handling the data of an application during the HotSync® operation is called a “conduit”.

For each application, you can define a set of options that determine how data is handled during synchronization. By default, the HotSync® operation synchronizes all files/data between your CLIÉ handheld and **Palm™ Desktop for CLIÉ**.

In addition to the conduits for **Date Book, Address Book, To Do List**, and **Memo Pad, Palm™ Desktop for CLIÉ** offers System and Install conduits. The System conduit backs up the system information stored on your CLIÉ handheld. The Install conduit installs add-on applications to your CLIÉ handheld. You can select them as needed.

- 1 Click  (HotSync) in the Windows task tray (Notification area) at the bottom right of the computer window, and select [Custom] from the HotSync® Manager menu.

You can also select [Custom] from the **HotSync** menu of **Palm™ Desktop for CLIÉ**.

The **Custom** window is displayed.

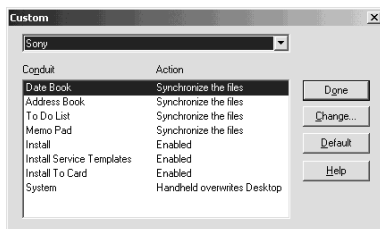

- 2 Select the user name you are using on your CLIÉ handheld from the list at the top.
- 3 Select an application in the Conduit list.

Continued on next page

- 4 Click [Change].
The **Change HotSync Action** window is displayed.

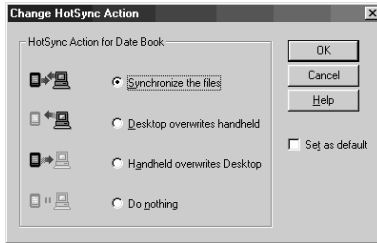

- 5 Click to select one of the following:
 - **Synchronize the files**
 - **Desktop overwrites handheld**
 - **Handheld overwrites Desktop**
 - **Do nothing**
- 6 Click [OK].
- 7 Repeat steps 2 to 6 to customize conduit settings for other applications (or other users).
- 8 Click [Done].
The conduit setting is changed.

Notes

- The conduit setting is applied only to the next HotSync® operation. Thereafter, the HotSync Actions revert to their default settings. To set a new setting as the default, in step 5, select the **Set as default** check box.
- To restore the default settings, click [Default] in the **Custom** dialog box.

Synchronizing with external data (File Link)

You can synchronize **Address Book** or **Memo Pad** data in your CLIÉ handheld with external files such as **Address Book** data in your computer (File Link).

HotSync® Manager stores the files in your computer in a separate category on your **Palm™ Desktop for CLIÉ** and your CLIÉ handheld. You can set the File Link feature to start synchronization only when the external file has been updated.

Compatible file formats that you can import with File Link:

- Comma delimited (*.csv)
- Memo Pad archive of **Palm™ Desktop for CLIÉ** (*.mpa)
- Address Book archive of **Palm™ Desktop for CLIÉ** (*.aba)
- Text file (*.txt)

* The words in parentheses are file extensions. Archive is a unit that gathers associated files.

- ➔ For details on how to set up File Link, refer to the online help of **Palm™ Desktop for CLIÉ**.

Customizing HotSync[®] Manager startup and HotSync[®] setup options



- 1 Click  (HotSync) in the Windows task tray (Notification area) at the bottom right of the computer window, and select [Setup] from the shortcut menu.
The **Setup** dialog box is displayed.
 - 2 Click [General] tab, and select the setting as needed.
If you are not sure which option to use, select [Always available].
 - **Always available:** Starts the HotSync[®] Manager when Windows starts. This allows you to perform a HotSync[®] operation even when **Palm[™] Desktop for CLIE** is not running.
 - **Available only when the Palm Desktop is running:** Starts the HotSync[®] Manager when you start **Palm[™] Desktop for CLIE**.
 - **Manual:** Starts the **HotSync[®] Manager** only when you select [HotSync[®] Manager] from [start] in Windows.
 - 3 Click [Local] tab and adjust the setting for the connection between the computer and your CLIE handheld as needed.
 - **Serial port:** Specifies the computer port that is used for the HotSync[®] operation. Make sure that the serial port for the HotSync[®] operation is not shared with the port for modem.
 - **Speed:** Determines the speed at which files/data are transferred. Try the **As Fast As Possible** rate first, and adjust downward if you have any problems.
- Note**
- You can not perform the HotSync operation via a serial port between your CLIE handheld and a computer.
- 4 Click [Modem] tab, and select the setting for the modem as needed.
 - 5 Click [Network] tab, and select the setting for the network as needed.
 - 6 Click [OK] to finish.

Performing the HotSync® operation via a wireless LAN (for PEG-UX50 only)

To operate the HotSync® operations via a network, you must have network administrator skills.

You can perform the HotSync® operation via a network between your CLIÉ handheld and the computer on the LAN of your office, depending on the network environment of your office. For details, contact the System Administrator of the LAN.

Preparing your computer

- 1 Click  (HotSync) in the Windows task tray (Notification area) at the bottom right of the computer window, and select [Network] from the shortcut menu.
- 2 Click  (HotSync) in the Windows task tray (Notification area) at the bottom right of the computer window once again, and select [Setup] from the shortcut menu.
The **Setup** dialog box is displayed.
- 3 Click [Network] tab.
- 4 Click the check box next to the user name for HotSync.
- 5 Click [OK].
- 6 Connect your CLIÉ handheld to the computer by a USB cable, and perform the Hotsync operation by tapping  (HotSync).

The computer information (Primary PC name and Primary PC address (IP address)) is transferred to your CLIÉ handheld.

When you perform the HotSync® operation via a network, your CLIÉ handheld identifies the computer based on the information transferred.

Continued on next page

Preparing your CLIÉ handheld

Follow the steps below to set up your CLIÉ handheld for the HotSync® operation via a network.

- 1 Rotate the Jog Dial™ navigator to select  (HotSync) on the CLIE 3D Launcher and press the Jog Dial™ navigator. The **HotSync** screen is displayed.

Tip

You can also tap  (HotSync) to display the **HotSync** screen.

- 2 Tap [Modem].
- 3 Tap  (Menu).
The menu is displayed.
- 4 Tap [Modem Sync Prefs] from [Options].
The **Modem Sync Preferences** screen is displayed.

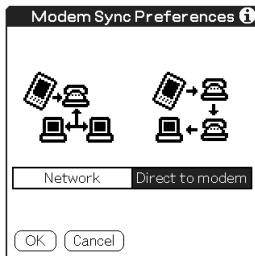

- 5 Tap [Network].
- 6 Tap [OK].
The **HotSync** screen is displayed.
- 7 Tap [Select Service] beneath the icon.
The **Network Preferences** screen is displayed.

Continued on next page

Performing the HotSync® operation via a wireless LAN (for PEG-UX50 only)

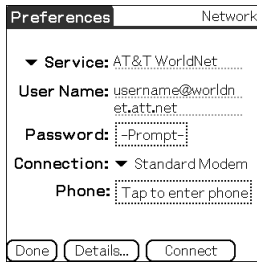

8 Tap [▼ Service:], and select [Wireless LAN] from the drop-down list.

9 Tap [Done].

Tip

You do not have to enter a Telephone No. into [#####].

Performing the HotSync® operation via a network

You can perform the HotSync® operation via a network when you have prepared your computer settings, CLIÉ handheld settings, and Conduit Setup.

1 Rotate the Jog Dial™ navigator to select  (HotSync) on the CLIÉ 3D Launcher and press the Jog Dial™ navigator. The **HotSync** screen is displayed.

Tip

You can also tap the HotSync icon to display the **HotSync** screen.

2 Tap  (HotSync).
The HotSync® operation starts.
A message will be displayed when the HotSync® operation is complete.

Performing the HotSync[®] operation using the Bluetooth[®] function

If you are using a Bluetooth[®] compatible computer, you can perform the wireless HotSync[®] operation between your CLIÉ handheld and computer.

Prior to performing the HotSync[®] operation using the Bluetooth[®] function

To perform the HotSync[®] operation between your CLIÉ handheld and computer using the Bluetooth[®] function, you need to configure a new connection setting for Bluetooth[®] to register your computer as a target device.

Preparing your CLIÉ handheld

Note

Prior to performing the following procedure, enable the Bluetooth[®] function of your computer. For details, refer to the manual of your computer.

- 1 Tap ▼ at the top right of the **Preferences** screen, and select [Connection].
- 2 Tap [New...].
- 3 Enter the connection name in the **name** field.
Enter a unique name for each computer.
Custom is displayed by default.
- 4 Tap ▼ next to [Connect to], and select [PC].
- 5 Tap ▼ next to [Via], and select [Bluetooth].
- 6 Tap [Tap to Find] next to [Device].
Your CLIÉ handheld starts to detect Bluetooth[®] compatible devices located within a range of the communication area.
When detection is complete, Bluetooth[®] compatible devices around your CLIÉ handheld are listed.

Continued on next page

Performing the HotSync® operation using the Bluetooth® function

Tip

If you have renamed a target Bluetooth® compatible device registered on your CLIE handheld, the device may be listed in the previous name when you detect target Bluetooth® compatible devices.

In this case, follow the procedure below.

- ① Tap  (Menu) on the **Preferences** screen for Bluetooth.
- ② Tap [Disable device name cache] from [Options].
- ③ Detect target Bluetooth® compatible devices.

7 Select a computer you want to register and tap [OK].
The **Add Trusted Device** dialog box is displayed.

8 Tap [Yes].
The **Bluetooth Security** dialog box is displayed on your CLIE handheld.

9 Enter a passkey and tap [OK] on your CLIE handheld.
The **Passkey Input** dialog box is displayed on the screen of the selected computer.

Tip

What is a passkey?

A Passkey is a secret code entered by the user to enable two Bluetooth® compatible devices to communicate. When the same alphanumeric string is entered at both devices, communication becomes possible. The Passkey may be changed for every communication session as long as the same one is used for both devices. Once a valid link has been established, communication is possible without further Passkey input for a preset period of time.

10 Enter the same passkey you entered in step 9, on your computer.

If the name you entered in step 3 is added to the **Available Connections:** list, the preparation is complete.

Continued on next page

Performing the HotSync® operation using the Bluetooth® function

Tips

- The step in which the **Passkey Input** screen is displayed varies depending on the mobile phone, and for some devices, the **Passkey input** screen is not displayed. In any case, follow the instructions shown on the screen and enter a Passkey when required.
- Depending on the radio wave conditions, it may take time to complete a Bluetooth® compatible device discovery or establish communication.
- If it takes too long to perform a device discovery, tap [Cancel] on the discovery screen, and conduct a discovery again.
- If the device discovery failed in detecting a device, conduct a discovery again.

Performing the HotSync® operation using the Bluetooth® function

- 1 Enable the Bluetooth® function on your computer.
- 2 Check that  (HotSync) is displayed in the Windows task tray (Notification area) at the bottom right of the window on your computer.

Tip

If  (HotSync) is not displayed in the Windows task tray (Notification area), click [Start], select [Programs] (for Windows XP, select [All Programs]), [Sony Handheld], and click [HotSync Manager] to start the HotSync manager.

- 3 Rotate the Jog Dial™ navigator to select  (HotSync) on the CLIE 3D Launcher and press the Jog Dial™ navigator. The **HotSync** screen is displayed.

Tip

You can also tap the HotSync icon to display the **HotSync** screen.

- 4 Check that [Local] is selected.

Continued on next page

Performing the HotSync® operation using the Bluetooth® function

- 5** Tap ▼ beneath the icon, and select the connection you want to use.
Select the connection name you created in step 3 in “Preparing your CLIÉ handheld” on page 119.

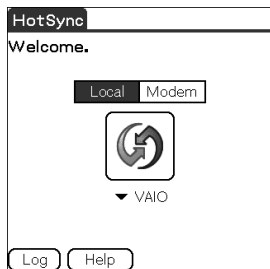

- 6** Tap  (HotSync).
The HotSync® operation starts.
A message will be displayed when the HotSync® operation is complete.

Tip

The Bluetooth® communication between your CLIÉ handheld and computer will be disconnected automatically when the HotSync® operation is complete.

Performing the IR HotSync® operation

You can use the IR (infrared) port of your CLIÉ handheld to perform the IR HotSync® operation with a computer equipped with an IrDA (Infrared Data Association) IR port.

Prior to performing the IR HotSync® operation

Check the following items:

- Your computer is equipped with an infrared port supporting the IrDA standard.
- The infrared port of your computer is enabled for use with your Windows operating system.
- Check the port number allocated to the infrared port.
- The infrared port number is available in the **Infrared Monitor** in the **Control Panel**.

For details on the Infrared Monitor, refer to the manual of your computer or the Windows online help.

Preparing your computer

To perform the IR HotSync® operation, you need to allocate a virtual port to the IR HotSync® operation.

For Windows 2000 Professional/Windows XP

- 1 Click  (HotSync) in the Windows task tray (Notification area) at the bottom right of the computer window, and select [IR] from the shortcut menu.
IR HotSync® operation is enabled.

For Windows 98 Second Edition/Me

- 1 Click  (HotSync) in the Windows task tray (Notification area) at the bottom right of the computer window and check [Local Serial] from the shortcut menu.

Continued on next page

Performing the IR HotSync® operation

- Click  (HotSync) in the Windows task tray (Notification area) at the bottom right of the computer window once again, and select [Setup] from the shortcut menu. The **Setup** window is displayed.

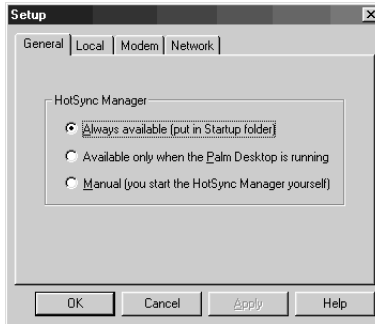

- Click [Local] tab.
- Adjust the following settings as needed.
 - **Serial port:** Specifies a virtual port for an infrared port. If you are not sure of the connection port, refer to the **Infrared Monitor** in the **Control Panel**.
 - **Speed:** Determines the speed at which files/data are transferred. Try the **As Fast As Possible** rate first, and adjust downward if you have any problems.
- Tap [OK].
The IR HotSync® operation is enabled.

Note

When performing a local HotSync® operation with a USB cable, you need to restore the local HotSync settings.

► For details, refer to “To restore the local HotSync settings” on page 125.

Continued on next page

Performing the IR HotSync® operation

You can perform the IR HotSync® operation when you have prepared your computer settings, CLIÉ handheld settings, and Conduit Setup.

- 1 Rotate the Jog Dial™ navigator to select the  (HotSync) on the CLIÉ 3D Launcher and press the Jog Dial™ navigator.
The **HotSync** screen is displayed.

Tip

You can also tap the HotSync icon to display the **HotSync** screen.

- 2 Tap [Local].
- 3 Tap ▼, and select [IR to a PC/Handheld].
- 4 Point the IR port of your CLIÉ handheld directly to the IR port of the computer.
For best results, your computer and your CLIÉ handheld should be 4 to 8 inches (approximately 10 to 20 centimeters) apart, and the path between your CLIÉ handheld and the computer must be clear of obstacles.
- 5 Tap  (HotSync).
The HotSync® operation starts.
A message will be displayed when the HotSync® operation is complete.

To restore the local HotSync settings

When performing the local HotSync® operation, restore the local HotSync settings with a USB cable.

- 1 Connect your CLIÉ handheld to your computer with a USB cable.
- 2 Click  (HotSync) in the Windows task tray (Notification area) at the bottom right of the computer window, and select [Local USB] from the shortcut menu.

Performing the HotSync® operation via LAN (LANSync)

To operate LANSync, you must have network manager skills. Consult a network manager prior to setting LANSync.

You can perform the HotSync® operation via LAN between your computer and another computer connected to your CLIÉ handheld.

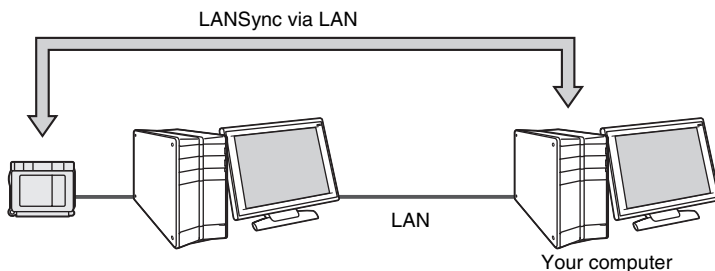



Prior to performing a LANSync operation

Check the following items:



- **Palm™ Desktop for CLIÉ** is installed in both computers connected by the LAN.
- Your CLIÉ handheld is placed in the charger cradle connected to the HotSync cable correctly and the charger cradle is connected to the computer properly.

Preparing your computer

- 1 Click the  (HotSync) in the Windows task tray (Notification area) at the bottom right of the computer window, and select [Network] from the shortcut menu.
- 2 Click  (HotSync) in the Windows task tray (Notification area) at the bottom right of the computer window once again, and select [Setup] from the shortcut menu.
The **Setup** dialog box is displayed.
- 3 Click [Network] tab.
- 4 Click the check box next to the user name for HotSync.
- 5 Click [OK].

Continued on next page

Performing the HotSync® operation via LAN (LANSync)

- 6 Connect your CLIÉ handheld to your computer with a USB cable.
- 7 Rotate the Jog Dial™ navigator to select the  (HotSync) on the CLIÉ 3D Launcher and press the Jog Dial™ navigator.
- 8 Tap  (HotSync).
The computer information (Primary PC name and Primary PC address (IP address)) is transferred to your CLIÉ handheld.
When you perform the HotSync® operation via LAN, your CLIÉ handheld identifies the computer based on the information transferred.

Preparing your CLIÉ handheld

Follow the steps below to set up your CLIÉ handheld for the HotSync® operation via the LAN.

- 1 Rotate the Jog Dial™ navigator to select the  (HotSync) on the CLIÉ 3D Launcher and press the Jog Dial™ navigator.
The **HotSync** screen is displayed.

Tip

You can also tap the HotSync icon to display the **HotSync** screen.

- 2 Tap [Local].
- 3 Tap  (Menu).
The menu is displayed.
- 4 Tap [LANSync Prefs] in [Options].
The **LANSync Preferences** screen is displayed.

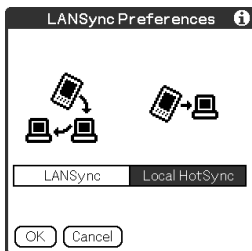

Continued on next page

Performing the HotSync® operation via LAN (LANSync)

5 Tap [LANSync].

6 Tap [OK].

The **HotSync** screen is displayed again.

Performing a LANSync operation

You can perform a LANSync operation when you have prepared your computer settings, CLIE handheld settings, and Conduit Setup. Turn on the computers and start the HotSync® Manager.

Note

To perform a LANSync operation, both the computer connected to your CLIE handheld and the computer performing the HotSync® operation should be set for LANSync. Also, click  (HotSync) to display the shortcut menu in the Windows task tray (Notification area) at the bottom right of the computer window on each computer and make sure that [Network] in the shortcut menu is selected (If not, click [Network] to select it).

1 Rotate the Jog Dial™ navigator to select the  (HotSync) on the CLIE 3D Launcher, and press the Jog Dial™ navigator.

The **HotSync** screen is displayed.

Tip

You can also tap the HotSync icon to display the **HotSync** screen.

2 Tap  (HotSync).

The HotSync® operation starts.

A message will be displayed when the HotSync® operation is complete.



Using storage media such as “Memory Stick™” media

This chapter explains how to communicate with another Palm OS® PDA device via storage media such as “Memory Stick” media, how to handle “Memory Stick” media, and how to use **CLIE Files** for managing the files/data on storage media.

Using storage media such as “Memory Stick™” media	130
Exchanging data via storage media	138

Using storage media such as “Memory Stick™” media

The type of storage media you can use with your CLIE handheld

You can use your CLIE handheld with storage media, such as “Memory Stick” media. “Memory Stick” media is specially designed for exchanging and sharing files/data among “Memory Stick” media compatible products. Because it is removable, storage media can also be used for external files/data storage. Furthermore, your CLIE handheld has an Internal Media to store files and data. Storage media enables you to exchange files/data between your CLIE handheld and a computer. To exchange files/data via storage media, your CLIE handheld uses the supplied **CLIE Files**.

Using “Memory Stick” media

There are two types of “Memory Stick” media:

- “MagicGate Memory Stick” media, which is equipped with “MagicGate*” copyright protection technology.
- “Memory Stick” media, which is not equipped with “MagicGate” copyright protection technology.

You can use both types of “Memory Stick” media with your CLIE handheld. However, to play music files of ATRAC3 format, make sure that you use “MagicGate Memory Stick” media.

*What is MagicGate?

MagicGate is the copyright protection technology that is used for “MagicGate Memory Stick” media or MagicGate compatible devices, such as a CLIE handheld. MagicGate certifies the compatible device and “MagicGate Memory Stick” media as copyright protection-compatible devices and encodes files/data to be played back on devices. Copyrighted files/data cannot be played back on a device not certificated.

“Memory Stick Duo”, “MagicGate Memory Stick Duo”, and “Memory Stick PRO”** can be used with your CLIE handheld.

** You can use the “Memory Stick PRO” MSX-1G, MSX-512, and MSX-256 with your CLIE handheld.

However, you cannot record or play back files/data that have been copyright protected with the MagicGate function.

➡ For the latest information, refer to the URL shown on the last page of this manual.

Continued on next page

Note on using “MagicGate Memory Stick” media

Do not handle copyright-protected files/data or directories stored on “MagicGate Memory Stick” media with **CLIE Files** or Windows® Explorer, otherwise the files/data may be disabled. To handle copyright-protected files/data, use a “MagicGate” compliant application, such as the SonicStage software.

Notes

If you use a “Memory Stick Duo” with your CLIE handheld

- Make sure you use a “Memory Stick Duo” adapter.
- Make sure you insert a “Memory Stick Duo” into the “Memory Stick Duo” adapter in the right direction.
- Make sure you insert a “Memory Stick Duo” into the adapter before you insert the adapter into the “Memory Stick” slot of your CLIE handheld.
- Make sure you insert a “Memory Stick Duo” adapter into the “Memory Stick” slot of your CLIE handheld in the right direction.

Notes on using “Memory Stick” media

When you use “Memory Stick” media, follow the precautions below.

- Avoid touching the terminals of “Memory Stick” media with your fingers or a metal object.
- Do not drop, bend, or expose “Memory Stick” media to external shock.
- Do not disassemble or modify “Memory Stick” media.
- Avoid getting liquid on “Memory Stick” media.
- Avoid using or storing “Memory Stick” media in a location subject to:
 - extremely high temperature such as inside a hot car, outdoors in direct sunlight, or near a heater
 - direct sunlight
 - high humidity
 - corrosive substances
 - excessive dust
 - magnetic fields
- When storing and carrying “Memory Stick” media, keep it in its original case to ensure protection of important files/data.
- Make a backup of important files/data.
- Avoid removing “Memory Stick” media from the insertion slot while files/data is being written or read.
- To avoid damaging or erasing files/data, do not
 - pull out “Memory Stick” media or unplug the AC power adapter while formatting, or reading or writing files/data.
 - use “Memory Stick” media in a location subject to static electricity or electrical interference.

Continued on next page

Using storage media such as “Memory Stick™” media

- If the battery power of your CLIÉ handheld is running low, an error message is displayed and you cannot exchange files/data with “Memory Stick” media. If this occurs, connect your CLIÉ handheld to the charger cradle or fully charge your CLIÉ handheld.
- Use **CLIE Files** to format the “Memory Stick” media you use in your CLIÉ handheld. If you format it using another application, further operation with your CLIÉ handheld is not guaranteed.
- If you insert “Memory Stick” media that has been formatted by another application, a message prompting you to reformat it is displayed. To use “Memory Stick” media in your CLIÉ handheld, follow the instructions to format it. Note, however, that all stored files/data will be erased.
- Make sure you stick a suitable label on the “Memory Stick” media.

Protecting the files/data on “Memory Stick” media

To prevent accidental erasure of important files/data, you can use the write protect tab on the “Memory Stick” media.

Write enable position

Slide the tab to the left to select the write enable position. You can read and write files/data on the “Memory Stick” media.

Write protect position (LOCK)

Slide the tab to the right to select the write protect position. You can only read the files/data on the “Memory Stick” media. Select the write protect position when you insert “Memory Stick” media containing any important files/data that you do not want to accidentally delete or overwrite.

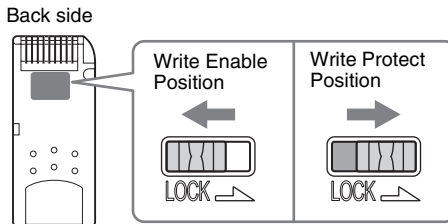

Tip

Shape or exact location of the tab may differ from the illustration.

Starting an application on storage media

You can start applications on storage media in the same way as applications on your CLIÉ handheld. While the power of your CLIÉ handheld is on, the applications in the storage media will be displayed on the CLIE 3D Launcher automatically when you insert the storage media into the slot. (The feature does not work when certain applications are running).





To switch from the CLIE 3D Launcher to the screen where the applications in storage media are displayed, perform the following steps.

Note

Do not start applications supplied with your CLIÉ handheld from Internal Media or “Memory Stick” media.

Tip

You can only start the applications stored in the **/Palm/Launcher** directory by the following operation.

- 1 Tap  (Home).
The CLIE 3D Launcher is displayed.
- 2 Tap the group menu, and then tap  (Card) or  (Int.Media).
The applications stored in the **Palm/Launcher** folder on storage media are displayed.
You can start an application in the same way that you start an application of your CLIÉ handheld.
If you have assigned a name to the storage media, then the  (####) is displayed in that name.

Note



Depending on the application, some of the features may not work if you start the application on storage media. In this case, use **CLIE Files** to copy the files/data in your CLIÉ handheld and use the copied files/data.

Viewing information of storage media (Card Info)

You can view information (e.g., remaining memory space) of storage media with **Card Info**.

Tip

If you use “Memory Stick” media, insert the “Memory Stick” media into your CLIE handheld before this operation.

- 1 Tap  (Home).
The CLIE 3D Launcher is displayed.
- 2 Rotate the Jog Dial™ navigator to select  (Card Info) on the CLIE 3D Launcher and press the Jog Dial™ navigator.
The **Card Info** screen is displayed.

Tip

You can also tap  (Card Info) to display the **Card Info** screen.

- 3 Tap ▼ next to [Card:] to select storage media.
The information screen of the storage media is displayed.



Card Info
Card: ▼  Card
Type: Memory Stick
Size: 17.2 MB Free of 61.8 MB
44.5 MB Used
17.2 MB Free of 61.8 MB
MEMORYSTICK (64M)
SONY
Memory Stick
Device Id:

.....
Assigning a name to “Memory Stick” media

You can assign a name to “Memory Stick” media with **Card Info**.

Note

You can not rename the Internal Media.

- 1** Insert the “Memory Stick” media into your CLIE handheld.
- 2** Rotate the Jog Dial™ navigator to select  (Card Info) on the CLIE 3D Launcher and press the Jog Dial™ navigator. The **Card Info** screen is displayed.
- 3** Tap ▼ next to [Card:], and select  (Card).
- 4** Tap  (Menu). The menu is displayed.
- 5** Tap [Rename Card] from [Card]. The **Rename Card** dialog box is displayed.



- 6** Enter a new name for the inserted “Memory Stick” media and tap [Rename].

Formatting “Memory Stick” media

If you format your “Memory Stick” media, use always **CLIE Files** or **Card Info**. The following explains how to format “Memory Stick” media with **CLIE Files**. (Purchased “Memory Stick” media is already formatted for use.)

Note

You can not format the Internal Media.

- 1 Insert the “Memory Stick” media into your CLIE handheld.
- 2 Rotate the Jog Dial™ navigator to select  (CLIE Files) on the CLIE 3D Launcher and press the Jog Dial™ navigator. **CLIE Files** starts.



Tip

You can also tap  (CLIE Files) to start the application.

- 3 Tap  at the top right of the **CLIE Files** screen to select [MS].

Tip

You can also tap  (MS) to select.

- 4 Tap  (Menu).
The menu is displayed.
- 5 Tap [Format] from [Tool].
The **Format** screen is displayed.
- 6 Tap  next to [Select the card], and select [MS].
- 7 Tap [OK].
- 8 Enter a new name for the “Memory Stick” media and tap [OK].
A confirmation message is displayed.
- 9 Tap [OK].

To cancel formatting

Tap [Cancel] in step 7, 8, and 9.

Continued on next page

What is formatting?

Formatting defines the recording format for your “Memory Stick” media so that you can access files/data with your CLIÉ handheld.

Notes

- If storage media is reformatted, all the files/data stored on the “Memory Stick” media will be erased. Make sure you check the files/data prior to formatting so that you do not delete important files/data.
- When formatting “Memory Stick” media for use with your CLIÉ handheld, be sure to format it on your CLIÉ handheld. A storage media formatted by any other device may not be read or written properly on your CLIÉ handheld.
- If you remove the “Memory Stick” media during formatting, the “Memory Stick” media will not be usable. In this case, insert the storage media again and restart formatting.

Exchanging data via storage media

Starting CLIE Files

You can copy, move, or delete files/data between storage media and your CLIE handheld with **CLIE Files**.

➤ For details on **CLIE Files**, refer to “CLIE Files” in the “CLIE Application Manual” installed on your computer.

- 1 Rotate the Jog Dial™ navigator to select  (CLIE Files) on the CLIE 3D Launcher and press the Jog Dial™ navigator. **CLIE Files** starts.

Tip

You can also tap  (CLIE Files) to start the application.

- 2 Tap  at the top right of the **CLIE Files** screen to select [Handheld] or storage media.

Tip

You can also tap , , or  (MS) to select.

When displaying the files/data on storage media

Tap here to sort in ascending or descending order

Tap here to switch the view
Handheld: CLIE handheld
Int.Media: Internal Media
MS: “Memory Stick” media

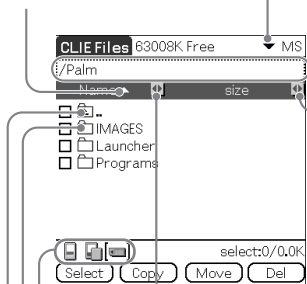

Tap here to switch to the Directory list screen

Tap here to switch the view of the following:

- size: File size
- date: Updated date
- time: Updated time
- creator: Creator ID of the file
- type: File type
- version: Version of the file
- none: no items displayed

Tap here to switch the view between your CLIE handheld, Internal Media and “Memory Stick” media



Tap here to switch the view of the following:

- Name: name displayed on the computer
- DBname: name assigned on your CLIE handheld

: Tap to display the contents of the zip files*

: Tap to display the contents of the directory*

: Tap to display the upper directory*

* , , and  are specific to the screen when displaying the data on storage media. Except for these icons, all icons in the screen are common to the one when displaying the files/data on your CLIE handheld. You can also rotate the Jog Dial™ navigator to select a directory.

Continued on next page

Tip

You can select a directory in the **Directory list** screen and tap [OK] to display the contents of the directory. Additionally, you can tap [New] to create a new directory or tap [Rename] to change the name of existing directory.

Notes

- You can display up to nine levels of the directory tree.
- The latest change date of the database may not be displayed correctly, depending on how the application was installed.
- When the battery power of your CLIÉ handheld is insufficient, files/data on storage media will not be displayed. In this case, you need to charge your CLIÉ handheld or connect the AC power adapter to your CLIÉ handheld.

When displaying the data on your CLIÉ handheld

Tap here to switch the database display by group

- All databases
- Creator group
- Application

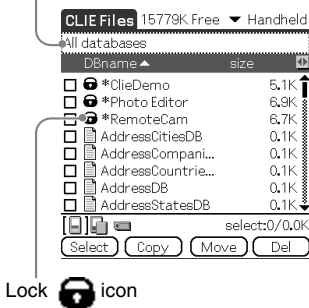

Notes on moving or deleting files/data using CLIÉ Files

In some cases when you move or delete specific files/data using **CLIÉ Files**, some CLIÉ handheld applications may not operate properly or some files/data may be formatted. Sony is not liable for any problems with applications or files/data, that arise from your moving or deleting a file/data.

Do not move or delete the following files:

- **Saved Preferences:** The final operation status or settings for various applications.
- **Unsaved Preferences:** The settings for various applications or user information of your CLIÉ handheld. If this file is deleted, you may not be able to synchronize the correct information.

Continued on next page

Exchanging data via storage media

- **CLIELauncher XXX**: The database for CLIE 3D Launcher. If this file is deleted, you may not be able to operate CLIE 3D Launcher.
- **NetworkDB**: Network settings. If this file is deleted, network connection is disabled.
- **AddressDB**: The database for **Address Book***.
- **DatebookDB**: The database for **Date Book***.
- **MemoDB**: The database for **Memo Pad***.
- **ToDoDB**: The database for **To Do List***.

* These database files can be copied to storage media as a backup file. If you copy them back to your CLIÉ handheld, the identical files in your CLIÉ handheld will be overwritten with the information at the time of the backup. Note that any added or edited information in your CLIÉ handheld after the backup will not be restored.

Note

When the battery power of your CLIÉ handheld is insufficient, data on “Memory Stick” media will not be displayed. In this case, you need to charge your CLIÉ handheld or connect the AC power adapter to your CLIÉ handheld.

Copying your CLIÉ handheld data to storage media

You can save your CLIÉ handheld data to storage media with **CLIE Files**.

Notes

- Since copying data consumes a lot of power, you cannot use “Memory Stick” media when your CLIÉ handheld battery power is low. In this case, connect your CLIÉ handheld to the charger cradle.
- If your CLIÉ handheld receives IR communication while copying data, the copying will be interrupted. Do not allow your CLIÉ handheld to receive IR communication while copying data.
- Insert “Memory Stick” media into your CLIÉ handheld before copying or moving data. Never remove “Memory Stick” media while you are copying or moving data between your CLIÉ handheld and “Memory Stick” media.
- Incomplete copying or moving may leave an invalid file on your CLIÉ handheld or the storage media. In this case, retry copying or moving, and if the confirm overwrite message is displayed, tap [Yes] or [Yes to all].

Tip

When you use “Memory Stick” media, before the following, insert “Memory Stick” media into your CLIÉ handheld.

Continued on next page

- 1 Rotate the Jog Dial™ navigator to select  (CLIE Files) on the CLIE 3D Launcher and press the Jog Dial™ navigator. **CLIE Files** starts.

Tip

You can also tap  (CLIE Files) to start the application.

- 2 Tap  at the top right of the **CLIE Files** screen to select **Handheld**.

All the **Handheld** data are displayed.

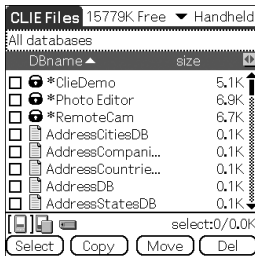

- 3 Tap the data you want to copy to change to . You can select multiple items by selecting the check boxes.

Note

Data marked with  cannot be copied.

- 4 Tap [Copy].
The **Directory list** screen is displayed.
- 5 Tap the storage media directory.
When you want to create a new directory on storage media, tap [New] and enter the directory name. Tap the directory created.
When you want to rename an existing directory, tap [Rename] and enter the new name.
- 6 Tap [OK].
The data are copied to the directory selected in step 5.

Continued on next page

To copy all the data at once

Tap [Select] in step 3 and select [Select All].

To cancel the selection

- **To cancel all the selections:** tap [Select] and select [Clear All].
- **To clear only specific items:** tap the selected item once again.

When you want to select data other than the one specified

After following step 3, tap [Select] and select [Invert]. The selections of and are reversed.

Moving your CLIÉ handheld data to storage media

When the available memory in your CLIÉ handheld is insufficient, you can move the data from your CLIÉ handheld to storage media.

- 1** In step 4 above, tap [Move].

The selected data on your CLIÉ handheld are transferred to the storage media and saved.

Copying data on storage media to your CLIE handheld

You can copy the data saved on storage media to your CLIE handheld. Prior to copying data, make sure that the memory space of your CLIE handheld is sufficient.

Tips

- You can also copy data to another directory on the storage media.
- When you use “Memory Stick” media, before the following, insert “Memory Stick” media into your CLIE handheld.

- 1 Rotate the Jog Dial™ navigator to select  (CLIE Files) on the CLIE 3D Launcher and press the Jog Dial™ navigator. **CLIE Files** starts.

Tip

You can also tap  (CLIE Files) to start the application.

- 2 Tap  at the top right of the **CLIE Files** screen to select storage media.
All the files/directory on the selected storage media are displayed.

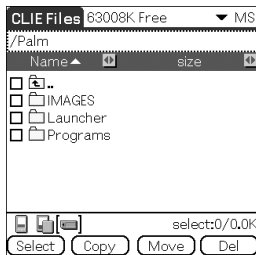

- 3 Tap the data you want to copy to change to .
You can select multiple items by selecting the check boxes.
- 4 Tap [Copy].
The **Directory list** screen is displayed.

Continued on next page

5 Select [Handheld].

6 Tap [OK].

The data selected in step 3 are copied to Handheld.



To copy all the data at once

Tap [Select] in step 3 and select [Select All].

To cancel the selection

- **To cancel all the selections:** tap [Select] and select [Clear All].
- **To clear only specific items:** tap the selected item once again.

To change the directory to be copied

Tap  or  to select the directory you want to copy. The displays of the directory are changed. You can specify a directory to be copied.

Moving data on storage media to your CLIÉ handheld

You can move the data from storage media to your CLIÉ handheld.

1 In step 4 above, tap [Move].

The selected data on the storage media are transferred to your CLIÉ handheld and saved.

Note

Some data copied from storage media to your CLIÉ handheld may not be synchronized during the HotSync[®] operation.

Deleting files/directory on storage media

You can delete the files/directory from storage media with **CLIE Files**.

Tip

When you use “Memory Stick” media, before the following, insert “Memory Stick” media into your CLIE handheld.

- 1 Rotate the Jog Dial™ navigator to select  (CLIE Files) on the CLIE 3D Launcher and press the Jog Dial™ navigator. **CLIE Files** starts.

Tip

You can also tap  (CLIE Files) to start the application.

- 2 Tap ▼ at the top right of the **CLIE Files** screen to select storage media.
All the files/directory on the selected storage media are displayed.

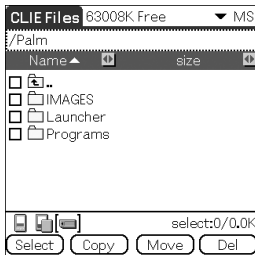

- 3 Tap the file/directory you want to delete to change to .
- 4 Tap [Del].
The **Delete File** dialog box is displayed.
- 5 Tap [OK].
The files/directory selected in step 3 are deleted from storage media.

To delete all the data at once



Tap [Select] in step 3 and select [Select All].

Continued on next page

To cancel the selection

- **To cancel all the selections:** tap [Select] and select [Clear All].
- **To clear only specific items:** tap the selected item once again.

To change the directory to be deleted

Tap  or  to select the directory you want to delete. The displays of the directory are changed. You can specify a directory to be deleted.

Extracting a Zip file

You can extract Zip files without using a computer, either downloaded from a website using **NetFront v3.0 for CLIE**, or received as attachment files with an e-mail on **CLIE Mail**.

Tip

When you use “Memory Stick” media, before the following, insert “Memory Stick” media into your CLIE handheld.

- 1** Rotate the Jog Dial™ navigator to select  (CLIE Files) on the CLIE 3D Launcher and press the Jog Dial™ navigator. **CLIE Files** starts.

Tip

You can also tap  (CLIE Files) to start the application.

- 2** Tap  at the top right of the **CLIE Files** screen to select storage media.

All the files/directory on the selected storage media are displayed.

 is Zip files.



Continued on next page

Tips

- A Zip file downloaded using **NetFront v3.0 for CLIE** will be stored in the / **Palm/Programs/Archive** directory of the storage media.
- An attached file received by **CLIE Mail** will be stored in the /**Palm/Programs/MSFILES** directory of the storage media.

3 Tap the Zip file you want to extract.

The contents of the Zip file are displayed on the screen.

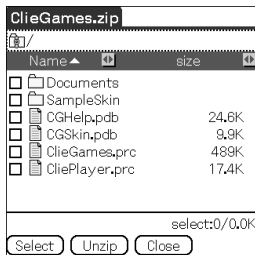

4 Tap the file you want to extract to change to .

You can select multiple files by selecting the check boxes.

5 Tap [Unzip].

The **Directory list** screen is displayed.

6 Tap a directory in which to save the extracted data.

You can also save the data on your CLIE handheld.

Note

Some data cannot be saved on your CLIE handheld. In these cases, an error message is displayed.

7 Tap [OK].

The data is extracted to the directory selected in step 6.

: Files that were extracted normally.

: Files that could not be extracted.

: Files that were skipped during extraction.

8 Tap [Close].



To extract all the data at once

Tap [Select] in step 4 and select [Select All].

To cancel the selection

- To cancel all the selections: tap [Select] and select [Clear All].
- To clear only specific items: tap the selected item once again.

To change the directory to be deleted

Tap  or  to select the directory you want to delete. The displays of the directory are changed. You can specify a directory to be deleted.

CLIE Files menu items

The following describes the menu items that are specific to **CLIE Files**.

For the menu items common to CLIE handheld applications, refer to “Common menu items” on page 38.

Tool menu

Format	Formats (initializes) “Memory Stick” media inserted into your CLIE handheld. Note that all data stored on “Memory Stick” media will be erased when formatting the “Memory Stick” media.
Media Info	Displays information, such as the amount of memory or volume label, of your CLIE handheld or storage media.
New Dir	Creates a directory within the current directory on the storage media. (Only when storage media is selected).
Rename	Changes the name of current directory or file. (Only when “Memory Stick” media is selected).
About CLIE Files	Displays the version information of CLIE Files .

Exchanging files/data without using CLIE Files





You can exchange the data between storage media and your CLIÉ handheld or between “Memory Stick” media and Internal Media from the menu of the CLIE 3D Launcher.

However, problems may occur depending on the application. Note the following.

- You can copy only applications to storage media. Related data cannot be copied.
- Data stored on the storage media (e.g., image files) cannot be displayed.
- Do not start applications supplied with your CLIÉ handheld from Internal Media or “Memory Stick” media.
- Data marked with  cannot be copied.

Tip

When you use “Memory Stick” media, before the following, insert “Memory Stick” media into your CLIÉ handheld.

- 1** Tap  (Menu) on the CLIE 3D Launcher.
The menu is displayed.
- 2** Tap [Copy] from [CLIE 3D Launcher].
The **Copy** dialog box is displayed.
- 3** Tap ▼ next to **Copy To**, and select [Handheld], [ Int.Media] or [ Card].
- 4** Tap ▼ next to **From** to select [ Card], [ Int.Media] or [Handheld].
- 5** Tap the application you want to copy.
- 6** Tap [Copy].
The selected application is copied to [Handheld] or storage media.

Notes on starting applications from storage media

When an application is installed on storage media by HotSync, be careful of the followings.

- Do not start applications supplied with your CLIÉ handheld from Internal Media or “Memory Stick” media.
- Related files/data such as image files or movie files may not be opened (played back).
- When the files/data that cannot be opened in the application are saved on the storage media, move the files/data to your CLIÉ handheld, or delete them by using **CLIE Files**.

Tip

When PRC format (.prc) or PDB format (.pdb) files are installed on storage media with the HotSync® operation, the files are stored in the **/Palm/Launcher** directory.



Beaming

This chapter explains how to communicate with another Palm OS[®] PDA device via the infrared communications port.

Beaming between your CLIÉ handheld and another Palm OS[®] PDA 153

Beaming between your CLIÉ handheld and another Palm OS[®] PDA

What you can do with beaming

Your CLIÉ handheld is equipped with an IR (infrared) port that enables you to exchange data or applications with another Palm OS[®] PDA device that has an IR port. The IR port is located at the left side of your CLIÉ handheld, behind the small dark shield.

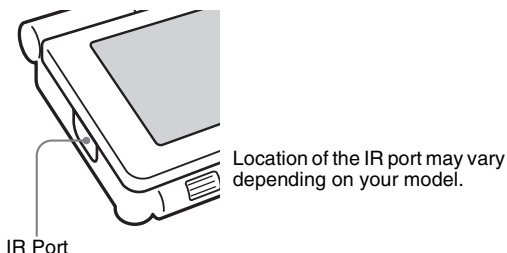

You can beam the following information between your CLIÉ handheld and another Palm OS[®] PDA device that has an IR port:

- The data of **Address Book**, **Date Book**, **To Do List**, or **Memo Pad**.
- All data in the category currently displayed in **Address Book**, **To Do List**, or **Memo Pad**.
- **Address Book** data that you designate as your business card.
- Add-on applications installed in the memory.

Note

Some applications are protected from copying and cannot be beamed. Applications marked with  cannot be copied.

Beaming information

You can beam the data on your CLIÉ handheld to another Palm OS PDA device that has an IR port.

- 1** Select the data, category, or business card you want to beam.
- 2** Tap  (Menu).
The menu is displayed.
- 3** Tap one of the following:
 - The Beam command for an individual record
 - In Address only: Beam Business Card
 - Beam Category
- 4** When the **Beam** dialog box is displayed, point the IR port of your CLIÉ handheld directly to the IR port of another Palm OS PDA device.
The **Beam** dialog box shows that the transfer is complete.







Location of the IR port may vary depending on your model.

Tip

For best performance of the data exchange, keep 4 to 8 inches (approximately 10 to 20 centimeters) between your CLIÉ handheld and the other Palm OS PDA device. Do not place any obstacle between the devices. The optimum distance for beaming may vary depending on devices.

Continued on next page

Sending applications via beaming

- 1** Tap  (Menu) on the CLIE 3D Launcher.
The menu is displayed.
- 2** Tap [Beam...] from [CLIE 3D Launcher].
The **Beam** screen is displayed.
- 3** Tap ▼ next to [Beam Form:] and select [Handheld].
Select [Handheld] when the application you want to send is saved on your CLIÉ handheld or  (card) or  (Int. Media) when it is saved on the / **Palm/Launcher** directory on the storage media.
- 4** Tap an application you want to send, on the **Beam** screen.
Some applications are protected from copying and cannot be beamed.
Applications marked with  cannot be copied.
- 5** Tap [Beam].
A message will be displayed when the beaming is complete.

Continued on next page

Receiving beamed information

- 1** Turn on your CLIÉ handheld and point the IR port of your CLIÉ handheld directly to the IR port of another Palm OS PDA device.

The **Beam** dialog box is displayed and beaming of data or applications starts.

- 2** Select the category where you want to save the received data or applications.

Data or applications received by beaming are saved in the **Unfiled** category.

You can also create a new category to save the data or applications to, or save it in the **Unfiled** category.

- 3** Tap [Yes].

The data or applications are saved.

Note

When [Beam Receive:] in the **Preferences** screen for General is set to [Off], you cannot receive data or applications using the beaming feature. Prior to beaming data or applications, set [Beam Receive:] to [On].

Using the Bluetooth[®] function

This chapter explains how to exchange information, such as applications or data, with another Bluetooth[®] compatible device using the Bluetooth[®] function.

Exchanging files/data using the Bluetooth[®] function	158
What you can do with the Bluetooth [®] function	158
Sending files/data, such as image files or Date Book data, to another CLIE handheld with the built-in Bluetooth [®] function or Bluetooth [®] Module (optional)	158
Performing the wireless HotSync [®] operation with a computer	159
Connecting to the Internet by communicating with a Bluetooth[®] compatible mobile phone . .	160

Exchanging files/data using the Bluetooth® function

What you can do with the Bluetooth® function

The Bluetooth® function enables wireless communication within a range of 33 feet (approximately 10 meters). You can use the function to exchange files/data between your CLIE handheld and other Bluetooth® compliant devices.

Sending files/data, such as image files or Date Book data, to another CLIE handheld with the built-in Bluetooth® function or Bluetooth® Module (optional)



1 Select a file/data.

① Sending an image file, movie file, voice memo, or handwritten memo

Start **CLIE Viewer**, tap  (Menu) to display the menu, select [Send...] from [Data], and tap a file/data you want to send.

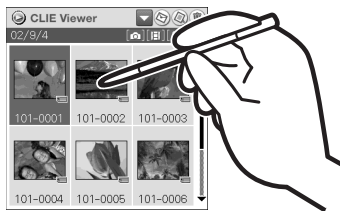

Tip

Sending image files

You can select a method of sending files/data in the **Send With** dialog box. (The dialog box below may not be displayed depending on your operating environment).

Continued on next page

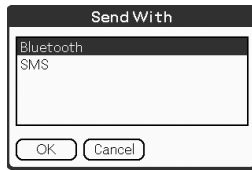

② Sending Date Book data or Address Book data

Tap the schedule data or address data you want to send, tap  (Menu) to display the menu, and then select [Send Event] (for **Date Book**) or [Send Address] (for **Address Book**) from the menu.

2 Send a file/data.

After the **Bluetooth Discovery** dialog box is displayed, the list of Bluetooth® compatible CLIÉ handhelds within range of the communication area is displayed on the **Discovery Results** dialog box. Tap to select a CLIÉ handheld to which you want to send data. The **Bluetooth Progress** dialog box will be displayed on both CLIÉ handhelds. Follow the on-screen instructions.

Tip

If you have renamed a target Bluetooth® compatible device registered on your CLIÉ handheld, the device may be listed in the previous name when you detect target Bluetooth® compatible devices.

In this case, follow the procedure below.

- ① Tap  (Menu) on the **Preferences** screen for Bluetooth.
- ② Tap [Disable device name cache] from [Options].
- ③ Detect target Bluetooth® compatible devices.

Note

To view or edit received files/data, applications supporting each file/data must be installed on your CLIÉ handheld.

Performing the wireless HotSync® operation with a computer

If you are using a Bluetooth® compatible computer, you can perform the wireless HotSync® operation between your CLIÉ handheld and your computer.

- For details, refer to “Performing the HotSync® operation using the Bluetooth® function” on page 119.

Connecting to the Internet by communicating with a Bluetooth® compatible mobile phone

You can enjoy browsing various websites or send/receive e-mails using your CLIE handheld, via a Bluetooth® compatible mobile phone.

Connecting

When you access the Internet via a Bluetooth® compatible mobile phone, you need to follow this procedure to pair the device with your CLIE handheld.

1 Setting the connection method/Performing pairing

2 Setting up the network connection

Tip

What is pairing?

To enable Bluetooth® communication between this Bluetooth® Module and another Bluetooth® compatible device, the device must be identified. This process is referred to as pairing which is necessary to prevent access from unauthorized Bluetooth® compatible devices. A common Passkey is used to pair the device with this Bluetooth® Module.

1 Setting the connection method/Performing pairing

You need to set the communication method and perform pairing for Bluetooth® communications.

- 1 Rotate the Jog Dial™ navigator to select  (Prefs) on the CLIE 3D Launcher and press the Jog Dial™ navigator. The **Preferences** screen is displayed.

Tip

You can also tap  (Prefs) to display the **Preferences** screen.

- 2 Tap ▼ at the top right of the screen, and select [Connection]. The list of **Available Connections** is displayed.

Continued on next page

Connecting to the Internet by communicating with a Bluetooth® compatible mobile phone

3 Tap [New...].

The **Edit Connection** screen is displayed.

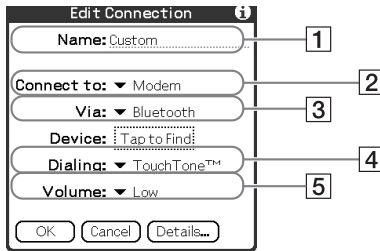

1 Name: Enter any connection name you like.
Custom is displayed by default.

2 Connect to: Tap ▼ and select [Modem].

3 Via: Tap ▼ and select [Bluetooth].

4 Dialing: Tap ▼ and select the type of telephone circuit you use. The most common selection is [TouchTone™].

5 Volume: Tap ▼ and select the speaker volume to browse the Internet.

4 Tap [Tap to Find] next to [Device:].

Bluetooth® compatible device discovery begins in the vicinity of your CLIÉ handheld.

When the discovery is complete, Bluetooth® compatible devices found around your CLIÉ handheld are displayed.

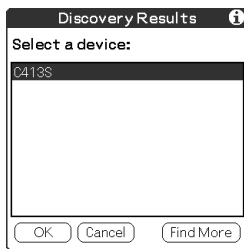

Continued on next page

- 5** Select the mobile phone you want to pair with your CLIÉ handheld, and tap [OK].

The **Add Trusted Device** dialog box is displayed.



- 6** Tap [Yes].

The **Passkey Input** screen is displayed on the display of the mobile phone.

Tip

What is a Passkey?

A Passkey is a secret code entered by the user to enable two Bluetooth® compatible devices to communicate. When the same alphanumeric string is entered at both devices, communication becomes possible. The Passkey may be changed for every communication session as long as the same one is used for both devices. Once a valid link has been established, communication is possible without further Passkey input for a preset period of time.

- 7** Enter a Passkey on the mobile phone, and click [OK].

The **Authentication** screen appears on your CLIÉ handheld.

- 8** Enter the same Passkey you entered in step 7 and tap [OK] on your CLIÉ handheld.

Pairing is completed on your CLIÉ handheld and the mobile phone. The communication method you have set is added to the list of **Available Connections** by the name you entered in [Name:] in step 3.

Continued on next page

Tips

- The step in which the **Passkey Input** screen is displayed varies depending on the mobile phone, and for some devices, the **Passkey input** screen is not displayed. In any case, follow the instructions shown on the screen and enter a Passkey when required.
- Depending on the radio wave conditions, it may take time to complete a Bluetooth® compatible device discovery or establish communication.
- If it takes too long to perform a device discovery, tap [Cancel] on the **discovery** screen, and conduct a discovery again.
- If the device discovery failed in detecting a device, conduct a discovery again.

Note

Enter a Passkey to activate security. If the security is off and you access the Internet from your CLIE handheld through a Bluetooth® compatible mobile phone, you may be charged the telephone line rental fee that someone else should be paying for.

2 Setting up the network connection

You need to set up the network connection in the **Preferences** screen.

- 1 Tap ▼ at the top right of the **Preferences** screen, to select [Network].
- 2 Enter the information about your Internet Service Provider (ISP).

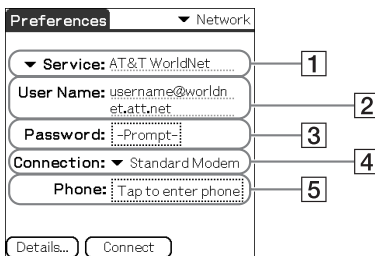

1 Service

Select the service (ISP name) to be used.

If a service you want to use is not listed, select [New] from the menu and add the service name to the list.

2 User Name

Enter the user name specified by ISP.

3 Password

Enter the password specified by your ISP.

Continued on next page

Connecting to the Internet by communicating with a Bluetooth® compatible mobile phone

4] Connection

Select the connection that is compliant with your network card.

5] Phone

Enter the phone number of the access point specified by your ISP.

Tip

For details, contact your ISP or telephone carrier.

Connecting to the Internet

- 1 Turn on the power of the mobile phone and activate Bluetooth® communications.
For detailed operations, refer to the manual of the mobile phone.
- 2 Start the appropriate application on the CLIE 3D Launcher of your CLIE handheld.
- 3 Start browsing websites, sending or receiving e-mail.
A dial-up connection is executed.

If you cannot connect to the Internet

Tap ▼ at the top right of the **Preferences** screen, and select [Network].

Tap [Connect] at the bottom of the screen.

If you still cannot connect to the Internet, perform pairing again for the Bluetooth® compatible device (mobile phone), following the instructions in “Connecting” on page 160.

After using the Internet

- 1 Stop the dial-up connection on your CLIE handheld.
► For detailed operations, refer to the “CLIE Application Manual” on your computer.
- 2 Terminate Bluetooth® communications on the mobile phone.

Tip

Bluetooth® communication between your CLIE handheld and the mobile phone is automatically cut off when the dial-up connection is disconnected.



Using the Calculator and finding records

This chapter explains how to use the calculator and how to efficiently search for records.

Using the Calculator (Calc)	166
Finding records	169

Using the Calculator (Calc)

Making Calculations

You can perform basic calculations with **Calculator**. Moreover, you can save values in the calculator memory and recall them from the memory.

- 1 Rotate the Jog Dial™ navigator to select  (Calc) on the CLIE 3D Launcher, and press the Jog Dial™ navigator. **Calculator** starts.

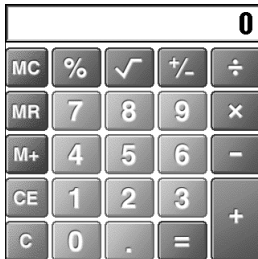

Tip

You can also tap  (Calc) to start the application.

- 2 Perform calculations.

To use **Calculator**, tap the numbers or symbols on the screen with the stylus.

The functions of the Calculator buttons

The calculator has several buttons to help you perform calculations.

CE	Clears the last number you entered. Use this button if you make a mistake while entering numbers. This button enables you to re-enter the number without starting the calculation again.
C	Clears the entire calculation and enables you to start a new calculation.
+/-	Toggles the current number between positive and negative. If you want to enter a negative number, enter the number and then tap this button.
M+	Adds the current number to the total value in the memory. Each number you enter with this button is added to the total value stored in the Calculator memory. The number to be added can be either a calculated value or the number you entered by pressing the number buttons. Pressing this button has no effect on the current calculation (or series of calculations); it merely adds the value to the memory.
MR	Recalls the total value stored in the Calculator memory and inserts it in the current calculation.
MC	Clears any value that is stored in the Calculator memory.
$\sqrt{\quad}$	Calculates the square root of the entered number. Tap the button after entering the number.

.....

Using the Calculator menus

Edit menus

Copy, Paste

Copies values from **Calculator** and pastes them into another application. You can also paste numeric values you copied from another application, such as **Memo Pad**, into **Calculator**.

Options menus

Recent Calculations

You can review the last series of calculations. (If you quit the application, the contents of the calculation is cleared.)

About Calculator

Shows the version information for **Calculator**.

Finding records

Using the Find option

You can find records, such as Date Book, Address Book, To Do List, or Memo Pad data on your CLIÉ handheld, by entering the whole word or the first few letters. The search results are displayed by application. This feature helps if you do not remember which application you used to create the record you are searching for.

Note

The Find option is not compatible with some application data.

- 1 Tap  (Find).
The **Find** dialog box is displayed.



- 2 Enter the text you want to find.
You can enter letters, symbols, or numbers.

- 3 Tap [OK].
The **Find** option starts to search and displays the list of search results. Comments attached to data can also be searched for.

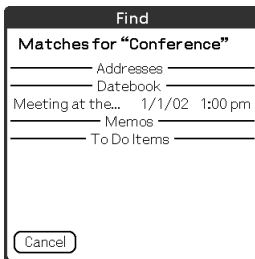

Continued on next page

- 4 Tap the data you want to view in the list of search results. The application associated with the data automatically starts and opens the data.

To stop searching

Tap [Stop] and [Exit].

To resume the search, tap [Find More].

Note

The **Find** option is not case sensitive; searching for “sony” also finds “Sony”.

Tip

If you select text in an application prior to tapping  (Find), the text is automatically placed in the **Find** dialog box.



Backing up your CLIÉ™ handheld data and applications

This chapter explains how to make a backup of your CLIÉ handheld data.

Backing up your CLIÉ™ handheld data and applications	172
Backing up data and applications to your computer with the HotSync® operation.	172

Backing up your CLIÉ™ handheld data and applications

You can create a backup of your CLIÉ handheld data by storing data to your computer through the HotSync® operation.

Backing up data and applications to your computer with the HotSync® operation

By the default settings, you can back up the following data to your computer through the HotSync® operation:

- Memo Pad files/data
- Address Book files/data
- To Do List files/data
- Date Book files/data
- Preferences files/data
- Application files/data that have been installed using the HotSync® operation
- User information files to perform the HotSync® operation

When the HotSync® operation is performed, the backup data is compared with the data in your computer, and the newer data becomes effective. If you perform a hard reset, all data stored in your CLIÉ handheld is erased and the initial status will be restored. If this happens, you can restore the backup data from your computer that was created through the previous HotSync® operation.

Note also that, if you stored data and applications in the Internal Media of your CLIÉ handheld, even if you perform a hard reset, the data and applications are retained.

Notes

- The following applications or data cannot be backed up with the HotSync® operation.
 - Applications or data beamed or transferred from a “Memory Stick” media.
 - Certain applications or driver files added later, or certain data in an applicationFor details on applications that cannot be backed up, refer to the manual of each application.
- If you restore data by the HotSync® operation, perform a HotSync promptly after performing a hard reset. If data is created on your CLIÉ handheld before performing the HotSync® operation, the new data may be lost at the data restoration.
- If you customize settings in the **Change HotSync Action** dialog box, you may not be able to create a back up file. You cannot back up an application or restore its data if an option other than “Synchronize the files” is selected.
 - ➔ For details, refer to “Customizing HotSync® application settings (Conduit)” on page 112.

Tip

If you restore a file or back up a file, use the copy function of “CLIE Files”.

- ➔ For details, refer to “Exchanging data via storage media” on page 138.

Protecting your data with a password

This chapter explains how to manage your personal details using the various applications of your CLIÉ handheld and how to protect your data with a password.

Entering personal information	174
Locking your CLIÉ handheld with a password (Data protection)	176
Turning off your CLIÉ handheld after locking	176
Setting your CLIÉ handheld to be locked automatically	178
Protecting data	179
Assigning a password	179
Changing or deleting a password	180
Hiding or masking private data	181

Entering personal information

You can enter personal information, such as name, company name, and telephone number in your CLIÉ handheld. If you assign a password, the personal information will be displayed when your CLIÉ handheld is turned on next time.

- 1 Rotate the Jog Dial™ navigator to select  (Prefs) on the CLIE 3D Launcher and press the Jog Dial™ navigator. The **Preferences** screen is displayed.

Tip

You can also tap  (Prefs) to display the **Preferences** screen.

- 2 Tap ▼ at the top right of the **Preferences** screen, and select [Owner].
The **preferences** screen for Owner is displayed.

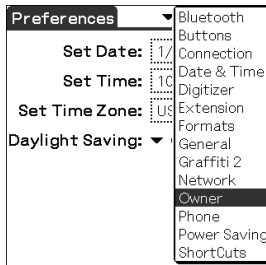

- 3 Enter your personal information.
When character strings entered do not fit within the screen, a scroll bar is displayed on the right of the screen.

Continued on next page

If you have already assigned a password to protect your data

If personal information is already protected, it cannot be entered or edited. To enter/edit personal information, follow the steps below to unlock the protection.

- 1 Rotate the Jog Dial™ navigator to select  (Prefs) on the CLIE 3D Launcher and press the Jog Dial™ navigator. The **Preferences** screen is displayed.

Tip

You can also tap  (Prefs) to display the **Preferences** screen.

- 2 Tap ▼ at the top right of the **Preferences** screen, and select [Owner]. The **preferences** screen for Owner is displayed.
- 3 Tap [Unlock]. The **Unlock Message** dialog box is displayed.



- 4 Enter the assigned password and tap [OK].

Locking your CLIÉ handheld with a password (Data protection)

You can lock your CLIÉ handheld by assigning a password. Your CLIÉ handheld then requires the user to enter the password when it is turned on.

Note

To turn on your CLIÉ handheld when it is locked, you must enter the correct password. If you forget the password, you need to perform a hard reset. However, performing a hard reset deletes all the data and applications which you installed on your CLIÉ handheld. (By performing the HotSync® operation, you can restore the backup data or applications from your computer. And, When you stored data and applications in the Internal Media of your CLIÉ handheld, even if you perform a hard reset, the data and applications are retained.)

- For details on how to reset your CLIÉ handheld, refer to “Basic operations of your CLIÉ™ handheld: Restarting your CLIÉ handheld” of the “Read This First (Operating Instructions)”.

Turning off your CLIÉ handheld after locking

This feature locks and turns off your CLIÉ handheld. To turn on your CLIÉ handheld, you must enter the correct password.

- 1 Perform the HotSync® operation between your computer and CLIÉ handheld to create backup data from your CLIÉ handheld to your computer.
 - For details on the HotSync® feature, refer to “Backing up data and applications to your computer with the HotSync® operation” on page 172.
- 2 Rotate the Jog Dial™ navigator to select  (Security) on the CLIÉ 3D Launcher and press the Jog Dial™ navigator. The **Security** screen is displayed.

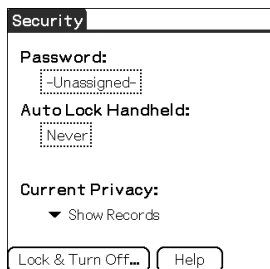

Tip

You can also tap  (Security) to display the **Security** screen.

Continued on next page

Locking your CLIÉ handheld with a password (Data protection)

- 3 Follow “Assigning a password” on page 179 to assign a password.
- 4 Tap [Lock & Turn Off].
The **System Lockout** screen is displayed.

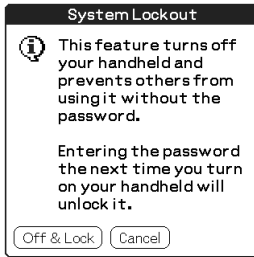

- 5 Tap [Off & Lock].
Your CLIÉ handheld turns off and locks.
To turn on your CLIÉ handheld, you must enter the correct password.

Setting your CLIÉ handheld to be locked automatically

You can set a time for your CLIÉ handheld to be locked automatically.

- 1 Follow steps 1 to 3 of “Turning off your CLIÉ handheld after locking” on page 176.
- 2 Tap [Never].
The **Password** screen is displayed.
- 3 Enter the password and tap [OK].
The **Lock Handheld** screen is displayed.

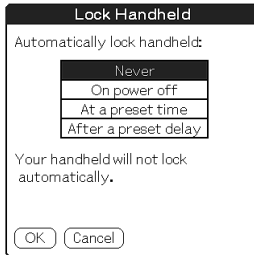

- 4 Tap your choice from the list on the **Lock Handheld** screen.
 - **Never:** Your CLIÉ handheld is not locked automatically.
 - **On power off:** Your CLIÉ handheld is locked when it is turned off.
 - **At a preset time:** Sets a time for your CLIÉ handheld to be locked automatically.
 - **After a preset delay:** Sets a time for your CLIÉ handheld to be locked automatically if it is inactive for a preset time interval.
- 5 Tap [OK].

Protecting data

You can protect your data from unauthorized users by assigning a password. Additionally, you can create private data which will not be shown even if a password is entered.

Assigning a password

You can assign a password to protect your private data or to lock your CLIE handheld.

- 1 Rotate the Jog Dial™ navigator to select  (Security) on the CLIE 3D Launcher and press the Jog Dial™ navigator. The **Security** screen is displayed.

Tip

You can also tap  (Security) to display the **Security** screen.

- 2 Tap [-Unassigned-].
The **Password** dialog box is displayed.

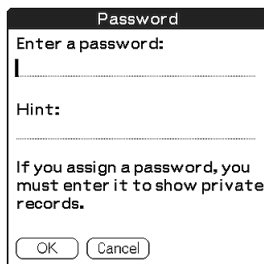

- 3 Enter a password.
Enter up to 29 alphanumeric characters (in the range a-z, 0-9).
- 4 Tap [OK].
The **Password** dialog box is displayed.
- 5 Enter the password once again to verify it and tap [OK].
Your password is assigned and **-Assigned-** is displayed on the screen in step 2.

Continued on next page

Tip

In step 3, you can enter a hint to remember your password. The hint will be displayed to remind you of the correct password if you enter an incorrect password.

..... Changing or deleting a password

You can change or delete the assigned password.

- 1** Rotate the Jog Dial™ navigator to select  (Security) on the CLIE 3D Launcher and press the Jog Dial™ navigator. The **Security** screen is displayed.

Tip

You can also tap  (Security) to display the **Security** screen.

- 2** Tap [-Assigned-].
The **Password** dialog box is displayed.
- 3** Enter the current password and tap [OK].
The **Password** dialog box is displayed.
- 4** Enter a new password and tap [OK].
To delete the password, tap [Unassign].

If you forget your password

If you forget your password, you can delete it forcibly. However, note that deleting the password forcibly also deletes all your private data. (If you perform the HotSync® operation to synchronize with your computer, you can restore your private data that has been backed up.)

- 1** In the above step 2, tap [Lost Password].
The **Delete Password** dialog box is displayed.
- 2** Tap [Yes].
Your password and private data are deleted.

Hiding or masking private data

You can choose to hide or mask your private data in applications such as **Address Book** or **Memo Pad**. To view the private data, you need to enter the password. Even if the data is invisible, it is saved.

- 1 Rotate the Jog Dial™ navigator to select  (Security) on the CLIE 3D Launcher and press the Jog Dial™ navigator. The **Security** screen is displayed.

Tip

You can also tap  (Security) to display the **Security** screen.

- 2 Tap ▼ under [Current Privacy] to select [Mask Records] or [Hide Records]. The **Mask Records** screen or **Hide Records** screen is displayed.

- 3 Tap [OK].
The private data becomes invisible.

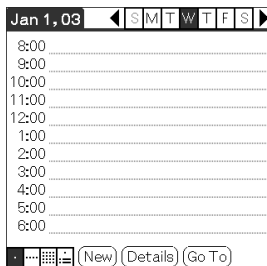

When you select [Hide Records]

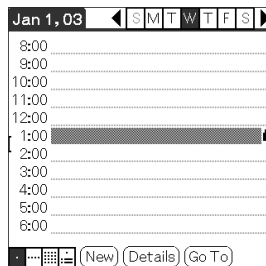

When you select [Mask Records]

Enhancing features with add-on applications

This chapter explains how to enhance features of your CLIE handheld by installing applications from your computer, Internet and storage media such as “Memory Stick” media.

Enhancing features with add-on applications	183
Installing	184
Installing from your computer	184
Installing applications on storage media	186
Installing from the Internet	186
Deleting installed add-on applications	187

Enhancing features with add-on applications

To install the applications from the supplied CD-ROM, refer to “Using applications” of the “Read This First (Operating Instructions)”.

You can enhance the features of your CLIÉ handheld by installing applications such as games or other application that run on Palm OS (Add-on applications). For the latest information on the applications that can be used in your CLIÉ handheld, refer to your CLIÉ handheld support website.

For details of the website, refer to the URL shown on the last page of this manual.

Note

As add-on applications installed on your CLIÉ handheld are temporarily saved on the memory, the add-on applications will be deleted when a hard reset is performed. In this case, you would need to reinstall them on your CLIÉ handheld. (When you stored data and applications in the Internal Media of your CLIÉ handheld, even if you perform a hard reset, the data and applications are retained.)

Installing from your computer

You can install the applications of your computer into your CLIÉ handheld.

For details on how to install the applications or data that are supplied with your CLIÉ handheld, refer to “Using applications” of the “Read This First (Operating Instructions)”.

- 1 Double click  (Palm Desktop for CLIÉ) on the Windows desktop.
You can also click [Start], select [Programs] (for Windows XP, select [All Programs]) - [Sony Handheld], and click [Palm Desktop for CLIÉ].
Palm™ Desktop for CLIÉ starts.

- 2 Click [Install].
The **Install Tool** window is displayed.



- 3 Select the user from [User].
- 4 Click [Add].
The **Open** dialog box is displayed.
The supplied applications or data are saved in the directory: Program Files/Sony Handheld/Add-on.

Continued on next page

5 Select applications you want to install from the folder and click [Open].

A list of the selected applications is displayed on the **Install Tool** window. Click [Remove] to delete applications that you do not want to install. The applications will be deleted from the list, but not from your computer.

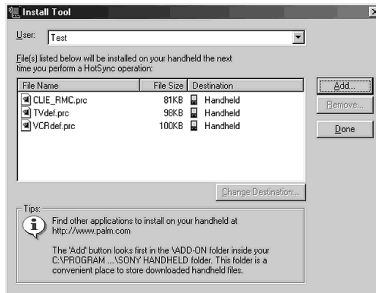

6 Click [Done].

The confirmation window is displayed.

7 Click [OK].

8 Perform the local HotSync® operation.

The applications selected in step 5 are installed into your CLIE handheld.

➔ For details on the local HotSync® operation, refer to “Performing the HotSync® operation” on page 65.

Displaying the Install Tool window directly from the Start menu in Windows

To display the **Install Tool** window, click [Start], select [Programs] (for Windows XP, select [All Programs]) - [Sony Handheld], and click [Installation Tool]. You can also double-click files that can be installed, such as .prc or .pdb format files.

Installing applications on storage media

Applications can be installed on storage media such as “Memory Stick” media. After step 5 of “Installing from your computer”, click [Change Destination]. Select the application and click either >> or << to specify **Memory Stick** for the location to save the application.

Notes on installing applications on storage media:

Do not start applications supplied with your CLIÉ handheld from Internal Media or “Memory Stick” media.

In some applications, related files, such as image files or movie files, cannot be opened (played back).

In the procedure mentioned above, select storage media and install the data or application onto the storage media you select by the HotSync® operation. They are installed in **/Palm/Launcher** directory. Some applications only support data in the designated directory. The data installed in **/Palm/Launcher** directory on storage media by the HotSync® operation cannot be displayed in those applications.

In this case, delete the data or applications from the storage media using **CLIE Files**.

Installing from the Internet

You can download applications from the CLIÉ handheld support website and install them on your CLIÉ handheld.



For details of the website, refer to the URL shown on the last page of this manual.

- 1** Download the applications you want to install in your computer, from the Internet.
- 2** Follow the instructions including readme files to install the downloaded application in your CLIÉ handheld.
If there are no specific instructions, double-click the downloaded PRC format (.prc) file and perform step 6 through 8 of “Installing from your computer” on page 184.

Deleting installed add-on applications

Tip

You can only delete the applications that you installed yourself. Default applications, such as **Address Book** and **Memo Pad**, cannot be deleted.

- 1 Tap  (Home).
The CLIE 3D Launcher is displayed.
- 2 Tap  (Menu).
The menu is displayed.
- 3 Tap [Delete...] from [CLIE 3D Launcher].
The **Delete** screen is displayed.

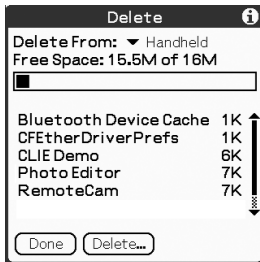

- 4 Tap ▼ next to [Delete From:] to select [Handheld] or storage media.
- 5 Tap the application you want to delete and tap [Delete...].
A confirmation message is displayed.

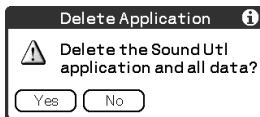

- 6 Tap [Yes].
The application selected in step 5 is deleted.
To cancel deleting, tap [No].
- 7 Tap [Done].
The **CLIE 3D Launcher** is displayed.



Transferring data from another CLIÉ™ handheld

This chapter explains how to transfer data from your CLIÉ handheld to another CLIÉ handhelds.

Transferring data from another CLIÉ™ handheld	189
Transferring data using Palm™ Desktop for CLIÉ	189

Transferring data from another CLIÉ™ handheld

Notes

- You cannot transfer applications that you installed. You need to reinstall them to your CLIÉ handheld.
- Some third party applications may operate only on your old CLIÉ handheld. For details, contact the application manufacturer.

Transferring data using Palm™ Desktop for CLIÉ

For data of the basic Palm OS® applications such as **Date Book**, **Address**, **To Do List**, and **Memo Pad**, you can use **Palm™ Desktop for CLIÉ** to transfer data from your old CLIÉ handheld to your new CLIÉ handheld, by exporting and importing data.



Note

To transfer data from your old CLIÉ handheld to your new CLIÉ handheld, use the palm™ Desktop for CLIÉ supplied with your new CLIÉ handheld, and perform the HotSync operation with your old CLIÉ handheld. And in this case, it requires that the user names of both your CLIÉ handheld is not the same.

Continued on next page

Exporting data from your old CLIÉ handheld to your computer

You can export the data of **Date Book**, **Address**, **To Do List**, and **Memo Pad** to your computer from your old CLIÉ handheld.

Note

Operate the following, after installing the Palm™ Desktop for CLIÉ supplied with your new CLIÉ handheld to your computer.

- 1 Connect your old CLIÉ handheld to your computer, and perform the HotSync operation.
- 2 Double-click  (Palm Desktop for CLIÉ) on your Windows desktop.
Palm™ Desktop for CLIÉ starts.

Tip

You can also click [Start], select [Programs] (for Windows XP, select [All Programs]) - [Sony Handheld], and click [Palm Desktop for CLIÉ].

- 3 Select the user name of your previous CLIÉ handheld from the list at the top right of the screen.
- 4 Click the **Date Book** icon at the left side of the window.
The display is changed to the **Date Book** window.
- 5 Click [Export], from [File].
The Export file window is displayed.
- 6 Enter the file name and click [Export].
The data of your old CLIÉ handheld is exported.
Change the location to save the application as needed.
- 7 Repeat step 4 through 6 to export data of other applications.

Continued on next page

Importing data to your new CLIÉ handheld from your computer

You can import the data of **Date Book**, **Address**, **To Do List**, and **Memo pad** from your computer to your new CLIÉ handheld.

- 1 Select the user name of your new CLIÉ handheld from the list at the top right of the screen.

Tip

If you have never performed the HotSync® operation with your new CLIÉ handheld, select [Users] from [Tools]. Click [New] in the **Users** window and enter the new user name.

Then select the user name you just entered.

- 2 Click [Import], from [File].
- 3 Select the files you have exported, and click [Open].
- 4 Perform the HotSync® operation.
The data exported from your old CLIÉ handheld is copied onto your new CLIÉ handheld.

Do not perform the HotSync® operation with the same user name of other CLIÉ handhelds

If you perform the HotSync® operation between your new CLIÉ handheld and **Palm™ Desktop for CLIÉ** for your old CLIÉ handheld, and use the old user name, then setup information specific to the old CLIÉ handheld will be transferred with data. This may cause some problems. Similarly, if you try performing the HotSync® operation with your old CLIÉ handheld, problems may also arise. Do not transfer data by this method.

The screen to select the user name is displayed when performing the HotSync® operation in your CLIÉ handheld

Enter a name that is different from the user name of your CLIÉ handheld being used. If the same user name is used, **Palm™ Desktop for CLIÉ** will not recognize your CLIÉ handheld properly and the data of the respective models will be mixed or deleted.

Moreover, if you copy **Unsaved Preferences** from another CLIÉ handheld to your CLIÉ handheld, you will not be able to manage your CLIÉ handheld with another name, since the user name is also copied.

Continued on next page

Note on performing the HotSync® operation on another CLIÉ handheld

When using a new CLIÉ handheld, install **Palm™ Desktop for CLIÉ** supplied with the newly purchased CLIÉ handheld. Before installing the new **Palm™ Desktop for CLIÉ**, uninstall the old **Palm™ Desktop for CLIÉ** being used, from your computer.

INDEX

A

Application

- Add-on applications 183
 - Deleting the add-on applications . . . 187
 - Enhancing the features 183
 - Installing applications on
storage media 186
 - Installing from the Internet 186
 - Installing from your computer 184
 - Quitting 16
 - Starting 14
- Application buttons 96
- Archive 64, 114
- Automatic power-off time 98

B

Backing up data

- Backing up data and applications to
your computer with the HotSync®
operation 172

Basic operations 10

Beam Receive feature

- Beaming 154
- IR HotSync 123
- Receiving 156
- What you can do 153

Bluetooth® function

- Communicating with a Bluetooth®
compatible mobile phone 160
- Exchanging files/data 158
- HotSync® operation using
the Bluetooth® function 119
- Performing the wireless HotSync®
operation with a computer 159
- Setting 73
- Turning on or off 73
- What you can do 158

- Brightness 97
- Buttons 96, 97

C

Calculator

- Calculating 166
- functions of the Calculator buttons . . . 167
- Using the Calculator menus 168

CLIE 3D Launcher

- Application manager icon 24
- CLIE 3D Launcher group 18
- Creating a new group 20
- Deleting a group 21
- Displaying information about
applications 25
- Locating the components 17
- Menu List 26
- Ordering listed groups 20
- Selecting a group 21
- Using Favorite Applications (shortcuts) . . 22

CLIE Files

- Copying files/data on storage media
to your CLIE handheld 143
- Copying your CLIE handheld
files/data to storage media 140
- Deleting files/data on
storage media 145
- Exchanging files/data without
using CLIE Files 150
- Menu items 149
- Starting 138

Common menu items 38

Communication device 107

Conduit 112

Connection 107

Customizing the full-screen pen stroke activities 97

D

Data protection	176
Date	103
Date Book	59
Decuma Input	40, 54
Digitizer	78
Dragging	11

E

Entering text	
Graffiti [®] 2 writing	41
Using Decuma Input	54

F

File Link	114
Finding	169
Fonts	37
Formats	103

G

General	98, 99, 100, 101
Graffiti [®] 2 writing	
Graffiti [®] 2 writing area	51
Using Navigation strokes and shortcuts	52
What is Graffiti [®] 2 writing?	41

H

Hide Records	181
Home screen	
CLIE 3D Launcher	15
Palm OS Standard screen	27
HotSync	
Customizing HotSync [®] application settings (Conduit)	112

Customizing HotSync [®] Manager startup and HotSync [®] setup options	115
Performing the HotSync [®] operation	65
Performing the HotSync [®] operation using the Bluetooth [®] function	119
Performing the HotSync [®] operation via a wireless LAN (for PEG-UX50 only)	116
Performing the HotSync [®] operation via LAN (LANSync)	126
Performing the HotSync [®] operation with the USB cable (Local HotSync [®])	65
Performing the IR HotSync [®] operation	123
Synchronizing with external data (File Link)	114
What is the HotSync [®] operation?	63

I

Internal Media	130
IR port	26, 123, 153

J

Jog Dial™ navigator	12
---------------------	----

L

LANSync	126
Locking	176
Log-in scripts	92

M

Mask Records	181
“Memory Stick” media	
Protecting the files/data on “Memory Stick” media	132
Using “Memory Stick” media	130

N

Network	85
Network Log	95
Numbers	
Selecting a regional default	103

O

Owner	174
-------------	-----

P

Palm™ Desktop for CLIE software	
Basic operations	69
Locating components	68
Starting	67
Transferring data from another CLIE handheld	189
Password	
Changing or deleting	180
If you forget your password	180
Power Saving Mode	71
Preferences	
Bluetooth	73
Buttons	96, 97
Connection	107
Date & Time	108
Digitizer	78
Formats	103
General	98, 99, 100, 101
Network	85
Owner	174
ShortCuts	77
Private data	179
Protecting	179

S

Service template	85, 89, 91
Setting up the Date & Time preferences	108
ShortCuts	17, 52, 77
Sounds	99
Storage media	
Assigning a name	135
Exchanging files/data	138
Formatting	136
Starting an application	133
The type of storage media you can use with your CLIE handheld	130
Viewing information	134
Stylus	10

T

Tapping	11
Time	103
Transferring data	189

U

User name	112, 116
Using Favorite Applications (shortcuts)	
Creating	22
Deleting	23
Using the Palm OS® Standard screen	
Changing the display style of the Palm OS® Standard screen	33
Starting an application	29
Switching to the CLIE 3D Launcher screen	28

V

View Log	95
-----------------------	----

W

Wireless LAN (for PEG-UX50 only)

Adhoc mode	79
Checking the wireless LAN communication status	83
Connecting your CLIÉ handheld to a wireless LAN access point automatically	82
Searching and setting a wireless LAN access point manually	81
Setting a wireless LAN access point manually	79
Setting the Network preferences for a wireless LAN (for PEG-UX50 only) . . .	79



For the latest information on support
and accessories,
check our official Sony CLIE website

For customers in the U.S.A. and Canada
<http://www.sony.com/clie/>

For customers in Australia, Hong Kong, Malaysia,
Mexico, New Zealand, Singapore, Taiwan and
Thailand
<http://vaio-online.sony.com/clie/>